

Vysapuri, Bandlaguda
Post:Keshavgi, Hyderabad- 500005,
Telangana, INDIA
Tel: 040-29880086,8978380692,Fax:040-24550033
E-mail: principal@mist.ac.in
principal.mahaveer@gmail.com,
Website: www.mist.ac.in,

MAHAVEER
INSTITUTE OF SCIENCE & TECHNOLOGY
Approved by AICTE, Affiliated to JNTUH,Hyd.



Counseling Code: **MHVR**, University Code: **E3**

7.2.1 I. BEST PRACTICES- NSS

The Practice:

MIST has deployed many practices to enhance Societal Empowerment among our students through various activities.

Vysapuri, Bandlaguda Post:Keshavgi,
Hyderabad-500 005, TELANGANA INDIA
Tel: 040-64596979,8978380692,
Fax: 040-24455003
E-mail: principal.mahaveer@gmail.com
Website: www.mist.ac.in,

MAHAVEER

Approved by AICTE, Affiliated to JNTUH,Hyd.



INDEX

NSS ACTIVITIES FOR THE AY 2016-17

S.NO	EVENT	DATE
1	Swach Bharath	18-06-2016
2	Haritha Haram	11-07-2016
3	Blood donation Camp	25-12-2016
4	Swami Vivekananda Pushpanjali Programme	09-01-2017
5	2k RUN	15-03-2017

K. S. S.
PRINCIPAL
MAHAVEER
INSTITUTE OF SCIENCE & TECHNOLOGY
Bandlaguda, Hyd-500 005.

Vysapuri, Bandlaguda Post:Keshavgiri,
Hyderabad-500 005, TELANGANA INDIA
Tel: 040-64596979,8978380692,
Fax: 040-24455003
E-mail: principal.mahaveer@gmail.com,
Website: www.mist.ac.in,

MAHAVEER

Approved by AICTE, Affiliated to JNTUH,Hyd.



Date: 15-06-2016

CIRCULAR

Sub: SWACH BHARATH

All the faculty members and students are here by informed that "SWACH BHARATH" will be organized by NSS unit of Mahaveer Institute Of Science and Technology is scheduled on **18th JUNE 2016** between 9.30AM to 2.00PM at Mailardevalapally near Mahaveer Institute of Science and Technology. All NSS volunteers are requested to participate this event.

Copy to:
All Hod's, Principal
polytechnic, Exam
Branch incharge,
Librarian

K. Suresh
PRINCIPAL
MAHAVEER
INSTITUTE OF SCIENCE & TECHNOLOGY
Bandlaguda, Hyd-500 005.

K. Suresh
PRINCIPAL

Vysapuri, Bandlaguda Post:Keshavgi,
Hyderabad-500 005, TELANGANA INDIA
Tel: 040-64596979,8978380692,
Fax: 040-24455003
E-mail: principal.mahaveer@gmail.com
Website: www.mist.ac.in,

MAHAVEER
INSTITUTE OF SCIENCE & TECHNOLOGY
Approved by AICTE, Affiliated to JNTUH,Hyd.



Dt:18-06-2016

Programme 1: Swachh Bharath

This programme was organized by Mahaveer Institute of Science and Technology at Mailardevulapally Near Mahaveer Institute Of Science And Technology in this programme all the NSS volunteers and NSS programme officer were participated.



K. Srinivas
PRINCIPAL
MAHAVEER
INSTITUTE OF SCIENCE & TECHNOLOGY
Bandlaguda, Hyd-500 005

Vysapuri, Bandlaguda Post:Keshavgiri,
Hyderabad-500 005, TELANGANA INDIA
Tel: 040-64596979,8978380692.
Fax: 040-24455003
E-mail: principal.mahaveer@gmail.com
Website: www.mist.ac.in,

MAHAVEER
INSTITUTE OF SCIENCE & TECHNOLOGY
Approved by AICTE, Affiliated to JNTUH,Hyd.



K. S. Mahaveer
PRINCIPAL
MAHAVEER

Vysapuri, Bandlaguda Post:Keshavgi,
Hyderabad-500 005, TELANGANA INDIA
Tel: 040-64596979,8978380692,
Fax: 040-24455003
E-mail: principal.mahaveer@gmail.com
Website: www.mist.ac.in,

MAHAVEER

Approved by AICTE, Affiliated to JNTUH,Hyd.



Dt: 18-06-2016

EVENT NAME: SWACH BHARATH

Student participation list

S NO	STUDENT NAME	BRANCH	YEAR
1.	MEKALA BATHALA MAHESH	AERO	IV
2.	AMBALA RAJKUMAR	CIVIL	IV
3.	GOPIREDDY SOMASHEKAR REDDY	CIVIL	IV
4.	ALE SANATH KUMAR	CSE	IV
5.	K RAHUL	CSE	IV
6.	PULAKANTI KRISHNA SAI	CSE	IV
7.	K.SANDEEP KUMAR	ECE	IV
8.	KODIPELLY VINISHA	ECE	IV
9.	GANGULA SRINIVAS	MECH	IV
10.	AREKATLA DIVYA	IT	III
11.	AYESHA BEGUM	CSE	III
12.	PALLAPU JYOTHI	CSE	III
13.	C SAI KIRAN	MECH	III
14.	MA RAHEMAN	MECH	III
15.	S POOJA	EEE	III
16.	BHUPATHI HARIKA	EEE	III
17.	BOMMIDI NAVEEN	CIVIL	II
18.	C UMA	ECE	II
19.	KASARLA RANI	ECE	II
20.	VILASAGARAM HARISH	ECE	II
21.	KOONARAPU AKHIL	EEE	II

K. S. S.
PRINCIPAL
MAHAVEER
INSTITUTE OF SCIENCE & TECHNOLOGY
Bandlaguda, Hyd-500 005.

Vysapuri, Bandlaguda Post:Keshavgi,
Hyderabad-500 005, TELANGANA INDIA
Tel: 040-64596979,8978380692,
Fax: 040-24455003
E-mail: principal.mahaveer@gmail.com
Website: www.mist.ac.in,

MAHAVEER

Approved by AICTE, Affiliated to JNTUH,Hyd



Dt: 18-06-2016

EVENT NAME: SWACH BHARATH

ORGANIZING COMMITTEE

Student organizing members:

S NO	STUDENT NAME	BRANCH	year
1	GANGULA SRINIVAS	MECH	IV
2	GOPIREDDY SOMASHEKAR REDDY	CIVIL	IV
3	PULAKANTI KRISHNA SAI	CSE	IV

Faculty organizing members:

S NO	NAME OF THE FACULTY	DESIGNATION	DEPT
1	DR.M VASANTHA LAXMI	ASSOCIATE PROFERSOR	CIVIL

K. Sankar
PRINCIPAL
MAHAVEER
INSTITUTE OF SCIENCE & TECHNOLOGY
Bandlaguda, Hyd-500 005.

Vysapuri, Bandlaguda Post:Keshavgiri,
Hyderabad-500 005, TELANGANA INDIA
Tel: 040-64596979,8978380692,
Fax: 040-24455003
E-mail: principal.mahaveer@gmail.com,
Website: www.mist.ac.in,

MAHAVEER

Approved by AICTE, Affiliated to JNTUH,Hyd.



Date: 8-7-2016

CIRCULAR

Sub: Haritha Haram

All the faculty members and students are here by informed that “**Haritha Haram**” will be organised by NSS unit of Mahaveer Institute Of Science and Technology in Association is scheduled on **11th JULY 2016** between 9.30AM to 2.00PM in our college campus. Students, teaching and non-teaching staff members are requested to participate this event.

PRINCIPAL

Copy to:

All Hod's, Principal
polytechnic, Exam
Branch incharge,
Librarian

PRINCIPAL
MAHAVEER
INSTITUTE OF SCIENCE & TECHNOLOGY
bandlaguda, Hyd-500 005.

Vysapuri, Bandlaguda Post:Keshavgiri,
Hyderabad-500 005, TELANGANA INDIA
Tel: 040-64596979,8978380692,
Fax: 040-24455003
E-mail: principal.mahaveer@gmail.com
Website: www.mist.ac.in,

MAHAVEER
INSTITUTE OF SCIENCE & TECHNOLOGY
Approved by AICTE, Affiliated to JNTUH,Hyd.



Dt:11-07-2016

Programme 2: Haritha Haram

Haritha Haram programme was conducted in the month of JULY at MIST college campus. Sri S Sudharshan Reddy Chairmen of Mahaveer Institute of Science and Technology, Sri S. Surender Reddy secretary of Mahaveer Institute of science and technology, Principal Dr.K.S.S.S.N Reddy garu, NSS volunteers and faculty members actively participated in the programme. sapling were collected from State forest department.



K. S. S. S. N
PRINCIPAL

Vysapuri, Bandlaguda Post:Keshavgiri,
Hyderabad-500 005, TELANGANA INDIA
Tel: 040-64596979,8978380692,
Fax: 040-24455003
E-mail: principal.mahaveer@gmail.com
Website: www.mist.ac.in,

MAHAVEER
INSTITUTE OF SCIENCE & TECHNOLOGY
Approved by AICTE, Affiliated to JNTUH,Hyd.



K. S. S. S.
PRINCIPAL

Vysapuri, Bandlaguda Post:Keshavgiri,
Hyderabad-500 005, TELANGANA INDIA
Tel: 040-64596979,8978380692,
Fax: 040-24455003
E-mail: principal.mahaveer@gmail.com
Website: www.mist.ac.in,

MAHAVEER

Approved by AICTE, Affiliated to JNTUH,Hyd.



Dt:11-07-2016

EVENT NAME: HARITHA HARAM

ORGANIZING COMMITTEE

Student organizing members:

S NO	STUDENT NAME	BRANCH	year
1	NAKKA CHAITANYA	CSE	II
2	BATOJU MAHESH CHARY	ECE	II
3	ANAND KUMAR	MECH	II
4	TUNIKI SHIVAKUMAR	IT	II

Faculty organizing members:

S NO	NAME OF THE FACULTY	DESIGNATION	DEPT
1	DR.M VASANTHA LAXMI	ASSOCIATE PROFESSOR	CIVIL

PRINCIPAL
MAHAVEER
INSTITUTE OF SCIENCE & TECHNOLOGY
Bandlaguda, Hyd-500 005.

Vysapuri, Bandlaguda Post: Keshavgi,
Hyderabad-500 005, TELANGANA INDIA
Tel: 040-64596979,8978380692,
Fax: 040-24455003
E-mail: principal.mahaveer@gmail.com
Website: www.mist.ac.in,

MAHAVEER

Approved by AICTE, Affiliated to JNTUH, Hyd.



22.	ATTLURI SURESH REDDY	MECH	II
23.	BURRA AJAY	MECH	II

K. Suresh

PRINCIPAL
MAHAVEER
INSTITUTE OF SCIENCE & TECHNOLOGY
Bandlaguda, Hyd-500 005.

Vysapuri, Bandlaguda Post:Keshavgi,
Hyderabad-500 005, TELANGANA INDIA
Tel: 040-64596979,8978380692,
Fax: 040-24455003
E-mail: principal.mahaveer@gmail.com
Website: www.mist.ac.in,

MAHAVEER

Approved by AICTE. Affiliated to JNTUH,Hyd



Dt:11-07-2016

Event Name: Haritha Haram

Student participation list

S NO	STUDENT NAME	BRANCH	YEAR
1.	NAKKA CHAITANYA	CSE	II
2.	GOULIKAR SUSHMA	CSE	II
3.	KAMPA SRUTEJA	CSE	II
4.	AFRIN	CSE	II
5.	NIBHANUPUDY CHAITANYA MURALI	CSE	II
6.	POTLA SIDDARTHA	CSE	II
7.	AKULA SHUCHENDRA	ECE	II
8.	DOSADA SOWMYA	ECE	II
9.	GODEM MOUNIKA	ECE	II
10.	MADYALA GANESH	ECE	II
11.	NANGUNURI VISHNU	ECE	II
12.	BATOJU MAHESH CHARY	ECE	II
13.	KALE SANDEEP	ECE	II
14.	KOLANUPAKA AJAY GOUD	ECE	II
15.	R INDUPRIYA	CSE	II
16.	POREDDY NIHARIKA	CSE	II
17.	SHEELAM NIKHIL SAI	CSE	II
18.	POSHETTY MANISHA	IT	II
19.	TUNIKI SHIVAKUMAR	IT	II
20.	KURUKUNTLA HARISH SAGAR	IT	II
21.	ANAND KUMAR	MECH	II

K. Sankar
PRINCIPAL
MAHAVEER
INSTITUTE OF SCIENCE & TECHNOLOGY
Bandlaguda, Hyd-500 005.

Vysapuri, Bandlaguda Post:Keshavgiri,
Hyderabad-500 005, TELANGANA INDIA
Tel: 040-64596979,8978380692,
Fax: 040-24455003
E-mail: principal.mahaveer@gmail.com,
Website: www.mist.ac.in,

MAHAVEER

Approved by AICTE, Affiliated to JNTUH,Hyd.



Date: 22-12-2016

CIRCULAR

Sub: BLOOD DONATION CAMP

All the faculty members and students are here by informed that "BLOOD DONATION CAMP" will be organized by NSS unit of Mahaveer Institute Of Science and Technology is scheduled on 25th DECEMBER 2016 on the occasion of Atal bihari Vajpayee birth celebration between 9.30AM to 2.00PM at LCH colony community hall saidabad Hyderabad.All the Students, teaching and non-teaching staff members are requested to participate in this event.

PRINCIPAL

Copy to:
All Hod's, Principal
polytechnic, Exam
Branch incharge,
Librari

PRINCIPAL
MAHAVEER
INSTITUTE OF SCIENCE & TECHNOLOGY
Bandlaguda, hyd-500 005.

Vysapuri, Bandlaguda Post:Keshavgi,
Hyderabad-500 005, TELANGANA INDIA
Tel: 040-64596979,8978380692,
Fax: 040-24455003
E-mail: principal.mahaveer@gmail.com
Website: www.mist.ac.in,

MAHAVEER
INSTITUTE OF SCIENCE & TECHNOLOGY
Approved by AICTE, Affiliated to JNTUH,Hyd.



Dt:25-12-2016

Programme 3: Blood donation Camp

This programme was organized by NSS UNIT Mahaveer Institute Of Science And Technology on the occasion of Bharat Ratna "ATAL BIHARI VAJPAYEE" birthday celebrations on December 25th 2016 at LCH colony community hall saidabad colony Hyderabad. So many students and faculty members were participated in this event and they donated blood, after that fruits and fluids distributed to the blood donars.



K. Srinivas
PRINCIPAL
MAHAVEER

Vysapuri, Bandlaguda Post:Keshavgiri,
Hyderabad-500 005, TELANGANA INDIA
Tel: 040-64596979,8978380692,
Fax: 040-24455003
E-mail: principal.mahaveer@gmail.com
Website: www.mist.ac.in,

MAHAVEER
INSTITUTE OF SCIENCE & TECHNOLOGY
Approved by AICTE, Affiliated to JNTUH,Hyd.



K. Srinivas
PRINCIPAL

Vysapuri, Bandlaguda Post:Keshavgi,
Hyderabad-500 005, TELANGANA INDIA
Tel: 040-64596979,8978380692,
Fax: 040-24455003
E-mail: principal.mahaveer@gmail.com
Website: www.mist.ac.in,

MAHAVEER

Approved by AICTE, Affiliated to JNTUH,Hyd.



Dt:25-12-2016

EVENT NAME: BLOOD DONATION CAMP

ORGANIZING COMMITTEE

Student organizing members:

S NO	STUDENT NAME	BRANCH	year
1	ADUNUTULA VISHNUPREETH REDDY	CSE	III
2	GUMMALA SAI NISHANTH REDDY		
3	S NAGA NIKHIL	CSE	III
4	DEVARAMPALLY VISHAL	CSE	III
5	ALAKANTI ANIRUDH REDDY	CSE	III

Faculty organizing members:

S NO	NAME OF THE FACULTY	DESIGNATION	DEPT
1	Dr. M VASANTHA LAXMI	ASSOCIATE PROFESSOR	CIVIL

K. Sankar

PRINCIPAL
MAHAVEER
INSTITUTE OF SCIENCE & TECHNOLOGY
Bandlaguda, Hyd-500 005.

Vysapuri, Bandlaguda Post:Keshavgi,
Hyderabad-500 005, TELANGANA INDIA
Tel: 040-64596979,8978380692,
Fax: 040-24455003
E-mail: principal.mahaveer@gmail.com
Website: www.mist.ac.in,

MAHAVEER

Approved by AICTE, Affiliated to JNTUH,Hyd.



20.	D SAITEJA	ECE	II
21.	RENUKUNTA SAIRAM	ECE	II
22.	GILLALA PRANEETH REDDY	ECE	II
23.	NAMPALLY AJAY KUMAR	ECE	II
24.	ARVA SHASHANK	CSE	II
25.	BADAM SHARATH KUMAR	CSE	II
26.	BOBBALA ARAVIND REDDY	CSE	II
27.	BOBBILIGAMA NITHIN KUMAR GOUD	CSE	II
28.	KAMBHAM NAVEE REDDY	CSE	II
29.	RAIKODU RAVIKISHORE REDDY	CSE	II
30.	ARUTLA RAJGOPAL	IT	II
31.	DUMALA VENU	IT	II
32.	DHADI VIJAY	CIVIL	II
33.	ERUKULLA SRIKANTH	CIVIL	II
34.	SYEED SAMEER	CIVIL	II
35.	KOLLA SAITEJA	MECH	II
36.	REGULA ARAVIND	MECH	II
37.	T KULDEEP SINGH	MECH	II

K. S. S.

PRINCIPAL
MAHAVEER

INSTITUTE OF SCIENCE & TECHNOLOGY
Bandlaguda, Hyd-500 005.

Vysapuri, Bandlaguda Post:Keshavpuri,
Hyderabad-500 005, TELANGANA INDIA
Tel: 040-64596979,8978380692.
Fax: 040-24455003
E-mail: principal.mahaveer@gmail.com,
Website: www.mist.ac.in,

MAHAVEER

Approved by AICTE, Affiliated to JNTUH,Hyd.



Date: 06-01-2017

CIRCULAR

Sub: Swami Vivekananda Pushpanjali Programme

All the faculty members and students are here by informed that "Swami Vivekananda Pushpanjali Programme" will be organized by NSS unit of Mahaveer Institute Of Science and Technology is scheduled on 09th JANUARY 2017 between 9.30AM to 2.00PM in our college campus. Students, teaching and non-teaching staff members are requested to participate this event.

PRINCIPAL

PRINCIPAL
MAHAVEER
INSTITUTE OF SCIENCE & TECHNOLOGY
BANDLAGUDA, HYDRABAD - 500005

Copy to:

All Hod's, Principal
polytechnic, Exam
Branch incharge,
Librarian

Vysapuri, Bandlaguda Post:Keshavgiri,
Hyderabad-500 005, TELANGANA INDIA
Tel: 040-64596979,8978380692,
Fax: 040-24455003
E-mail: principal.mahaveer@gmail.com
Website: www.mist.ac.in,

MAHAVEER
INSTITUTE OF SCIENCE & TECHNOLOGY
Approved by AICTE, Affiliated to JNTUH,Hyd.



Dt:09-01-2017

Programme 4: Swami Vivekananda Pushpanjali Programme

This programme was conducted at Mahaveer Institute of Science and Technology on 09 January 2017 by NSS coordinators to motivate the students and get inspired by the great personalities of our nation the special guest of this day was Sri S Sudharshan Reddy Chairmen of Mahaveer Institute of Science and Technology, Sri S. Surender Reddy secretary of Mahaveer Institute of science and technology, Principal Dr.K.S.S.S.N Reddy garu, all the faculty and students of Mahaveer college were participated



K. S. S. S. N
PRINCIPAL
MAHAVEER
INSTITUTE OF SCIENCE & TECHNOLOGY

Vysapuri, Bandlaguda Post:Keshavgiri,
Hyderabad-500 005, TELANGANA INDIA
Tel: 040-64596979,8978380692,
Fax: 040-24455003
E-mail: principal.mahaveer@gmail.com
Website: www.mist.ac.in,

MAHAVEER
INSTITUTE OF SCIENCE & TECHNOLOGY
Approved by AICTE, Affiliated to JNTUH,Hyd.



Principal
PRINCIPAL
MAHAVEER
INSTITUTE OF SCIENCE & TECHNOLOGY

Vysapuri, Bandlaguda Post:Keshavgi,
Hyderabad-500 005, TELANGANA INDIA
Tel: 040-64596979,8978380692,
Fax: 040-24455003
E-mail: principal.mahaveer@gmail.com
Website: www.mist.ac.in,

MAHAVEER

Approved by AICTE, Affiliated to JNTUH,Hyd



Dt:09-01-2017

Event Name:Swami Vivekananda Pushpanjali Programme

ORGANIZING COMMITTEE

Student organizing members:

S NO	STUDENT NAME	BRANCH	YEAR
1.	S MAHENDER REDDY	CSE	II
2.	P.REETHIMA REDDY	CSE	II
3.	N.CHAITANYA	CSE	II
4.	N.VINAY	CSE	II
5.	BHS LAHARI	CSE	II
6.	G.RAJESH	CSE	II
7.	G.SANKEERTH	CSE	II
8.	SAI TEJA	ECE	II
9.	M.JAIPAL	ECE	II
10.	K.VISHNU	ECE	II
11.	PAVAN KUMAR	CIVIL	III
12.	KHUSHBHU DONGARE	CSE	III
13.	NISHANTH	CSE	III
14.	VISHNU	CSE	III

Faculty organizing members:

S NO	NAME OF THE FACULTY	DESIGNATION	DEPT
1	Dr M VASANTHA LAXMI	ASSOCIATE PROFERSOR	CIVIL

K. Sankar

PRINCIPAL
MAHAVEER
INSTITUTE OF SCIENCE & TECHNOLOGY
Bandlaguda, Hyd-500 005.

Vysapuri, Bandlaguda Post:Keshavgiri,
Hyderabad-500 005, TELANGANA INDIA
Tel: 040-64596979,8978380692,
Fax: 040-24455003
E-mail: principal.mahaveer@gmail.com,
Website: www.mist.ac.in,

MAHAVEER

Approved by AICTE, Affiliated to JNTUH,Hyd.



Date: 13-03-2017

CIRCULAR

Sub: 2K RUN

All the faculty members and students are here by informed that "2K RUN" will be organised on 15th MARCH 2017 between 8.00AM to 9.00AM to at "Tank Bund". All the interested Students are requested to participate in this event.

Copy to:

All Hod's, Principal
polytechnic, Exam
Branch incharge,
Librarian

K. S. S. S.
PRINCIPAL
MAHAVEER
INSTITUTE OF SCIENCE & TECHNOLOGY
Bandlaguda, Hyd-500 005.

K. S. S. S.

PRINCIPAL

Vysapuri, Bandlaguda Post:Keshavgi,
Hyderabad-500 005, TELANGANA INDIA
Tel: 040-64596979,8978380692,
Fax: 040-24455003
E-mail: principal.mahaveer@gmail.com
Website: www.mist.ac.in,

MAHAVEER
INSTITUTE OF SCIENCE & TECHNOLOGY
Approved by AICTE, Affiliated to JNTUH,Hyd.



Dt:15-03-2017

Programme 5: 2k RUN

This 2k Run Marathon was organized on March 15th 2017 at Tank Bund, so many students were participated in this 2k RUN Marathon, for this Mahaveer Students were also participated as part of NSS activity to make it grand success.



K. Srinivas
PRINCIPAL
MAHAVEER
INSTITUTE OF SCIENCE & TECHNOLOGY

Vysapuri, Bandlaguda Post:Keshavgiri,
Hyderabad-500 005, TELANGANA INDIA
Tel: 040-64596979,8978380692,
Fax: 040-24455003
E-mail: principal.mahaveer@gmail.com
Website: www.mist.ac.in,

MAHAVEER

Approved by AICTE, Affiliated to JNTUH,Hyd.



Dt:15-03-2017

Event Name:2K RUN

Student Participation List

S NO	STUDENT NAME	BRANCH	YEAR
1	SHIRISHA YADAV	EEE	II
2	SAI KIRAN REDDY	EEE	II
3	ABHISHEK	EEE	II
4	SHANKAR	EEE	II
5	A RASAGNYA	CSE	III
6	E ANUPRIYA	CSE	III
7	G DHRUVA MANASA	CSE	III
8	N AKHILENDRA	CSE	III
9	A PAVAN	IT	III
10	A BALAKRISHNA GOUD	ECE	III
11	A VENKATA KRISHNA VAMSHI	ECE	III
12	P SRIKANTH	ECE	II
13	RAGHAVENDRA	ECE	II
14	AMAR HUSSAIN	ECE	II
15	SAIRAM	ECE	II
16	A VINAY	ECE	II
17	KIRAN G	ECE	II
18	D SAI TEJA	ECE	II
19	B VASU	ECE	II
20	B SAI VARMA	ECE	III
21	G SAI TEJA	ECE	III
22	M SHIVARAM	ECE	III
23	G SURESH	EEE	III
24	M JAIPAL	ECE	III
25	SHAIK MOHAMMED RAYAN	MECH	III
26	SHAIK SOHAIL	MECH	III
27	MOHAMMED KHAN	MECH	III
28	SYED MUZAMT	MECH	III
29	MOHAMMED AJAZ KHAN	MECH	III
30	B KISHORE	MECH	III
31	P KRISHNA	MECH	III
32	N AKASH	MECH	III
33	J VAMSHI KRISHA	MECH	III
34	K SUSHMITHA	MECH	III
35	A PUSHPANJALI	MECH	III

K. S. S.

MAHAVEER INSTITUTE OF SCIENCE & TECHNOLOGY
Bandlaguda Post, Keshavgiri,
Hyderabad - 500 005

Mahaveer Institute of Science & Technology
 Hyderabad-500 005, T.S. INDIA
 Tel: 040-29580079, 040-29580080, 040-2701342
 9852716007, 9852734433 Website: www.mahaveer.in
 E-mail: mahaveer@mahaveer.in
 mahaveer@mahaveer.in
 www.mahaveer.in

MAHAVEER



Approved by AICTE, Affiliated to JNTU University, Hyd

INDEX

N.S.S ACTIVITIES FOR THE AY 2017-18

S.NO	EVENT	DATE
1	Sponsoring tribal child education Be good – Do good	19/06/2017
2	One day workshop on “Yoga For Health”	17/06/2017
3	3RD INTERNATIONAL YOGA DAY- 2017 on campus	21/06/2017
4	Marriage Trends And Challenges	29/07/2017
5	Swatch pakhwada	01/08/2017
6	Plantation in the college campus	3/08/2017
7	Three Day youth festival	9/9/2017 to 11/9/2017
8	Malaria Awareness	13/09/2017
9	NSS Pre RD camp	20/09/2017
10	Indian Association for the blind	25/09/2017
11	Blood Donation camp at police Commissionarate	17/10/17
12	Blood Donation camp At college campus	12/01/2018
13	Distribution of Dustbins	01/12/2017
14	National Youth day celebrations	10/1/2018
15	Swatch sarvekshan	20/01/2018
16	Viveka Subhashitam	23/01/2018
17	22nd National youth festival	03/2/2018
18	Enroll the young voters	12/2/18
19	Women’s day	8/3/2018
20	State employability skill training program	14/03/2018

Kanhu

PRINCIPAL
 MAHAVEER
 INSTITUTE OF SCIENCE & TECHNOLOGY
 Bandlaguda, Hyd-500 005.

Vysapuri, Bandlaguda Post:Keshavgi,
Hyderabad-500 005, TELANGANA INDIA
Tel: 040-64596979,8978380692,
Fax: 040-24455003
E-mail: principal.mahaveer@gmail.com,
Website: www.mist.ac.in,

MAHAVEER



Approved by AICTE, Affiliated to JNTUH,Hyd.

Date: 16/06/2017

CIRCULAR

Sub: Sponsoring tribal child education Be good- do good

All the faculty members and students are here by informed that "Sponsoring tribal child education" will be organised by NSS unit of Mahaveer Institute Of Science and Technology is scheduled on 19TH JUNE 2017 between 9.30AM to 2.00PM in our college campus. Students, teaching and non-teaching staff members are requested to participate this event.

Copy to:
All Hod's, Principal
polytechnic, Exam
Branch incharge,
Librarian

PRINCIPAL
MAHAVEER
INSTITUTE OF SCIENCE & TECHNOLOGY
Bandlaguda, Hyd-500 005.



PRINCIPAL

PRINCIPAL
MAHAVEER
INSTITUTE OF SCIENCE & TECHNOLOGY
Bandlaguda, Hyd-500 005.

Vysapuri, Bandlaguda Post:Keshavgi,
Hyderabad-500 005, TELANGANA INDIA
Tel: 040-64596979,8978380692,
Fax: 040-24455003
E-mail: principal.mahaveer@gmail.com
Website: www.mist.ac.in.

MAHAVEER
INSTITUTE OF SCIENCE & TECHNOLOGY
Approved by AICTE, Affiliated to JNTUH,Hyd.



Dt: 19/06/2017

Programme 1: Sponsoring tribal child education

Sponsoring Tribal Child Education as part of **BE GOOD DO GOOD** programme our college taken initiative to sponsoring tribal child education which is working in remotest tribal hamlets promoting education through single teacher school with association of friends of tribal society in the year 2018 we donated **Three Thousand Five Hundred And Ninety Nine Rupees** to this society, so we are thank ful to members, students and faculty who donated generously.

Collected amount was handed in form of cash to *Sri .Srinivas garu* founder of friends of Tribal society at **RK math** on the occasion of **Subhas Chandra Bose jayanthi** on 23-01-2017



Keshavgi

PRINCIPAL
MAHAVEER
INSTITUTE OF SCIENCE & TECHNOLOGY
Bandlaguda, Hyd-500 005.

Vysapuri, Bandlaguda Post:Keshavgi,
Hyderabad-500 005, TELANGANA INDIA
Tel: 040-64596979,8978380692,
Fax: 040-24455003
E-mail: principal.mahaveer@gmail.com
Website: www.mist.ac.in,

MAHAVEER

Approved by AICTE. Affiliated to JNTUH,Hyd.



Dt: 19/06/2017

Event Name:BE GOOD DO GOOD

ORGANIZING COMMITTEE

Student organizing members:

S NO	STUDENT NAME	BRANCH	YEAR
1	CHARAN	CIVIL	III
2	P SRI CHAITANYA	MECH	II
3	MANISH	ECE	III
4	SALMON CHOUDARY	CSE	IV
5	AKHILA	IT	II

Faculty organizing members:

S NO	NAME OF THE FACULTY	DESIGNATION	DEPT
1	Dr M Vasanthaxmi	ASSOCIATE PROFESSOR	CIVIL

Keshavgi
PRINCIPAL
MAHAVEER
INSTITUTE OF SCIENCE & TECHNOLOGY
Bandlaguda, Hyd-500 005.

Vysapuri, Bandlaguda Post:Keshavgiri,
Hyderabad-500 005, TELANGANA INDIA
Tel: 040-64596979,8978380692,
Fax: 040-24455003
E-mail: principal.mahaveer@gmail.com
Website: www.mist.ac.in,

MAHAVEER

Approved by AICTE, Affiliated to JNTUH,Hyd.



Dt: 19/06/2017

Event Name:BE GOOD DO GOOD

Student Participation List

S NO	STUDENT NAME	BRANCH	YEAR
1.	R VINAYAK GOVIND CHARY	DME	I
2.	M GANESH	DME	I
3.	M APARNA	CSE	I
4.	D PRANEETH	CIVIL	I
5.	HARIKA	CIVIL	I
6.	K AKSHAY SAGAR	ECE	I
7.	M SS VYBHAV	CSE	I
8.	P ROHITH	ECE	I
9.	A HARSHITH	EEE	I
10.	M RENUKA	ECE	I
11.	L SAMHITHA	IT	I
12.	TANISHKA GARLANDE	CSE	I
13.	R VANDANA	CSE	II
14.	P RETHIMA REDDY	CSE	III
15.	K SRUTHI	CSE	III
16.	KOUSHIK	ECE	III
17.	A LAVANYA	ECE	II
18.	BS NAGA JYOTHI	ECE	II
19.	A VENKATA KRISHNA VAMSHI	ECE	III
20.	J VAMSHI	CSE	II

Kishu

Principal
Mahaveer Institute of Science & Technology
Vysapuri, Bandlaguda Post, Keshavgiri,
Hyderabad - 500 005, Telangana, India

Vysapuri, Bandlaguda Post:Keshavgiri,
Hyderabad-500 005, TELANGANA INDIA
Tel: 040-64596979,8978380692,
Fax: 040-24455003
E-mail: principal.mahaveer@gmail.com,
Website: www.mist.ac.in,

MAHAVEER

Approved by AICTE, Affiliated to JNTUH,Hyd.



Date: 15/6/2017

CIRCULAR

Sub: ONE DAY WORKSHOP ON YOGA FOR HEALTH

All the faculty members and students are here by informed that "ONE DAY WORKSHOP ON YOGA FOR HEALTH" will be organised by NSS unit of Mahaveer Institute Of Science and Technology collaborating with SAMSKRUTHI FOUNDATION is scheduled on 17TH JUNE 2017 between 9.30AM to 4.00PM in JNTUH CAMPUS. Students, teaching and non-teaching staff members are requested to participate this event.

Copy to:
All Hod's, Principal
polytechnic, Exam
Branch incharge,
Librarian

PRINCIPAL

PRINCIPAL
MAHAVEER
INSTITUTE OF SCIENCE & TECHNOLOGY
Bandlaguda, Hyd-500 005.

PRINCIPAL
MAHAVEER
INSTITUTE OF SCIENCE & TECHNOLOGY
Bandlaguda, Hyd-500 005.

Vysapuri, Bandlaguda Post:Keshavgi,
Hyderabad-500 005, TELANGANA INDIA
Tel: 040-64596979,8978380692.
Fax: 040-24455003
E-mail: principal.mahaveer@gmail.com
Website: www.mist.ac.in.

MAHAVEER
INSTITUTE OF SCIENCE & TECHNOLOGY
Approved by AICTE, Affiliated to JNTUH,Hyd.



Dt: 17/06/2017

Programme 2 : One day workshop on “Yoga For Health”

JNTUH NSS cell is organizing one day workshop on *Yoga For Health* collaborating with *Samskruti Foundation* scheduled on 17th June 2017, in JNTUH campus. Attended by *DR M. Vasantha Laxmi Programme Officer* of NSS Unit Mahaveer Institute of science and Technology.

This programme is headed by *Dr.P.Sammulal NSS coordinator JNTUH*, Registrar Dr N.Yadaiah, Dr A. Govardhan (Head of the dept CSE) *W.G.Prasanna Kumar Chairmen National Council Of Rural Institutes(NCRI)* was given awareness and training on yoga and also provided some literature on yoga by *Samskruti Foundation*.



K. Srinivas
PRINCIPAL
MAHAVEER
INSTITUTE OF SCIENCE & TECHNOLOGY
Bandlaguda, Hyd-500 005.

Vysapuri, Bandlaguda Post:Keshavgiri,
Hyderabad-500 005, TELANGANA INDIA
Tel: 040-64596979,8978380692,
Fax: 040-24455003
E-mail: principal.mahaveer@gmail.com
Website: www.mist.ac.in,

MAHAVEER

Approved by AICTE, Affiliated to JNTUH,Hyd.



Dt: 17/06/2017

EVENT NAME:ONE DAY WORKSHOP ON “YOGA FOR HEALTH”

Student Participation List

S NO	STUDENT NAME	BRANCH	YEAR
1.	BHUKYA RAVINDER	ECE	II
2.	HASBI SHRUTHI	ECE	II
3.	CHILUKA HARISH	ECE	II
4.	K VEERESH	EEE	II
5.	MANGILPELLY SAI KUMAR	CSE	II
6.	RIKKA VANDANA	CSE	II
7.	JAKKULA VAMSHI	CSE	II
8.	J NIKITHA	CSE	II
9.	R KARTHIK KUMAR	IT	II
10.	S.MAHENDER REDDY	CSE	III
11.	SAI TEJA	ECE	III
12.	VISHNU	CSE	IV
13.	G.RAJESH	CSE	III
14.	K.VISHNU	ECE	III

Kshy
PRINCIPAL
MAHAVEER
INSTITUTE OF SCIENCE & TECHNOLOGY
Bandlaguda, Hyd-500 005.

Vysapuri, Bandlaguda Post:Keshavgiri,
Hyderabad-500 005, TELANGANA INDIA
Tel: 040-64596979,8978380692,
Fax: 040-24455003
E-mail: principal.mahaveer@gmail.com,
Website: www.mist.ac.in,

MAHAVEER

Approved by AICTE, Affiliated to JNTUH,Hyd.



Date: 19/06/2017

CIRCULAR

Sub: 3rd International yoga day at campus

All the faculty members and students are here by informed that "3rd International yoga day at campus" will be organised by NSS unit of Mahaveer Institute Of Science and Technology in Association with isha yoga center is scheduled on **21th JUNE 2017** between 9.30AM to 2.00PM in our college campus. Students, teaching and non-teaching staff members are requested to participate this event.

Copy to:
All Hod's, Principal
polytechnic, Exam
Branch incharge,
Librarian

PRINCIPAL
MAHAVEER
INSTITUTE OF SCIENCE & TECHNOLOGY
Bandlaguda, Hyd-500 005.

PRINCIPAL

PRINCIPAL
MAHAVEER
INSTITUTE OF SCIENCE & TECHNOLOGY
Bandlaguda, Hyd-500 005.

Vysapuri, Bandlaguda Post:Keshavgiri,
Hyderabad-500 005, TELANGANA INDIA
Tel: 040-64596979,8978380692,
Fax: 040-24455003
E-mail: principal.mahaveer@gmail.com
Website: www.mist.ac.in.

MAHAVEER

Approved by AICTE, Affiliated to JNTUH,Hyd.



Dt: 21/06/2017

Programme 3 : 3RD INTERNATIONAL YOGA DAY-2017 on campus

3rd International yoga Day was celebrated by *Mahaveer Group Of Institutions On 21 June 2017*. The programme was organized in Tournament Hall of AAR Mahaveer Engineering college. It started at 11.00 AM with Vandematharam song and lighting of the lamp. *Sri.S.Sudharshn Reddy Chairman* of Mahaveer group of Institutions, *Sri.S.Surender Reddy, Secretary* Mahaveer group of Institutions, *Sri Ravi Kumar And Ms.Bitapi, Volunteers From ISHA Foundation, Principal*, Heads of the departments, teaching and non-teaching members of the institutes and students participated in the programme.

Next, Mr. Ravi Kumar, Volunteer, ISHA foundation started the yoga session by showing Audio Visual module. They showed various *Upa-Yoga practices* and made the participants to practice the same in the hall. It was a 90 minutes session. Upa-Yoga helps to overcome physical as well as psychological stress. Upa-Yoga asanas which were taught help us to improve health, for success, to create Joy, Peace and Love in life. The module says that these practices can be followed by anyone above 7 years of age.

Sri.S.Sudharshn Reddy ,Chairman of Mahaveer group of Institutions spoke on this occasion. He stressed upon the introduction of Yoga practicing in present education system. This will help the students to overcome various problems and improves concentration enabling to succeed in their life. The practices which were in use earlier days should not be avoided and he requested everyone to keep practicing such healthy activities in this stressful environment. He said Mahaveer Group of Institutions will always encourage and promote such healthy programmes.

PRINCIPAL
MAHAVEER GROUP OF INSTITUTIONS
BANDLAGUDA, HYD-500 005

Vysapuri, Bandlaguda Post:Keshavgiri,
Hyderabad-500 005, TELANGANA INDIA
Tel: 040-64596979,8978380692.
Fax: 040-24455003
E-mail: principal.mahaveer@gmail.com
Website: www.mist.ac.in.

MAHAVEER
INSTITUTE OF SCIENCE & TECHNOLOGY
Approved by AICTE, Affiliated to JNTUH,Hyd.



3RD INTERNATIONAL YOGA DAY-2017

At LB Stadium

With reference to your letter dated 17, June, 2017 (*Lr.No. JNTUH/NSS International Yoga day programmeme /2016-17*) and In accordance with state NSS office request, Our college Programmeme Officer *Dr .M.Vasantha Laxmi And Twenty NSS Volunteers* have participated in International Yoga day programmeme, and the Meditation programmeme conducted at L B Stadium, Hyderabad on *21st June between 5.00 to 7.00PM* as per the instructions from the Ministry of Youth affairs & Sports, Govt. of India



K. Srinivas
PRINCIPAL
MAHAVEER
INSTITUTE OF SCIENCE & TECHNOLOGY
HYD-500 005.

Vysapuri, Bandlaguda Post:Keshavgiri,
Hyderabad-500 005, TELANGANA INDIA
Tel: 040-64596979,8978380692,
Fax: 040-24455003
E-mail: principal.mahaveer@gmail.com
Website: www.mist.ac.in.

MAHAVEER
INSTITUTE OF SCIENCE & TECHNOLOGY
Approved by AICTE, Affiliated to JNTUH,Hyd.



Keshvi
PRINCIPAL
MAHAVEER
INSTITUTE OF SCIENCE & TECHNOLOGY
Bandlaguda, Hyd-500 005.

Vysapuri, Bandlaguda Post:Keshavgi,
Hyderabad-500 005, TELANGANA INDIA
Tel: 040-64596979,8978380692,
Fax: 040-24455003
E-mail: principal.mahaveer@gmail.com
Website: www.mist.ac.in.

MAHAVEER
INSTITUTE OF SCIENCE & TECHNOLOGY
Approved by AICTE, Affiliated to JNTUH,Hyd.



Isha foundation provided Yoga modules CDs to the participants so that they can practice at home. The Management of Mahaveer group of Institutions felicitated the Isha Volunteers. After the programme, fruits were provided to the participants. Around 300 members took part in this programme. The programme concludes at 1.00 p.m.



Kishor
PRINCIPAL
MAHAVEER
INSTITUTE OF SCIENCE & TECHNOLOGY
Bandlaguda, Hyd-500 005.

Vysapuri, Bandlaguda Post:Keshavgi,
Hyderabad-500 005, TELANGANA INDIA
Tel: 040-64596979,8978380692,
Fax: 040-24455003
E-mail: principal.mahaveer@gmail.com
Website: www.mist.ac.in.

MAHAVEER
INSTITUTE OF SCIENCE & TECHNOLOGY
Approved by AICTE, Affiliated to JNTUH,Hyd.



1.S.Mahender Reddy -15E31A0555
2.P.Reethima Reddy -15E31A0547
3.N.Chaitanya -15E31A0518
4.N.Vinay-15E31A0542
5.BHS Lahari-15E31A0510
6.G.Rajesh--15E31A0523.
7.K.Sruteja-15E31A0526
8.G.Ashok-15E31A0539
9.G.Sankeerth-15E31A0521
10.Sai teja-15E31A0403

11.M.Jaipal-15E31A0406
12.K.Vishnu-15E31A0411
13.Pavan kumar-14E31A0120
14.Manoj-16E31A0541
15.Seshank-16E31A0509
16.Varun-16E31A0470
17.Khushbhu Dongare-14E31A0526
18.Nishanth-14E31A0522
19.Vishnu-14E31A0501
20.D.Purna chander-15E31 A2108



Kanthy
PRINCIPAL
MAHAVEER
INSTITUTE OF SCIENCE & TECHNOLOGY
Bandlaguda, Hyd-500 005.

Vysapuri, Bandlaguda Post:Keshavgi,
Hyderabad-500 005, TELANGANA INDIA
Tel: 040-64596979,8978380692,
Fax: 040-24455003
E-mail: principal.mahaveer@gmail.com
Website: www.mist.ac.in,

MAHAVEER

Approved by AICTE, Affiliated to JNTUH,Hyd.



Dt:21-06-2017

EVENT NAME:3RD INTERNATIONAL YOGA DAY-2017 AT LB STADIUM

ORGANIZING COMMITTEE

Student organizing members:

S NO	STUDENT NAME	BRANCH	YEAR
1	KHUSHBHU DONGARE	CSE	IV
2	NISHANTH	CSE	IV
3	VISHNU	CSE	IV
4	PAVAN KUMAR	CIVIL	IV

Faculty organizing members:

S NO	NAME OF THE FACULTY	DESIGNATION	DEPT
1	Dr M Vasanthaxmi	ASSOCIATE PROFESSOR	CIVIL

PRINCIPAL
MAHAVEER
INSTITUTE OF SCIENCE & TECHNOLOGY
Bandlaguda, Hyd-500 005.

Vysapuri, Bandlaguda Post:Keshavgi,
Hyderabad-500 005, TELANGANA INDIA
Tel: 040-64596979,8978380692.
Fax: 040-24455003
E-mail: principal.mahaveer@gmail.com
Website: www.mist.ac.in,

MAHAVEER



Approved by AICTE, Affiliated to JNTUH,Hyd.

Dt: 21/06/2017

EVENT NAME:3RD INTERNATIONAL YOGA DAY-2017 AT LB STADIUM

Student Participation List

S NO	STUDENT NAME	BRANCH	YEAR
1.	S MAHENDER REDDY	CSE	III
2.	P.REETHIMA REDDY	CSE	III
3.	N.CHAITANYA	CSE	III
4.	N.VINAY	CSE	III
5.	BHS LAHARI	CSE	III
6.	G.RAJESH	CSE	III
7.	K.SRUTEJA	CSE	III
8.	G.ASHOK	CSE	III
9.	G.SANKEERTH	CSE	III
10.	SAJ TEJA	ECE	III
11.	M.JAIPAL	ECE	III
12.	K.VISHNU	ECE	III
13.	PAVAN KUMAR	CIVIL	IV
14.	MANOJ	CSE	II
15.	SESHANK	CSE	II
16.	VARUN	ECE	II
17.	KHUSHBHU DONGARE	CSE	IV
18.	NISHANTH	CSE	IV
19.	VISHNU	CSE	IV
20.	D.PURNA CHANDER	AERO	III

Kishu
PRINCIPAL
MAHAVEER
INSTITUTE OF SCIENCE & TECHNOLOGY
HYD

Vysapuri, Bandlaguda Post:Keshavgi,
Hyderabad-500 005, TELANGANA INDIA
Tel: 040-64596979,8978380692,
Fax: 040-24455003
E-mail: principal.mahaveer@gmail.com,
Website: www.mist.ac.in,

MAHAVEER

Approved by AICTE, Affiliated to JNTUH,Hyd.



Date: 27/07/2017

CIRCULAR

Sub: Marriage Trends And Challenges

All the faculty members and students are here by informed that "Marriage Trends And Challenges" will be organised by NSS unit of Mahaveer Institute Of Science and Technology in Association with ngos teenage temptations is scheduled on 29TH JULY 2017 between 9.30AM to 2.00PM in JNTUH kukatpally. Students, teaching and non-teaching staff members are requested to participate this event.

PRINCIPAL
MAHAVEER
INSTITUTE OF SCIENCE & TECHNOLOGY
Bandlaguda, Hyd-500 005.

PRINCIPAL

PRINCIPAL
MAHAVEER
INSTITUTE OF SCIENCE & TECHNOLOGY
Bandlaguda, Hyd-500 005.

Copy to:

All Hod's, Principal
polytechnic, Exam
Branch incharge,
Librarian

Vysapuri, Bandlaguda Post:Keshavgi,
Hyderabad-500 005, TELANGANA INDIA
Tel: 040-64596979,8978380692.
Fax: 040-24455003
E-mail: principal.mahaveer@gmail.com
Website: www.mist.ac.in.

MAHAVEER
INSTITUTE OF SCIENCE & TECHNOLOGY
Approved by AICTE, Affiliated to JNTUH,Hyd.



Dt: 29/07/2017

Programme 4 : Marriage Trends And Challenges

"National Seminar on Marriage trends and challenges", organized by *NGOS Teenage Temptations, you and me, SPHOORTHY*, Cyberabad police, Telangana State police scheduled on 29th JULY 2017 at 10:00am in *JN Auditorium JNTUH*, Kukatpally, Hyderabad

Students of III year CSE along with one faculty **K.Giribabu Asst. prof** , dept of CSE were participated in the one day National seminar

The chief guest for inauguration honorable minister of telangana **Sri Nayini Narasimha Reddy garu** and **prof.M Sridhar Acharyulu Garu** central investigation commissioner.



Kishu
PRINCIPAL
MAHAVEER

Vysapuri, Bandlaguda Post:Keshavgi,
Hyderabad-500 005, TELANGANA INDIA
Tel: 040-64596979,8978380692,
Fax: 040-24455003
E-mail: principal.mahaveer@gmail.com
Website: www.mist.ac.in,

MAHAVEER

Approved by AICTE, Affiliated to JNTUH,Hyd.



Dt: 29/07/2017

EVENT NAME:MARRIAGE TRENDS AND CHALLENGES

Student Participation List

S NO	STUDENT NAME	BRANCH	YEAR
1.	S MAHENDER REDDY	CSE	III
2.	P.REETHIMA REDDY	CSE	III
3.	N.CHAITANYA	CSE	III
4.	N.VINAY	CSE	III
5.	BHS LAHARI	CSE	III
6.	G.RAJESH	CSE	III
7.	K.SRUTEJA	CSE	III
8.	G.ASHOK	CSE	III
9.	G.SANKEERTH	CSE	III
10.	SAI TEJA	ECE	III
11.	M.JAIPAL	ECE	III
12.	K.VISHNU	ECE	III

Keshavgi
PRINCIPAL
MAHAVEER
INSTITUTE OF SCIENCE & TECHNOLOGY
Bandlaguda, Hyd-500 005.

Vysapuri, Bandlaguda Post:Keshavgiri,
Hyderabad-500 005, TELANGANA INDIA
Tel: 040-64596979,8978380692,
Fax: 040-24455003
E-mail: principal.mahaveer@gmail.com,
Website: www.mist.ac.in,

MAHAVEER

Approved by AICTE. Affiliated to JNTUH.Hyd.



Date: 31/07/2017

CIRCULAR

Sub: Swatch pakhwada

All the faculty members and students are here by informed that “Swatch pakhwada” will be organised by NSS unit of Mahaveer Institute Of Science and Technology in Association with ministry of youth affairs and sports is scheduled on **01ST AUGUST 2017** between 9.30AM to 2.00PM in our college campus. Students, teaching and non-teaching staff members are requested to participate this event.

Copy to:

All Hod's, Principal
polytechnic, Exam
Branch incharge,
Librarian

PRINCIPAL
MAHAVEER
INSTITUTE OF SCIENCE & TECHNOLOGY
Bandlaguda, Hyd-500 005.

PRINCIPAL

PRINCIPAL
MAHAVEER
INSTITUTE OF SCIENCE & TECHNOLOGY
Bandlaguda, Hyd-500 005.

Vysapuri, Bandlaguda Post:Keshavgi,
Hyderabad-500 005, TELANGANA INDIA
Tel: 040-64596979,8978380692,
Fax: 040-24455003
E-mail: principal.mahaveer@gmail.com
Website: www.mist.ac.in.

MAHAVEER
INSTITUTE OF SCIENCE & TECHNOLOGY
Approved by AICTE, Affiliated to JNTUH,Hyd.



Dt: 01/08/2017

Programme 5 : Swatch pakhwada

As part of NSS Action plan 2017-18 circulated by the respective state NSS Officers it is to state that as per the directions of the *Ministry Of Youth Affairs & Sports*, Govt of India, all the NSS units in the state must observe "*Swatch Pakhwada*" from 1/08/2017 to 15/08/2017.

Hence, Swatch pakhwada is insisted in the college campus, students were participated in this regard and they decorated their class rooms , and prizes were also distributed for the best classrooms . Every day *Swatchtha pledge* is organized in all class rooms at 9.30am.



Keshavgi
PRINCIPAL
MAHAVEER

Vysapuri, Bandlaguda Post:Keshavgiri,
Hyderabad-500 005, TELANGANA INDIA
Tel: 040-64596979,8978380692,
Fax: 040-24455003
E-mail: principal.mahaveer@gmail.com
Website: www.mist.ac.in,

MAHAVEER

Approved by AICTE, Affiliated to JNTUH,Hyd.



Dt: 01/08/2017

EVENT NAME:SWATCH PAKHWADA

ORGANIZING COMMITTEE

Student organizing members:

S NO	STUDENT NAME	BRANCH	YEAR
1	N.CHAITANYA	CSE	III
2	NISHANTH	CSE	IV
3	SAI TEJA	ECE	III
4	PAVAN KUMAR	CIVIL	IV
5	G.RAJESH	CSE	III
6	K.SRUTEJA	CSE	III

Faculty organizing members:

S NO	NAME OF THE FACULTY	DESIGNATION	DEPT
1	Dr M Vasanthaxmi	ASSOCIATE PROFERSOR	CIVIL

Keshu
PRINCIPAL
MAHAVEER
INSTITUTE OF SCIENCE & TECHNOLOGY
Bandlaguda, Hyd-500 005

Vysapuri, Bandlaguda Post:Keshavgiri,
Hyderabad-500 005, TELANGANA INDIA
Tel: 040-64596979,8978380692,
Fax: 040-24455003
E-mail: principal.mahaveer@gmail.com,
Website: www.mist.ac.in,

MAHAVEER

Approved by AICTE, Affiliated to JNTUH.Hyd.



Date: 01/8/2017

CIRCULAR

Sub: Plantation in the college campus

All the faculty members and students are here by informed that "Plantation in the college campus" will be organised by NSS unit of Mahaveer Institute Of Science and Technology is scheduled on 3RD AUGUST 2017 between 9.30AM to 2.00PM in our college campus. Students, teaching and non-teaching staff members are requested to participate this event.

Copy to:

All Hod's, Principal
polytechnic, Exam
Branch incharge,
Librarian

PRINCIPAL
MAHAVEER
INSTITUTE OF SCIENCE & TECHNOLOGY
Bandlaguda, Hyd-500 005.

PRINCIPAL
PRINCIPAL
MAHAVEER
INSTITUTE OF SCIENCE & TECHNOLOGY
Bandlaguda, Hyd-500 005.

Vysapuri, Bandlaguda Post:Keshavgi,
Hyderabad-500 005, TELANGANA INDIA
Tel: 040-64596979,8978380692.
Fax: 040-24455003
E-mail: principal.mahaveer@gmail.com
Website: www.mist.ac.in.

MAHAVEER
INSTITUTE OF SCIENCE & TECHNOLOGY
Approved by AICTE, Affiliated to JNTUH,Hyd.



Dt: 3/08/2017

Programmeme 6: Plantation in the college campus

Plantation program was conducted by ECE A & B students in the college campus as part of *Haritha Haram* and Environmental studies as a circular part of their syllabus they bought ornamental plants to increase the aestheticness of campus and they inspired other branches students and they were appreciated by management and faculty for their contribution towards green campus.



Kshanti
PRINCIPAL
MAHAVEER
INSTITUTE OF SCIENCE & TECHNOLOGY

Vysapuri, Bandlaguda Post:Keshavgi,
Hyderabad-500 005, TELANGANA INDIA
Tel: 040-64596979,8978380692,
Fax: 040-24455003
E-mail: principal.mahaveer@gmail.com,
Website: www.mist.ac.in,

MAHAVEER



Approved by AICTE, Affiliated to JNTUH.Hyd.

Date: 7/9/2017

CIRCULAR

Sub: Three Days youth festival

All the faculty members and students are here by informed that **"Three Days youth festival"** will be organised by NSS unit of Mahaveer Institute Of Science and Technology in Association with viveka nanda institute of human excellence is scheduled on **09TH SEPTEMBER 2017 -11TH SEPTEMBER 2017** between 9.30AM to 2.00PM at viveka nanda institute of human excellence . Students, teaching and non-teaching staff members are requested to participate this event.

Copy to:

All Hod's, Principal
polytechnic, Exam
Branch incharge,
Librarian

PRINCIPAL
MAHAVEER
INSTITUTE OF SCIENCE & TECHNOLOGY
Bandlaguda, Hyd-500 005.

PRINCIPAL

PRINCIPAL
MAHAVEER
INSTITUTE OF SCIENCE & TECHNOLOGY
Bandlaguda, Hyd-500 005.

Vysapuri, Bandlaguda Post:Keshavgiri,
Hyderabad-500 005, TELANGANA INDIA
Tel: 040-64596979,8978380692,
Fax: 040-24455003
E-mail: principal.mahaveer@gmail.com
Website: www.mist.ac.in,

MAHAVEER

Approved by AICTE, Affiliated to JNTUH,Hyd.



Dt: 03/08/2017

EVENT NAME:Plantation in the college campus

ORGANIZING COMMITTEE

Student organizing members:

S NO	STUDENT NAME	BRANCH	YEAR
1	AKULA SHUCHENDRA	ECE	II
2	ALLE VINAY KUMAR	ECE	II
3	BIRUDU HARINI	ECE	II
4	GOVIND SOWMYA	ECE	II
5	DHARAVATH SHIVAKUMAR	ECE	II
6	GILLALA PRANEETH REDDY	ECE	II

Faculty organizing members:

S NO	NAME OF THE FACULTY	DESIGNATION	DEPT
1	Dr M VASANTHA LAKSHMI	ASSOCIATE PROFESSOR	CIVIL

PRINCIPAL
MAHAVEER
INSTITUTE OF SCIENCE & TECHNOLOGY
Bandlaguda, Hyd-500 005.

Vysapuri, Bandlaguda Post:Keshavgi,
Hyderabad-500 005, TELANGANA INDIA
Tel: 040-64596979,8978380692,
Fax: 040-24455003
E-mail: principal.mahaveer@gmail.com
Website: www.mist.ac.in.

MAHAVEER

Approved by AICTE, Affiliated to JNTUH,Hyd



Dt: 9/9/2017 to 11/9/2017

Programme 7: Three Day youth festival

Programme was conducted by *Vivekananda Institute Of Human Excellence As Part Of 18th Foundation Day Celebrations* on 9/9/2017 Convention Theme was "*Leadership Excellence*" Speakers of the day was Sri V. Lakshminarayan IPS , Sri Sharad Sagar Founder and CEO Of Dexterity Global is an Indian Youth Icon Sri Vijay Menon was faculty of IIMS at trainer of IAS officers.

Second Theme was *Education For The Future* Introduction of the theme by *Swami bhodhamayananda* and followed by Sri V. Laxminarayan IPS , Sri Sharath Sagar , Sri Vijay Menon and prof J Mahender Reddy Vice Chancellor ICFAI Univercity Hyderabad third Theme Was Universal Brotherhood Day youth Convention chief Guest for that day was M.G.Sekharam, IRTS Chief commercial manager south central railway secunderabad

Alomost 100 students along with faculty coordinators of different branches from Mahaveer college were participated in this programme and every student was enlightened by the greate people and very much impressed by the speech of Sharath vivek sagar

PRINCIPAL
MAHAVEER
INSTITUTE OF SCIENCE & TECHNOLOGY
Bandlaguda, Hyd-500 005

Vysapuri, Bandlaguda Post:Keshavgi,
Hyderabad-500 005, TELANGANA INDIA
Tel: 040-64596979,8978380692,
Fax: 040-24455003
E-mail: principal.mahaveer@gmail.com
Website: www.mist.ac.in.

MAHAVEER
INSTITUTE OF SCIENCE & TECHNOLOGY
Approved by AICTE, Affiliated to JNTUH,Hyd.



Kishu
PRINCIPAL
MAHAVEER
INSTITUTE OF SCIENCE & TECHNOLOGY
Bandlaguda, Hyd-500 005.

Vysapuri, Bandlaguda Post:Keshavgi,
Hyderabad-500 005, TELANGANA INDIA
Tel: 040-64596979,8978380692,
Fax: 040-24455003
E-mail: principal.mahaveer@gmail.com
Website: www.mist.ac.in,

MAHAVEER

Approved by AICTE. Affiliated to JNTUH,Hyd



Dt: 20/09/2017

EVENT NAME:NSS PRE RD CAMP

ORGANIZING COMMITTEE

Student organizing members:

S NO	STUDENT NAME	BRANCH	YEAR
1	ADUNUTULA VISHNU PREETH REDDY	CSE	IV
2	AENUGU RASAGNYA	CSE	IV
3	GAJJALA DHRUVA MANASA	CSE	IV
4	GUMMALLA SAI NISHANTH REDDY	CSE	IV
5	GILLA RAJESH	CSE	IV
6	BODDU VAIBHAV	ECE	IV
7	KAMSANI NAVEENKUMAR	ECE	IV
8	PORALLA BHARATH KUMAR	ECE	IV
9	N HARI PRASAD	ECE	IV

Faculty organizing members:

S NO	NAME OF THE FACULTY	DESIGNATION	DEPT
1	Dr M VASANTHA LAKSHMI	ASSOCIATE PROFESSOR	CIVIL

PRINCIPAL
MAHAVEER
INSTITUTE OF SCIENCE & TECHNOLOGY
Bandlaguda, Hyd-500 005.

Vysapuri, Bandlaguda Post:Keshavgiri,
Hyderabad-500 005, TELANGANA INDIA
Tel: 040-64596979,8978380692,
Fax: 040-24455003
E-mail: principal.mahaveer@gmail.com
Website: www.mist.ac.in,

MAHAVEER

Approved by AICTE, Affiliated to JNTUH,Hyd.



Dt: 20/09/2017

EVENT NAME:NSS PRE RD CAMP

Student Participation List

S NO	STUDENT NAME	BRANCH	YEAR
1	SHIRISHA YADAV	EEE	III
2	SAI KIRAN REDDY	EEE	III
3	ABHISHEK	EEE	III
4	SHANKAR	EEE	III
5	A RASAGNYA	CSE	IV
6	E ANUPRIYA	CSE	IV
7	G DHRUVA MANASA	CSE	IV
8	N AKHILENDRA	CSE	IV
9	A PAVAN	IT	II
10	A BALAKRISHNA GOUD	ECE	III
11	A VENKATA KRISHNA VAMSHI	ECE	IV
12	P SRIKANTH	ECE	III
13	RAGHAVENDRA	ECE	III
14	AMAR HUSSAIN	ECE	III
15	SAIRAM	ECE	III
16	A VINAY	ECE	III
17	KIRAN G	ECE	III
18	D SAI TEJA	ECE	III
19	B VASU	ECE	III
20	B SAI VARMA	ECE	IV
21	G SAI TEJA	ECE	IV
22	M SHIVARAM	ECE	IV
23	G SURESH	EEE	IV
24	M JAIPAL	ECE	IV
25	SHAIK MOHAMMED RAYAN	MECH	IV
26	SHAIK SOHAIL	MECH	IV
27	MOHAMMED KHAN	MECH	IV
28	SYED MUZAMI	MECH	IV
29	MOHAMMED AJAZ KHAN	MECH	IV
30	B KISHORE	MECH	IV
31	P KRISHNA	MECH	IV
32	N AKASH	MECH	IV
33	J VAMSHI KRISHIA	MECH	IV
34	K SUSHMITHA	MECH	IV
35	A PUSHIPANJALI	MECH	IV
36	M SHIVA PRAGATHI	MECH	IV

PRINCIPAL

MAHAVEER

INSTITUTE OF SCIENCE & TECHNOLOGY
Bandlaguda, Hyd-500 005.

Vysapuri, Bandlaguda Post:Keshavgi,
Hyderabad-500 005, TELANGANA INDIA
Tel: 040-64596979,8978380692,
Fax: 040-24455003
E-mail: principal.mahaveer@gmail.com
Website: www.mist.ac.in.

MAHAVEER

Approved by AICTE, Affiliated to JNTUH,Hyd.



Dt: 20/09/2017

Programme 9 : NSS Pre RD camp

This programme was conducted for *Selection Of Volunteers For NSS PRE-RD camp* on 18/9/2017 almost *45 students* were enthusiastic and attended college level screening tests , i.e written test, followed by *1.5km running, march fast constantly for 20mnts*

Selected students were Suraj kumar from ECE III yr(15E31A0497), P.shirisha Yadav from EEE III year (16E35A0206) ,k.saikiran Reddy from EEE III yr(15E31A0216), N.Abhishek from EEE III yr(15E31A0225) and M.Sandeep from CIVIL IV yr(14E31A0125) further rounds from these rounds 1male and 1 Female students were sent to JNTUH along with the proper application and medical fitness certificate and security clearance certificate from police department.

Keshavgi
PRINCIPAL
MAHAVEER
INSTITUTE OF SCIENCE & TECHNOLOGY
Bandlaguda, Hyd-500 005.

Vysapuri, Bandlaguda Post:Keshavgiri,
Hyderabad-500 005, TELANGANA INDIA
Tel: 040-64596979,8978380692,
Fax: 040-24455003
E-mail: principal.mahaveer@gmail.com,
Website: www.misl.ac.in,

MAHAVEER



Approved by AICTE, Affiliated to JNTUH,Hyd.

Date: 18/09/2017

CIRCULAR

Sub: NSS PRE RD CAMP

All the faculty members and students are here by informed that "NSS PRE RD CAMP" will be organised by NSS unit of Mahaveer Institute Of Science and Technology is scheduled on 20TH SEPTEMBER 2017 between 9.30AM to 2.00PM in our college campus. Students, teaching and non-teaching staff members are requested to participate this event.

Copy to:

All Hod's, Principal
polytechnic, Exam
Branch incharge,
Librarian

PRINCIPAL

PRINCIPAL
MAHAVEER
INSTITUTE OF SCIENCE & TECHNOLOGY
Bandlaguda, Hyd-500 005.

PRINCIPAL
MAHAVEER
INSTITUTE OF SCIENCE & TECHNOLOGY
Bandlaguda, Hyd-500 005.

Vysapuri, Bandlaguda Post:Keshavgiri,
Hyderabad-500 005, TELANGANA INDIA
Tel: 040-64596979,8978380692,
Fax: 040-24455003
E-mail: principal.mahaveer@gmail.com
Website: www.mist.ac.in,

MAHAVEER

Approved by AICTE, Affiliated to JNTUH,Hyd.



Dt: 13/09/2017

EVENT NAME:MALARIA AWARENESS

ORGANIZING COMMITTEE

Student organizing members:

S NO	STUDENT NAME	BRANCH	YEAR
1	K.VISHNU	ECE	III
2	D SAITEJA	ECE	III
3	G.SANKEERTH	CSE	III
4	BHS LAHARI	CSE	III

Faculty organizing members:

S NO	NAME OF THE FACULTY	DESIGNATION	DEPT
1	Dr K KIRAN KUMAR	HOD, PROFESSOR	MBA

K. Kiran
PRINCIPAL
MAHAVEER
INSTITUTE OF SCIENCE & TECHNOLOGY
Bandlaguda, Hyd 500 005.

Vysapuri, Bandlaguda Post:Keshavgiri,
Hyderabad-500 005, TELANGANA INDIA
Tel: 040-64596979,8978380692,
Fax: 040-24455003
E-mail: principal.mahaveer@gmail.com
Website: www.mist.ac.in,

MAHAVEER

Approved by AICTE, Affiliated to JNTUH,Hyd.



Dt: 13/09/2017

EVENT NAME: MALARIA AWARENESS

Student Participation List

S NO	STUDENT NAME	BRANCH	YEAR
1	B SOHAN LAL	CIVIL	I
2	D SMARANI	CIVIL	I
3	L RAVI	EEE	I
4	B YASHWANTH	EEE	I
5	MD ARMAN	MECH	I
6	AYAY KUMAR	ECE	I
7	CH SAI KRISHNA	ECE	I
8	C AKHILA	ECE	I
9	K MEGHANA	ECE	I
10	B VARUN KUMAR	CSE	I
11	G SHREYA	CSE	I
12	M ADITYA BHARATH	CSE	I
13	P ANAND REDDY	CSE	I
14	B TRIVENI	CSE	I
15	B SOMESHWAR REDDY	CSE	I
16	C SRI LAKSHMI	CSE	I
17	N SRINIVAS	CSE	I
18	P LOKESH	CSE	I
19	S SIATEJA	CSE	I
20	K VINEETHA	IT	I
21	A SAI JAHAVI	IT	I
22	L SAMHITHA	IT	I
23	P SAI KIRAN	IT	I
24	A SPANDANA	AERO	I
25	V NARENDER	AERO	I
26	G VAISHNAVI	AERO	I

PRINCIPAL
MAHAVEER
INSTITUTE OF SCIENCE & TECHNOLOGY
Bandlaguda, Hyd-500 005.



Vysapuri, Bandlaguda Post:Keshavgiri,
Hyderabad-500 005, TELANGANA INDIA
Tel: 040-64596979,8978380692,
Fax: 040-24455003
E-mail: principal.mahaveer@gmail.com
Website: www.mist.ac.in.

MAHAVEER

Approved by AICTE, Affiliated to JNTUH,Hyd.



Dt: 13/09/2017

Programme 8: Malaria Awareness

"Malaria Awareness Programmeme" is organised by *NSS Unit Of Mahaveer Institute Of Science And Technology In Association With GHMC*, Chandrayangutta circle Charminar Zone is scheduled on 13th SEPTEMBER 2017 in our college campus.

After end of this programme Students were aware about malaria prevention , prevention of masquito breeding, masquito bites, entry of masquitos and treatment of malaria .

PRINCIPAL
MAHAVEER
INSTITUTE OF SCIENCE & TECHNOLOGY
Bandlaguda, Hyd-500 005.

Vysapuri, Bandlaguda Post:Keshavgi,
Hyderabad-500 005, TELANGANA INDIA
Tel: 040-64596979,8978380692,
Fax: 040-24455003
E-mail: principal.mahaveer@gmail.com,
Website: www.mist.ac.in,

MAHAVEER



Approved by AICTE, Affiliated to JNTUH,Hyd.

Date:11/09/2017

CIRCULAR

Sub: Malaria Awareness

All the faculty members and students are here by informed that "Malaria Awareness" will be organised by NSS unit of Mahaveer Institute Of Science and Technology in Association GHMC at chandrayan gutta charminar zone is scheduled on 13TH SEPTEMBER 2017 between 9.30AM to 2.00PM in our college campus. Students, teaching and non-teaching staff members are requested to participate this event.

PRINCIPAL

Copy to:

All Hod's, Principal
polytechnic, Exam
Branch incharge,
Librarian

PRINCIPAL
MAHAVEER
INSTITUTE OF SCIENCE & TECHNOLOGY
Bandlaguda, Hyd-500 005.

PRINCIPAL
MAHAVEER
INSTITUTE OF SCIENCE & TECHNOLOGY
Bandlaguda, Hyd-500 005.

Vysapuri, Bandlaguda Post:Keshavgirl,
Hyderabad-500 005, TELANGANA INDIA
Tel: 040-64596979,8978380692,
Fax: 040-24455003
E-mail: principal.mahaveer@gmail.com
Website: www.mist.ac.in,

MAHAVEER

Approved by AICTE, Affiliated to JNTUH,Hyd.



Dt: 9/09/2017 – 11/9/2017

EVENT NAME:THREE DAY YOUTH FESTIVAL

ORGANIZING COMMITTEE

Student organizing members:

S NO	STUDENT NAME	BRANCH	YEAR
1	N.CHAITANYA	CSE	III
2	S MAHENDER REDDY	CSE	III
3	D SAITEJA	ECE	III

Faculty organizing members:

S NO	NAME OF THE FACULTY	DESIGNATION	DEPT
1	Dr M Vasanthaxmi	ASSOCIATE PROFERSSOR	CIVIL

PRINCIPAL
MAHAVEER
INSTITUTE OF SCIENCE & TECHNOLOGY
Bandlaguda, Hyderabad-500 005.

Vysapuri, Bandlaguda Post:Keshavgiri,
Hyderabad-500 005, TELANGANA INDIA
Tel: 040-64596979,8978380692,
Fax: 040-24455003
E-mail: principal.mahaveer@gmail.com
Website: www.mist.ac.in,

MAHAVEER

Approved by AICTE, Affiliated to JNTUH,Hyd



Dt: 9/09/2017 – 11/9/2017

EVENT NAME:THREE DAY YOUTH FESTIVAL

Student Participation List

S NO	STUDENT NAME	BRANCH	YEAR
1	K MANEESHA	CSE	III
2	K SRUTHI	CSE	III
3	S MAHENDER REDDY	CSE	III
4	P.REETHIMA REDDY	CSE	III
5	N.CHAITANYA	CSE	III
6	N.VINAY	CSE	III
7	BHS LAHARI	CSE	III
8	G.RAJESH	CSE	III
9	K.SRUTEJA	CSE	III
10	G.ASHOK	CSE	III
11	G.SANKEERTH	CSE	III
12	D SAITEJA	ECE	III
13	G SAI KUMAR	ECE	III
14	SAI TEJA	ECE	III
15	M.JAIPAL	ECE	III
16	K.VISHNU	ECE	III

PRINCIPAL
MAHAVEER
INSTITUTE OF SCIENCE & TECHNOLOGY
Bandlaguda, Hyd-500 005.



Vysapuri, Bandlaguda Post:Keshavgiri,
Hyderabad-500 005, TELANGANA INDIA
Tel: 040-64596979,8978380692,
Fax: 040-24455003
E-mail: principal.mahaveer@gmail.com,
Website: www.mist.ac.in,

MAHAVEER

Approved by AICTE, Affiliated to JNTUH,Hyd.



Date: 23/9/2017

CIRCULAR

Sub: Indian Association for the blind

All the faculty members and students are here by informed that "Indian Association for the blind" will be organised by NSS unit of Mahaveer Institute Of Science and Technology is scheduled on 25TH SEPTEMBER 2018 between 9.30AM to 2.00PM in our college campus. Students, teaching and non-teaching staff members are requested to participate this event.

Copy to:

All Hod's, Principal
polytechnic, Exam
Branch incharge,
Librarian

PRINCIPAL

PRINCIPAL
MAHAVEER
INSTITUTE OF SCIENCE & TECHNOLOGY
Bandlaguda, Hyd-500 005.

PRINCIPAL
MAHAVEER
INSTITUTE OF SCIENCE & TECHNOLOGY
Bandlaguda, Hyd-500 005.



Vysapuri, Bandlaguda Post:Keshavgi,
Hyderabad-500 005, TELANGANA INDIA
Tel: 040-64596979,8978380692.
Fax: 040-24455003
E-mail: principal.mahaveer@gmail.com
Website: www.mist.ac.in.

MAHAVEER
INSTITUTE OF SCIENCE & TECHNOLOGY
Approved by AICTE, Affiliated to JNTUH,Hyd.



Dt:25/09/2018

Programmeme 10: Indian Association for the blind

Indian Association for the Blind Nestled in the village of Sundarajanpatty in the outer fringes of Madhurai in Tamilnadu, IAB has been the pioneer in empowering the visually challenged towards self-reliance through various initiatives like *Education, Carees & Skills Training, Residential Services, Support Services and employment.*

With the reference of IAB our college NSS cell collected and donated *Two Thousand Rupees* to the IAB in the form of cheque. On behalf of IAB they sent Appreciation letter also.



Kishu
PRINCIPAL
MAHAVEER
INSTITUTE OF SCIENCE & TECHNOLOGY

Vysapuri, Bandlaguda Post Keshavgiri,
Hyderabad-500 005, TELANGANA INDIA
Tel: 040-64596979,8978380692
Fax: 040-24455003
E-mail: principal.mahaveer@gmail.com
Website: www.mist.ac.in,

MAHAVEER

Approved by AICTE, Affiliated to JNTU(H) Hydr



Dt: 25/09/2018

EVENT NAME: Indian Association for the blind

ORGANIZING COMMITTEE

Student organizing members:

S NO	STUDENT NAME	BRANCH	YEAR
1	P RAVI KUMAR	CIVIL	III
2	G NIRANJAN SAI	CIVIL	III
3	D PRASANNA YADAV	CIVIL	III

Faculty organizing members:

S NO	NAME OF THE FACULTY	DESIGNATION	DEPT
1	Dr M VASANTHA LAKSHMI	ASSOCIATE PROFESSOR	CIVIL

K. Subh
PRINCIPAL
MAHAVEER
INSTITUTE OF SCIENCE & TECHNOLOGY
Bandlaguda, Hyderabad

Vysapuri, Bandlaguda Post:Keshavgi,
Hyderabad-500 005, TELANGANA INDIA
Tel: 040-64596979,8978380692,
Fax: 040-24455003
E-mail: principal.mahaveer@gmail.com
Website: www.mist.ac.in,

MAHAVEER

Approved by AICTE, Affiliated to JNTUH,Hyd



Dt: 25/09/2018

EVENT NAME:Indian Association for the blind

Student Participation List

S NO	STUDENT NAME	BRANCH	YEAR
1	P KEERTHIMADHURI	CIVIL	III
2	MD NADEEM UDDIN	CIVIL	IV
3	MD BABU	CIVIL	II
4	SANA	CIVIL	II
5	B SIVASHANKAR NAIK	EEE	I
6	KISHORE	MECH	IV
7	G BHANU	CIVIL	III
8	Y CHAITANYA	MECH	III
9	MD LEQMAN ZALIM	MECH	II
10	B NIKHIL TEJ	MECH	I
11	ABDUL RAZZAK	CMT	I
12	P RAVI KUMAR	CIVIL	III
13	G NIRAUJANSAI	CIVIL	III
14	D PRASANNA YADAV	CIVIL	III

Kanhu
PRINCIPAL
MAHAVEER
INSTITUTE OF SCIENCE & TECHNOLOGY
Bandlaguda, Hyd-500 005.

Vysapuri, Bandlaguda Post:Keshavgi,
Hyderabad-500 005, TELANGANA INDIA
Tel: 040-64596979,8978380692,
Fax: 040-24455003
E-mail: principal.mahaveer@gmail.com,
Website: www.mist.ac.in,

MAHAVEER



Approved by AICTE, Affiliated to JNTUH,Hyd.

Date: 13/10/17

CIRCULAR

Sub: Blood Donation camp at police Commissionerate

All the faculty members and students are hereby informed that **"Blood Donation camp at police Commissionerate"** will be organised by NSS unit of Mahaveer Institute Of Science and Technology in Association is scheduled on **17TH OCTOBER 2017** between 9.30AM to 2.00PM in Dr.ronald ross blood bank. Students, teaching and non-teaching staff members are requested to participate this event.

Copy to:

All Hod's, Principal
polytechnic, Exam
Branch incharge,
Librarian

PRINCIPAL
MAHAVEER
INSTITUTE OF SCIENCE & TECHNOLOGY
Bandlaguda, Hyd-500 005.

PRINCIPAL

PRINCIPAL
MAHAVEER
INSTITUTE OF SCIENCE & TECHNOLOGY
Bandlaguda, Hyd-500 005.

Vysapuri, Bandlaguda Post:Keshavgi,
Hyderabad-500 005, TELANGANA INDIA
Tel: 040-64596979,8978380692.
Fax: 040-24455003
E-mail: principal.mahaveer@gmail.com
Website: www.mist.ac.in.

MAHAVEER
INSTITUTE OF SCIENCE & TECHNOLOGY
Approved by AICTE, Affiliated to JNTUH,Hyd.



Dt: 17/10/17

Programme 11: Blood Donation camp at police Commissionerate

On *Martyrs Reform Week*, who had sacrificed their lives, Blood donation camp was organized, for this NSS Cell MIST took out 19 members of our college students to donated blood to *Dr. Ronald Ross Blood Bank* on 17th OCTOBER 2017 between 9.30AM to 2.00PM at *Police Commnerate Cyberabad Gachobowli*.



K. Mahaveer
PRINCIPAL
MAHAVEER
INSTITUTE OF SCIENCE & TECHNOLOGY

Vysapuri, Bandlaguda Post:Keshavgiri,
Hyderabad-500 005, TELANGANA INDIA
Tel: 040-64596979,8978380692,
Fax: 040-24455003
E-mail: principal.mahaveer@gmail.com
Website: www.mist.ac.in,

MAHAVEER

Approved by AICTE, Affiliated to JNTUH,Hyd



Dt: 17/10/2017

EVENT NAME: BLOOD DONATION CAMP AT POLICE COMMISSIONARATE

ORGANIZING COMMITTEE

Student organizing members:

S NO	STUDENT NAME	BRANCH	YEAR
1	G SUHRUDH	CIVIL	IV
2	MD IBRAHIM	CIVIL	IV
3	B RAGHURAM	CIVIL	IV

Faculty organizing members:

S NO	NAME OF THE FACULTY	DESIGNATION	DEPT
1	Dr M VASANTHA LAKSHMI	ASSOCIATE PROFESSOR	CIVIL

PRINCIPAL
MAHAVEER
INSTITUTE OF SCIENCE & TECHNOLOGY
Bandlaguda, Hyderabad-500 005.

Vysapuri, Bandlaguda Post:Keshavgiri,
Hyderabad-500 005, TELANGANA INDIA
Tel: 040-64596979,8978380692,
Fax: 040-24455003
E-mail: principal.mahaveer@gmail.com
Website: www.mist.ac.in,

MAHAVEER

Approved by AICTE, Affiliated to JNTUH,Hyd



Dt: 17/10/2017

EVENT NAME: BLOOD DONATION CAMP AT POLICE COMMISSIONARATE

Student Participation List

S NO	STUDENT NAME	BRANCH	YEAR
1	T SRIKANTH	MECH	II
2	B JAYAVARDHAN	MECH	I
3	M ABHISHEK	MECH	I
4	J MANISH	CSE	I
5	T SHRAVAN KUMAR	ECE	I
6	A SRIKANTH	ECE	I
7	CH SAI KRISHNA	ECE	I
8	C RAMESH	ECE	I
9	A SRAVAN	ECE	I
10	SHADMAN ASHRAF	MECH	III
11	B RAMANAİK	MECH	III
12	G SUHRUDH	CIVIL	IV
13	MD IBRAHİM	CIVIL	IV
14	B RAGHURAM	CIVIL	IV
15	H SANDEEP KUMAR	ECE	I
16	K SHYAM SUNDER RAO	ECE	I
17	P NAGA BHARGHAV	ECE	I
18	G RAJ KUMAR	ECE	I
19	N SRINAD REDDY	ECE	I

Kanthy

PRINCIPAL
MAHAVEER
INSTITUTE OF SCIENCE & TECHNOLOGY
Bandlaguda, Hyd-500 005.

Vysapuri, Bandlaguda Post:Keshavgiri,
Hyderabad-500 005, TELANGANA INDIA
Tel: 040-64596979,8978380692,
Fax: 040-24455003
E-mail: principal.mahaveer@gmail.com,
Website: www.mist.ac.in,

MAHAVEER

Approved by AICTE, Affiliated to JNTUH,Hyd.



Date: 09/01/2018

CIRCULAR

Sub: Blood Donation camp At college campus

All the faculty members and students are here by informed that "Blood Donation camp At college campus" will be organised by NSS unit of Mahaveer Institute Of Science and Technology in Association with rajya Laxmi charitable trust is scheduled on 12TH JANUARY 2018 between 9.30AM to 2.00PM in our college campus. Students, teaching and non-teaching staff members are requested to participate this event.

Copy to:

All Hod's, Principal
polytechnic, Exam
Branch incharge,
Librarian

Kshul
PRINCIPAL
MAHAVEER
INSTITUTE OF SCIENCE & TECHNOLOGY
Bandlaguda, Hyd-500 005.

Kshul
PRINCIPAL

PRINCIPAL
MAHAVEER
INSTITUTE OF SCIENCE & TECHNOLOGY
Bandlaguda, Hyd-500 005.

Vysapuri, Bandlaguda Post:Keshavgi,
Hyderabad-500 095, TELANGANA INDIA
Tel: 040-6459679,8978380692,
Fax: 040-24455003
E-mail: principal.mahaveer@gmail.com
Website: www.mist.ac.in.



Dt: 12/01/2018

Programme 12: Blood Donation camp At college campus

NSS unit of Mahaveer Institute Of Science and Technology in Association with *Raja Lakshmi Charitable Trust (Chaitanyapuri, Dishuknagar, hyd)* organized "Blood Donation Camp" on 12/01/2018 between 9.30AM to 2.00PM in MIST college campus coordinated by Dr K.K.iran Kumar and Dr M Vasantha laksmi along with NSS volunteers In this event College Chairman Samreddy Sudharshan Reddy, secretary Samreddy Surendar Reddy, Principal Dr.K.S.S.N reddy, Head of the Trust Ramana reddy ,teaching and non-teaching staff members and students were participated and they donated blood.



Ramana
PRINCIPAL

Vysapuri, Bandlaguda Post:Keshavgiri,
Hyderabad-500 005, TELANGANA INDIA
Tel: 040-64596979,8978380692,
Fax: 040-24455003
E-mail: principal.mahaveer@gmail.com
Website: www.mist.ac.in,

MAHAVEER

Approved by AICTE, Affiliated to JNTUH,Hyd.



Dt: 12/01/2018

EVENT NAME: BLOOD DONATION CAMP AT COLLEGE CAMPUS

ORGANIZING COMMITTEE

Student organizing members:

S NO	STUDENT NAME	BRANCH	YEAR
1	S MAHENDER	CSE	III
2	P.REETHIMA REDDY	CSE	III
3	G ASHOKE	CSE	III
4	K.VISHNU	ECE	III

Faculty organizing members:

S NO	NAME OF THE FACULTY	DESIGNATION	DEPT
1	Dr K KIRAN KUMAR	HOD, PROFESSOR	MBA

Kiran
PRINCIPAL
MAHAVEER
INSTITUTE OF SCIENCE & TECHNOLOGY
Bandlaguda, Hyd-500 005.

Vysapuri, Bandlaguda Post:Keshavgi,
Hyderabad-500 005, TELANGANA INDIA
Tel: 040-64596979,8978380692,
Fax: 040-24455003
E-mail: principal.mahaveer@gmail.com
Website: www.mist.ac.in,

MAHAVEER

Approved by AICTE, Affiliated to JNTUH,Hyd.



Dt: 12/01/2018

EVENT NAME: BLOOD DONATION CAMP AT COLLEGE CAMPUS

Student Participation List

S NO	STUDENT NAME	BRANCH	YEAR
1	JUJJURU SAINADH	ECE	IV
2	P NAVEEN KUMAR	ECE	IV
3	TUMMANAPELLI VENKATESH	ECE	IV
4	BALUSA VIVEK	MECH	IV
5	GORIGE RAVIKANTH	MECH	IV
6	P KRISHNA	MECH	IV
7	DOMMATA BHASKAR	EEE	IV
8	GANTE SANTHOSH	IT	IV
9	BATHARAJU ARUN KUMAR	CIVIL	IV
10	S NAGA NIKHIL	CSE	IV
11	BANDLA SRUJAN	CSE	IV
12	DEVARAMPALLY VISHAL REDDY	CSE	IV
13	BETHI BHARATH	MECH	III
14	DESHAGOUNI MOHAN SAI	MECH	III
15	BOBBALA ARAVIND REDDY	CSE	III
16	RAIKODU RAVIKISHOREREDDY	CSE	III
17	KAMBHAM NAVEEN REDDY	CSE	III
18	B RAKESH	ECE	III
19	D SAITEJA	ECE	III
20	BOMMA ABHISHEK	CIVIL	III
21	M AVINASH	CIVIL	III
22	DUMALA VENU	IT	III

K. Srinivas
PRINCIPAL
MAHAVEER
INSTITUTE OF SCIENCE & TECHNOLOGY
Bandlaguda, Hyd-500 005.

Vysapuri, Bandlaguda Post:Keshavgiri,
Hyderabad-500 005, TELANGANA INDIA
Tel: 040-64596979,8978380692,
Fax: 040-24455003
E-mail: principal.mahaveer@gmail.com,
Website: www.mist.ac.in,

MAHAVEER

Approved by AICTE, Affiliated to JNTUH,Hyd.



Date: 29/11/2017

CIRCULAR

Sub: Distribution of Dustbins

All the faculty members and students are here by informed that **"Distribution of Dustbins"** will be organised by NSS unit of Mahaveer Institute Of Science and Technology is scheduled on **01ST DECEMBER 2017** between 9.30AM to 2.00PM in our college campus. Students, teaching and non-teaching staff members are requested to participate this event.

Copy to:
All Hod's, Principal
polytechnic, Exam
Branch incharge,
Librarian

PRINCIPAL
MAHAVEER
INSTITUTE OF SCIENCE & TECHNOLOGY
Bandlaguda, Hyd-500 005.

PRINCIPAL
MAHAVEER
INSTITUTE OF SCIENCE & TECHNOLOGY
Bandlaguda, Hyd-500 005.

Vysapuri, Bandlaguda Post:Keshavgi,
Hyderabad-500 005, TELANGANA INDIA
Tel: 040-64596979,8978380692.
Fax: 040-24455003
E-mail: principal.mahaveer@gmail.com
Website: www.mist.ac.in.

MAHAVEER
INSTITUTE OF SCIENCE & TECHNOLOGY
Approved by AICTE, Affiliated to JNTUH,Hyd.



Dt: 01/12/2017

Programme 13: Distribution of Dustbins

As part of *Swatch campus* initiation "*Distribution of Dustbins*" organized by NSS unit of Mahaveer Institute Of Science and Technology is scheduled on 1st DECEMBER 2017 between 10.00AM to 12.00PM in our college campus. Dustbins given to all the departments , office and library of MIST campus and these are used in each and every class room to maintain neat and cleanliness of the class rooms as well as campus.



K. Srinivas
PRINCIPAL
MAHAVEER

Vysapuri, Bandlaguda Post:Keshavgiri,
Hyderabad-500 005, TELANGANA INDIA
Tel: 040-64596979,8978380692,
Fax: 040-24455003
E-mail: principal.mahaveer@gmail.com
Website: www.mist.ac.in,

MAHAVEER

Approved by AICTE, Affiliated to JNTUH,Hyd.



Dt: 10/1/2018

EVENT NAME:NATIONAL YOUTH DAY CELEBRATIONS

ORGANIZING COMMITTEE

Student organizing members:

S NO	STUDENT NAME	BRANCH	YEAR
1	P SRICHAITANYA	CIVIL	III
2	V DEVENDER	IT	III
3	BOSI ANKUSH	ECE	III
4	G PRANEETH REDDY	ECE	III

Faculty organizing members:

S NO	NAME OF THE FACULTY	DESIGNATION	DEPT
1	Dr M VASANTHA LAKSHMI	ASSOCIATE PROFESSOR	CIVIL

PRINCIPAL
MAHAVEER
INSTITUTE OF SCIENCE & TECHNOLOGY
Bandlaguda, Hyd-500 005.

Vysapuri, Bandlaguda Post:Keshavgiri,
Hyderabad-500 005, TELANGANA INDIA
Tel: 040-64596979,8978380692,
Fax: 040-24455003
E-mail: principal.mahaveer@gmail.com
Website: www.mist.ac.in,

MAHAVEER

Approved by AICTE, Affiliated to JNTUH,Hyd.



37	A SRINIVAS KALYAN	ECE	III
38	ABHILAS REDDY	ECE	II
39	B PRADEEP	ECE	II
40	GANGIREDDY MAHENDER	ECE	II
41	K ANIL KUMAR	ECE	II
42	MURUGESHAN SAI SUNDER	ECE	II
43	MEELA JASHWANTH	ECE	II
44	REGULA CHANDRAKANTH	ECE	II
45	SALADI NITISH PHANI	ECE	II
46	K GURUJOSHAN	ECE	II
47	K SAI SRIVASTA	ECE	II
50	K GREESHMA REDDY	IT	III
51	V DEVENDER	IT	III
52	K HAREESH SAGAR	IT	III
53	CH CHAITANYA	IT	II
54	S GAYATRI	IT	II
55	M BHAGHYALAKSHMI	IT	III
56	B UPENDRA	IT	III
57	R VAISHNAVI	IT	II
58	SAI KRISHNA	IT	II
59	K DINESH	IT	II
60	P PRAVALLIKA	CIVIL	III
61	P SRICHAITANYA	CIVIL	III
62	P KEERTHI MADHURI	CIVIL	III
63	P PRANAY	CIVIL	III
64	G MANEESH	CIVIL	III
65	D VIJAY	CIVIL	III
66	MD ANSARI	CIVIL	III
67	MD SALAM CHOUDARY	CIVIL	III
68	MD ETHESHAM	CIVIL	III
69	E TEJASWINI	CIVIL	III

Kishu
PRINCIPAL
MAHAVEER
INSTITUTE OF SCIENCE & TECHNOLOGY
Bandlaguda, Hyderabad-500 005.

Vysapuri, Bandlaguda Post:Keshavgiri,
Hyderabad-500 005, TELANGANA INDIA
Tel: 040-64596979,8978380692,
Fax: 040-24455003
E-mail: principal.mahaveer@gmail.com
Website: www.mist.ac.in,

MAHAVEER

Approved by AICTE, Affiliated to JNTUH,Hyd.



Dt: 10/1/2018

EVENT NAME: NATIONAL YOUTH DAY CELEBRATIONS

Student Participation List

S NO	STUDENT NAME	BRANCH	YEAR
1	P SAI KUMAR	CSE	II
2	M SAI KUMAR	CSE	II
3	J AKASH REDDY	CSE	II
4	K CHANDRASHEKAR REDDY	CSE	II
5	K SAINATH	CSE	II
6	J MANEESHA	CSE	III
7	K MAHESHWARI	CSE	III
8	SRUTHISHARMA	CSE	III
9	A GAYATRISUSHMA	CSE	III
10	G SUSHMA	CSE	III
11	DESHWAL VENEETH	EEE	II
12	ABDUL RAHEEM	EEE	II
13	JADAV SATHEESH	EEE	II
14	S KRISHNA VAMSHI	EEE	II
15	RAJARAPU VIJAY	EEE	II
16	ROSHAN PATNAIK	EEE	II
17	P SIRISHA YADAV	EEE	III
18	B ARAVIND KUMAR	EEE	III
19	K MADHU	EEE	III
20	RATHOD AMBADAS	EEE	III
21	A VAMSHIKRISHNA	EEE	III
22	J ANJANEYULU	EEE	III
23	P NARSINGH	EEE	III
24	V RANEETH KUMAR	EEE	III
25	Y JEEVANA DURGHAVEVI	EEE	III
26	A NISHITHA	EEE	III
27	A VENKATAKRISHNA VAMSHI	ECE	III
28	A VINAYKUMAR	ECE	III
29	A BALAKRISHNA GOUD	ECE	III
30	BODDU YASU	ECE	III
31	G KIRAN REDDY	ECE	III
32	TRIPATI SURYATEJA	ECE	III
33	BOSI ANKUSH	ECE	III
34	V CHANDRASHEKAR	ECE	III
35	DARAVATH SHIVA KUMAR	ECE	III
36	G PRANEETH REDDY	ECE	III

K. S. S.
PRINCIPAL
MAHAVEER
INSTITUTE OF SCIENCE & TECHNOLOGY
Bandlaguda, Hyd-500 005.

Vysapuri, Bandlaguda Post:Keshavgiri,
Hyderabad-500 005, TELANGANA INDIA
Tel: 040-64596979,8978380692,
Fax: 040-24455003
E-mail: principal.mahaveer@gmail.com
Website: www.mist.ac.in.

MAHAVEER

Approved by AICTE, Affiliated to JNTUH,Hyd.



Dt: 10/1/2018

Programmeme 14: National Youth day celebrations

Programme was conducted by *Ramakrishna Math* as part of *156 Birthday of SWAMI VIVEKANANDA*, It is a three day programme i.e 10/1/2018 to 12/1/2018, for this introduction given by *Swami Bodhamayananda* Benediction by *Swami Jnanadanandaji Maharaj* and speakers of the programme were Dr. Akun sabharwal IPS, Dr. K.S Ratnakar director Global hospitals Hyderabad, Sri Vijay Menon Human Resources Academician Kochi, Sri Sharad Vivek Sagar Founder and CEO of Dexterity global patna , and Sri SGK Kishore CEO GMR Hyderabad International airport limited.

First day was *Convention For Dentists/Medicos At VIHE Auditorium* with the theme *Human Excellence and Service* benediction given by Swami Bodhamayananda and addressed by Dr. Akun sabharwal IPS, Dr. K.S Ratnakar, and Dr. S. Chetan Kumar.

Second day was *Youth Convention for UG , PG and Young Professional* at Vivekananda Auditorium Addressed by Sri Sharad Sagar and Sri SGK Kishore

Third day was *National youth day and youth Convention* at Vivekananda Auditorium Addressed by Sri Vijay Menon.

Almost 66 students along with faculty coordinators of different branches from Mahaveer college were participated in this programme.

Kishore
PRINCIPAL
MAHAVEER
INSTITUTE OF SCIENCE & TECHNOLOGY
Bandlaguda, Hyd-500 005.

Vysapuri, Bandlaguda Post:Keshavgiri,
Hyderabad-500 005, TELANGANA INDIA
Tel: 040-64596979,8978380692,
Fax: 040-24455003
E-mail: principal.mahaveer@gmail.com,
Website: www.mist.ac.in,

MAHAVEER

Approved by AICTE, Affiliated to JNTUH,Hyd.



Date: 08/1/2018

CIRCULAR

Sub: National Youth day celebrations

All the faculty members and students are here by informed that "National Youth day celebrations" will be organised by NSS unit of Mahaveer Institute Of Science and Technology in Association with RAMAKRISHNA MATH is scheduled on 10TH JANUARY 2018 between 9.30AM to 2.00PM in Ramakrishna math. Students, teaching and non-teaching staff members are requested to participate this event.

Copy to:

All Hod's, Principal
polytechnic, Exam
Branch incharge,
Librarian

PRINCIPAL
MAHAVEER
INSTITUTE OF SCIENCE & TECHNOLOGY
Bandlaguda, Hyd-500 005.

PRINCIPAL

PRINCIPAL
MAHAVEER
INSTITUTE OF SCIENCE & TECHNOLOGY
Bandlaguda, Hyd-500 005.

Vysapuri, Bandlaguda Post:Keshavgiri,
Hyderabad-500 005, TELANGANA INDIA
Tel: 040-64596979,8978380692,
Fax: 040-24455003
E-mail: principal.mahaveer@gmail.com
Website: www.mist.ac.in,

MAHAVEER

Approved by AICTE, Affiliated to JNTUH,Hyd.



Dt: 01/12/2017

EVENT NAME:DISTRIBUTION OF DUSTBINS

ORGANIZING COMMITTEE

Student organizing members:

S NO	STUDENT NAME	BRANCH	YEAR
1	G.RAJESH	CSE	III
2	K SRUTEJA	CSE	III
3	N CHAITANYA YADAV	CSE	III

Faculty organizing members:

S NO	NAME OF THE FACULTY	DESIGNATION	DEPT
1	Dr M VASANTHA LAKSHMI	ASSOCIATE PROFESSOR	CIVIL

Keshav
PRINCIPAL
MAHAVEER
INSTITUTE OF SCIENCE & TECHNOLOGY
Bandlaguda, Hyd-500 005.

Vysapuri, Bandlaguda Post:Keshavngrh,
Hyderabad-500 005, TELANGANA INDIA
Tel: 040-04596970,8976380092,
Fax: 040-24455003
E-mail: principal.mahaveer@gmail.com
Website: www.mist.ac.in,

MAHAVEER

Approved by AICTE, Affiliated to JNTUH Hyd



De: 01/12/2017

EVENT NAME: DISTRIBUTION OF DUSTBINS

Student Participation List

S NO	STUDENT NAME	BRANCH	YEAR
1	BYREDDY SRIDEVI	ECE	II
2	THOGUTE NAGARAJ	ECE	II
3	JADAV SATHISH	AERO	II
4	BADAM ABILASH	CSE	II
5	RIKKA VANDANA	CSE	II
6	BAGADE SURAJ KUMAR	CSE	II
7	J NIKITHA	CSE	II
8	KARING DINESH	IT	II
9	KINAK PAVAN	MECH	II

Kanish
PRINCIPAL
MAHAVEER
INSTITUTE OF SCIENCE & TECHNOLOGY
Bandlaguda, Hyd-500 005.

Vysapuri, Bandlaguda Post:Keshavgiri,
Hyderabad-500 005, TELANGANA INDIA
Tel: 040-64596979,8978380692,
Fax: 040-24455003
E-mail: principal.mahaveer@gmail.com,
Website: www.mist.ac.in,

MAHAVEER

Approved by AICTE, Affiliated to JNTUH,Hyd.



Date: 18/1/2018

CIRCULAR

Sub: Swatch sarvekshan

All the faculty members and students are here by informed that "Swatch sarvekshan" will be organised by NSS unit of Mahaveer Institute Of Science and Technology in Association with RAJENDRA NAGAR MUNICIPALITY is scheduled on 20TH JANUARY 2018 between 9.30AM to 2.00PM AT RAJENDRA NAGAR. Students, teaching and non-teaching staff members are requested to participate this event.

PRINCIPAL
MAHAVEER

INSTITUTE OF SCIENCE & TECHNOLOGY
Bandlaguda, Hyd-500 005.

PRINCIPAL

PRINCIPAL
MAHAVEER
INSTITUTE OF SCIENCE & TECHNOLOGY
Bandlaguda, Hyd-500 005.

Copy to:

All Hod's, Principal
polytechnic, Exam
Branch incharge,
Librarian

Vysapuri, Bandlaguda Post:Keshavgiri,
Hyderabad-500 005, TELANGANA INDIA
Tel: 040-64596979,8978380692,
Fax: 040-24455003
E-mail: principal.mahaveer@gmail.com
Website: www.mist.ac.in.

MAHAVEER
INSTITUTE OF SCIENCE & TECHNOLOGY
Approved by AICTE, Affiliated to JNTUH,Hyd.



Dt: 20/01/2018

Programme 15: Swatch sarvekshan

This programme was organized by *NSS Unit* of Mahaveer Institute of Science and Technology with the help of *Rajendra Nagar Municipality* was scheduled on 20/01/2018 lakshmi Guda, Durga Nagar colony,.

In Swatch Sarvekshan programme 90 members of II Yr mechanical students were participated in this programme and they did door to door survey on *Dry and Wet Waste Segregation* and they gave *Awareness On Antiplastic Waste Management* under the guidance of *V.Bhaskar Zonal coordinator* and NSS coordinator *Dr.M.Vasantha Lakshmi*.



K. Srinivas
PRINCIPAL
MAHAVEER

Vysapuri, Bandlaguda Post:Keshavgiri,
Hyderabad-500 005, TELANGANA INDIA
Tel: 040-64596979,8978380692,
Fax: 040-24455003
E-mail: principal.mahaveer@gmail.com
Website: www.mist.ac.in,

MAHAVEER

Approved by AICTE, Affiliated to JNTUH,Hyd



Dt: 20/1/2018

EVENT NAME:SWATCH SARVEKSHAN

ORGANIZING COMMITTEE

Student Organizing Members:

S NO	STUDENT NAME	BRANCH	YEAR
1	S MAHENDER REDDY	CSE	III
2	G.RAJESH	CSE	III
3	N.CHAITANYA	CSE	III
4	M.JAIPAL	ECE	III
5	K.VISHNU	ECE	III

Faculty organizing members:

S NO	NAME OF THE FACULTY	DESIGNATION	DEPT
1	Dr M VASANTHA LAKSHMI	ASSOCIATE PROFESSOR	CIVIL

Keshav
PRINCIPAL
MAHAVEER
INSTITUTE OF SCIENCE & TECHNOLOGY
Bandlaguda, Hyd-500 005.

Vysapuri, Bandlaguda Post:Keshavgiri,
Hyderabad-500 005, TELANGANA INDIA
Tel: 040-64596979,8978380692,
Fax: 040-24455003
E-mail: principal.mahaveer@gmail.com
Website: www.mist.ac.in,

MAHAVEER

Approved by AICTE, Affiliated to JNTUH,Hyd.



84	T VINAY GOUD	MECH	II
85	V SHIVA KUMAR REDDY	MECH	II
86	V NIKHIL KUNMAR	MECH	II
87	Y VISHNUVARDHAN REDDY	MECH	II
88	K SAITEJA	MECH	II
89	B VENKATASAI	MECH	II
90	B SRINATH	MECH	II

PRINCIPAL
MAHAVEER
INSTITUTE OF SCIENCE & TECHNOLOGY
Bandlaguda, Hyd-500 005.

Vysapuri, Bandlaguda Post:Keshavgi,
Hyderabad-500 005, TELANGANA INDIA
Tel: 040-64596979,8978380692,
Fax: 040-24455003
E-mail: principal.mahaveer@gmail.com
Website: www.mist.ac.in,

MAHAVEER

Approved by AICTE, Affiliated to JNTUH,Hyd.



37	K KARTHEEK	MECH	II
38	K PAVAN KUMAR	MECH	II
39	MAHESH	MECH	II
40	MD ASIF	MECH	II
41	M NARENDRA	MECH	II
42	MD ABDUL RAKED	MECH	II
43	MD SAFIYUDDINKHAN	MECH	II
44	P NAGAVAMSHI	MECH	II
45	P TARUN KUMAR	MECH	II
46	P BHANUCHANDRA	MECH	II
47	S RAGHVENDRA REDDY	MECH	II
50	SHAIK MINHJUDDIN	MECH	II
51	SYED SOHAIL AHMED	MECH	II
52	V SRIKANTH	MECH	II
53	MD ABDUL HASEEB	MECH	II
54	L SURENDRA REDDY	MECH	II
55	G CHARAN	MECH	II
56	P SRICHGAITANYA	MECH	II
57	G MANEESH	MECH	II
58	MD SALMON CHOWDARY	MECH	II
59	ABU SUFYAN MALIK	MECH	II
60	AAKASH SABHNANI	MECH	II
61	A ANIL KUMAR	MECH	II
62	A SHIVA	MECH	II
63	B VIJENDER REDDY	MECH	II
64	DEVISRI PRASHANTH	MECH	II
65	E SAIRAM	MECH	II
66	E MAHENDRA KUMAR	MECH	II
67	ISHRATH UNNISA BEGUM	MECH	II
68	K SRINU REDDY	MECH	II
69	K RAJASHEKHAR REDDY	MECH	II
70	K SRAVAN REDDY	MECH	II
71	K ANUSHA	MECH	II
72	K AKHL	MECH	II
73	M AKHIL TEJA	MECH	II
74	MD AMJAD ALI	MECH	II
75	MD LUQMON ZAKI	MECH	II
76	MD RIZANUDDIN	MECH	II
77	P JAGADEESH	MECH	II
78	P JAGADEESHWAR REDDY	MECH	II
79	P PRASHANTH KUMAR	MECH	II
80	SHAIK SAMER	MECH	II
81	SYED AHMED	MECH	II
82	SYED OMAIR AHMED	MECH	II
83	SYEDA RUMAN	MECH	II

Kishu
PRINCIPAL
MAHAVEER
INSTITUTE OF SCIENCE & TECHNOLOGY
Bandlaguda, Hyd-500 005

Vysapuri, Bandlaguda Post:Keshavgiri,
Hyderabad-500 005, TELANGANA INDIA
Tel: 040-64596979,8978380692,
Fax: 040-24455003
E-mail: principal.mahaveer@gmail.com
Website: www.mist.ac.in,

MAHAVEER

Approved by AICTE. Affiliated to JNTUH Hyd



Dt: 20/1/2018

EVENT NAME: SWATCH SARVEKSHAN

Student Participation List

S NO	STUDENT NAME	BRANCH	YEAR
1	B PRAVEEN KUMAR	MECH	II
2	G RAMAKRISHNA	MECH	II
3	G VENUGOPAL	MECH	II
4	G SUDHAMSHU	MECH	II
5	G VAMSHI KRISHNA	MECH	II
6	K SAI KUMAR	MECH	II
7	L GANESH	MECH	II
8	MD MUBEENQURESHI	MECH	II
9	MD ABDUL SAMEER	MECH	II
10	MD ABDUL AHTHESHAM UL HASANAJN	MECH	II
11	N SRIKANTH REDDY	MECH	II
12	N TEJASWI	MECH	II
13	P SAI KIRAN GOUD	MECH	II
14	P PRASHANTH REDDY	MECH	II
15	T UPENDRA	MECH	II
16	P ANIL	MECH	II
17	P RAJ CHAVAN	MECH	II
18	P YADALAH	MECH	II
19	R VAYUPUTHRA	MECH	II
20	L RAMAKRISHNA	MECH	II
21	R HEMANTH KUMAR	MECH	II
22	SAIK MUZAFAR	MECH	II
23	SYED ZAINUDDIN ABED	MECH	II
24	T SRIKANTH	MECH	II
25	T NARAYANA	MECH	II
26	TY PAVAN KUKMAR	MECH	II
27	Y SHREYA	MECH	II
28	K RAJESH	MECH	II
29	MD ABUBAKAR SIDDIQ	MECH	II
30	A SWARAJYAM	MECH	II
31	B MAHESH	MECH	II
32	B VEKATA SAI	MECH	II
33	B SRIKANTH	MECH	II
34	G HARSHAVARDHAN	MECH	II
35	J SAI KUMAR	MECH	II
36	K SURESH	MECH	II

Kishu
PRINCIPAL
MAHAVEER
INSTITUTE OF SCIENCE & TECHNOLOGY
Bandlaguda, Hyd-500 005.

Vysapuri, Bandlaguda Post:Keshavgi,
Hyderabad-500 005, TELANGANA INDIA
Tel: 040-64596979,8978380692,
Fax: 040-24455003
E-mail: principal.mahaveer@gmail.com,
Website: www.mist.ac.in,

MAHAVEER



Approved by AICTE, Affiliated to JNTUH,Hyd.

Date: 20/1/2018

CIRCULAR

Sub: VIVEKA SUBHASHITAM

All the faculty members and students are here by informed that "VIVEKA SUBHASHITAM" will be organised by NSS unit of Mahaveer Institute Of Science and Technology together with RAMAKRISHNA MATH is scheduled on 23RD JANUARY 2018 between 10:0AM to 4.00PM conducted at RAMAKRISHNA MATH student and teaching and non-teaching staff members are requested to participate this event.

Copy to:
All Hod's, Principal
polytechnic, Exam
Branch incharge,
Librarian

PRINCIPAL
MAHAVEER
INSTITUTE OF SCIENCE & TECHNOLOGY
Bandlaguda, Hyd-500 005.

PRINCIPAL

PRINCIPAL
MAHAVEER
INSTITUTE OF SCIENCE & TECHNOLOGY
Bandlaguda, Hyd-500 005.

Vysapuri, Bandlaguda Post:Keshavgi,
Hyderabad-500 005, TELANGANA INDIA
Tel: 040-64596979,8978380692.
Fax: 040-24455003
E-mail: principal.mahaveer@gmail.com
Website: www.mist.ac.in.

MAHAVEER
INSTITUTE OF SCIENCE & TECHNOLOGY
Approved by AICTE, Affiliated to JNTUH,Hyd.



Dt: 23/01/2018

Programmeme 16: Viveka Subhashitam

Viveka subhashitam –Youth for Nation programme was conducted at *Ramakrishna Math* on 23/01/2018, The students from all the branches of Mahaveer Institute of science and technology along with their faculty members each faculty member from each department were participated.



K. Srinivas
PRINCIPAL
MAHAVEER
INSTITUTE OF SCIENCE & TECHNOLOGY

Vysapuri, Bandlaguda Post:Keshavglri,
Hyderabad-500 005, TELANGANA INDIA
Tel: 040-64596979,8978380692,
Fax: 040-24455003
E-mail: principal.mahaveer@gmail.com
Website: www.mist.ac.in,

MAHAVEER

Approved by AICTE, Affiliated to JNTUH,Hyd



Dt: 03/02/2018

EVENT NAME:22ND NATIONAL YOUTH FESTIVAL

ORGANIZING COMMITTEE

Student organizing members:

S NO	STUDENT NAME	BRANCH	YEAR
1	K.VISHNU	ECE	III
2	D SAITEJA	ECE	III
3	G.SANKEERTH	CSE	III
4	BHS LAHARI	CSE	III
5	SRUTEJA	CSE	III
6	K RAVI KISHORE	CSE	III

Faculty organizing members:

S NO	NAME OF THE FACULTY	DESIGNATION	DEPT
1	Dr M VASANTHA LAKSHMI	ASSOCIATE PROFESSOR	CIVIL

PRINCIPAL
MAHAVEER
INSTITUTE OF SCIENCE & TECHNOLOGY
Bandlaguda, Hyd-500 005.

Vysapuri, Bandlaguda Post:Keshavgi,
Hyderabad-500 005, TELANGANA INDIA
Tel: 040-64596979,8978380692,
Fax: 040-24455003
E-mail: principal.mahaveer@gmail.com
Website: www.mist.ac.in,

MAHAVEER

Approved by AICTE, Affiliated to JNTUH,Hyd.



Dt: 03/2/2018

EVENT NAME: 22ND NATIONAL YOUTH FESTIVAL

Student Participation List

S NO	STUDENT NAME	BRANCH	YEAR
1	MD RAYEES	MECH	I
2	P BHARGHAV KUMAR	MECH	I
3	SADBIN SIKENDER	MECH	I
4	YASHASWINI	AERO	I
5	AAYUSHMAN DUBE	AERO	I
6	ARSHI FIRDAUSH	CIVIL	I
7	K KEERTHI	AERO	I
8	D KIRAN KUMAR	CSE	III
9	SAINADH REDDY	ECE	I
10	P NAGABHARGHAV	ECE	I
11	D BALRAM	ECE	I
12	P KEERTHI MADHURI	CIVIL	III
13	B YAKKANNA	ECE	III
14	B HARINI	ECE	III
15	B SPOORTHI	ECE	III
16	B KRISHNA SAI	CSE	III
17	G SANKEERTH	CSE	III
18	M SANDHYA	CSE	III
19	M PRASHNATH	CIVIL	III
20	A SPANDANA	AERO	I
21	M MAHESH	MECH	I

PRINCIPAL
MAHAVEER
INSTITUTE OF SCIENCE & TECHNOLOGY
Bandlaguda, Hyd-500 005.

Vysapuri, Bandlaguda Post:Keshavgiri,
Hyderabad-500 005, TELANGANA INDIA
Tel: 040-64596979,8978380692,
Fax: 040-24455003
E-mail: principal.mahaveer@gmail.com
Website: www.mist.ac.in.

MAHAVEER

Approved by AICTE, Affiliated to JNTUH,Hyd.



Dt: 03/2/2018

Programmeme 17: 22nd National youth festival

This programme is for deputing the *NSS volunteers for the University Level NSS Youth Festival* organized on 3/2/2018, for this college level competitions were conducted and from that students some students were selected as a volunteers for University level youth festival competitions these students have to got a chance to go to the State level Youth festival which will be organized in the month of February 2018 at *Kakatiya University Warangal*.

The selection of NSS volunteers were done by according to the guidelines given by *NSS programmeme Coordinator Dr. P. Sammul Associate Professor in CSE department JNTUH*. In this youth festival different activities were held like *Literary, Creative Arts and performing Arts*.

20 members of Mahaveer Students were participated in this programme out of these *Two students were selected for sate level youth festival*, In this state level youth festival Conducted at the kakatiya University 150 colleges were participated, Ayushman Duby from I yr Aeronautical student Of Mahaveer Institute of science and technology won the prize

PRINCIPAL
MAHAVEER
INSTITUTE OF SCIENCE & TECHNOLOGY
Bandlaguda, Hyd-500 005.

Vysapuri, Bandlaguda Post:Keshavgirl,
Hyderabad-500 005, TELANGANA INDIA
Tel: 040-64596979,8978380692,
Fax: 040-24455003
E-mail: principal.mahaveer@gmail.com,
Website: www.mist.ac.in,

MAHAVEER



Approved by AICTE, Affiliated to JNTUH.Hyd.

Date: 01/2/2018

CIRCULAR

Sub: 22nd National youth festival

All the faculty members and students are here by informed that "22nd National youth festival" will be organised by NSS unit of Mahaveer Institute Of Science and Technology in Association kakatiya university is scheduled on 3RD FEBRUARY 2018 between 9.30AM to 2.00PM in Warangal. Students, teaching and non-teaching staff members are requested to participate this event.

Copy to:

All Hod's, Principal
polytechnic, Exam
Branch incharge,
Librarian

PRINCIPAL
MAHAVEER
INSTITUTE OF SCIENCE & TECHNOLOGY
Bandlaguda, Hyd-500 005.

PRINCIPAL

PRINCIPAL
MAHAVEER
INSTITUTE OF SCIENCE & TECHNOLOGY
Bandlaguda, hyd-500 005.

Vysapuri, Bandlaguda Post, Keshavgiri,
Hyderabad-500 005, TELANGANA INDIA
Tel: 040-64596979, 8978380692
Fax: 040-24455003
E-mail: principal.mahaveer@gmail.com
Website: www.mist.ac.in

MAHAVEER

Approved by AICTE. Affiliated to JNTUH, Hyd



Dt: 23/1/2018

EVENT NAME: VIVEKA SUBHASHITAM

ORGANIZING COMMITTEE

Student organizing members:

S NO	STUDENT NAME	BRANCH	YEAR
1.	S MAHENDER REDDY	CSE	III
2.	P. REETHIMA REDDY	CSE	III
3.	N. CHAITANYA	CSE	III
4.	G. RAJESH	CSE	III
5.	G. ASHOK	CSE	III
6.	SAI TEJA	ECE	III
7.	M. JAIPAL	ECE	III
8.	K. VISHNU	ECE	III
9.	PAVAN KUMAR	CIVIL	IV

Faculty organizing members:

S NO	NAME OF THE FACULTY	DESIGNATION	DEPT
1	Dr M VASANTHA LAKSHMI	ASSOCIATE PROFESSOR	CIVIL

K. S. S.

PRINCIPAL
MAHAVEER
INSTITUTE OF SCIENCE & TECHNOLOGY
Bandlaguda, Hyd-500 005

Vysapuri, Bandlaguda Post:Keshavglri,
Hyderabad-500 005, TELANGANA INDIA
Tel: 040-64596979,8978380692,
Fax: 040-24455003
E-mail: principal.mahaveer@gmail.com
Website: www.mist.ac.in,

MAHAVEER

Approved by AICTE, Affiliated to JNTUH,Hyd.



81	PAGARTHI SAI KUMAR	CSE	II
82	PAPINENI MANOJ KUMAR	CSE	II
83	PEESU ANUDEEP	CSE	II
84	PININTI RUCHITHA REDDY	CSE	II
85	RIKKA VANDANA	CSE	II
86	SACHIN DAS	CSE	II
87	YADDI SHIVA KUMAR	CSE	II
88	VEMARAJU LASYA MAYURI	CSE	II
89	VIJAYALAXMI	CSE	II
90	BOMMA NITIN	CSE	II
91	MARYALA MANIDEEP	CSE	II
92	BANDI SAI	CSE	II
93	BOPPIDI SRIKAR REDDY	CSE	II
94	GATTU SAIKIRAN	CSE	II
95	J NIKITHA	CSE	II

PRINCIPAL
MAHAVEER
INSTITUTE OF SCIENCE & TECHNOLOGY
Bandlaguda, Hyd-500 005.

Vysapuri, Bandlaguda Post:Keshavgi,
Hyderabad-500 005, TELANGANA INDIA
Tel: 040-64596979,8978380692,
Fax: 040-24455003
E-mail: principal.mahaveer@gmail.com
Website: www.mist.ac.in,

MAHAVEER

Approved by AICTE, Affiliated to JNTUH,Hyd.



37	CH PREMALATHA	ECE	IV
38	SUSHMA	ECE	IV
39	K GURUJOSHI	ECE	IV
40	N JASWANTH	ECE	IV
41	K ABILASH	ECE	IV
42	B PRADEEP KUMAR	ECE	IV
43	CH VARUN REDDY	ECE	IV
44	ARVA SHASHANK	CSE	III
45	BAGGARI SIVA NARAYANA REDDY	CSE	III
46	BEJAVADA KRISHNA SAI	CSE	III
47	BUNNE VAMSHI KRISHNA	CSE	III
48	CHITTIMALLA SAIRAM	CSE	III
49	DIDYALA KIRAN KUMAR	CSE	III
50	NAKKA CHAITANYA	CSE	III
51	GUDURU SANKEERTH	CSE	III
52	GURRAM RAJESH	CSE	III
53	HADDUNOORI SAI KUMAR	CSE	III
54	INDRALA HEMANTH	CSE	III
55	NAGUBANDI SAIRAM PRUDHVI	CSE	III
56	M VARUN KUMAR REDDY	CSE	III
57	GUGULOTH ASHOK	CSE	III
58	NANNURI SHIVA SAI KUMAR REDDY	CSE	III
59	NIMMALA VINAYKUMAR	CSE	III
60	PAYAPULA MAHENDAR	CSE	III
61	POTLA SIDDARTHA	CSE	III
62	SETIKAMSETTI SAI NITISH	CSE	III
63	SHEELAM NIKHIL SAI	CSE	III
64	SURKANTI MAHENDER REDDY	CSE	III
65	BOBBILIGAMA NITHIN KUMAR GOUD	CSE	III
66	KAMBHAM NAVEEN REDDY	CSE	III
67	RAIKODU RAVIKISHOREREDDY	CSE	III
68	UPPUGANDLA SAI KUMAR	CSE	III
69	ANKAM VINEETHA	CSE	II
70	AVULA VAISHNAVI	CSE	II
71	BADAM ABILASH	CSE	II
72	GOLLA NIKHIL KUMAR	CSE	II
73	M NIHARIKA	CSE	II
74	MALGONDA POOJA	CSE	II
75	MALKANNAGARI SRUJAY REDDY	CSE	II
76	MANCHIKANTI SOUMYA	CSE	II
77	MANGILPELLE SAI KUMAR	CSE	II
78	MARIKANTI HARIKA REDDY	CSE	II
79	MD MASTAN	CSE	II
80	NATHI ALEKYA	CSE	II

Kanish
PRINCIPAL
MAHAVEER
INSTITUTE OF SCIENCE & TECHNOLOGY
Bandlaguda, Hyd-500 005.

Vysapuri, Bandlaguda Post:Keshavgirl,
Hyderabad-500 005, TELANGANA INDIA
Tel: 040-64596979,8978380692,
Fax: 040-24455003
E-mail: principal.mahaveer@gmail.com
Website: www.mist.ac.in,

MAHAVEER

Approved by AICTE, Affiliated to JNTUH,Hyd.



Dt: 23/1/2018

EVENT NAME: VIVEKA SUBHASHITAM

Student Participation List

S NO	STUDENT NAME	BRANCH	YEAR
1	L SURENDER REDDY	CIVIL	III
2	D VIJAY	CIVIL	III
3	E TEJASWINI	CIVIL	III
4	N SANTHOSH	CIVIL	III
5	J RAVI	CIVIL	III
6	G PRANAY	CIVIL	III
7	P SRI CHAITANYA	CIVIL	III
8	P PRAVALLIKA	CIVIL	III
9	M RAJITHA	CIVIL	III
10	A DIVISHA	CIVIL	III
11	B SAIJAWAL	CIVIL	III
12	MD ETHESHAN	CIVIL	III
13	MD AHMED	CIVIL	III
14	JEESHAN ASRAF	CIVIL	III
15	MD ANSARI	CIVIL	III
16	V SRAVAN	CIVIL	III
17	G CHARAN	CIVIL	III
18	P RAJESH	CIVIL	III
19	CH OMPRAKASH	CIVIL	IV
20	ANKITH TIWARI	CIVIL	IV
21	SYED KALEEM	CIVIL	IV
22	M KAVYA SREE	ECE	III
23	A JOSNA	ECE	III
24	B ASRITHA	ECE	III
25	R SAI RAM	ECE	III
26	A JAIKRISHNA	ECE	III
27	R SAIKRISHNA	ECE	III
28	MUKUL BHEEM	ECE	III
29	Y LOKESH	ECE	III
30	SHAIK SAIDU	ECE	III
31	SIDDU	ECE	III
32	BHARGHAV	ECE	III
33	CH HARSHITH	ECE	IV
34	A SRIVARSHA	ECE	IV
35	A SHALINI	ECE	IV
36	B SRAVANI	ECE	IV

Kishu
PRINCIPAL
MAHAVEER
INSTITUTE OF SCIENCE & TECHNOLOGY
Bandlaguda, Hyd-500 095

Vysapuri, Bandlaguda Post:Keshavgiri,
Hyderabad-500 005, TELANGANA INDIA
Tel: 040-64596979,8978380692.
Fax: 040-24455003
E-mail: principal.mahaveer@gmail.com,
Website: www.mist.ac.in,

MAHAVEER



Approved by AICTE, Affiliated to JNTUH,Hyd.

Date: 09/2/2018

CIRCULAR

Sub: Enroll the young voters

All the faculty members and students are here by informed that "Enroll the young voters" will be organised by NSS unit of Mahaveer Institute Of Science and Technology in Association is scheduled on 12TH FEBRUARY 2018 between 9.30AM to 2.00PM in our college campus. Students, teaching and non-teaching staff members are requested to participate this event.

Copy to:

All Hod's, Principal
polytechnic, Exam
Branch incharge,
Librarian

PRINCIPAL
MAHAVEER
INSTITUTE OF SCIENCE & TECHNOLOGY
Bandlaguda, Hyd-500 005.

PRINCIPAL

PRINCIPAL
MAHAVEER
INSTITUTE OF SCIENCE & TECHNOLOGY
Bandlaguda, Hyd-500 005.

Vysapuri, Bandlaguda Post:Keshavgi,
Hyderabad-500 005, TELANGANA INDIA
Tel: 040-64596979,8978380692,
Fax: 040-24455003
E-mail: principal.mahaveer@gmail.com
Website: www.mist.ac.in.

MAHAVEER
INSTITUTE OF SCIENCE & TECHNOLOGY
Approved by AICTE, Affiliated to JNTUH,Hyd.



Dt: 12/2/18

Programme 18: Enroll the young voters

The *Chief Electoral Officer & Spl. Secretary to Government, Telangana State* directed the *State NSS Office* to undertake *Massive Awareness programme and Enroll the Young Voters* who attained 18 years and above age in all the junior/ Degree/professional Colleges/Universities on 09/2/2018.

As part of this programme the NSS cell of Mahaveer Institute of Science and Technology conducted this program from 9/2/2018 to 12/2/2018 including **31 students along with their NSS coordinator Dr.M Vasantha Lakshmi** , in this program students took up complete Enrollment of new voters and created awareness among the students of our college , based on the instructions given by DEOs and concerned officials of the Districts by the CEO .



PRINCIPAL

Vysapuri, Bandlaguda Post:Keshavgiri,
Hyderabad-500 005, TELANGANA INDIA
Tel: 040-64596979,8978380692,
Fax: 040-24455003
E-mail: principal.mahaveer@gmail.com
Website: www.mist.ac.in.

MAHAVEER
INSTITUTE OF SCIENCE & TECHNOLOGY
Approved by AICTE, Affiliated to JNTUH,Hyd.



Kshalya
PRINCIPAL
MAHAVEER
INSTITUTE OF SCIENCE & TECHNOLOGY

Vysapuri, Bandlaguda Post:Keshavgiri,
Hyderabad-500 005, TELANGANA INDIA
Tel: 040-64596979,8978380692,
Fax: 040-24455003
E-mail: principal.mahaveer@gmail.com
Website: www.mist.ac.in,

MAHAVEER

Approved by AICTE, Affiliated to JNTUH,Hyd.



Dt: 12/02/2018

EVENT NAME:Enroll the young voters

ORGANIZING COMMITTE

Student organizing members:

S NO	STUDENT NAME	BRANCH	YEAR
1	N CHAITANYA	CSE	III
2	ARVA SHASHANK	CSE	III
3	GUDURU SANKEERTH	CSE	III
4	POTLA SIDDARTHA	CSE	III
5	SETIKAMSETTI SAI NITISH	CSE	III

Faculty organizing members:

S NO	NAME OF THE FACULTY	DESIGNATION	DEPT
1	Dr M VASANTHA LAKSHMI	ASSOCIATE PROFESSOR	CIVIL

PRINCIPAL
MAHAVEER
INSTITUTE OF SCIENCE & TECHNOLOGY
Bandlaguda, Hyd-500 005.

Vysapuri, Bandlaguda Post:Keshavgiri,
Hyderabad-500 005, TELANGANA INDIA
Tel: 040-64596979,8978380692,
Fax: 040-24455003
E-mail: principal.mahaveer@gmail.com
Website: www.mist.ac.in,

MAHAVEER

Approved by AICTE, Affiliated to JNTUH,Hyd.



Dt: 12/02/2018

EVENT NAME: Enroll the young voters

Student Participation List

S NO	STUDENT NAME	BRANCH	YEAR
1	K ABHILASH REDDY	ECE	II
2	Y HARISH	ECE	IV
3	CH HARISH	ECE	II
4	K SRAVAN KUMAR	EEE	IV
5	SAFEED MUFTA HUSSAN	EEE	IV
6	G PRAMITHA	EEE	III
7	G PAVAN KUMAR	ECE	III
8	SRAVAN SUTHAR	MECH	I
9	MD YUSUF KHAN CIVIL	CIVIL	I
10	G NIKHIL REDDY	ECE	II
11	D RAVINDER NAYAK	MECH	III
12	R AMBADAS	EEE	III
13	S SEVYA	MECH	II
14	R ROHITH KUMAR	DEGREE	II
15	K MADHU	EEE	III
16	KPS KOUSHIK	ECE	III
17	MD HASEED QURUSH	EEE	I
18	BHS LAHARI	CSE	III
19	D KJIRAN NAIK	DME	III
20	G SAI KRISHNA	AERO	I
21	N SHIVA SAI KUMAR	CSE	III
22	A RAVI TEJA	ECE	III
23	A VENKATA KRISHNA VAMSHI	ECE	III
24	RAGINIA	ECE	II
25	RAMYASREE	ECE	II
26	SPANDANA	AERO	II
27	ARSHI	CIVIL	III
28	A JANAKI	CIVIL	II
29	B SOHANLAL	CIVIL	II
30	PAVANI	CIVIL	II
31	SAI YASWINI	CIVIL	II

PRINCIPAL
MAHAVEER
INSTITUTE OF SCIENCE & TECHNOLOGY
Bandlaguda, Hyd-500 005.

Vysapuri, Bandlaguda Post:Keshavgiri,
Hyderabad-500 005, TELANGANA INDIA
Tel: 040-64596979,8978380692,
Fax: 040-24455003
E-mail: principal.mahaveer@gmail.com,
Website: www.mist.ac.in,

MAHAVEER

Approved by AICTE, Affiliated to JNTUH,Hyd.



Date: 07/3/2018

CIRCULAR

Sub: Women's day

All the faculty members and students are here by informed that "Women's day" will be organised by NSS unit of Mahaveer Institute Of Science and Technology is scheduled on 08TH MARCH 2018 between 9.30AM to 2.00PM from mist campus shivarampally circle. Students, teaching and non-teaching staff members are requested to participate this event.

Copy to:

All Hod's, Principal
polytechnic, Exam
Branch incharge,
Librarian

PRINCIPAL
MAHAVEER
INSTITUTE OF SCIENCE & TECHNOLOGY
Bandlaguda, Hyd-500 005

PRINCIPAL

PRINCIPAL
MAHAVEER
INSTITUTE OF SCIENCE & TECHNOLOGY
Bandlaguda, Hyd-500 005

Vysapuri, Bandlaguda Post:Keshavgi,
Hyderabad-500 005, TELANGANA INDIA
Tel: 040-64596979,8978380692,
Fax: 040-24455003
E-mail: principal.mahaveer@gmail.com
Website: www.mist.ac.in.

MAHAVEER
INSTITUTE OF SCIENCE & TECHNOLOGY
Approved by AICTE, Affiliated to JNTUH,Hyd.



Dt:8/3/2018

Programmeme 19: Women's day

On the occasion of *International Women's day* celebrations, all the women staff members and girl students of Mahavveer Institute of Science and technology took out a "*Women's Day Rally*" on 8th march 2018 at 10.00am, rally started from *MIST campus to shivarampally circle.*

At the end of the rally faculty and students have gathered in the function hall and police officials have addressed the gathering with regards to procedure to followed in case of atrocities and abuses on women.



PRINCIPAL
MAHAVEER
INSTITUTE OF SCIENCE & TECHNOLOGY

Vysapuri, Bandlaguda Post:Keshavgiri,
Hyderabad-500 005, TELANGANA INDIA
Tel: 040-64596979,8978380692,
Fax: 040-24455003
E-mail: principal.mahaveer@gmail.com
Website: www.mist.ac.in.

MAHAVEER

Approved by AICTE, Affiliated to JNTUH,Hyd.



Dt:14/03/2018

Programmeme 20: State employability skill training programme

This programmeme was organized by *NSS Cell Govt of Telangana & Regional Directorate NSS MOYAS GOL Hyderabad and hosted by NSS cell JNTUH* , for this NSS unit of Mahaveer Institute of Science and Technology depute NSS volunteers (3male and 2 female students) for state employability skill training programmeme this programme was conducted from 15/3/2018 to 17/3/2018 at *CMR Engineering College*.

Five students from different branches of Mahaveer college were participated in this 3 .days residential camp programme and they were trained in skills and how to get employability.

PRINCIPAL
MAHAVEER
INSTITUTE OF SCIENCE & TECHNOLOGY
Bandlaguda, Hyd-500 005.

Vysapuri, Bandlaguda Post:Keshavgiri,
Hyderabad-500 005, TELANGANA INDIA
Tel: 040-64596979,8978380692,
Fax: 040-24455003
E-mail: principal.mahaveer@gmail.com,
Website: www.mist.ac.in,

MAHAVEER



Approved by AICTE, Affiliated to JNTUH,Hyd.

Date: 13/3/2018

CIRCULAR

Sub: State employability skill training programme

All the faculty members and students are here by informed that “**State employability skill training programme**” will be organised by NSS unit of Mahaveer Institute Of Science and Technology in Association with NSS GOVT TELANGANA AND REGIONAL DIRECTORATE NSS MOYASGOL is scheduled on **14TH MARCH 2018** between 9.30AM to 2.00PMat CMR ENGINEERING COLLEGE. Students, teaching and non-teaching staff members are requested to participate this event.

PRINCIPAL

MAHAVEER
INSTITUTE OF SCIENCE & TECHNOLOGY
Bandlaguda, Hyd-500 005.

PRINCIPAL

PRINCIPAL
MAHAVEER
INSTITUTE OF SCIENCE & TECHNOLOGY
Bandlaguda, Hyd-500 005.

Copy to:
All Hod's, Principal
polytechnic, Exam
Branch incharge,
Librarian

Vysapuri, Bandlaguda Post:Keshavgi,
Hyderabad-500 005, TELANGANA INDIA
Tel: 040-64596979,8978380692,
Fax: 040-24455003
E-mail: principal.mahaveer@gmail.com
Website: www.mist.ac.in,

MAHAVEER

Approved by AICTE, Affiliated to JNTUH,Hyd.



Dt: 08/03/2018

EVENT NAME: Women's day

ORGANIZING COMMITTEE

Student organizing members:

S NO	STUDENT NAME	BRANCH	YEAR
1	THOUDE LATHA	CSE	III
2	POLAM RETHIMAREDDY	CSE	III
3	POREDDY NIHARIKA	CSE	III
4	NAGULA SANDHYA RANI	CSE	III

Faculty organizing members:

S NO	NAME OF THE FACULTY	DESIGNATION	DEPT
1	Dr M VASANTHA LAKSHMI	ASSOCIATE PROFESSOR	CIVIL

K. Sankar
PRINCIPAL
MAHAVEER
INSTITUTE OF SCIENCE & TECHNOLOGY
Bandlaguda, Hyd-500 005.

Vysapuri, Bandlaguda Post:Keshavgi,
Hyderabad-500 005, TELANGANA INDIA
Tel: 040-64596979,8978380692,
Fax: 040-24455003
E-mail: principal.mahaveer@gmail.com
Website: www.mist.ac.in,

MAHAVEER

Approved by AICTE, Affiliated to JNTUH,Hyd.



37	MAHESH RATHOD	MECH	I
38	M AKHIL TEJA	MECH	II
39	SAI RAM EDLAM	MECH	II
40	K AKHIL	MECH	II
41	K RAJA SHEKAR REDDY	MECH	II
42	Y VISHNU VARDHAN REDDY	MECH	II
43	K ANUSHA REDDY	MECH	II
44	ISHATH UNNISA BEGUM	MECH	II

PRINCIPAL
MAHAVEER
INSTITUTE OF SCIENCE & TECHNOLOGY
Bandlaguda, Hyd-500 005.

Vysapuri, Bandlaguda Post:Keshavgi,
Hyderabad-500 005, TELANGANA INDIA
Tel: 040-64596979,8978380692,
Fax: 040-24455003
E-mail: principal.mahaveer@gmail.com
Website: www.mist.ac.in,

MAHAVEER

Approved by AICTE, Affiliated to JNTUH,Hyd.



Dt: 08/03/2018

EVENT NAME: Women's day

Student Participation List

S NO	STUDENT NAME	BRANCH	YEAR
1	SHEERIN	ECE	II
2	V SHIVA SHANKAR	ECE	II
3	C VARUN REDDY	ECE	II
4	A SHALINI	ECE	II
5	B SHRAVANI	ECE	II
6	B S AMRUTH VAMSHI	ECE	II
7	K SAI SRI VASTAVA	ECE	II
8	M SAI SUNDER	ECE	II
9	G VARA PRASAD	ECE	II
10	P RAKESH KUMAR	ECE	II
11	CH VEERANAGULU	ECE	II
12	A NARENDRA SAI	ECE	II
13	T NARESH	ECE	II
14	E VAMSHI PRANAY	ECE	II
15	S ABHILASH	ECE	II
16	R CHNDRAKANTH	ECE	II
17	K ANIL KUMAR	ECE	II
18	B VAMSHI KRISHNA	ECE	II
19	SIMALI ROY CHOWDARY	ECE	II
20	K AISHWARYA	ECE	II
21	CH SUSHMITHA	ECE	II
22	MAMATHA	ECE	II
23	RAGANI TIWARI	ECE	II
24	CH HARISH	ECE	II
25	E VARSHITH	ECE	II
26	CH PREMALATHA	ECE	II
27	T PRIYANKA	ECE	II
28	A SAICHITRA	ECE	II
29	K ABHILASH REDDY	ECE	II
30	B PRADEEP	ECE	II
31	N JASHWANTH	ECE	II
32	K SRENU REDDY	MECH	II
33	A SWARAJYAM	MECH	I
34	K SURESH	MECH	I
35	K SURESH	MECH	I
36	MD ASIF	MECH	I

Vysapuri, Bandlaguda Post:Keshavgi,
Hyderabad-500 005, TELANGANA INDIA
Tel: 040-64596979,8978380692,
Fax: 040-24455003
E-mail: principal.mahaveer@gmail.com
Website: www.mist.ac.in,

MAHAVEER



Approved by AICTE, Affiliated to JNTUH,Hyd.

Dt: 14/03/2018

EVENT NAME: State employability skill training programme

Student Participation List

S NO	STUDENT NAME	BRANCH	YEAR
1	SURAJ YADAV	ECE	III
2	N ABHISHEK	ECE	III
3	N SANTOSH	CIVIL	III
4	A NILEEMA	CIVIL	IV
5	KEERTHI MADHURI	CIVIL	III

PRINCIPAL
MAHAVEER
INSTITUTE OF SCIENCE & TECHNOLOGY
Bandlaguda, Hyd-500 005.

Vysapuri, Bandlaguda Post:Keshavgi,
Hyderabad-500 005, TELANGANA INDIA
Tel: 040-64596979,8978380692,
Fax: 040-24455003
E-mail: principal.mahaveer@gmail.com
Website: www.mist.ac.in,

MAHAVEER

Approved by AICTE, Affiliated to JNTUH,Hyd.



INDEX

N.S.S REGULAR ACTIVITIES FOR THE AY 2018-2019

S.NO	EVENT	DATE
1.	Anti plastic and waste management Awareness programme	12/4/18
2.	Donation of Tri-cycle	13/4/18
3.	Interstate youth exchange programme	2/06/2018 to 16/06/18
4.	International yoga day at college	21/06/18
5.	Mera bharat swarnim Bharat	29/06/18
6.	NSS Orientation program	18/07/2018
7.	I year NSS class work	21/07/2018
8.	Rakshbandhan with soliders in artillery center,Mehadipatnam	26/08/18
9.	Swacch Pakwada At College Level	1/09/2018 to 15/09/18
10.	Swacch Pakwada At University Level	16/09/2018
11.	NSS day at Mahaveer Institute of Science and Technology	24/09/2018
12.	Surgical strike day on at Artillery center of Golconda fort Hyderabad	29/09/18
13.	Swacch Bharath	2/10/2018
14.	Haritha haram	03-10-2018
15.	Samskruthi samvad	6/10/2018
16.	AIDS day Awareness	1/12/2018
17.	Volunteering At TS Assembly Elections	7/12/2018
18.	Pushpanjali Program	03/01/2019
19.	Kanti Velugu Program	7/1/2019 to 9/1/2019
20.	Three day youth festival	10/01/19 to 12/01/19
21.	Viveka Subhashitham	23/01/2019
22.	Republic Day celebrations at MIST Campus	26/01/2019
23.	Bharathmatha ki Maha Harathi	26/01/2019
24.	University Level Youth Festival	02/02/2019
25.	Swami Vivekananda and the Relevance of his message in the 21st century	17/02/2019

K. Subh

PRINCIPAL
MAHAVEER
INSTITUTE OF SCIENCE & TECHNOLOGY
Bandlaguda, Hyd-500 005.

Vysapuri, Bandlaguda Post:Keshavgiri,
Hyderabad-500 005, TELANGANA INDIA
Tel: 040-64596979,8978380692.
Fax: 040-24455003
E-mail: principal.mahaveer@gmail.com,
Website: www.mist.ac.in,

MAHAVEER



Approved by AICTE, Affiliated to JNTUH,Hyd.

Date: 10.04.2018

CIRCULAR

Sub: Anti plastic and waste management Awareness programme

All the faculty members and students are here by informed that "Anti plastic and waste management Awareness programme will be organised by NSS unit of Mahaveer Institute Of Science and Technology is scheduled on 12th APRIL 2018 between 9.30AM to 2.00PM near Durganagar college campus. Students, teaching and non-teaching staff members are requested to participate this event.

PRINCIPAL

Copy to:

All Hod's, Principal
polytechnic, Exam
Branch incharge,
Librarian

PRINCIPAL
MAHAVEER
INSTITUTE OF SCIENCE & TECHNOLOGY
Bandlaguda, Hyd-500 005.

1

Vysapuri, Bandlaguda Post:Keshavgi,
Hyderabad-500 005, TELANGANA INDIA
Tel: 040-64596979,8978380692,
Fax: 040-24455003
E-mail: principal.mahaveer@gmail.com
Website: www.mist.ac.in.

MAHAVEER
INSTITUTE OF SCIENCE & TECHNOLOGY
Approved by AICTE, Affiliated to JNTUH,Hyd.



Dt: 12-4-18

Programme 1: Anti plastic and waste management Awareness programme

Almost 500 houses door to door Awareness given on *dry and wet waste segregation, plastic usage in Durganagar and sriramnagar colonies* near by mahaveer college. As part of Swatch Bharath Mission, Some corporate officers participated in this program to motivate the students about Anti plastic and waste management at sports complex katedan. After this students did door to door survey in this GHMC officers Srinivas, china, sharanamma were participated.



K. Srinivas
PRINCIPAL
MAHAVEER
INSTITUTE OF SCIENCE & TECHNOLOGY
Hyderabad, Hvd-500 005.

Vysapuri, Bandlaguda Post:Keshavgi,
Hyderabad-500 005, TELANGANA INDIA
Tel: 040-64596979,8978380692,
Fax: 040-24455003
E-mail: principal.mahaveer@gmail.com
Website: www.mist.ac.in,

MAHAVEER

Approved by AICTE, Affiliated to JNTUH,Hyd.



Dt: 12-04-2018

EVENT NAME: ANTI PLASTIC AND WASTE MANAGEMENT AWARENESS PROGRAMME

Faculty Organizing Committe

S NO	NAME OF THE FACULTY	DESIGNATION	DEPT
1	Dr M Vasanthaxmi	ASSOCIATE PROFERSOR	CIVIL

Keshavgi
PRINCIPAL
MAHAVEER
INSTITUTE OF SCIENCE & TECHNOLOGY
Bandlaguda, Hyd-500 005.

Vysapuri, Bandlaguda Post:Keshavgi,
Hyderabad-500 005, TELANGANA INDIA
Tel: 040-64596979,8978380692,
Fax: 040-24455003
E-mail: principal.mahaveer@gmail.com
Website: www.mist.ac.in,

MAHAVEER

Approved by AICTE, Affiliated to JNTUH,Hyd.



20.	BELUGUPPA H S LAHARI	CSE	III
21.	NAKKA CHAITANYA	CSE	III
22.	GUDURU SANKEERTH	CSE	III
23.	GURRAM RAJESH	CSE	III
24.	KAMPA SRUTEJA	CSE	III
25.	GUGULOTH ASHOK	CSE	III
26.	NIBHANUPUDY CHAITANYA MURALI	CSE	III
27.	PAYAPULA MAHENDAR	CSE	III
28.	POLAM RETHIMAREDDY	CSE	III
29.	B RAKESH	ECE	III

K. S. S.
PRINCIPAL
MAHAVEER
INSTITUTE OF SCIENCE & TECHNOLOGY
Bandlaguda, Hyd-500 005.

Vysapuri, Bandlaguda Post:Keshavgiri,
Hyderabad-500 005, TELANGANA INDIA
Tel: 040-64596979,8978380692,
Fax: 040-24455003
E-mail: principal.mahaveer@gmail.com
Website: www.mist.ac.in,

MAHAVEER



Approved by AICTE, Affiliated to JNTUH,Hyd.

Dt:12-04-2018

EVENT NAME: ANTI PLASTIC AND WASTE MANAGEMENT AWARENESS PROGRAMME

Student Participation List

S NO	STUDENT NAME	BRANCH	YEAR
1.	ASHALA GANESH	ECE	II
2.	ERUGU CHANDU	ECE	II
3.	B NAVYA SRI	ECE	II
4.	ANNABOINA SHALINI	ECE	II
5.	B PRADEEP	ECE	II
6.	BYRA NAGARANI	EEE	II
7.	MANNE SRIDHAR	EEE	II
8.	BADAM ABILASH	CSE	II
9.	MANCHIKANTI SOUMYA	CSE	II
10.	CHOKKARAPU VAISHNAVI	CSE	II
11.	J NIKITHA	CSE	II
12.	AKULA PRANATHI	IT	II
13.	VATTIKUTI MAHESH	IT	II
14.	EEDARA MANOHAR	MECH	II
15.	LUNAVATH GANESH	MECH	II
16.	NALLA TEJASWI	MECH	II
17.	KINAK PAVAN	MECH	II
18.	VALGOTE NIKHIL KUMAR	MECH	II
19.	AMANCHERLA GAYATHRI SUSHMA	CSE	III

K. Srinivas
Principal
MAHAVEER

Vysapuri, Bandlaguda Post:Keshavgiri,
Hyderabad-500 005, TELANGANA INDIA
Tel: 040-64596979,8978380692.
Fax: 040-24455003
E-mail: principal.mahaveer@gmail.com,
Website: www.mist.ac.in,

MAHAVEER



Approved by AICTE, Affiliated to JNTUH,Hyd.

Date: 11.04.2018

CIRCULAR

Sub: Donation of Tri-cycle

All the faculty members and students are here by informed that **"Donation of Tri-cycle programme** will be organised by NSS unit of Mahaveer Institute of Science and Technology is scheduled on **13th APRIL 2018** between 9.30AM to 2.00PM in our college campus. Students, teaching and non-teaching staff members are requested to participate this event.

PRINCIPAL

Copy to:

All Hod's, Principal
polytechnic, Exam
Branch incharge,
Librarian

PRINCIPAL
MAHAVEER
INSTITUTE OF SCIENCE & TECHNOLOGY
Bandlaguda, Hyd-500 005.

Vysapuri, Bandlaguda Post:Keshavgi,
Hyderabad-500 005, TELANGANA INDIA
Tel: 040-64596979,8978380692,
Fax: 040-24455003
E-mail: principal.mahaveer@gmail.com
Website: www.mist.ac.in.

MAHAVEER
INSTITUTE OF SCIENCE & TECHNOLOGY
Approved by AICTE, Affiliated to JNTUH,Hyd.



Dt: 13-4-18

Programme 2: Donation of Tri-cycle

Department of Mechanical Engineering polytechnic students of 2017-18 made tricycle for physically challenged person. It was donated to *Kottapa Swamy Of Suryapet* dist through *NSS UNIT Mahaveer college*.

In this program *Sri.S.Surender Reddy, Secretary of* Mahaveer group of Institutions, *Dr.K.S.S.S.N Reddy* Principal of Mahaveer Institute of Science and Technology , HODs of all the departments and Faculty members of mechanical department were participated.



దివ్యాంగులకు బ్యాసిల్ ట్రై సైకిల్స్ రూపకల్పన



బ్యాసిల్ ట్రై సైకిల్ రూపకల్పన, కార్యాచారణ బహుమతి.

ప్రతివ్యక్తిని దివ్యాంగులకు అనుకూలంగా
బ్యాసిల్ ట్రై సైకిల్స్ తయారీని ప్రోత్సహించి
కార్యాచారణ బహుమతిని కల్పించి
ప్రతివ్యక్తిని దివ్యాంగులకు అనుకూలంగా
బ్యాసిల్ ట్రై సైకిల్స్ తయారీని ప్రోత్సహించి
కార్యాచారణ బహుమతిని కల్పించి

- మొదటి బహుమతి రూ. 4,41,000/-
- 40 మంది బహుమతి
- ప్రతివ్యక్తిని దివ్యాంగులకు అనుకూలంగా

Kanhu
PRINCIPAL
MAHAVEER
INSTITUTE OF SCIENCE & TECHNOLOGY
HYD-500 005.

Vysapuri, Bandlaguda Post:Keshavgiri,
Hyderabad-500 005, TELANGANA INDIA
Tel: 040-64596979,8978380692,
Fax: 040-24455003
E-mail: principal.mahaveer@gmail.com
Website: www.mist.ac.in.

MAHAVEER
INSTITUTE OF SCIENCE & TECHNOLOGY
Approved by AICTE, Affiliated to JNTUH,Hyd.



Kanthy
PRINCIPAL
MAHAVEER
INSTITUTE OF SCIENCE & TECHNOLOGY
Bandlaguda, Hyd-500 005.

Vysapuri, Bandlaguda Post: Keshavgiri,
Hyderabad-500 005, TELANGANA INDIA
Tel: 040-64596979,8978380692,
Fax: 040-24455003
E-mail: principal.mahaveer@gmail.com
Website: www.mlst.ac.in,

MAHAVEER

Approved by AICTE, Affiliated to JNTUH,Hyd.



Dt: 13-4-18

EVENT NAME: DONATION OF TRI-CYCLE

Faculty Organizing Committee

S NO	NAME OF THE FACULTY	DESIGNATION	DEPT
1	Dr M Vasanthaxmi	ASSOCIATE PROFESSOR	CIVIL

K. Sankar

PRINCIPAL
MAHAVEER
INSTITUTE OF SCIENCE & TECHNOLOGY
Bandlaguda, Hyd-500 005.

Vysapuri, Bandlaguda Post:Keshavgi,
Hyderabad-500 005, TELANGANA INDIA
Tel: 040-64596979,8978380692,
Fax: 040-24455003
E-mail: principal.mahaveer@gmail.com
Website: www.mist.ac.in,

MAHAVEER



Approved by AICTE, Affiliated to JNTUH,Hyd.

Dt: 13-4-18

EVENT NAME:DONATION OF TRI-CYCLE

Student Participating Committee

S NO	STUDENT NAME	BRANCH	YEAR
1.	MOHD SALA UDDIN	DMECH	III
2.	NELLURI AJAY KUMAR	DMECH	III
3.	SHADMAN ASHRAF	DMECH	III
4.	PALNATI SRIKANTH REDDY	DMECH	III
5.	SHAIK ABDUL SAIF	DMECH	III
6.	MOHD ABDUL HASEEB	DMECH	III

K. S. S. S.

**PRINCIPAL
MAHAVEER**
INSTITUTE OF SCIENCE & TECHNOLOGY
Bandlaguda, Hyd-500 005.

Vysapuri, Bandlaguda Post: Keshavgi,
Hyderabad-500 005, TELANGANA INDIA
Tel: 040-64596979,8978380692
Fax: 040-24455003
E-mail: principal.mahaveer@gmail.com,
Website: www.mist.ac.in.

MAHAVEER



Approved by AICTE, Affiliated to JNTUH,Hyd.

Dt:01/06/2018

CIRCULAR

Sub: Interstate youth exchange programme

All the faculty members and students are here by informed that “**Interstate youth exchange programme**” will be organised by NSS unit of Mahaveer Institute of Science and Technology in Association with nss cell jntuh is scheduled on 2ND JUNE 2018 – 16TH JUNE 2018 between 9.30AM to 2.00PM in siddhartha institute of engineering and technology. Students, teaching and non-teaching staff members are requested to participate this event.

PRINCIPAL

Copy to:

All Hod's, Principal
polytechnic, Exam
Branch incharge,
Librarian

PRINCIPAL
MAHAVEER
INSTITUTE OF SCIENCE & TECHNOLOGY
Bandlaguda, Hyd-500 005.

Vysapuri, Bandlaguda Post:Keshavgiri,
Hyderabad-500 005, TELANGANA INDIA
Tel: 040-64596979,8978380692,
Fax: 040-24455003
E-mail: principal.mahaveer@gmail.com
Website: www.mist.ac.in.

MAHAVEER
INSTITUTE OF SCIENCE & TECHNOLOGY
Approved by AICTE, Affiliated to JNTUH,Hyd.



Dt:02/06/2018 – 16/06/2018

Programme 3 : Interstate youth exchange programme

This is a Interstate youth exchange programme between telangana and Andhra Pradesh organized by NSS cell JNTUH at Siddhartha Institute of engineering and technology on 02-06-2018 to 16-06-18. Theme of the program was Universal brotherhood, The guests of this program were Saidulu program officer SIET, state NSS officer Dr.Vishnudev garu, Dr . P.Sammulal JNTUH NSS coordinator, Sheethal NSS program officer Shreyas college, Dr.M Vasantha LAKshmi NSS program officer, Dr.S Vijay mohan Rao.



Konky
PRINCIPAL
MAHAVEER
INSTITUTE OF SCIENCE & TECHNOLOGY

Vysapuri, Bandlaguda Post:Keshavgi,
Hyderabad-500 005, TELANGANA INDIA
Tel: 040-64596979,8978380692,
Fax: 040-24455003
E-mail: principal.mahaveer@gmail.com,
Website: www.mist.ac.in,

MAHAVEER



Approved by AICTE, Affiliated to JNTUH,Hyd.

Dt: 19-06-2018

CIRCULAR

Sub: International Yoga day at college

All the faculty members and students are here by informed that “International Yoga day at college” will be organised by NSS unit of Mahaveer Institute of Science and Technology in Association with isha yoga center is scheduled on 21ST JUNE 2018 between 9.30AM to 2.00PM in our college campus. Students, teaching and non-teaching staff members are requested to participate this event.

Copy to:
All Hod's, Principal
polytechnic, Exam
Branch incharge,
Librarian

K. Subh
PRINCIPAL
MAHAVEER
INSTITUTE OF SCIENCE & TECHNOLOGY
Bandlaguda, Hyd-500 005.

K. Subh
PRINCIPAL

Vysapuri, Bandlaguda Post:Keshavgi,
Hyderabad-500 005, TELANGANA INDIA
Tel: 040-64596979,8978380692,
Fax: 040-24455003
E-mail: principal.mahaveer@gmail.com
Website: www.mist.ac.in.

MAHAVEER
INSTITUTE OF SCIENCE & TECHNOLOGY
Approved by AICTE, Affiliated to JNTUH,Hyd.



Dt: 21-06-2018

Programme 4: International Yoga day at college

Every year *International Yoga Day* celebrated in Mahaveer Institute of Science & Technology for students, faculty and their family members. This (2018) programme is conducted with the help of *ISHA YOGA CENTER, Coimbatore, Tamil Nadu Train Teachers Mrs .Girija, Mr.Naraendhar, Mr.Ravi belongs to Hyderabad.*

In this program *Sri.S.Surender Reddy, Secretary of Mahaveer group of Institutions, Dr.K.S.S.S.N Reddy* Principal of Mahaveer Institute of Science and Technology , HODs of all the departments, Teaching, Non teaching Faculty members and all departmental students were participated .

According to the instructions given by Trainers all the participants, practiced Yoga Asanas.



K.S.S.S.N
PRINCIPAL
MAHAVEER
INSTITUTE OF SCIENCE & TECHNOLOGY
HYD-500 005.

Vysapuri, Bandlaguda Post:Keshavgi,
Hyderabad-500 005, TELANGANA INDIA
Tel: 040-64596979,8978380692,
Fax: 040-24455003
E-mail: principal.mahaveer@gmail.com
Website: www.mist.ac.in.

MAHAVEER
INSTITUTE OF SCIENCE & TECHNOLOGY
Approved by AICTE, Affiliated to JNTUH,Hyd.

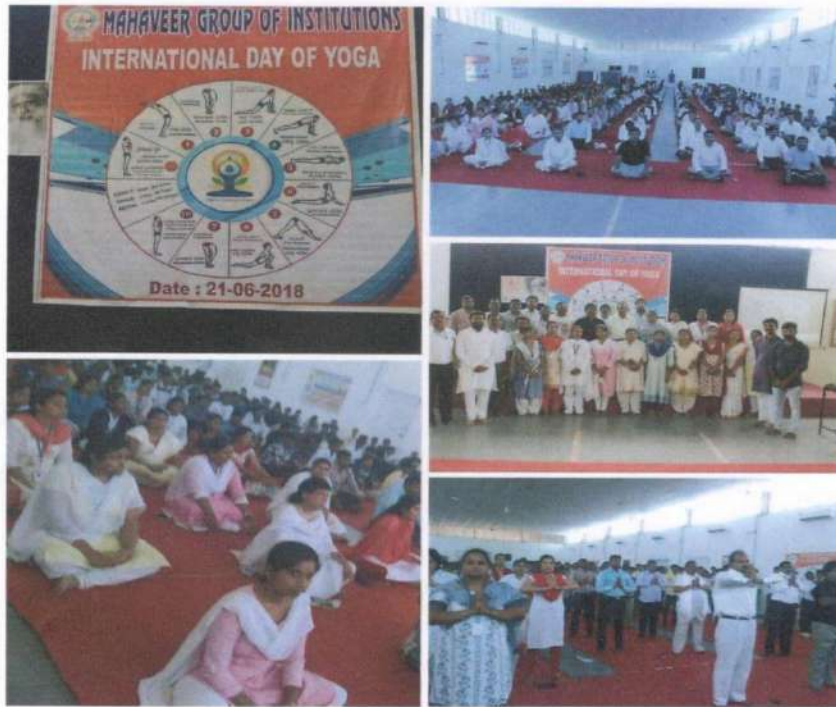

Kanika
PRINCIPAL
MAHAVEER
INSTITUTE OF SCIENCE & TECHNOLOGY
Bandlaguda, Hyd-500 005.

Vysapuri, Bandlaguda Post:Keshavgi,
Hyderabad-500 005, TELANGANA INDIA
Tel: 040-64596979,8978380692,
Fax: 040-24455003
E-mail: principal.mahaveer@gmail.com,
Website: www.mist.ac.in,

MAHAVEER



Approved by AICTE, Affiliated to JNTUH,Hyd.

Dt: 27/06/2018

CIRCULAR

Sub: MERA BHARATH SWARNIM BHARATH

All the faculty members and students are here by informed that “MERA BHARATH SWARNIM BHARATH” will be organised by NSS unit of Mahaveer Institute of Science and Technology is scheduled on 29TH JUNE 2018 between 9.30AM to 2.00PM in our college campus. Students, teaching and non-teaching staff members are requested to participate this event.

PRINCIPAL

Copy to:

All Hod's, Principal
polytechnic, Exam
Branch incharge,
Librarian

PRINCIPAL
MAHAVEER
INSTITUTE OF SCIENCE & TECHNOLOGY
Bandlaguda, Hyd-500 005.

Vysapuri, Bandlaguda Post:Keshavgiri,
Hyderabad-500 005, TELANGANA INDIA
Tel: 040-64596979,8978380692,
Fax: 040-24455003
E-mail: principal.mahaveer@gmail.com,
Website: www.mist.ac.in,

MAHAVEER



Approved by AICTE, Affiliated to JNTUH,Hyd.

Dt: 27/06/2018

CIRCULAR

Sub: MERA BHARATH SWARNIM BHARATH

All the faculty members and students are here by informed that "MERA BHARATH SWARNIM BHARATH" will be organised by NSS unit of Mahaveer Institute of Science and Technology is scheduled on 29TH JUNE 2018 between 9.30AM to 2.00PM in our college campus. Students, teaching and non-teaching staff members are requested to participate this event.

PRINCIPAL

Copy to:

All Hod's, Principal
polytechnic, Exam
Branch incharge,
Librarian

PRINCIPAL
MAHAVEER
INSTITUTE OF SCIENCE & TECHNOLOGY
Bandlaguda, Hyd-500 005.

Vysapuri, Bandlaguda Post:Keshavgi,
Hyderabad-500 005, TELANGANA INDIA
Tel: 040-64596979,8978380692,
Fax: 040-24455003
E-mail: principal.mahaveer@gmail.com
Website: www.mist.ac.in.

MAHAVEER
INSTITUTE OF SCIENCE & TECHNOLOGY
Approved by AICTE, Affiliated to JNTUH,Hyd.



Dt: 29/06/2018

Programme 5: Mera Bharat Swarnim Bharat At Mist Auditorium

This programme was conducted in college campus by **BHRAMMA KUMARI** Hyderabad division. Organized by NSS unit MIST, In this program Dr.K.S.S.S.N Reddy garu principal of mahaveer Institute of science and technology, NSS program officer Dr.M. Vasantha lakshmi garu, all the departmental HOD's and students of All the departments were participated.



K. S. S. S. N
PRINCIPAL
MAHAVEER
INSTITUTE OF SCIENCE & TECHNOLOGY

Vysapuri, Bandlaguda Post:Keshavgiri,
Hyderabad-500 005, TELANGANA INDIA
Tel: 040-64596979,8978380692,
Fax: 040-24455003
E-mail: principal.mahaveer@gmail.com
Website: www.mist.ac.in,

MAHAVEER

Approved by AICTE, Affiliated to JNTUH.Hyd



Dt: 29/06/2018

EVENT NAME: MERA BHARAT SWARNIM BHARAT AT MIST AUDITORIUM

Student Organizing Committee

S NO	STUDENT NAME	BRANCH	YEAR
1.	ANUMALA NAVEENKUMAR	ECE	III
2.	BYREDDY SRIDEVI	ECE	III
3.	POKURI SHEKAR	CIVIL	III
4.	THATIPAMULA RAHUL	MECH	III
5.	JADAV SATHISH	EEE	III
6.	GUDURU SANKEERTH	CSE	IV
7.	NAKKA CHAITANYA	CSE	IV

Faculty Organizing Committee

S NO	NAME OF THE FACULTY	DESIGNATION	DEPT
1	Dr M Vasanthaxmi	ASSOCIATE PROFESSOR	CIVIL

K. S. S.

PRINCIPAL
MAHAVEER
INSTITUTE OF SCIENCE & TECHNOLOGY
Bandlaguda, Hyd-500 005.

Vysapuri, Bandlaguda Post:Keshavgiri,
Hyderabad-500 005, TELANGANA INDIA
Tel: 040-64596979,8978380692.
Fax: 040-24455003
E-mail: principal.mahaveer@gmail.com,
Website: www.mist.ac.in,

MAHAVEER



Approved by AICTE, Affiliated to JNTUH,Hyd.

Dt: 16-07-2018

CIRCULAR

Sub: NSS Orientation program

All the faculty members and students are here by informed that "NSS Orientation program" will be organised by NSS unit of Mahaveer Institute of Science and Technology is scheduled on 18TH JULY 2018 between 9.30AM to 2.00PM in our college campus. Students, teaching and non-teaching staff members are requested to participate this event.

PRINCIPAL

Copy to:

All Hod's, Principal
polytechnic, Exam
Branch incharge,
Librarian

PRINCIPAL
MAHAVEER
INSTITUTE OF SCIENCE & TECHNOLOGY
Bandlaguda, Hyd-500 005.

Vysapuri, Bandlaguda Post:Keshavgi,
Hyderabad-500 005, TELANGANA INDIA
Tel: 040-64596979,8978380692,
Fax: 040-24455003
E-mail: principal_mahaveer@gmail.com
Website: www.mist.ac.in.

MAHAVEER
INSTITUTE OF SCIENCE & TECHNOLOGY
Approved by AICTE, Affiliated to JNTUH,Hyd.



Dt:18-07-2018

Programme 6: NSS Orientation program

This program was conducted for all the departments of *First Year* students to create awareness on *National Service Scheme* and how *NSS was started in INDIA* and what is the importance of NSS logo, every student of NSS has to work out 246hrs of service to the society to get NSS certificate, for this *100 Volunteers* are eligible and they have to participate in activities like Swatch sarvekshan, Rk math programs, university level NSS activities, youth festivals and special camps compulsory.



Mahaveer
PRINCIPAL

Vysapuri, Bandlaguda Post:Keshavgiri,
Hyderabad-500 005, TELANGANA INDIA
Tel: 040-64596979,8978380692.
Fax: 040-24455003
E-mail: principal.mahaveer@gmail.com
Website: www.mist.ac.in.

MAHAVEER

Approved by AICTE, Affiliated to JNTUH,Hyd.



Dt:21/07/2018

Programme 7 : 1 yr NSS Class work

In our Institution we conducted class work for *100 volunteers* who were selected as a *NSS Volunteers* from all the branches, for these students daily 1hr class work were conducted for one branch like that all the branches covered for NSS classes, these classes were conducted by *NSS programme officer Dr.M Vasantha lakshmi* on how they are going to plan to do the works on that week like NSS service Activity plan, motivational songs, Inspiring speeches etc

K. Subh
PRINCIPAL
MAHAVEER
INSTITUTE OF SCIENCE & TECHNOLOGY
Bandlaguda, Hyderabad-500 005.

Vysapuri, Bandlaguda Post:Keshavgiri,
Hyderabad-500 005, TELANGANA INDIA
Tel: 040-64596979,8978380692,
Fax: 040-24455003
E-mail: principal.mahaveer@gmail.com,
Website: www.mist.ac.in,

MAHAVEER



Approved by AICTE, Affiliated to JNTUH,Hyd

DC:19/07/2018

CIRCULAR

Sub: 1 YEAR NSS CLASS WORK

All the faculty members and students are here by informed that "1 YEAR NSS CLASS WORK" will be organised by NSS unit of Mahaveer Institute of Science and Technology is scheduled on **21ST JULY 2018** between 9.30AM to 2.00PM in our college campus. Students, teaching and non-teaching staff members are requested to participate this event.

PRINCIPAL

Copy to:

All Hod's, Principal
polytechnic, Exam
Branch incharge,
Librarian

PRINCIPAL
MAHAVEER
INSTITUTE OF SCIENCE & TECHNOLOGY
Bandlaguda, Hyd-500 005.

Vysapuri, Bandlaguda Post:Keshavgi,
Hyderabad-500 005, TELANGANA INDIA
Tel: 040-64596979,8978380692.
Fax: 040-24455003
E-mail: principal.mahaveer@gmail.com
Website: www.mist.ac.in.

MAHAVEER



Approved by AICTE. Affiliated to JNTUH, Hyd.

Dt:18-07-2018

EVENT NAME:NSS ORIENTATION PROGRAM

Student Organizing Committee

S NO	STUDENT NAME	BRANCH	YEAR
1.	N CHAITANYA	CSE	IV
2.	S MAHENDER REDDY	CSE	IV
3.	G ASHOK	CSE	IV
4.	T LATHA	CSE	IV
5.	G MAHESWARI	CSE	IV
6.	K SRUTEJA	CSE	IV
7.	GURRAM RAJESH	CSE	IV
8.	AFRIN	CSE	IV
9.	POLAM RETHIMAREDDY	CSE	IV

Faculty Organizing Committee

S NO	NAME OF THE FACULTY	DESIGNATION	DEPT
1	Dr M Vasanthaxmi	ASSOCIATE PROFERSOR	CIVIL

K. S. S.
PRINCIPAL
MAHAVEER
INSTITUTE OF SCIENCE & TECHNOLOGY
Bandlaguda, Hyd-500 005.

Vysapuri, Bandlaguda Post:Keshavgi,
Hyderabad-500 005, TELANGANA INDIA
Tel: 040-64596979,8978380692.
Fax: 040-24455003
E-mail: principal.mahaveer@gmail.com,
Website: www.mist.ac.in,

MAHAVEER



Approved by AICTE, Affiliated to JNTUH,Hyd.

Dt: 24-08-18

CIRCULAR

Sub: Rakshbandhan with soliders in artillery center, Mehadipatnam

All the faculty members and students are here by informed that "Rakshbandhan with soliders in artillery center, Mehadipatnam" will be organised by NSS unit of Mahaveer Institute of Science and Technology is scheduled on **26TH AUGUST 2018** between 9.30AM to 2.00PM in mehidipatnam artillery center. Students, teaching and non-teaching staff members are requested to participate this event.

PRINCIPAL

Copy to:

All Hod's, Principal
polytechnic, Exam
Branch incharge,
Librarian

PRINCIPAL
MAHAVEER
INSTITUTE OF SCIENCE & TECHNOLOGY
Bandlaguda, Hyd-500 005.

Vysapuri, Bandlaguda Post:Keshavgi,
Hyderabad-500 005, TELANGANA INDIA
Tel: 040-64596979,8978380692,
Fax: 040-24455003
E-mail: principal.mahaveer@gmail.com
Website: www.mist.ac.in.

MAHAVEER
INSTITUTE OF SCIENCE & TECHNOLOGY
Approved by AICTE, Affiliated to JNTUH,Hyd.



Dt: 26-08-18

**Programme 8 : Rakshbandhan with soliders in artillery center,
Mehadipatnam**

In this program *NSS girls* students were participated to tie the rakhi's to soliders in artillery center mehadipatnam along with NSS program officer *Dr.M Vasanthalakshmi*. Scores of girls tied rakhis to soldiers on the occasion of "*Raksha bandhan*" , the soldiers expressed their views and happiness with those students for celebrating the festival with them.



K. Srinivas
PRINCIPAL
MAHAVEER

Vysapuri, Bandlaguda Post:Keshavgiri,
Hyderabad-500 005, TELANGANA INDIA
Tel: 040-64596979,8978380692,
Fax: 040-24455003
E-mail: principal.mahaveer@gmail.com
Website: www.mist.ac.in.

MAHAVEER

INSTITUTE OF SCIENCE & TECHNOLOGY

Approved by AICTE, Affiliated to JNTUH,Hyd.



Kishu
PRINCIPAL
MAHAVEER
INSTITUTE OF SCIENCE & TECHNOLOGY
Bandlaguda, Hyd-500 005.

Vysapuri, Bandlaguda Post:Keshavgi,
Hyderabad-500 005, TELANGANA INDIA
Tel: 040-64596979,8978380692.
Fax: 040-24455003
E-mail: principal.mahaveer@gmail.com,
Website: www.mist.ac.in,

MAHAVEER

Approved by AICTE. Affiliated to JNTUH.Hyd.



Dt: 30-08-2018

CIRCULAR

Sub: Swacch Pakwada at College Level

All the faculty members and students are here by informed that "Swacch Pakwada At College Level" will be organised by NSS unit of Mahaveer Institute of Science and Technology is scheduled on 1ST SEPTEMBER 18 -15TH SEPTEMBER 18 between 9.30AM to 2.00PM in our college campus. Students, teaching and non-teaching staff members are requested to participate this event.

PRINCIPAL

Copy to:
All Hod's, Principal
polytechnic, Exam
Branch incharge,
Librarian

PRINCIPAL
MAHAVEER
INSTITUTE OF SCIENCE & TECHNOLOGY
Bandlaguda, Hyd-500 005.



Vysap
Hyder
Tel: 04
Fax: 0
E-mai
Webs

Vysapuri, Bandlaguda Post:Keshavgiri,
Hyderabad-500 005, TELANGANA INDIA
Tel: 040-64596979,8978380692,
Fax: 040-24455003
E-mail: principal.mahaveer@gmail.com
Website: www.mist.ac.in,

MAHAVEER

Approved by AICTE, Affiliated to JNTUH,Hyd.



Dt:26-08-2018

**EVENT NAME:RAKSHBANDHAN WITH SOLIDERS IN ARTILLERY
CENTER, MEHADIPATNAM**

Faculty Organizing Committee

S NO	NAME OF THE FACULTY	DESIGNATION	DEPT
1	Dr M Vasanthaxmi	ASSOCIATE PROFERSSOR	CIVIL

Keshav
PRINCIPAL
MAHAVEER
INSTITUTE OF SCIENCE & TECHNOLOGY
Bandlaguda, Hyd-500 005.

Vysapuri, Bandlaguda Post:Keshavgiri,
Hyderabad-500 005, TELANGANA INDIA
Tel: 040-64596979,8978380692,
Fax: 040-24455003
E-mail: principal.mahaveer@gmail.com
Website: www.mist.ac.in,

MAHAVEER

Approved by AICTE, Affiliated to JNTUH,Hyd.



Dt: 26-08-18

EVENT NAME:RAKSHBANDHAN WITH SOLIDERS IN ARTILLERY CENTER, MEHADIPATNAM

Student Participating Committee

S NO	STUDENT NAME	BRANCH	YEAR
1.	M MAMATHA	IT	I
2.	G MAMATHA	IT	I
3.	M POOJA	IT	I
4.	R SATYASRI RUPA	AERO	I
5.	K. RAMYA	CSE	I
6.	N RENU SREE	CSE	I
7.	M AISHWARYA	CSE	I
8.	PADMAVATHI PALIWAL	CSE	I

Keshav
PRINCIPAL
MAHAVEER
INSTITUTE OF SCIENCE & TECHNOLOGY
Bandlaguda, Hyd-500 005.

Vysapuri, Bandlaguda Post:Keshavgiri,
Hyderabad-500 005, TELANGANA INDIA
Tel: 040-64596979,8978380692,
Fax: 040-24455003
E-mail: principal.mahaveer@gmail.com
Website: www.mist.ac.in.

MAHAVEER

Approved by AICTE. Affiliated to JNTUH,Hyd.

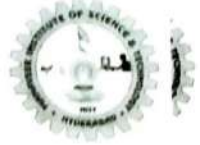

Dt: 1-09-2018 to 15-09-18

Programme 9: Swachh Pakwada At College Level

This program was organized by *NSS cell MIST*, to attain *Swachhta* within and outside the campus, all the departments of Mahaveer students were participated along with the NSS cell coordinator and faculty members, the students gave some *swachhta slogans* also like clean nation – clean us , cleanliness from inside and outside, health automatically will reside both sides, Go clean Go Green etc.

On these days *Best Out Of Waste* program was also conducted, for this students shown their talent and they gave the best things from wastage. The students received certificates from *Sri.S.Sudharshan Reddy chairmen of Mahaveer institute of science and technology on 15/8/2018* for the best events

K. S. Reddy
PRINCIPAL
MAHAVEER
INSTITUTE OF SCIENCE & TECHNOLOGY
Bandlaguda Post, Hyderabad-500 005.

Vysapuri, Bandlaguda Post:Keshavgi,
Hyderabad-500 005, TELANGANA INDIA
Tel: 040-64596979,8978380692,
Fax: 040-24455003
E-mail: principal.mahaveer@gmail.com
Website: www.mist.ac.in.

MAHAVEER

INSTITUTE OF SCIENCE & TECHNOLOGY

Approved by AICTE, Affiliated to JNTUH,Hyd.



Vysapuri, Bandlaguda Post:Keshavgi,
Hyderabad-500 005, TELANGANA INDIA
Tel: 040-64596979,8978380692,
Fax: 040-24455003
E-mail: principal.mahaveer@gmail.com
Website: www.mist.ac.in.

MAHAVEER
INSTITUTE OF SCIENCE & TECHNOLOGY
Approved by AICTE, Affiliated to JNTUH,Hyd.



Khan
PRINCIPAL
MAHAVEER
INSTITUTE OF SCIENCE & TECHNOLOGY
Bandlaguda, Hyd-500 005.

Vysapuri, Bandlaguda Post:Keshavgiri,
Hyderabad-500 005, TELANGANA INDIA
Tel: 040-64596979,8978380692,
Fax: 040-24455003
E-mail: principal.mahaveer@gmail.com,
Website: www.mist.ac.in,

MAHAVEER

Approved by AICTE, Affiliated to JNTUH,Hyd.



Dt:14-09-2018

CIRCULAR

Sub: Swaccha Pakwada at University Level

All the faculty members and students are here by informed that “**Swaccha Pakwada At University Level**” will be organised by NSS unit of Mahaveer Institute of Science and Technology in Association jntuh is scheduled on **16TH SEPTEMBER 2018** between 9.30AM to 2.00PM in JNTUH. Students, teaching and non-teaching staff members are requested to participate this event.

Copy to:

All Hod's, Principal
polytechnic, Exam
Branch incharge,
Librarian

PRINCIPAL
MAHAVEER
INSTITUTE OF SCIENCE & TECHNOLOGY
Bandlaguda, Hyd-500 005.

PRINCIPAL

Vysapuri, Bandlaguda Post Keshavgi,
Hyderabad-500 005, TELANGANA INDIA
Tel: 040-64596979,8978380692.
Fax: 040-24455003
E-mail: principal.mahaveer@gmail.com
Website: www.mist.ac.in,

MAHAVEER

Approved by AICTE, Affiliated to JNTUH,Hyd.



Dt: 1-09-2018 to 15-09-18

Event Name:Swacch Pakwada At College Level

Faculty Organizing Committee

S NO	NAME OF THE FACULTY	DESIGNATION	DEPT
1	Dr M Vasanthalaxmi	ASSOCIATE PROFESSOR	CIVIL

Kanish
PRINCIPAL
MAHAVEER
INSTITUTE OF SCIENCE & TECHNOLOGY
Bandlaguda, Hyd-500 005.

Vysapuri, Bandlaguda Post:Keshavgiri,
Hyderabad-500 005, TELANGANA INDIA
Tel: 040-64596979,8978380692.
Fax: 040-24455003
E-mail: principal.mahaveer@gmail.com
Website: www.mist.ac.in,

MAHAVEER

Approved by AICTE, Affiliated to JNTUH,Hyd.



42	GURRAM MANI RUPAK	CSE	II
43	LONE HARISH	CSE	II

Kshalya

PRINCIPAL
MAHAVEER
INSTITUTE OF SCIENCE & TECHNOLOGY
Bandlaguda, Hyd 500 005.

Vysapuri, Bandlaguda Post:Keshavgiri,
Hyderabad-500 005, TELANGANA INDIA
Tel: 040-64596979,8978380692.
Fax: 040-24455003
E-mail: principal.mahaveer@gmail.com
Website: www.mist.ac.in,

MAHAVEER

Approved by AICTE, Affiliated to JNTUH,Hyd.



19	B PRADEEP	ECE	III
20	NEELA JASHWANTH	ECE	III
21	SURE PRATHYUSHA	ECE	III
22	GUDAPATI VEENA	EEE	III
23	MANNE SRIDHAR	EEE	III
24	BADAM ABILASH	CSE	III
25	PAPINENI MANOJ KUMAR	CSE	III
26	RIKKA VANDANA	CSE	III
27	BANDA MOUNIKA YADAV	ECE	II
28	KONDI AKHILA	ECE	II
29	V RAHUL	ECE	II
30	LOKA SAMHITHA	IT	II
31	PATHA SAIKIRAN	IT	II
32	BADAM RAHUL	EEE	II
33	MALKAGIRI RAKESH	EEE	II
34	BASANOLA JAYVARDHAN	MECH	II
35	G ABHILASH REDDY	MECH	II
36	TEJAVATH LAXMAN	MECH	II
37	DENDE SAI KIRAN	CIVIL	II
38	TURUKA PAVANI	CIVIL	II
39	ADIRE SPANDANA	AERO	II
40	SAMBARU VIKAS	AERO	II
41	GEETHIKA C	CSE	II

Rahul
PRINCIPAL

Vysapuri, Bandlaguda Post:Keshavgirl,
Hyderabad-500 005, TELANGANA INDIA
Tel: 040-64596979,8978380692,
Fax: 040-24455003
E-mail: principal.mahaveer@gmail.com
Website: www.mist.ac.in,

MAHAVEER

Approved by AICTE, Affiliated to JNTUH.Hyd



Dt: 1-09-2018 to 15-09-18

EVENT NAME:SWACCH PAKWADA AT COLLEGE LEVEL

Student Participating Committee

S NO	STUDENT NAME	BRANCH	YEAR
1.	N R SRITEJ	MECH	IV
2.	SINGANABOINA SURESH	MECH	IV
3.	M AJAY	MECH	IV
4.	BANDI PRIYANKA	AERO	IV
5.	LONKA VAMSHI KRISHINA	AERO	IV
6.	PANJAGUTTA PRIYANKA	AERO	IV
7.	BOMMA ABHISHEK	CIVIL	IV
8.	ELISHETTY TEJASWINI	CIVIL	IV
9.	PALLE PRASHANTH KUMAR	CIVIL	IV
10.	DORAGARI NIKHITHA	IT	IV
11.	ARVA SHASHANK	CSE	IV
12.	PAYAPULA MAHENDAR	CSE	IV
13.	POTLA SIDDARTHA	CSE	IV
14.	BANDAPELLI SPOORTHII	ECE	IV
15.	DOSADA SOWMYA	ECE	IV
16.	M RADHIKA	ECE	IV
17.	B NAVYA SRI	ECE	III
18.	ERUGU CHANDU	ECE	III

Kesava

PRINCIPAL

MAHAVEER

Vysapuri, Bandlaguda Post:Keshavgiri,
Hyderabad-500 005, TELANGANA INDIA
Tel: 040-64596979,8978380692,
Fax: 040-24455003
E-mail: principal.mahaveer@gmail.com
Website: www.mist.ac.in.

MAHAVEER



Approved by AICTE. Affiliated to JNTUH,Hyd.

Dt:16-09-2018

Programme 10 : Swaccha Pakwada At University Level

This is a *Swachh Pakhwada Workshop* on 16/9/2018 which includes the topics like Swachh Bharat Abhiyan , cleanliness , waste management , kitchen gardens , segregation of wastage at JNTUH organized by *NSS unit cell JNTUH* , the NSS volunteers of Mahaveer Institute of Science and technology along with their NSS program officer Dr.M vasanthalakshmi were participated after completion of this workshop students were also participated in the swachhta program at JNTU Hyderabad.

K. S. S. S.
Principal
MAHAVEER
INSTITUTE OF SCIENCE & TECHNOLOGY
Bandlaguda, Hyd-500 005.

Vysapuri, Bandlaguda Post:Keshavgiri,
Hyderabad-500 005, TELANGANA INDIA
Tel: 040-64596979,8978380692,
Fax: 040-24455003
E-mail: principal.mahaveer@gmail.com
Website: www.mist.ac.in.

MAHAVEER
INSTITUTE OF SCIENCE & TECHNOLOGY
Approved by AICTE, Affiliated to JNTUH,Hyd.



Kanika
PRINCIPAL
MAHAVEER
INSTITUTE OF SCIENCE & TECHNOLOGY
Bandlaguda, Hyd-500 005.

Vysapuri, Bandlaguda Post:Keshavgiri,
Hyderabad-500 005, TELANGANA INDIA
Tel: 040-64596979,8978380692
Fax: 040-24455003
E-mail: principal.mahaveer@gmail.com
Website: www.mist.ac.in,

MAHAVEER

Approved by AICTE, Affiliated to JNTUH,Hyd



Dt:16-09-18

EVENT NAME:SWACCH PAKWADA AT UNIVERSITY LEVEL

Faculty Organizing Committee

S NO	NAME OF THE FACULTY	DESIGNATION	DEPT
1	Dr M Vasanthaxmi	ASSOCIATE PROFESSOR	CIVIL

K. S. S. S.
PRINCIPAL
MAHAVEER
INSTITUTE OF SCIENCE & TECHNOLOGY
Bandlaguda, Hyd-500 005.

Vysapuri, Bandlaguda Post:Keshavgiri,
Hyderabad-500 005, TELANGANA INDIA
Tel: 040-64596979,8978380692,
Fax: 040-24455003
E-mail: principal.mahaveer@gmail.com
Website: www.mist.ac.in,

MAHAVEER



Approved by AICTE, Affiliated to JNTUHYD

19	PITTALA RAJESH KUMAR	CIVIL	IV
20	Y SAIKIRAN	CIVIL	IV
21	KATPALLY SRENU REDDY	MECH	III
22	KOMMIDI SHRAVAN REDDY	MECH	III
23	V SHIVA KUMAR REDDY	MECH	III
24	BOMMAKANTI SAIKUMAR	MECH	III
25	ANDE NAVEEN KUMAR	IT	III
26	DEVARANENI SANJAY	IT	III
27	PERUMALLA KRANTHI KUMAR	IT	III
28	JADAV SATHISH	EEE	III
29	MUTHINENI VAMSHI	EEE	III
30	K RAHUL	AERO	I
31	P PRUTHVI SHANKAR	AERO	I
32	N DEEPAK	AERO	I
33	E NAVEEN	EEE	I
34	P PREM SAI	CIVIL	I
35	K KARTHEEK	CIVIL	I
36	G VISHWATEJ REDDY	ECE	I
37	P VINEETH KUMAR	ECE	I
38	K KARTHIK	ECE	I
39	R KALYAN SAI	CSE	I
40	M VINAY	CSE	I

K. Srinivas

Principal

Vysapuri, Bandlaguda Post Keshavgi,
Hyderabad-500 005, TELANGANA INDIA
Tel: 040-64596979,8978380692
Fax: 040-24455003
E-mail: principal.mahaveer@gmail.com
Website: www.mist.ac.in,

MAHAVEER

Approved by AICTE, Affiliated to JNTUH Hyd

Dt:16-09-2018

EVENT NAME:SWACCHA PAKWADA AT UNIVERSITY LEVEL

Student Participating Committee

S NO	STUDENT NAME	BRANCH	YEAR
1	N R SRITEJ	MECH	IV
2	M AJAY	MECH	IV
3	BANDI PRIYANKA	AERO	IV
4	LONKA VAMSHI KRISHNA	AERO	IV
5	BOMMA ABHISHEK	CIVIL	IV
6	ELISHETTY TEJASWINI	CIVIL	IV
7	PALLE PRASHANTH KUMAR	CIVIL	IV
8	DORAGARI NIKHITHA	IT	IV
9	BANDAPELLI SPOORTHI	ECE	IV
10	BELUGUPPA H S LAHARI	CSE	IV
11	GOULIKAR SUSHMA	CSE	IV
12	NAKKA CHAITANYA	CSE	IV
13	ARVA SHASHANK	CSE	IV
14	PAYAPULA MAHENDAR	CSE	IV
15	POTLA SIDDARTHA	CSE	IV
16	GUDURU SANKEERTH	CSE	IV
17	GURRAM RAJESH	CSE	IV
18	POLAM RETHIMAREDDY	CSE	IV

K. Srinivas

Principal
MAHAVEER
INSTITUTE OF TECHNOLOGY

Vysapuri, Bandlaguda Post:Keshavgi,
Hyderabad-500 005, TELANGANA INDIA
Tel: 040-64596979,8978380692,
Fax 040-24455003
E-mail: principal.mahaveer@gmail.com,
Website: www.mist.ac.in,

MAHAVEER

Approved by AICTE. Affiliated to JNTUH.Hyd.



Dt: 22-09-2018

CIRCULAR

Sub: NSS day at Mahaveer Institute of Science and Technology

All the faculty members and students are here by informed that "NSS day at Mahaveer Institute of Science and Technology" will be organised by NSS unit of Mahaveer Institute of Science and Technology is scheduled on 24TH SEPTEMBER 2018 between 10.0AM to 2.00PM in our college campus. Students, teaching and non-teaching staff members are requested to participate this event.

PRINCIPAL

Copy to:

All Hod's, Principal
polytechnic, Exam
Branch incharge,
Librarian

PRINCIPAL
MAHAVEER
INSTITUTE OF SCIENCE & TECHNOLOGY
Bandlaguda, Hyd-500 005.

Vysapuri, Bandlaguda Post:Keshavgeri,
Hyderabad-500 005, TELANGANA INDIA
Tel: 040-64596979,8978380692,
Fax: 040-24455003
E-mail: principal_mahaveer@gmail.com
Website: www.mist.ac.in.

MAHAVEER
INSTITUTE OF SCIENCE & TECHNOLOGY
Approved by AICTE, Affiliated to JNTUH,Hyd.



Dt: 24-09-2018

Programme 11 : NSS day at Mahaveer Institute of Science and Technology

NSS day was celebrated at *Mahaveer Institute of Science and Technology* on 24/9/2018. In this event all the NSS unit students were participated and they organized some culture activities like singing dancing, elocution etc. In this program NSS program officer *Dr.M.Vasata laxmi* also participated, after completion of program NSS unit coordinator provided the certificates to the NSS volunteers.



K. Sankar
PRINCIPAL
MAHAVEER
INSTITUTE OF SCIENCE & TECHNOLOGY
HYD-500 005

Vysapuri, Bandlaguda Post:Keshavgiri,
Hyderabad-500 005, TELANGANA INDIA
Tel: 040-64596979,8978380692.
Fax: 040-24455003
E-mail: principal.mahaveer@gmail.com
Website: www.mist.ac.in,

MAHAVEER



Approved by AICTE, Affiliated to JNTUH,Hyd.

Dt:24-09-2018

EVENT NAME:NSS DAY AT MAHAVEER INSTITUTE OF SCIENCE AND TECHNOLOGY

Faculty Organizing Committee

S NO	NAME OF THE FACULTY	DESIGNATION	DEPT
1	Dr M Vasanthaxmi	ASSOCIATE PROFERSOR	CIVIL

PRINCIPAL

MAHAVEER

INSTITUTE OF SCIENCE & TECHNOLOGY

Bandlaguda, Hyd-500 005.

Vysapuri, Bandlaguda Post:Keshavgiri,
Hyderabad-500 005, TELANGANA INDIA
Tel: 040-64596979,8978380692,
Fax: 040-24455003
E-mail: principal.mahaveer@gmail.com
Website: www.mist.ac.in,

MAHAVEER

Approved by AICTE, Affiliated to JNTUH,Hyd



Dt: 24-09-2018

EVENT NAME:NSS DAY AT MAHAVEER INSTITUTE OF SCIENCE AND TECHNOLOGY

Student Participating Committee

S NO	STUDENT NAME	BRANCH	YEAR
1.	BELUGUPPA H S LAHARI	CSE	IV
2.	NAKKA CHAITANYA	CSE	IV
3.	ARVA SHASHANK	CSE	IV
4.	PAYAPULA MAHENDAR	CSE	IV
5.	POTLA SIDDARTHA	CSE	IV
6.	GUDURU SANKEERTH	CSE	IV
7.	GURRAM RAJESH	CSE	IV
8.	POLAM RETHIMAREDDY	CSE	IV
9	N R SRITEJ	MECH	IV
10	M AJAY	MECH	IV
11	BOMMA ABHISHEK	CIVIL	IV
12	ELISHETTY TEJASWINI	CIVIL	IV

PRINCIPAL
MAHAVEER
INSTITUTE OF SCIENCE & TECHNOLOGY
Bandlaguda, Hyd-500 005.

Vysapuri, Bandlaguda Post:Keshavgiri,
Hyderabad-500 005, TELANGANA INDIA
Tel: 040-64596979,8978380692.
Fax: 040-24455003
E-mail: principal.mahaveer@gmail.com,
Website: www.mist.ac.in,

MAHAVEER



Approved by AICTE, Affiliated to JNTUH,Hyd.

Dt:27-09-2018

CIRCULAR

Sub: Surgical strike day on at Artillery center of Golconda Hyderabad

All the faculty members and students are here by informed that **"Surgical strike day on at Artillery center of Golconda fort Hyderabad programme"** will be organised by NSS unit of Mahaveer Institute Of Science and Technology in Association is scheduled on **29TH SEPTEMBER 2018** between 9.30AM to 2.00PM in GOLCONDA FORT HYDERABAD. Students, teaching and non-teaching staff members are requested to participate this event.

Copy to:
All Hod's, Principal
polytechnic, Exam
Branch incharge,
Librarian

PRINCIPAL

PRINCIPAL
MAHAVEER
INSTITUTE OF SCIENCE & TECHNOLOGY
Bandlaguda, Hyd-500 005.

Vysapuri, Bandlaguda Post:Keshavgiri,
Hyderabad-500 005, TELANGANA INDIA
Tel: 040-64596979,8978380692,
Fax: 040-24455003
E-mail: principal.mahaveer@gmail.com
Website: www.mist.ac.in.

MAHAVEER
INSTITUTE OF SCIENCE & TECHNOLOGY
Approved by AICTE, Affiliated to JNTUH,Hyd.



Dt:29-09-18

Programme 12 : Surgical strike day on at Artillery center of Golconda fort Hyderabad

According to the instructions given by UGC to all the NSS Unit cell to participate in this *Surgical Strike Day* which was conducted at *Artillery center of Golkonda fort Hyderabad* on *29/09/2018* keeping in view the national importance of *Parakram Parva*.

On this day NSS volunteers of Mahaveer, nearly 50 NSS volunteers along with NSS program officer *Dr.M Vasantha lakshmi* were participated and pledged their support for the armed force.



K. Sankar
PRINCIPAL
MAHAVEER
INSTITUTE OF SCIENCE & TECHNOLOGY

Vysapuri, Bandlaguda Post:Keshavgi,
Hyderabad-500 005, TELANGANA INDIA
Tel: 040-64596979,8978380692,
Fax: 040-24455003
E-mail: principal.mahaveer@gmail.com
Website: www.mist.ac.in.

MAHAVEER
INSTITUTE OF SCIENCE & TECHNOLOGY
Approved by AICTE, Affiliated to JNTUH,Hyd.



Kishu
PRINCIPAL
MAHAVEER

Vysapuri, Bandlaguda Post:Keshavgi,
Hyderabad-500 005, TELANGANA INDIA
Tel: 040-64596979,8978380692,
Fax: 040-24455003
E-mail: principal.mahaveer@gmail.com,
Website: www.mist.ac.in,

MAHAVEER



Approved by AICTE, Affiliated to JNTUH,Hyd.

Dt: 1/10/2018

CIRCULAR

Sub: Swacch Bharath

All the faculty members and students are here by informed that "Swacch Bharath" will be organised by NSS unit of Mahaveer Institute of Science and Technology in Association SEVA BHARATHI NGO is scheduled on 2ND OCTOBER 2018 between 9.30AM to 2.00PM in MGBS, OSMANIA Hospital. Students, teaching and non-teaching staff members are requested to participate this event.

PRINCIPAL

Copy to:

All Hod's, Principal
polytechnic, Exam
Branch incharge,
Librarian

PRINCIPAL
MAHAVEER
INSTITUTE OF SCIENCE & TECHNOLOGY
HYDERABAD-500 005.

Vysapuri, Bandlaguda Post:Keshavgi,
Hyderabad-500 005, TELANGANA INDIA
Tel: 040-64596979,8978380692.
Fax: 040-24455003
E-mail: principal.mahaveer@gmail.com
Website: www.mist.ac.in,

MAHAVEER

Approved by AICTE, Affiliated to JNTUH,Hyd.



Dt:29-09-2018

**Event Name:Surgical strike day on at Artillery center of Golconda fort
Hyderabad**

Faculty Organizing Committee

S NO	NAME OF THE FACULTY	DESIGNATION	DEPT
1	Dr M Vasanthaxmi	ASSOCIATE PROFERSSOR	CIVIL

Keshavgi
PRINCIPAL
MAHAVEER
INSTITUTE OF SCIENCE & TECHNOLOGY
Bandlaguda, Hyd-500 005.

Vysapuri, Bandlaguda Post: Keshavgi,
Hyderabad-500 005, TELANGANA INDIA
Tel: 040-64596979, 8978380892.
Fax: 040-24455003
E-mail: principal.mahaveer@gmail.com
Website: www.mist.ac.in,

MAHAVEER

Approved by AICTE. Affiliated to JNTUH, Hyd.



42	GURRAM MANI RUPAK	CSE	II
43	LONE HARISH	CSE	II
44	NAKKA CHAITANYA	CSE	IV
45	BELUGUPPA H S LAHARI	CSE	IV
46	GURRAM RAJESH	CSE	IV
47	POLAM RETHIMAREDDY	CSE	IV

PRINCIPAL
MAHAVEER
INSTITUTE OF SCIENCE & TECHNOLOGY

Vysapuri, Bandlaguda Post:Keshavgi,
Hyderabad-500 005, TELANGANA INDIA
Tel: 040-64596979,8978380692,
Fax: 040-24455003
E-mail: principal.mahaveer@gmail.com
Website: www.mist.ac.in,

MAHAVEER

Approved by AICTE, Affiliated to JNTUH.Hyd



19	B PRADEEP	ECE	III
20	NEELA JASHWANTH	ECE	III
21	SURE PRATHYUSHA	ECE	III
22	GUDAPATI VEENA	EEE	III
23	MANNE SRIDHAR	EEE	III
24	BADAM ABILASH	CSE	III
25	PAPINENI MANOJ KUMAR	CSE	III
26	RIKKA VANDANA	CSE	III
27	BANDA MOUNIKA YADAV	ECE	II
28	KONDI AKHILA	ECE	II
29	V RAHUL	ECE	II
30	LOKA SAMHITHA	IT	II
31	PATHA SAIKIRAN	IT	II
32	BADAM RAHUL	EEE	II
33	MALKAGIRI RAKESH	EEE	II
34	BASANOLA JAYVARDHAN	MECH	II
35	G ABHILASH REDDY	MECH	II
36	TEJAVATH LAXMAN	MECH	II
37	DENDE SAI KIRAN	CIVIL	II
38	TURUKA PAVANI	CIVIL	II
39	ADIRE SPANDANA	AERO	II
40	SAMBARU VIKAS	AERO	II
41	GEETHIKA C	CSE	II

K. S. S.
PRINCIPAL

Vysapuri, Bandlaguda Post:Keshavgi,
Hyderabad-500 005, TELANGANA INDIA
Tel: 040-64596979,8978380692.
Fax: 040-24455003
E-mail: principal.mahaveer@gmail.com
Website: www.mist.ac.in,

MAHAVEER

Approved by AICTE. Affiliated to JNTUH,Hyd.



Dt: 29-09-2018

**Event Name:Surgical strike day on at Artillery center of Golconda fort
Hyderabad**

Student Participating Committee

S NO	STUDENT NAME	BRANCH	YEAR
1.	N R SRITEJ	MECH	IV
2.	SINGANABOINA SURESH	MECH	IV
3.	M AJAY	MECH	IV
4.	BANDI PRIYANKA	AERO	IV
5.	LONKA VAMSHI KRISHNA	AERO	IV
6.	PANJAGUTTA PRIYANKA	AERO	IV
7.	BOMMA ABHISHEK	CIVIL	IV
8.	ELISHETTY TEJASWINI	CIVIL	IV
9.	PALLE PRASHANTH KUMAR	CIVIL	IV
10.	DORAGARI NIKHITHA	IT	IV
11.	ARVA SHASHANK	CSE	IV
12.	PAYAPULA MAHENDAR	CSE	IV
13.	POTLA SIDDARTHA	CSE	IV
14.	BANDAPELLI SPOORTHI	ECE	IV
15.	DOSADA SOWMYA	ECE	IV
16.	M RADHIKA	ECE	IV
17.	B NAVYA SRI	ECE	III
18.	ERUGU CHANDU	ECE	III

K. Srinivas
Principal

Vysapuri, Bandlaguda Post:Keshavgi,
Hyderabad-500 005, TELANGANA INDIA
Tel: 040-64596979,8978380692.
Fax: 040-24455003
E-mail: principal.mahaveer@gmail.com
Website: www.mist.ac.in.

MAHAVEER



Approved by AICTE, Affiliated to JNTUH,Hyd.

Dt: 2/10/2018

Programme 13: Swacch Bharath

Swacch bharath arogya bharath program was conducted at MGBS, Osmania General Hospital, Maternity Hospital, Unani Hospital Charminar On the occasion of *Gandhi Jayanthi* on 02-10-2018 with the help of *SEVA BHARATHI NGO*.

In this program 2000 students of Mahaveer Institute of Science and Technology along with all teaching and Non-teaching staff were participated

K. Srinivas
PRINCIPAL
MAHAVEER
INSTITUTE OF SCIENCE & TECHNOLOGY
Bandlaguda, Hyd-500 005.

Vysapuri, Bandlaguda Post:Keshavgi,
Hyderabad-500 005, TELANGANA INDIA
Tel: 040-64596979,8978380692,
Fax: 040-24455003
E-mail: principal.mahaveer@gmail.com
Website: www.mist.ac.in.

MAHAVEER
INSTITUTE OF SCIENCE & TECHNOLOGY
Approved by AICTE, Affiliated to JNTUH,Hyd.



Vysapuri, Bandlaguda Post:Keshavgiri,
Hyderabad-500 005, TELANGANA INDIA
Tel: 040-64596979,8978380692,
Fax: 040-24455003
E-mail: principal.mahaveer@gmail.com
Website: www.mist.ac.in.

MAHAVEER
INSTITUTE OF SCIENCE & TECHNOLOGY
Approved by AICTE, Affiliated to JNTUH,Hyd.



Kishu
PRINCIPAL
MAHAVEER
INSTITUTE OF SCIENCE & TECHNOLOGY

Vysapuri, Bandlaguda Post: Keshavgiri,
Hyderabad-500 005, TELANGANA INDIA
Tel: 040-64596979,8978380692,
Fax: 040-24455003
E-mail: principal.mahaveer@gmail.com
Website: www.mist.ac.in,

MAHAVEER

INSTITUTE OF SCIENCE & TECHNOLOGY
Approved by AICTE, Affiliated to JNTUH, Hyd



Dt:02-10-2018

EVENT NAME:SWACCH BHARATH

Faculty Organizing Committee

S NO	NAME OF THE FACULTY	DESIGNATION	DEPT
1	Dr M Vasanthaxmi	ASSOCIATE PROFERSOR	CIVIL

K. S. S. S.
PRINCIPAL
MAHAVEER
INSTITUTE OF SCIENCE & TECHNOLOGY
Bandlaguda, Hyd-500 005.

Vysapuri, Bandlaguda Post:Keshavgi,
Hyderabad-500 005, TELANGANA INDIA
Tel: 040-64596979,8978380692,
Fax: 040-24455003
E-mail: principal.mahaveer@gmail.com
Website: www.mist.ac.in,

MAHAVEER

Approved by AICTE, Affiliated to JNTUH,Hyd.



Dt: 02-10-2018

EVENT NAME:SWACCH BHARATH

Student Organizing Committee

S NO	STUDENT NAME	BRANCH	YEAR
1	N R SRITEJ	MECH	IV
2	M AJAY	MECH	IV
3	BANDI PRIYANKA	AERO	IV
4	LONKA VAMSHI KRISHNA	AERO	IV
5	BOMMA ABHISHEK	CIVIL	IV
6	ELISHETTY TEJASWINI	CIVIL	IV
7	PALLE PRASHANTH KUMAR	CIVIL	IV
8	DORAGARI NIKHITHA	IT	IV
9	BANDAPELLI SPOORTHI	ECE	IV
10	BELUGUPPA H S LAHARI	CSE	IV
11	GOULIKAR SUSHMA	CSE	IV
12	NAKKA CHAITANYA	CSE	IV
13	ARVA SHASHANK	CSE	IV
14	PAYAPULA MAHENDAR	CSE	IV
15	POTLA SIDDARTHA	CSE	IV
16	GUDURU SANKEERTH	CSE	IV
17	GURRAM RAJESH	CSE	IV
18	POLAM RETHIMAREDDY	CSE	IV

K. Srinivas

PRINCIPAL
MAHAVEER

Vysapuri, Bandlaguda Post:Keshavgi,
Hyderabad-500 005, TELANGANA INDIA
Tel: 040-64596979,8978380692,
Fax: 040-24455003
E-mail: principal.mahaveer@gmail.com,
Website: www.mist.ac.in,

MAHAVEER



Approved by AICTE, Affiliated to JNTUH.Hyd.

Dt: 1/10/2018

CIRCULAR

Sub: HARITHA HARAM

All the faculty members and students are here by informed that "HARITHA HARAM" will be organised by NSS unit of Mahaveer Institute of Science and Technology is scheduled on **3 rd OCTOBER 2018** between 9.30AM to 2.00PM in our college campus. Students, teaching and non-teaching staff members are requested to participate this event.

PRINCIPAL

Copy to:

All Hod's, Principal
polytechnic, Exam
Branch incharge,
Librarian

PRINCIPAL
MAHAVEER
INSTITUTE OF SCIENCE & TECHNOLOGY
Bandlaguda, Hyd-500 005.

Vysapuri, Bandlaguda Post:Keshavgi,
Hyderabad-500 005, TELANGANA INDIA
Tel: 040-64596979,8978380692,
Fax: 040-24455003
E-mail: principal.mahaveer@gmail.com
Website: www.mist.ac.in.

MAHAVEER
INSTITUTE OF SCIENCE & TECHNOLOGY

Approved by AICTE, Affiliated to JNTUH,Hyd.



Dt: 03-10-2018

Programme 14: Haritha haram

This programme was conducted at Mahaveer Institute of science and Technology, Hyderabad on 3/10/2018 organized by *NSS volunteers* MIST along with NSS program officer *Dr.M Vasantha lakshmi*, in this program secretary *Sri.S.Surendar Reddy garu*, *Principal Dr. K.S.S.S.N Readdy garu* and students were participated and they shown very interest for plantation on the college campus for greenery of the college.



K.S.S.S.N
PRINCIPAL
MAHAVEER
INSTITUTE OF SCIENCE & TECHNOLOGY

Vysapuri, Bandlaguda Post Keshavgiri,
Hyderabad-500 005, TELANGANA INDIA
Tel: 040-64596979, 8978380692
Fax: 040-24455003
E-mail: principal_mahaveer@gmail.com
Website: www.mist.ac.in

MAHAVEER



Approved by AICTE, Affiliated to JNTU(H) Hyd

Dt:03-10-2018

EVENT NAME: HARITHA HARAM

Faculty Organizing Committee

S NO	NAME OF THE FACULTY	DESIGNATION	DEPT
1	Dr M Vasanthakumari	ASSOCIATE PROFESSOR	CIVIL

K. S. S. S.
Principal
MAHAVEER INSTITUTE OF TECHNOLOGY
BANDLAGUDA POST, KESHAVGIRI,
HYDERABAD - 500 005, TELANGANA

Vysapuri, Bandlaguda Post:Keshavgiri,
Hyderabad-500 005, TELANGANA INDIA
Tel: 040-64596979,8978380692.
Fax: 040-24455003
E-mail: principal.mahaveer@gmail.com
Website: www.mist.ac.in,

MAHAVEER

Approved by AICTE. Affiliated to JNTUH,Hyd.



19	SADVIKA	CIVIL	1
20	P PREM SAI	CIVIL	1

F. Prasad

PRINCIPAL
MAHAVEER
INSTITUTE OF SCIENCE & TECHNOLOGY
Bandlaguda, Hyd-500 005.

Vysapuri, Bandlaguda Post:Keshavgiri,
Hyderabad-500 005, TELANGANA INDIA
Tel: 040-64596979,8978380692,
Fax: 040-24455003
E-mail: principal.mahaveer@gmail.com
Website: www.mist.ac.in,

MAHAVEER

Approved by AICTE, Affiliated to JNTUH,Hyd.



Dt: 03-10-2018

EVENT NAME: HARITHA HARAM

Student Participating Committee

S NO	NAME OF THE STUDENT	BRANCH	YEAR
1	PADMAVATHI PALIWAL	CSE	I
2	M VINAY	CSE	I
3	M AISHWARYA	CSE	I
4	N RENU SREE	CSE	I
5	K. RAMYA	CSE	I
6	R KALYAN SAI	CSE	I
7	G VISHWATEJ REDDY	ECE	I
8	P VINEETH KUMAR	ECE	I
9	K KARTHIK	ECE	I
10	R SATYASRI RUPA	AERO	I
11	K RAHUL	AERO	I
12	P PRUTHVI SHANKAR	AERO	I
13	N DEEPAK	AERO	I
14	G MAMATHA	IT	I
15	M POOJA	IT	I
16	M MAMATHA	IT	I
17	VAISHALI CHAVAN	EEE	I
18	E NAVEEN	EEE	I

K. Srinivas
PRINCIPAL
MAHAVEER
INSTITUTE OF SCIENCE & TECHNOLOGY
Bandlaguda, Hyd-500 005.

Vysapuri, Bandlaguda Post: Keshavgiri,
Hyderabad-500 005, TELANGANA INDIA
Tel: 040-64596979, 8978380692
Fax: 040-24455003
E-mail: principal.mahaveer@gmail.com,
Website: www.mist.ac.in,

MAHAVEER



Approved by AICTE, Affiliated to JNTU, Hyd.

DC: 4/10/2018

CIRCULAR

Sub: Samskruthi samvad

All the faculty members and students are here by informed that "Samskruthi samvad" will be organised by NSS unit of Mahaveer Institute of Science and Technology in Association with samskruthi foundation is scheduled on **6TH OCTOBER 2018** between 9.30AM to 2.00PM in our college campus. Students, teaching and non-teaching staff members are requested to participate this event.

PRINCIPAL

Copy to:

All Hod's, Principal
polytechnic, Exam
Branch incharge,
Librarian

PRINCIPAL,
MAHAVEER
INSTITUTE OF SCIENCE AND TECHNOLOGY
Bandlaguda, Hyd-500 005.

Vysapuri, Bandlaguda Post:Keshavgi,
Hyderabad-500 005, TELANGANA INDIA
Tel: 040-64596979,8978380692,
Fax: 040-24455003
E-mail: principal.mahaveer@gmail.com
Website: www.mist.ac.in.

MAHAVEER
INSTITUTE OF SCIENCE & TECHNOLOGY
Approved by AICTE, Affiliated to JNTUH,Hyd.



Dt: 6/10/2018

Programme 15: Samskruthi samvad

The Department of H&S and NSS in association with *Samskruti Samvad* by *Samskruti Foundation* conducted a Debate on "*Practicality of Joint Family in current times*" on 6th of October 2018 from 11:00 am to 1:00pm in the main auditorium. The following dignitaries graced the occasion. *Smt.Satyavathi Garu, Executive member & Resource person Mr. Gudla Natraj* Secretary Samskruti Foundation, Mr. Bhoumik Desai Member Samskruti Foundation, Mr.Abhinav Member Samskruti Foundation, Dr.Prathiba HOD (H&S) MIST Dr.Madhusudan Assot.Prof (H&S) MIST. The students participated with great zeal. Participation certificates were given away by the guests.



Keshavgi
PRINCIPAL
MAHAVEER
INSTITUTE OF SCIENCE & TECHNOLOGY
Keshavgi Bandlaguda, Vysapuri, Hyderabad, Telangana 500005.

Vysapuri, Bandlaguda Post:Keshavgiri,
Hyderabad-500 005, TELANGANA INDIA
Tel: 040-64596979,8978380692,
Fax: 040-24455003
E-mail: principal.mahaveer@gmail.com
Website: www.mist.ac.in.

MAHAVEER
INSTITUTE OF SCIENCE & TECHNOLOGY
Approved by AICTE, Affiliated to JNTUH,Hyd.



K. Mahaveer
PRINCIPAL
MAHAVEER
INSTITUTE OF SCIENCE & TECHNOLOGY
HYDARABAD-500 005.

Vysapuri, Bandlaguda Post:Keshavgi,
Hyderabad-500 005, TELANGANA INDIA
Tel: 040-64596979,8978380692.
Fax: 040-24455003
E-mail: principal.mahaveer@gmail.com.
Website: www.mist.ac.in,

MAHAVEER



Approved by AICTE. Affiliated to JNTUH,Hyd.

Dt: 29/11/2018

CIRCULAR

Sub: AIDS day Awareness

All the faculty members and students are here by informed that “AIDS day Awareness” will be organised by NSS unit of Mahaveer Institute of Science and Technology is scheduled on 1st DECEMBER 2018 between 10.00AM to 2.00PM in our college campus. Students, teaching and non-teaching staff members are requested to participate this event.

PRINCIPAL

Copy to:

All Hod's, Principal
polytechnic, Exam
Branch incharge,
Librarian

PRINCIPAL
MAHAVEER
INSTITUTE OF SCIENCE & TECHNOLOGY
Bandlaguda, Hyd-500 005.

Vysapuri, Bandlaguda Post:Keshavgiri,
Hyderabad-500 005, TELANGANA INDIA
Tel: 040-64596979,8978380692,
Fax: 040-24455003
E-mail: principal.mahaveer@gmail.com
Website: www.mist.ac.in,

MAHAVEER

Approved by AICTE, Affiliated to JNTUH,Hyd.



Dt:06-10-2018

EVENT NAME:SAMSKRUTHI SAMVAD

Faculty Organizing Committee

S NO	NAME OF THE FACULTY	DESIGNATION	DEPT
1	Dr M Vasanthaxmi	ASSOCIATE PROFESSOR	CIVIL

K. Subh

PRINCIPAL
MAHAVEER
INSTITUTE OF SCIENCE & TECHNOLOGY
Bandlaguda, Hyd-500 005.

Vysapuri, Bandlaguda Post:Keshavgiri,
Hyderabad-500 005, TELANGANA INDIA
Tel: 040-64596979,8978380692.
Fax: 040-24455003
E-mail: principal.mahaveer@gmail.com
Website: www.mlst.ac.in,

MAHAVEER

Approved by AICTE, Affiliated to JNTUH,Hyd



20	P PREM SAI	CIVIL	1
----	------------	-------	---

K. Srinivas

PRINCIPAL
MAHAVEER
INSTITUTE OF SCIENCE & TECHNOLOGY
Bandlaguda, Hyd 500 005.

Vysapuri, Bandlaguda Post Keshavgiri,
Hyderabad-500 005, TELANGANA INDIA
Tel: 040-64596979, 8978380692
Fax: 040-24455003
E-mail: principal.mahaveer@gmail.com
Website: www.mist.ac.in

MAHAVEER

Approved by AICTE, Affiliated to JNTUH, Hyd



Dt: 06-10-2018

EVENT NAME: SAMSKRUTHI SAMVAD

Student Participating Committee

S NO	NAME OF THE STUDENT	BRANCH	YEAR
1	PADMAYATHI PALIWAL	CSE	I
2	M VINAY	CSE	I
3	M AISHWARYA	CSE	I
4	N RENU SREE	CSE	I
5	K. RAMYA	CSE	I
6	P SWETHA	CSE	I
7	G VISHWATEJ REDDY	ECE	I
8	P VINEETH KUMAR	ECE	I
9	K KARTHIK	ECE	I
10	R SATYASRI RUPA	AERO	I
11	K RAHUL	AERO	I
12	P PRUTHVI SHANKAR	AERO	I
13	N DEEPAK	AERO	I
14	G MAMATHA	IT	I
15	M POOJA	IT	I
16	M MAMATHA	IT	I
17	VAISHALI CHAVAN	EEE	I
18	E NAVEEN	EEE	I
19	SADVIKA	CIVIL	I

K. Srinivas
Principal

Vysapuri, Bandlaguda Post:Keshavgiri,
Hyderabad-500 005, TELANGANA INDIA
Tel: 040-64596979,8978380692.
Fax: 040-24455003
E-mail: principal.mahaveer@gmail.com
Website: www.mist.ac.in.

MAHAVEER

INSTITUTE OF SCIENCE & TECHNOLOGY
Approved by AICTE, Affiliated to JNTUH,Hyd.



Dt: 1/12/2018

Programme 16: AIDS day Awareness

This program was organized at Mahaveer Institute of Science and technology on 1/12/2018 organized by NSS volunteers and program officer. This program was conducted to provide the awareness on HIV prevention, treatment and support activities, like marathon, rally etc. for this so many students participated from different branches of MIST.

K. S. S. S.

PRINCIPAL
MAHAVEER
INSTITUTE OF SCIENCE & TECHNOLOGY
Bandlaguda, Hyd-500 005.

Vysapuri, Bandlaguda Post:Keshavgi,
Hyderabad-500 005, TELANGANA INDIA
Tel: 040-64596979,8978380692,
Fax: 040-24455003
E-mail: principal.mahaveer@gmail.com
Website: www.mist.ac.in.

MAHAVEER
INSTITUTE OF SCIENCE & TECHNOLOGY
Approved by AICTE, Affiliated to JNTUH,Hyd.



Kanika
PRINCIPAL
MAHAVEER

Vysapuri, Bandlaguda Post:Keshavgiri,
Hyderabad-500 005, TELANGANA INDIA
Tel: 040-64596979,8978380692.
Fax: 040-24455003
E-mail: principal.mahaveer@gmail.com
Website: www.mist.ac.in,

MAHAVEER



Approved by AICTE. Affiliated to JNTUH,Hyd

Dt:01-12-2018

EVENT NAME:AIDS DAY AWARENESS

Faculty Organizing Committee

S NO	NAME OF THE FACULTY	DESIGNATION	DEPT
1	Dr M Vasanthaxmi	ASSOCIATE PROFERSOR	CIVIL

K. S. S. S.

MAHAVEER
INSTITUTE OF SCIENCE & TECHNOLOGY
Bandlaguda, Hyd-500 005.

Vysapuri, Bandlaguda Post:Keshavgiri,
Hyderabad-500 005, TELANGANA INDIA
Tel: 040-64596979,8978380692.
Fax: 040-24455003
E-mail: principal.mahaveer@gmail.com
Website: www.mist.ac.in,

MAHAVEER

Approved by AICTE, Affiliated to JNTUH,Hyd.



20	GANDHAM MANOHAR	CIVIL	IV
----	-----------------	-------	----

K. Mahaveer
PRINCIPAL
MAHAVEER
INSTITUTE OF SCIENCE & TECHNOLOGY
Bandlaguda, Hyd-500 005.

Vysapuri, Bandlaguda Post:Keshavgirl,
Hyderabad-500 005, TELANGANA INDIA
Tel: 040-64596979,8978380692,
Fax: 040-24455003
E-mail: principal.mahaveer@gmail.com
Website: www.mlst.ac.in,

MAHAVEER



Approved by AICTE, Affiliated to JNTUH,Hyd.

Dt: 01-12-2018

EVENT NAME:AIDS DAY AWARENESS

Student Participating Committee

S NO	NAME OF THE STUDENT	BRANCH	YEAR
1	NAKKA CHAITANYA	CSE	IV
2	M VINAY	CSE	I
3	VANDANA RIKKA	CSE	III
4	N RENU SREE	CSE	I
5	CHENCHU HARISH	CSE	II
6	GURRAM MANI RUPAK	CSE	II
7	G VISHWATEJ REDDY	ECE	I
8	P VINEETH KUMAR	ECE	I
9	ELLENDULA VARSHITH	ECE	III
10	R SATYASRI RUPA	AERO	I
11	K RAHUL	AERO	I
12	GUGULOTH SAIKRISHNA	AERO	II
13	GANDHAM SHYAMALA	IT	II
14	G MAMATHA	IT	I
15	M POOJA	IT	I
16	GANDHASIRI BHARATH KUMAR	IT	IV
17	VAISHALI CHAVAN	EEE	I
18	E NAVEEN	EEE	I
19	BEGARI DHANRAJ	CIVIL	IV

K. S. S. S.
PRINCIPAL

Vysapuri, Bandlaguda Post:Keshavgi,
Hyderabad-500 005, TELANGANA INDIA
Tel: 040-64596979,8978380692.
Fax: 040-24455003
E-mail: principal.mahaveer@gmail.com,
Website: www.mist.ac.in,

MAHAVEER



Approved by AICTE, Affiliated to JNTUH,Hyd.

Dt: 5/12/2018

CIRCULAR

Sub: Volunteering At TS Assembly Elections

All the faculty members and students are here by informed that “**Volunteering At TS Assembly Elections**” will be organised by NSS unit of Mahaveer Institute of Science and Technology in Association with chief electoral officer election is scheduled on **7TH DECEMBER 2018** between 9.30AM to 2.00PM in our college campus. Students, teaching and non-teaching staff members are requested to participate this event.

Copy to:

All Hod's, Principal
polytechnic, Exam
Branch incharge,
Librarian

PRINCIPAL
MAHAVEER
INSTITUTE OF SCIENCE & TECHNOLOGY
Bandlaguda, Hyd-500 005.

PRINCIPAL

Vysapuri, Bandlaguda Post:Keshavgi,
Hyderabad-500 005, TELANGANA INDIA
Tel: 040-64596979,8978380692,
Fax: 040-24455003
E-mail: principal_mahaveer@gmail.com
Website: www.mist.ac.in.

MAHAVEER
INSTITUTE OF SCIENCE & TECHNOLOGY
Approved by AICTE, Affiliated to JNTUH,Hyd.



Dt: 7/12/2018

Programme 17: Volunteering At TS Assembly Elections

As per the instructions given by *Chief Electoral officer Election*, Election Commission Telangana state, The motto of the election commissions is *No voter to be left behind* has declared 2018 as the *Year of Accessible Election* with the objective to enhance participation of persons with disabilities in the Electoral process for this 40 members of NSS volunteers of Mahaveer Institute of science and technology participated on 7/12/2018 at various polling stations and they helped to disabled persons along with some faculty members.



Principal
PRINCIPAL
MAHAVEER
INSTITUTE OF SCIENCE & TECHNOLOGY

Vysapuri, Bandlaguda Post:Keshavgi,
Hyderabad-500 005, TELANGANA INDIA
Tel: 040-64596979,8978380692.
Fax: 040-24455003
E-mail: principal.mahaveer@gmail.com,
Website: www.mist.ac.in,

MAHAVEER

Approved by AICTE, Affiliated to JNTUH,Hyd.



Dt: 01/01/2019

CIRCULAR

Sub: Pushpanjali Program

All the faculty members and students are here by informed that “**Pushpanjali Program**” will be organised by NSS unit of Mahaveer Institute of Science and Technology is scheduled on 3RD **JANUARY 2019** between 9.30AM to 2.00PM in our college campus. Students, teaching and non-teaching staff members are requested to participate this event.

PRINCIPAL.

Copy to:

All Hod's, Principal
polytechnic, Exam
Branch incharge,
Librarian

PRINCIPAL
MAHAVEER
INSTITUTE OF SCIENCE & TECHNOLOGY
Bandlaguda, Hyd-500 005.

Vysapuri, Bandlaguda Post:Keshavgi,
Hyderabad-500 005, TELANGANA INDIA
Tel: 040-64596979,8978380692.
Fax: 040-24455003
E-mail: principal.mahaveer@gmail.com
Website: www.mist.ac.in,

MAHAVEER



Approved by AICTE Affiliated to JNTUH.Hyd

Dt: 07-12-2018

EVENT NAME:VOLUNTEERING AT TS ASSEMBLY ELECTIONS

Faculty Organizing Committee

S NO	NAME OF THE FACULTY	DESIGNATION	DEPT
1	Dr M Vasanthaxmi	ASSOCIATE PROFERSOR	CIVIL

Kbail

PRINCIPAL
MAHAVEER
INSTITUTE OF SCIENCE & TECHNOLOGY
Bandlaguda Post, Hyderabad-500 005

Vysapuri, Bandlaguda Post:Keshavgi,
Hyderabad-500 005, TELANGANA INDIA
Tel: 040-64596979,8978380692.
Fax: 040-24455003
E-mail: principal.mahaveer@gmail.com
Website: www.mist.ac.in,

MAHAVEER



Approved by AICTE, Affiliated to JNTUH,Hyd.

Dt: 07-12-2018

EVENT NAME:VOLUNTEERING AT TS ASSEMBLY ELECTIONS

Student participating Committee

S NO	STUDENT NAME	BRANCH	YEAR
1	ARVA SHASHANK	CSE	IV
2	BEJAVADA KRISHNA SAI	CSE	IV
3	BELUGUPPA H S LAHARI	CSE	IV
4	GOULIKAR SUSHMA	CSE	IV
5	GUDURU SANKEERTH	CSE	IV
6	GURRAM RAJESH	CSE	IV
7	GUGULOTH ASHOK	CSE	IV
8	NIBHANUPUDY CHAITANYA MURALI	CSE	IV
9	CHIDIRALA RAJKUMAR	MECH	IV
10	KOLLA SAI TEJA	MECH	IV
11	MUDAVATH SRINIVAS	MECH	IV
12	ARUTLA RAJ GOPAL	IT	IV
13	GANDHASIRI BHARATH KUMAR	IT	IV
14	B RAKESH	ECE	IV
15	BONAGIRI SRINIVAS	ECE	IV
16	GUNTI PRAKASH	ECE	IV
17	BOMMIDI NAVEEN	CIVIL	IV
18	GANDHAM MANOHAR	CIVIL	IV

K. S. S.

PRINCIPAL

Vysapuri, Bandlaguda Post:Keshavgiri,
Hyderabad-500 005, TELANGANA INDIA
Tel: 040-64596979,8978380692,
Fax: 040-24455003
E-mail: principal.mahaveer@gmail.com
Website: www.mist.ac.in.

MAHAVEER



Approved by AICTE. Affiliated to JNTUH.Hyd.

Dt: 03/01/2019

Programme 18: Pushpanjali Program

On the occasion of Swami Vivekananda Birth Anniversary Celebrations *Vevekananda Pushpanjali* program was conducted at Mahaveer Institute of science and Technology by NSS unit MIST. For this program *VHEC Director Swami Bodahamayananda* and *TV 5 Chairman Kasa Subba Rao* were invited as a guest of honours. In this program *Sri S. Sudharshan Reddy garu* Chairmen of Mahavaecer group , secretary *Sri.S.Surendar Reddy garu*, *Principal Dr. K.S.S.S.N Readdy garu* , NSS Cordinator Dr.M Vasantha lakshmi Garu and all the Teaching and Non Teaching staff and students of all the departments were participated.

K. S. S. N. Reddy

Principal
MAHAVEER
INSTITUTE OF SCIENCE & TECHNOLOGY
Bandlaguda, Hyd-500 005.

Vysapuri, Bandlaguda Post:Keshavgiri,
Hyderabad-500 005, TELANGANA INDIA
Tel: 040-64596979,8978380692,
Fax: 040-24455003
E-mail: principal.mahaveer@gmail.com
Website: www.mist.ac.in.

MAHAVEER
INSTITUTE OF SCIENCE & TECHNOLOGY
Approved by AICTE, Affiliated to JNTUH,Hyd.



K. Srinivas
PRINCIPAL
MAHAVEER
INSTITUTE OF SCIENCE & TECHNOLOGY

Vysapuri, Bandlaguda Post:Keshavgiri,
Hyderabad-500 005, TELANGANA INDIA
Tel: 040-64596979,8978380692,
Fax: 040-24455003
E-mail: principal.mahaveer@gmail.com
Website: www.mist.ac.in,

MAHAVEER

Approved by AICTE, Affiliated to JNTUH,Hyd.



Dt: 03-01-2019

EVENT NAME:PUSHPANJALI PROGR

Faculty Organizing Committee

S NO	NAME OF THE FACULTY	DESIGNATION	DEPT
1	Dr M Vasanthaxmi	ASSOCIATE PROFERSSOR	CIVIL

PRINCIPAL
MAHAVEER
INSTITUTE OF SCIENCE & TECHNOLOGY
Bandlaguda, Hyd-500 005.

Vysapuri, Bandlaguda Post:Keshavgiri,
Hyderabad-500 005, TELANGANA INDIA
Tel: 040-64596979,8978380692.
Fax: 040-24455003
E-mail: principal.mahaveer@gmail.com
Website: www.mist.ac.in,

MAHAVEER

Approved by AICTE, Affiliated to JNTUH.Hyd



Dt: 03-01-2019

EVENT NAME:PUSHPANJALI PROGRAM

Student Organizing Committee

S NO	NAME OF THE STUDENT	BRANCH	YEAR
1.	KATPALLY SRENU REDDY	MECH	III
2.	KOMMIDI SHRAVAN REDDY	MECH	III
3.	NALLA TEJASWI	MECH	III
4.	ANDE NAVEEN KUMAR	IT	III
5.	DEVARANENI SANJAY	IT	III
6.	KURUVA VAISHNAVI	IT	III
7.	J NIKITHA	CSE	III
8.	GADDAM SAI TEJA REDDY	CSE	III
9.	JAKKULA VAMSHI	CSE	III
10.	ANANTHOJU SHIVANI	ECE	III
11.	ANNAM SRAVAN	ECE	III
12.	CHALLA VARUN REDDY	ECE	III
13.	PETA SAI TEJA	ECE	III

Keshav

PRINCIPAL
MAHAVEER
INSTITUTE OF SCIENCE & TECHNOLOGY
Bandlaguda, Hyd-500 005.

Vysapuri, Bandlaguda Post:Keshavgiri,
Hyderabad-500 005, TELANGANA INDIA
Tel: 040-64596979,8978380692,
Fax: 040-24455003
E-mail: principal.mahaveer@gmail.com,
Website: www.mist.ac.in,

MAHAVEER



Approved by AICTE, Affiliated to JNTUH,Hyd.

Dt: 4/1/2019

CIRCULAR

Sub: Kanti Velugu Program

All the faculty members and students are here by informed that “Kanti Velugu Program” will be organised by NSS unit of Mahaveer Institute of Science and Technology is scheduled on 7TH JANUARY – 9TH JANUARY 2019 between 9.30AM to 2.00PM in our college campus. Students, teaching and non-teaching staff members are requested to participate this event.

PRINCIPAL

Copy to:

All Hod's, Principal
polytechnic, Exam
Branch incharge,
Librarian

PRINCIPAL
MAHAVEER
INSTITUTE OF SCIENCE & TECHNOLOGY
Bandlaguda, Hyd-500 005.

Vysapuri, Bandlaguda Post:Keshavgi,
Hyderabad-500 005, TELANGANA INDIA
Tel: 040-64596979,8978380692,
Fax: 040-24455003
E-mail: principal.mahaveer@gmail.com
Website: www.mist.ac.in.

MAHAVEER



Approved by AICTE. Affiliated to JNTUH,Hyd

Dt: 10-01-19to12-01-19

Programme 20: Three day youth festival

National Youth day celebrations is a *Three Day Youth Festival* program organized at *Vivekananda Institute of Human Excellence*, RK math ,Hyderabad from 10-01-19to12-01-19 for this program 100 *students* of Mahaveer Institute Of Science And Technology along with the *NSS program officer Dr.M Vasantha Lakshmi* were participated and after completion of this program students got the certificates also.

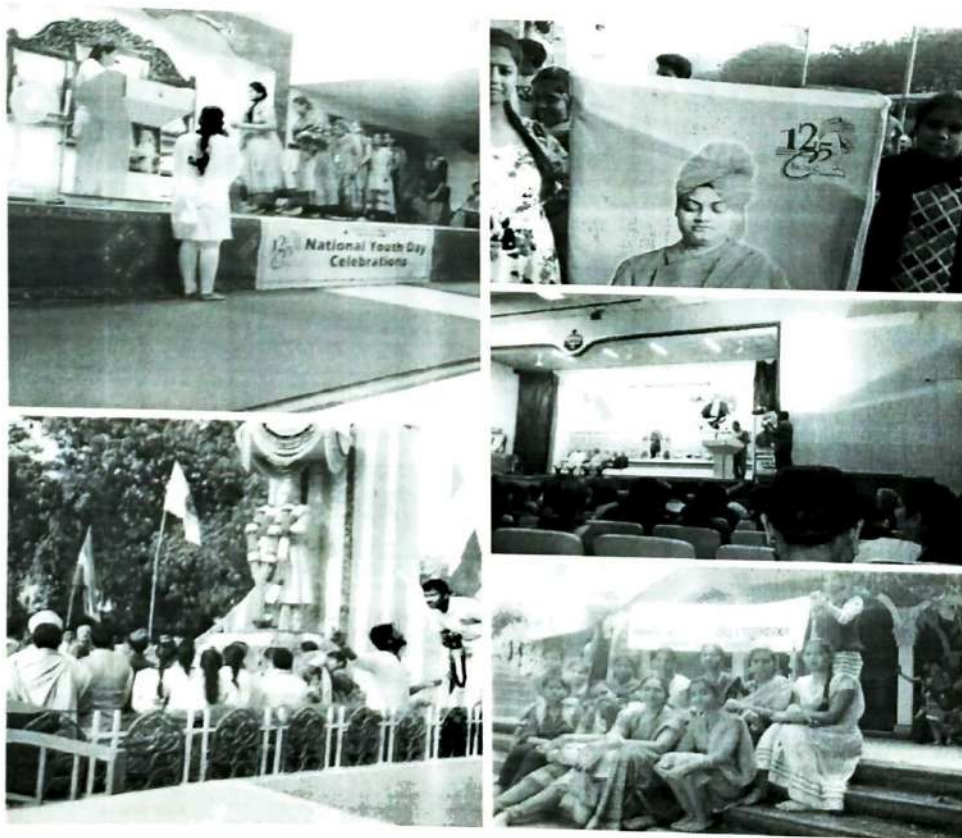

K. S. S. S.
M. S. S. S.
INSTITUTE OF SCIENCE & TECHNOLOGY
Bandlaguda, Hyd-500 005.

Vysapuri, Bandlaguda Post:Keshavgi,
Hyderabad-500 005, TELANGANA INDIA
Tel: 040-64596979,8978380692,
Fax: 040-24455003
E-mail: principal.mahaveer@gmail.com
Website: www.mist.ac.in,

MAHAVEER

Approved by AICTE, Affiliated to JNTUH,Hyd.



Dt: 10-01-19to12-01-19

EVENT NAME:THREE DAY YOUTH FESTIVAL

Faculty Organizing Committee

S NO	NAME OF THE FACULTY	DESIGNATION	DEPT
1	Dr M Vasanthaxmi	ASSOCIATE PROFERSOR	CIVIL

K. S. S. S.

PRINCIPAL
MAHAVEER
INSTITUTE OF SCIENCE & TECHNOLOGY
Bandlaguda, Hyd-500 005.

Vysapuri, Bandlaguda Post:Keshavgiri,
Hyderabad-500 005, TELANGANA INDIA
Tel: 040-64596979,8978380692,
Fax: 040-24455003
E-mail: principal.mahaveer@gmail.com
Website: www.mist.ac.in,

MAHAVEER

Approved by AICTE, Affiliated to JNTUH Hyd



75.	BHOOMIKA	EEE	I
76.	MOHMED ATHER UDDIN	EEE	I
77.	BHARATH KUMAR	DECE	I
78.	SANIYA MUNUAVAR	DECE	I
79.	SAI SHIVANI	DECE	I
80.	B MOUNIKA	DECE	I
81.	SIRI VENNALA	DECE	I
82.	NAVYASRI	DECE	I
83.	PAVITHRA	DECE	I
84.	USHA	DECE	I
85.	HARSHITHA	DECE	I
86.	SOUMYA	DECE	I
87.	AKANKSHA	DECE	I
88.	SATHVIKA	DECE	I
89.	MUJTABA AHMED	MECH	I
90.	ABHILASH CHARY	MECH	I
91.	P UMAMAHESHWAR	DECE	I
92.	P SANJAY	DECE	I
93.	M ADITHYA	DECE	I
94.	N NIKHIL	DECE	I
95.	K NIKHIL	DECE	I
96.	SUMITH	DECE	I
97.	NITHIN	DECE	I
98.	VASU	DECE	I
99.	SRIHARI	DECE	I
100.	D VENKATESH	DECE	I

K. Sankar

MAHAVEER
INSTITUTE OF TECHNOLOGY
Bandlaguda, Hyd-500 005.

Vysapuri, Bandlaguda Post:Keshavgiri,
Hyderabad-500 005, TELANGANA INDIA
Tel: 040-64596979,8978380692,
Fax: 040-24455003
E-mail: principal.mahaveer@gmail.com
Website: www.mist.ac.in,

MAHAVEER



Approved by AICTE, Affiliated to JNTUH Hys

34.	SAI PRIYA	DECE	II
35.	RAMYA SREE	DECE	II
36.	PRANATHI	DEEE	II
37.	R KAVERI	DEEE	I
38.	G LAYA	DEEE	I
39.	J SWATHKA	DEEE	I
40.	V SAI SHIVA	DECE	I
41.	S RISHI KETHAN	DECE	I
42.	B KEERTHANA	DECE	I
43.	V MOUNIKA	DECE	I
44.	B SAI PAVAN	DECE	I
45.	S VINAY KUMAR	DECE	I
46.	Y RAHUL	DECE	I
47.	P SAI JYOTHI	DECE	I
48.	R SAI DURGHA	DECE	I
49.	SOMU VENKAT	DECE	I
50.	NITHIN	DECE	I
51.	D SHRAVANI	DECE	II
52.	V HEMA	DECE	II
53.	C NIDHI SRINIVASA	DECE	II
54.	B DIVYA	DECE	II
55.	Y DEEPIKA	DECE	II
56.	G RAJESH	DECE	I
57.	D VANI	DECE	I
58.	O SATHYA	DEEE	I
59.	L VARSHA TEJ	DECE	I
60.	TEJASHRAVANI	DECE	I
61.	ROOPA	DECE	I
62.	ASHISH	DMECH	II
63.	ANIL	DMECH	II
64.	NIKHIL	DMECH	II
65.	VARSHITHA	DECE	I
66.	BANU	DECE	I
67.	VASANTH	DECE	I
68.	SAI KARTHIK	DECE	I
69.	VEERA GANESH	DECE	I
70.	K ADITHYA	EEE	II
71.	A AKILESH	ECE	II
72.	K BHANU PRAKASH	ECE	II
73.	KUSUMA	EEE	I
74.	AKSHAYA	EEE	I

K. S. S. S.

Vysapuri, Bandlaguda Post:Keshavgiri,
Hyderabad-500 005, TELANGANA INDIA
Tel: 040-64596979,8978380692,
Fax: 040-24455003
E-mail: principal.mahaveer@gmail.com
Website: www.mist.ac.in,

MAHAVEER



Approved by AICTE, Affiliated to JNTUH,Hyd.

Dt: 10-01-19to12-01-19

EVENT NAME:THREE DAY YOUTH FESTIVAL

Student Participating Committee

S NO	NAME OF THE STUDENT	BRANCH	YEAR
1.	K SHIVA SAI	DME	II
2.	K SANDHYA	DCE	I
3.	G KARUNA	DCE	I
4.	K MYTHRI	DCE	I
5.	B SARASWATHI	DCE	I
6.	APARNA	DCE	I
7.	KUSUMA PRIYA	DCE	I
8.	SAMMJUL JOHNSON	DCE	I
9.	P ARUNN KUMAR	DCE	I
10.	M SRI SHIVANI	CSE	I
11.	B SUMA	CSE	I
12.	TANVI BHONSLE	DEEE	I
13.	SHAIID UMAIR AHMED	DEEE	I
14.	MD NAYEEM	DEEE	I
15.	P SHASHIVARDAN	DEEE	I
16.	S YASH RAJ	DEE	I
17.	ARSHITH	DECE	I
18.	G SRI RAM	DECE	I
19.	CH KEERTHI	DECE	I
20.	G VAISHNAVI	DECE	I
21.	B JOHSNA	DECE	I
22.	K MANOJ KUMAR	DECE	I
23.	B VENKATA CHARY	DECE	I
24.	CH VENKATALAXMINARASIMHA RAO	AERO	I
25.	T RADHIKA	AERO	I
26.	S NAGALXMI	AERO	I
27.	B DIVYA	MECH	I
28.	M PRATHIBHA	AERO	I
29.	S OMAIR AHMED	MECH	III
30.	I SAI GANESH	MECH	II
31.	N ADITHYA	DCE	I
32.	VAISHANI DEVI	DCE	I
33.	SHARANYA	DECE	I

Keshavi

Vysapuri, Bandlaguda Post:Keshavgi,
Hyderabad-500 005, TELANGANA INDIA
Tel: 040-64596979,8978380692,
Fax: 040-24455003
E-mail: principal.mahaveer@gmail.com,
Website: www.mist.ac.in,

MAHAVEER



Approved by AICTE, Affiliated to JNTUH,Hyd.

Dt: 21/01/2019

CIRCULAR

Sub: Viveka Subhashitham

All the faculty members and students are here by informed that “Viveka Subhashitham” will be organised by NSS unit of Mahaveer Institute of Science and Technology in Association samskruthi foundation is scheduled on 23RD JANUARY 2019 between 9.30AM to 2.00PM at RK MATH AUDITORIUM . Students, teaching and non-teaching staff members are requested to participate this event.

Copy to:

All Hod's, Principal
polytechnic, Exam
Branch incharge,
Librarian

PRINCIPAL

PRINCIPAL
MAHAVEER
INSTITUTE OF SCIENCE & TECHNOLOGY
Bandlaguda, Hyd-500 005.

Vysapuri, Bandlaguda Post:Keshavgi,
Hyderabad-500 005, TELANGANA INDIA
Tel: 040-64596979,8978380692
Fax: 040-24455003
E-mail: principal.mahaveer@gmail.com
Website: www.mist.ac.in.

MAHAVEER



Approved by AICTE, Affiliated to JNTUH,Hyd

Dt: 23/01/2019

Programme 21: Viveka Subhashitham

Viveka subhashitham programme *Be Good Do Good* programme was organized by *Samskruthi foundation* on 23-01-2019 at *RK math auditorium*. On the occasion of *Subhash chandrabose jayanthi*, for this program our college NSS Voluntaries with their coordinator were participated and students got certificates also. Speakers of the day *Dr.C. Uma maheshwar Rao* *chairmen retired IAS officer, Dr.Vivek Modi and Sri Bhodhamayananda garu.*

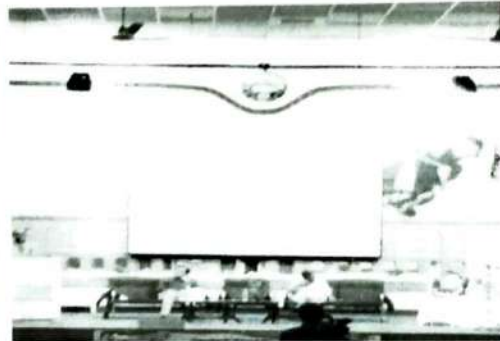

K. Srinivas

Principal,
MAHAVEER INSTITUTE OF TECHNOLOGY & MANAGEMENT
Bandlaguda, Hyd-500 005.

Vysapuri, Bandlaguda Post:Keshavgiri,
Hyderabad-500 005, TELANGANA INDIA
Tel: 040-64596979,8978380692,
Fax: 040-24455003
E-mail: principal.mahaveer@gmail.com
Website: www.mist.ac.in,

MAHAVEER

Approved by AICTE, Affiliated to JNTUH,Hyd.



Dt:23/1/2019

EVENT NAME:VIVEKA SUBHASHITHAM

Faculty Organizing Committee

S NO	NAME OF THE FACULTY	DESIGNATION	DEPT
1	Dr M Vasanthaxmi	ASSOCIATE PROFESSOR	CIVIL

K. S. R.

PRINCIPAL
MAHAVEER
INSTITUTE OF TECHNOLOGY
Bandlaguda, Hyd-500 005.

Vysapuri, Bandlaguda Post Keshavgiri,
Hyderabad-500 005, TELANGANA INDIA
Tel: 040-64596979,8978380692,
Fax: 040-24455003
E-mail: principal.mahaveer@gmail.com
Website: www.mist.ac.in,

MAHAVEER



Approved by AICTE. Affiliated to JNTUH Hyd

66.	H SANTHOSH	ECE	I
67.	P ANIRUDH	ECE	I
68.	GAYATRI	ECE	I
69.	Y PAVAN	ECE	I
70.	K SAI PRASANNA	ECE	I
71.	N SHIVA JYOTHI	ECE	I
72.	B SWAPNA	ECE	I
73.	K ASRITHA	ECE	I
74.	R HARITHA	ECE	I
75.	J KAVERI	ECE	I
76.	P SHIVAJYOTHI	ECE	I
77.	NEHA JABEEN	ECE	I
78.	CHANDANA	ECE	I
79.	M MUKUNDINI	ECE	I
80.	BHARATH	CIVIL	I

K. S. S.

PRINCIPAL
MAHAVEER
INSTITUTE OF SCIENCE & TECHNOLOGY
Bandlaguda, Hyd-500 005.

Vysapuri, Bandlaguda Post:Keshavgiri,
Hyderabad-500 005, TELANGANA INDIA
Tel: 040-64596979,8978380692.
Fax: 040-24455003
E-mail: principal.mahaveer@gmail.com
Website: www.mist.ac.in,

MAHAVEER



Approved by AICTE, Affiliated to JNTU(H) Hyd

43.	P PREM SAI	CIVIL.	I
44.	R CHARAN	CIVIL.	I
45.	R BALARAJ	CIVIL.	I
46.	R SHANKAR	CIVIL.	I
47.	R NIKHL	CIVIL.	I
48.	RAYAN	CIVIL.	I
49.	R BHARATH	CIVIL.	I
50.	BHEEM REDDY	CIVIL.	I
51.	S AKASH	CIVIL.	I
52.	FAISAL	CIVIL.	I
53.	M BHANU TEJA	ECE	I
54.	ABHINAV MOHANTH	ECE	I
55.	P SHIVA PRASAD	ECE	I
56.	CH PRANAY RAJ	ECE	I
57.	K PRANY	ECE	I
58.	A LOUSHIK	ECE	I
59.	G VISHWATEJA REDDY	ECE	I
60.	R HARISH KUMAR	ECE	I
61.	V ABHINAV	ECE	I
62.	B TEJA	ECE	I
63.	G HARSHITH	ECE	I
64.	G SANDDEP KUMAR	ECE	I
65.	B NAVEENKUMAR	ECE	I

Vysapuri, Bandlaguda Post: Keshavgiri,
Hyderabad-500 005, TELANGANA INDIA
Tel: 040-64596979,8978380692,
Fax: 040-24455003
E-mail: principal.mahaveer@gmail.com
Website: www.mist.ac.in,

MAHAVEER

Approved by AICTE, Affiliated to JNTUH, Hyd



20.	MA QUAREEZ AID	ECE	1
21.	A SHRAVAN	IT	1
22.	P SHIVA PRASAD	ECE	1
23.	K MAHESHBABU	ECE	1
24.	H PAVAN KUMAR	ECE	1
25.	Q RAJASHEKAR	ECE	1
26.	G NAGA RAJ	ECE	1
27.	A SRILEKHA	CIVIL	1
28.	B ANIL NAIK	CIVIL	1
29.	CH SANJEEV	CIVIL	1
30.	CHANDRAVARDHAN	CIVIL	1
31.	D JAYA SIMHA	CIVIL	1
32.	D KALYAN	CIVIL	1
33.	D TARUN KUMAR	CIVIL	1
34.	D YUVA KUMAR	CIVIL	1
35.	G HARSHA VARDHAN	CIVIL	1
36.	G VEENEETH	CIVIL	1
37.	K MANEESH	CIVIL	1
38.	K REAVANTH REDDY	CIVIL	1
39.	MD NADEEM	CIVIL	1
40.	MA WAJAHATH	CIVIL	1
41.	ATIF	CIVIL	1
42.	N NAVVEN RAM	CIVIL	1

K. Srinivas

Vysapuri, Bandlaguda Post:Keshavgiri,
Hyderabad-500 005, TELANGANA INDIA
Tel: 040-64596979,8978380692.
Fax: 040-24455003
E-mail: principal.mahaveer@gmail.com
Website: www.mist.ac.in,

MAHAVEER

Approved by AICTE, Affiliated to JNTUH,Hyd



Dt:23/1/2019

EVENT NAME:VIVEKA SUBHASHITHAM

Student Participating Committee

S NO	NAME OF THE STUDENT	BRANCH	YEAR
1.	G MAMATHA	IT	1
2.	M MAMATHA	IT	1
3.	AFRAH MOHAMMED	IT	1
4.	CHNDANA YADAV	EEE	1
5.	MUSKAN PRIYA	EEE	1
6.	P KEERTHI	EEE	1
7.	M AKANKSHA	EEE	1
8.	K HANILA	EEE	1
9.	MIR JAKEER UDDIN	IT	1
10.	S MUSTAU AHMED	EEE	1
11.	SOHAIL F SHAREEF	IT	1
12.	MD JAHEED HUSSAIN	IT	1
13.	P PUSHPALATHA	IT	1
14.	M POOJA	IT	1
15.	KIRAN KUMARI	IT	1
16.	A ABHISHEK	IT	1
17.	D ANUJ	IT	1
18.	B RAGHAVENDRA	IT	1
19.	H JEEVAN	EEE	1

K. Srinivas

Vysapuri, Bandlaguda Post, Keshavgiri,
Hyderabad-500 005, TELANGANA INDIA
Tel: 040-64596979,8978380692
Fax: 040-24455003
E-mail: principal.mahaveer@gmail.com,
Website: www.mist.ac.in,

MAHAVEER



Approved by AICTE, Affiliated to JNTUH, Hyd.

Dt: 25/01/2019

CIRCULAR

Sub: Republic Day celebrations at MIST Campus

All the faculty members and students are hereby informed that “**Republic Day celebrations at MIST Campus**” will be organised by NSS unit of Mahaveer Institute of Science and Technology is scheduled on **26TH JANUARY 2019** between 9.30AM to 2.00PM in our college campus. Students, teaching and non-teaching staff members are requested to participate this event.

PRINCIPAL

Copy to:

All Hod's, Principal
polytechnic, Exam
Branch incharge,
Librarian

PRINCIPAL
MAHAVEER
INSTITUTE OF SCIENCE & TECHNOLOGY
Bandlaguda, Hyd-500 005.

Vysapuri, Bandlaguda Post Keshavnagar,
Hyderabad-500 005, TEL ANGANA INDIA
Tel: 040-64596979,8978380992
Fax: 040-24455003
E-mail: principal.mahaveer@gmail.com
Website: www.mist.ac.in.

MAHAVEER



Approved by AICTE. Affiliated to JNTU-Hydr.

Dt: 26/01/2019

Programme 22: Republic Day celebrations at MIST Campus

On the occasion of *Republic day celebrations at MIST college campus*, NSS Volunteers did the *NSS parade* in the college campus for this all the NSS volunteers were participated and appreciated by the College management and after that flag hosting done by chairmen Sri S.Sudharshan Reddy garu, secretary Sri S.Surendar reddy garu, principal Dr.K.S.S.N Reddy garu for this all the faculty members and Students were participated after that Other culture activities had been conducted and certificates also distributed to the students.



Khandu

Principal
Mahaveer Group of Institutions
Bandlaguda, -Hy-500 005.

Vysapuri, Bandlaguda Post:Keshavgiri,
Hyderabad-500 005, TELANGANA INDIA
Tel: 040-64596979,8978380692,
Fax: 040-24455003
E-mail: principal.mahaveer@gmail.com,
Website: www.mist.ac.in,

MAHAVEER



Approved by AICTE. Affiliated to JNTUH.Hyd.

Dt:24-01-2019

CIRCULAR

Sub: Bharathmatha ki Maha Harathi

All the faculty members and students are here by informed that “**Bharathmatha ki Maha Harathi** will be organised by NSS unit of Mahaveer Institute of Science and Technology in Association with bharatha matha foundation scheduled on 26TH JANUARY 2019 between 9.30AM to 2.00PM peoples plaza hyderabad. Students, teaching and non-teaching staff members are requested to participate this event.

Copy to:

All Hod's, Principal
polytechnic, Exam
Branch incharge,
Librarian

PRINCIPAL

PRINCIPAL
MAHAVEER
INSTITUTE OF SCIENCE & TECHNOLOGY
Bandlaguda, Hyd-500 005.

Vysapuri, Bandlaguda Post:Keshavgiri,
Hyderabad-500 005, TELANGANA INDIA
Tel: 040-64596979,8978380692,
Fax: 040-24455003
E-mail: principal.mahaveer@gmail.com
Website: www.mist.ac.in,

MAHAVEER



Approved by AICTE, Affiliated to JNTUH,Hyd

Dt:26/1/2019

EVENT NAME:REPUBLIC DAY CELEBRATIONS AT MIST CAMPUS

Faculty Organizing Committee

S NO	NAME OF THE FACULTY	DESIGNATION	DEPT
1	Dr M Vasanthaxmi	ASSOCIATE PROFERSOR	CIVIL

K. S. S. S.
Principal
MAHAVEER
INSTITUTE OF SCIENCE & TECHNOLOGY
Bandlaguda, Hyd-500 005.

Vysapuri, Bandlaguda Post Keshavgiri,
Hyderabad-500 005, TELANGANA INDIA
Tel: 040-64596979,8978380692.
Fax: 040-24455003
E-mail: principal.mahaveer@gmail.com
Website: www.mist.ac.in,

MAHAVEER

Approved by AICTE, Affiliated to JNTUH Hyd.



43	LONE HARISH	CSE	II
----	-------------	-----	----

K. S. S. S.

M. S. S. S.
INSTITUTE OF SCIENCE & TECHNOLOGY
Bandlaguda, Hyd-500 005.

Vysapuri, Bandlaguda Post:Keshavgi,
Hyderabad-500 005, TELANGANA INDIA
Tel: 040-64596979,8978380692,
Fax: 040-24455003
E-mail: principal.mahaveer@gmail.com
Website: www.mist.ac.in,

MAHAVEER

Approved by AICTE, Affiliated to JNTUH, Hyd.



20	NEELA JASHWANTH	ECE	III
21	SURE PRATHYUSHA	ECE	III
22	GUDAPATI VEENA	EEE	III
23	MANNE SRIDHAR	EEE	III
24	BADAM ABILASH	CSE	III
25	PAPINENI MANOJ KUMAR	CSE	III
26	RIKKA VANDANA	CSE	III
27	BANDA MOUNIKA YADAV	ECE	II
28	KONDI AKHILA	ECE	II
29	V RAHUL	ECE	II
30	LOKA SAMHITHA	IT	II
31	PATHA SAIKIRAN	IT	II
32	BADAM RAHUL	EEE	II
33	MALKAGIRI RAKESH	EEE	II
34	BASANOLA JAYVARDHAN	MECH	II
35	G ABHILASH REDDY	MECH	II
36	TEJAVATH LAXMAN	MECH	II
37	DENDE SAI KIRAN	CIVIL	II
38	TURUKA PAVANI	CIVIL	II
39	ADIRE SPANDANA	AERO	II
40	SAMBARU VIKAS	AERO	II
41	GEETHIKA C	CSE	II
42	GURRAM MANI RUPAK	CSE	II

K. Srinivas

PT

M

Vysapuri, Bandlaguda Post Keshavnagar,
Hyderabad 500 095, TELANGANA INDIA
Tel: 040-64596979,8978380692
Fax: 040-24455003
E-mail: principal.mahaveer@gmail.com
Website: www.mist.ac.in,

MAHAVEER



Approved by AICTE Affiliated to JNTU-Hydr

Dt:26/1/2019

EVENT NAME:REPUBLIC DAY CELEBRATIONS AT MIST CAMPUS

Student Participating Committee

S NO	STUDENT NAME	BRANCH	YEAR
1.	N.R.SRIJEI	MECH	IV
2.	SINGANABOINA SURESH	MECH	IV
3.	M AJAY	MECH	IV
4.	BANDI PRIYANKA	AERO	IV
5.	LONKA VAMSHI KRISHNA	AERO	IV
6.	PANJAGUTTA PRIYANKA	AERO	IV
7.	BOMMA ABHISHEK	CIVIL	IV
8.	ELISHETTY TEJASWINI	CIVIL	IV
9.	PALLE PRASHANTH KUMAR	CIVIL	IV
10.	DORAGARI NIKHITHA	IT	IV
11.	ARVA SHASHANK	CSE	IV
12.	PAYAPULA MAHENDAR	CSE	IV
13.	POTLA SIDDARTHA	CSE	IV
14.	BANDAPELLI SPOORTHI	ECE	IV
15.	DOSADA SOWMYA	ECE	IV
16.	M RADHIKA	ECE	IV
17.	B NAVYA SRI	ECE	III
18.	ERUGU CHANDU	ECE	III
19.	B PRADEEP	ECE	III

K. Srinivas

Vysapuri, Bandlaguda Post:Keshavgiri,
Hyderabad-500 005, TELANGANA INDIA
Tel: 040-64596979,8978380692.
Fax: 040-24455003
E-mail: principal.mahaveer@gmail.com
Website: www.mist.ac.in.

MAHAVEER

INSTITUTE OF SCIENCE & TECHNOLOGY
Approved by AICTE. Affiliated to JNTUH,Hyd.



Dt:26-01-2019

Programme 23: Bharathmatha ki Maha Harathi

This program was organized by *Bharath matha Foundation*, at peoples plaza Hyderabad at 5.00pm, chief guest of this program is *Sri Chaganti Koteswara Rao Garu* and *Sri G.Kishan Reddy garu founder of Bharath Mata Foundation*, To Celebrate the Spirit Of Patriotism At The Maha Harathi and tribute to the nation on the occasion of republic day. 1000's of people were participated in this event. The main motto of this event is for *Gnnis world record* by this India had created a new record with 1000 girls dressed in the attire of Bharatha Mata while presenting the *Tiranga Theme*. On this special event our college students were also participated.

K. S. S. S.

PRINCIPAL
MAHAVEER
INSTITUTE OF SCIENCE & TECHNOLOGY
Bandlaguda, Hyderabad-500 005.

Vysapuri, Bandlaguda Post:Keshavgiri,
Hyderabad-500 005, TELANGANA INDIA
Tel: 040-64596979,8978380692,
Fax: 040-24455003
E-mail: principal.mahaveer@gmail.com
Website: www.mist.ac.in.

MAHAVEER

Approved by AICTE Affiliated to JNTUHYD

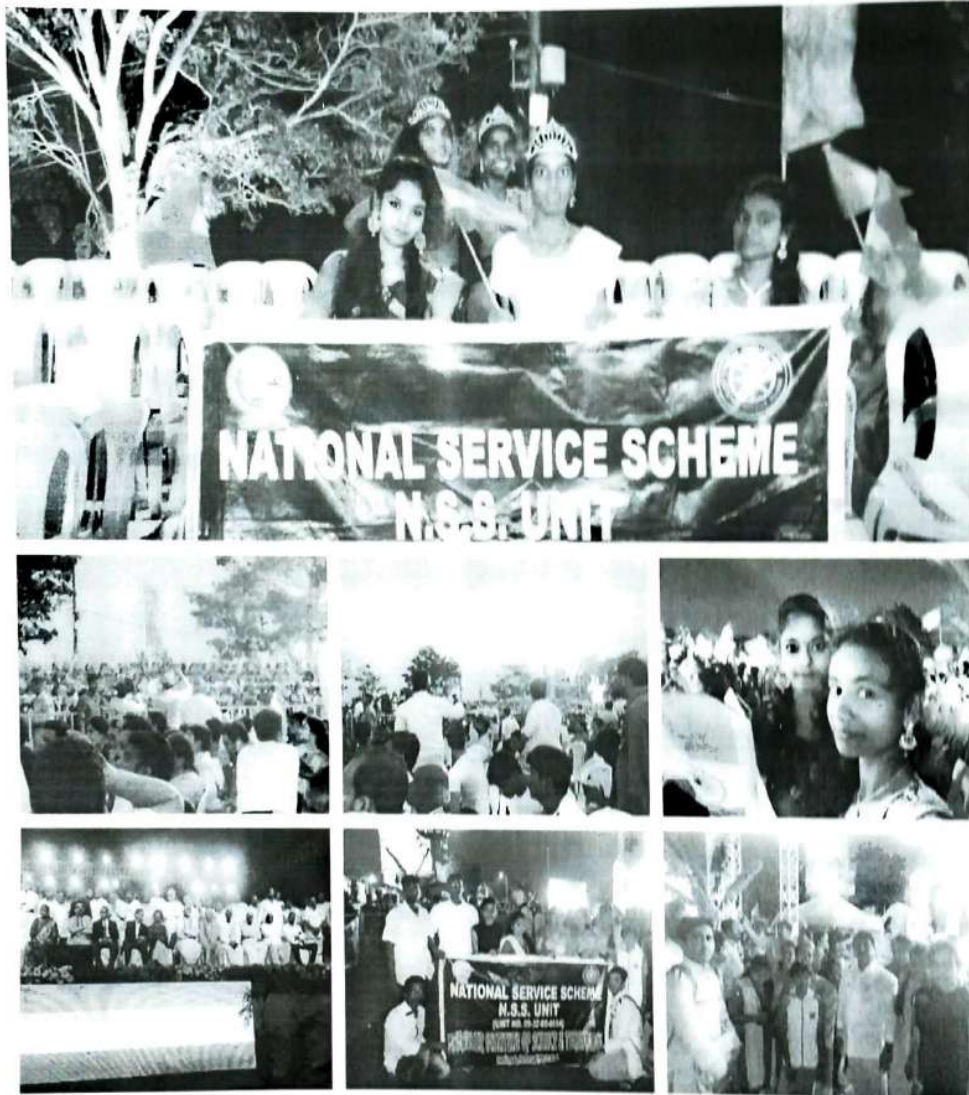

K. Sankar

MAHAVEER
INSTITUTE OF TECHNOLOGY
Bandlaguda, Hyd-500 005.

Vysapuri, Bandlaguda Post Keshavgiri,
Hyderabad-500 005, TELANGANA INDIA
Tel: 040-64596979,8978380692,
Fax: 040-24455003
E-mail: principal.mahaveer@gmail.com
Website: www.mist.ac.in,

MAHAVEER

Approved by AICTE, Affiliated to JNTUH,Hyd.



Dt:26/1/2019

EVENT NAME: BHARATHMATHA KI MAHA HARATHI

Faculty Organizing Committee

S NO	NAME OF THE FACULTY	DESIGNATION	DEPT
1	Dr M Vasanthaxmi	ASSOCIATE PROFERSOR	CIVIL

K. Subh
PRINCIPAL
MAHAVEER
INSTITUTE OF SCIENCE & TECHNOLOGY
Bandlaguda, Hyd-500 005.

2019
2019
2019

Vysapuri, Bandlaguda Post:Keshavgiri,
Hyderabad-500 005, TELANGANA INDIA
Tel: 040-64596979,8978380692,
Fax: 040-24455003
E-mail: principal.mahaveer@gmail.com
Website: www.mist.ac.in,

MAHAVEER

Approved by AICTE, Affiliated to JNTUH,Hyd



Dt:26/1/2019

EVENT NAME: BHARATHMATHA KI MAHA HARATHI

Student Participating Committee

S NO	NAME OF THE STUDENT	BRANCH	YEAR
1.	SADVIKA	CIVIL	I
2.	VAISHALI CHAVAN	EEE	I
3.	M MAMATHA	IT	I
4.	M POOJA	IT	I
5.	G MAMATHA	IT	I
6.	R SATYASRI RUPA	AERO	I
7.	K. RAMYA	CSE	I
8.	N RENU SREE	CSE	I
9.	M AISHWARYA	CSE	I
10.	PADMAVATHI	CSE	I

K. Sankar
Principal
MAHAVEER
INSTITUTE OF SCIENCE & TECHNOLOGY
Bandlaguda, Hyd-500 005.

Vysapuri, Bandlaguda Post: Keshavgiri,
Hyderabad-500 005, TELANGANA INDIA
Tel: 040-64596979, 8978380692
Fax: 040-24455003
E-mail: principal.mahaveer@gmail.com,
Website: www.mist.ac.in,

MAHAVEER

Approved by AICTE, Affiliated to JNTUH.Hyd.



Dt:01-02-2019

CIRCULAR

Sub: University Level Youth Festival

All the faculty members and students are here by informed that “**University Level Youth Festival**” will be organised by NSS unit of Mahaveer Institute of Science and Technology in Association with NSS CELL JNTUH KUKATPALLY is scheduled on **2ND FEBRUARY 2019** between 9.30AM to 2.00PM in JNTUH . Students, teaching and non-teaching staff members are requested to participate this event.

Copy to:
All Hod's, Principal
polytechnic, Exam
Branch incharge,
Librarian

PRINCIPAL
MAHAVEER
INSTITUTE OF SCIENCE & TECHNOLOGY
Bandlaguda, Hyd-500 005.

PRINCIPAL

Vysapuri, Bandlaguda Post:Keshavgiri,
Hyderabad-500 005, TELANGANA INDIA
Tel: 040-64596979,8978380692.
Fax: 040-24455003
E-mail: principal.mahaveer@gmail.com
Website: www.mist.ac.in.

MAHAVEER

Approved by AICTE. Affiliated to JNTUH Hyd



Dt:7/1/2019 – 9/1/2019

EVENT NAME:KANTI VELUGU PROGRAM

Faculty Organizing Committee

S NO	NAME OF THE FACULTY	DESIGNATION	DEPT
1	Dr M Vasanthaxmi	ASSOCIATE PROFERSOR	CIVIL

PRINCIPAL
MAHAVEER
INSTITUTE OF SCIENCE & TECHNOLOGY
Bandlaguda, Hyd-500 005.

Vysapuri, Bandlaguda Post:Keshavgiri,
Hyderabad-500 005, TELANGANA INDIA
Tel: 040-64596979,8978380692,
Fax: 040-24455003
E-mail: principal.mahaveer@gmail.com
Website: www.mist.ac.in,

MAHAVEER



Approved by AICTE, Affiliated to JNTUH, Hyd.

Dt:7/1/2019 – 9/1/2019

EVENT NAME:KANTI VELUGU PROGRAM

Student Organizing Committee

S NO	NAME OF THE STUDENT	BRANCH	YEAR
1.	ANUMULA SRAVAN KUMAR	ECE	II
2.	BONALA MANEESHA	ECE	II
3.	MEESA SUMITH CHANDRA	ECE	II
4.	SHIKARI SRI VIDYA	ECE	II
5.	KANDUKURI VINITHA	IT	II
6.	PATHA SAIKIRAN	IT	II
7.	RAVUTLA PRANEETH	IT	II
8.	BADAM RAHUL	EEE	II
9.	KAITHA SANDEEP	EEE	II
10.	SIRISHETTI SHASHANK	EEE	II
11.	G ABHILASH REDDY	MECH	II
12.	KANNA MANIKANTA	MECH	II
13.	DENDE SAI KIRAN	CIVIL	II
14.	TURUKA PAVANI	CIVIL	II
15.	BORRA SOMESHWAR REDDY	CSE	II
16.	LONE HARISH	CSE	II
17.	BAIMUTHAKA TRIVENI	CSE	II

K. Srinivas
PRINCIPAL
MAHAVEER
INSTITUTE OF SCIENCE & TECHNOLOGY
Bandlaguda, Hyd-500 005.

Vysapuri, Bandlaguda Post:Keshavgiri,
Hyderabad-500 005, TELANGANA INDIA
Tel: 040-64596979,8978380692.
Fax: 040-24455003
E-mail: principal.mahaveer@gmail.com,
Website: www.mist.ac.in,

MAHAVEER



Approved by AICTE, Affiliated to JNTUHYD.

Date: 08/1/2019

CIRCULAR

Sub: THREE DAYS YOUTH FESTIVAL AT CAMPUS

All the faculty members and students are here by informed that "THREE DAYS YOUTH FESTIVAL AT CAMPUS" will be organised by NSS unit of Mahaveer Institute Of Science and Technology is scheduled on 10th & 12th JANUARY 2019 between 10:00AM to 4:00PM in our college campus teaching and non-teaching staff members are requested to participate this event.

PRINCIPAL,

Copy to:
All Hod's, Principal
polytechnic, Exam
Branch incharge,
Librarian

PRINCIPAL
MAHAVEER
INSTITUTE OF SCIENCE & TECHNOLOGY
Bandlaguda, Hyd-500 005.

Vysapuri, Bandlaguda Post:Keshavagiri,
Hyderabad-500 005, TELANGANA INDIA
Tel: 040-64596979,8978380692.
Fax: 040-24455003
E-mail: principal.mahaveer@gmail.com
Website: www.mist.ac.in.

MAHAVEER



Approved by AICTE Affiliated to JNTUHT Hyd

Dt: 7/1/2019 – 9/1/2019

Programme 19: Kanti Velugu Program

This *Kanti Velugu (eye chekup)* program was a three days program conducted on 7-1-2019 and 9-1-2019 in MIST college auditorium with the help of *Telangana Govt.* Hospital Ghouse Nagar Bandlaguda organized by NSS unit MIST, nearly *500 members of students and faculties* has been checkup their eyes *spectacles and medicines* has distributed to the *needy people* and for good treatment for others has been suggested to other specialists. This program has been completed successfully under the chairperson *Sri S. Sudharshan Reddy garu*, Secretary and director *H.S.N Murthy garu*, principal *Dr. K.S.S.S.N Reddy garu*, and *Dr.M vasantha laxmi*.



NATIONAL SERVICE SCHEME
OF YOUTH AFFAIRS & SPORTS, GOVT. OF INDIA
HENRU TECHNOLOGICAL UNIVERSITY HYDERABAD
STITUTE OF SCIENCE & TECHNOLOGY
dlaguda, Post: Keshavagiri, Hyderabad - 500005

Kanti Velugu
MIST
INSTITUTE
Bandlaguda, Hyderabad-500005.

Vysapuri, Bandlaguda Post:Keshavgi,
Hyderabad-500 005, TELANGANA INDIA
Tel: 040-64596979,8978380692,
Fax: 040-24455003
E-mail: principal.mahaveer@gmail.com,
Website: www.mist.ac.in,

MAHAVEER



Approved by AICTE, Affiliated to JNTU(Hydr)

Date: 08/1/2019

CIRCULAR

Sub: THREE DAYS YOUTH FESTIVAL AT CAMPUS

All the faculty members and students are here by informed that “**THREE DAYS YOUTH FESTIVAL AT CAMPUS**” will be organised by NSS unit of Mahaveer Institute Of Science and Technology is scheduled on 10TH & 12th JANUARY 2019 between 10.0AM to 4.00PM in our college campus teaching and non-teaching staff members are requested to participate this event.

PRINCIPAL,

Copy to:
All Hod's, Principal
polytechnic, Exam
Branch incharge,
Librarian

PRINCIPAL
MAHAVEER
INSTITUTE OF SCIENCE & TECHNOLOGY
bandlaguda, Hyd-500 005.

Vysapuri, Bandlaguda Post: Keshavgi,
Hyderabad-500 005, TELANGANA INDIA
Tel: 040-64596979, 8978380692,
Fax: 040-24455003
E-mail: principal.mahaveer@gmail.com
Website: www.mist.ac.in.

MAHAVEER



Approved by AICTE, Affiliated to JNTUH Hyd

Dt: 7/1/2019 – 9/1/2019

EVENT NAME: KANTI VELUGU PROGRAM

Faculty Organizing Committee

S NO	NAME OF THE FACULTY	DESIGNATION	DEPT
1	Dr M Vasanthaxmi	ASSOCIATE PROFERSOR	CIVIL



PRINCIPAL

MAHAVEER

INSTITUTE OF SCIENCE & TECHNOLOGY

Bandlaguda, Hyd-500 005.

Vysapuri, Bandlaguda Post:Keshavgiri,
Hyderabad-500 005, TELANGANA INDIA
Tel: 040-64596979,8978380692,
Fax: 040-24455003
E-mail: principal.mahaveer@gmail.com
Website: www.mist.ac.in,

MAHAVEER



Approved by AICTE, Affiliated to JNTUH,Hyd.

Dt:7/1/2019 – 9/1/2019

EVENT NAME:KANTI VELUGU PROGRAM

Student Organizing Committee

S NO	NAME OF THE STUDENT	BRANCH	YEAR
1.	ANUMULA SRAVAN KUMAR	ECE	II
2.	BONALA MANEESHA	ECE	II
3.	MEESA SUMITH CHANDRA	ECE	II
4.	SHIKARI SRI VIDYA	ECE	II
5.	KANDUKURI VINITHA	IT	II
6.	PATHA SAIKIRAN	IT	II
7.	RAVUTLA PRANEETH	IT	II
8.	BADAM RAHUL	EEE	II
9.	KAITHA SANDEEP	EEE	II
10.	SIRISHETTI SHASHANK	EEE	II
11.	G ABHILASH REDDY	MECH	II
12.	KANNA MANIKANTA	MECH	II
13.	DENDE SAI KIRAN	CIVIL	II
14.	TURUKA PAVANI	CIVIL	II
15.	BORRA SOMESHWAR REDDY	CSE	II
16.	LONE HARISH	CSE	II
17.	BAIMUTHAKA TRIVENI	CSE	II

PRINCIPAL
MAHAVEER
INSTITUTE OF SCIENCE & TECHNOLOGY
Bandlaguda, Hyd-500 005.

Vysapuri, Bandlaguda Post:Keshavgiri,
Hyderabad-500 005, TELANGANA INDIA
Tel: 040-64596979,8978380692.
Fax: 040-24455003
E-mail: principal.mahaveer@gmail.com
Website: www.mist.ac.in.

MAHAVEER



Approved by AICTE. Affiliated to JNTUH,Hyd

Dt: 10-01-19to12-01-19

Programme 20: Three day youth festival

National Youth day celebrations is a *Three Day Youth Festival* program organized at *Vivekananda Institute of Human Excellence*, RK math ,Hyderabad from 10-01-19to12-01-19 for this program 100 *students* of Mahaveer Institute Of Science And Technology along with the *NSS program officer Dr.M Vasantha Lakshmi* were participated and after completion of this program students got the certificates also.

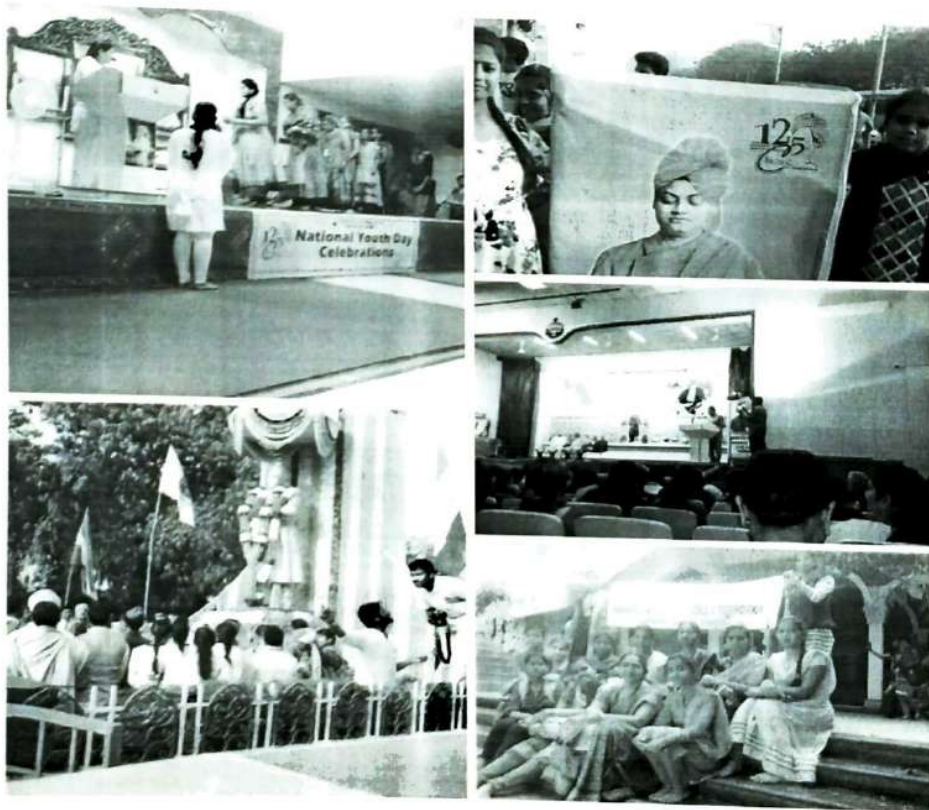

K. S. Lakshmi
M. S. S. S. S.
INSTITUTE OF SCIENCE & TECHNOLOGY
Bandlaguda, Hyd-500 005.

Vysapuri, Bandlaguda Post:Keshavgi,
Hyderabad-500 005, TELANGANA INDIA
Tel: 040-64596979,8978380692,
Fax: 040-24455003
E-mail: principal.mahaveer@gmail.com
Website: www.mist.ac.in,

MAHAVEER

Approved by AICTE, Affiliated to JNTUH,Hyd.



Dt: 10-01-19to12-01-19

EVENT NAME:THREE DAY YOUTH FESTIVAL

Faculty Organizing Committee

S NO	NAME OF THE FACULTY	DESIGNATION	DEPT
1	Dr M Vasanthaxmi	ASSOCIATE PROFERSOR	CIVIL

K. S. S. S.

PRINCIPAL
MAHAVEER
INSTITUTE OF SCIENCE & TECHNOLOGY
Bandlaguda, Hyd-500 005.

Vysapuri, Bandlaguda Post:Keshavgiri,
Hyderabad-500 005, TELANGANA INDIA
Tel: 040-64596979,8978380692,
Fax: 040-24455003
E-mail: principal.mahaveer@gmail.com
Website: www.mist.ac.in,

MAHAVEER

Approved by AICTE, Affiliated to JNTUH Hyd



75.	BHOOMIKA	EEE	I
76.	MOHMED ATHER UDDIN	EEE	I
77.	BHARATH KUMAR	DECE	I
78.	SANIYA MUNUAVAR	DECE	I
79.	SAI SHIVANI	DECE	I
80.	B MOUNIKA	DECE	I
81.	SIRI VENNALA	DECE	I
82.	NAVYASRI	DECE	I
83.	PAVITHRA	DECE	I
84.	USHA	DECE	I
85.	HARSHITHA	DECE	I
86.	SOUMYA	DECE	I
87.	AKANKSHA	DECE	I
88.	SATHVIKA	DECE	I
89.	MUJTABA AHMED	MECH	I
90.	ABHILASH CHARY	MECH	I
91.	P UMAMAHESHWAR	DECE	I
92.	P SANJAY	DECE	I
93.	M ADITHYA	DECE	I
94.	N NIKHIL	DECE	I
95.	K NIKHIL	DECE	I
96.	SUMITH	DECE	I
97.	NITHIN	DECE	I
98.	VASU	DECE	I
99.	SRIHARI	DECE	I
100.	D VENKATESH	DECE	I

K. Sankar

MAHAVEER
INSTITUTE OF TECHNOLOGY
Bandlaguda, Hyd-500 005.

Vysapuri, Bandlaguda Post:Keshavgi,
Hyderabad-500 005, TELANGANA INDIA
Tel: 040-64596979,8978380692,
Fax: 040-24455003
E-mail: principal.mahaveer@gmail.com
Website: www.mist.ac.in,

MAHAVEER



Approved by AICTE, Affiliated to JNTUH Hydr

34.	SAI PRIYA	DECE	II
35.	RAMYA SREE	DECE	II
36.	PRANATHI	DEEE	II
37.	R KAVERI	DEEE	I
38.	G LAYA	DEEE	I
39.	J SWATHKA	DEEE	I
40.	V SAI SHIVA	DECE	I
41.	S RISHI KETHAN	DECE	I
42.	B KEERTHANA	DECE	I
43.	V MOUNIKA	DECE	I
44.	B SAI PAVAN	DECE	I
45.	S VINAY KUMAR	DECE	I
46.	Y RAHUL	DECE	I
47.	P SAI JYOTHI	DECE	I
48.	R SAI DURGHA	DECE	I
49.	SOMU VENKAT	DECE	I
50.	NITHIN	DECE	I
51.	D SHRAVANI	DECE	II
52.	V HEMA	DECE	II
53.	C NIDHI SRINIVASA	DECE	II
54.	B DIVYA	DECE	II
55.	Y DEEPIKA	DECE	II
56.	G RAJESH	DECE	I
57.	D VANI	DECE	I
58.	O SATHYA	DEEE	I
59.	L VARSHA TEJ	DECE	I
60.	TEJASHRAVANI	DECE	I
61.	ROOPA	DECE	I
62.	ASHISH	DMECH	II
63.	ANIL	DMECH	II
64.	NIKHIL	DMECH	II
65.	VARSHITHA	DECE	I
66.	BANU	DECE	I
67.	VASANTH	DECE	I
68.	SAI KARTHIK	DECE	I
69.	VEERA GANESH	DECE	I
70.	K ADITHYA	EEE	II
71.	A AKILESH	ECE	II
72.	K BHANU PRAKASH	ECE	II
73.	KUSUMA	EEE	I
74.	AKSHAYA	EEE	I

K. Srinivas

MAHAVEER INSTITUTE OF TECHNOLOGY
Bandlaguda, Hyd-500 005.

Vysapuri, Bandlaguda Post:Keshavgiri,
Hyderabad-500 005, TELANGANA INDIA
Tel: 040-64596979,8978380692,
Fax: 040-24455003
E-mail: principal.mahaveer@gmail.com
Website: www.mist.ac.in,

MAHAVEER



Approved by AICTE, Affiliated to JNTUH,Hyd.

Dt: 10-01-19to12-01-19

EVENT NAME:THREE DAY YOUTH FESTIVAL

Student Participating Committee

S NO	NAME OF THE STUDENT	BRANCH	YEAR
1.	K SHIVA SAI	DME	II
2.	K SANDHYA	DCE	I
3.	G KARUNA	DCE	I
4.	K MYTHRI	DCE	I
5.	B SARASWATHI	DCE	I
6.	APARNA	DCE	I
7.	KUSUMA PRIYA	DCE	I
8.	SAMMJUL JOHNSON	DCE	I
9.	P ARUNN KUMAR	DCE	I
10.	M SRI SHIVANI	CSE	I
11.	B SUMA	CSE	I
12.	TANVI BHONSLE	DEEE	I
13.	SHAIID UMAIR AHMED	DEEE	I
14.	MD NAYEEM	DEEE	I
15.	P SHASHIVARDAN	DEEE	I
16.	S YASH RAJ	DEE	I
17.	ARSHITH	DECE	I
18.	G SRI RAM	DECE	I
19.	CH KEERTHI	DECE	I
20.	G VAISHNAVI	DECE	I
21.	B JOHSNA	DECE	I
22.	K MANOJ KUMAR	DECE	I
23.	B VENKATA CHARY	DECE	I
24.	CH VENKATALAXMINARASIMHA RAO	AERO	I
25.	T RADHIKA	AERO	I
26.	S NAGALXMI	AERO	I
27.	B DIVYA	MECH	I
28.	M PRATHIBHA	AERO	I
29.	S OMAIR AHMED	MECH	III
30.	I SAI GANESH	MECH	II
31.	N ADITHYA	DCE	I
32.	VAISHANI DEVI	DCE	I
33.	SHARANYA	DECE	I

K. S. S. S.
Principal
MAHAVEER
INSTITUTE OF SCIENCE & TECHNOLOGY
Bandlaguda, Hyd-500 005.

Vysapuri, Bandlaguda Post:Keshavgi,
Hyderabad-500 005, TELANGANA INDIA
Tel: 040-64596979,8978380692,
Fax: 040-24455003
E-mail: principal.mahaveer@gmail.com,
Website: www.mist.ac.in,

MAHAVEER



Approved by AICTE, Affiliated to JNTUH,Hyd.

Dt: 21/01/2019

CIRCULAR

Sub: Viveka Subhashitham

All the faculty members and students are here by informed that “Viveka Subhashitham” will be organised by NSS unit of Mahaveer Institute of Science and Technology in Association samskruthi foundation is scheduled on 23RD JANUARY 2019 between 9.30AM to 2.00PM at RK MATH AUDITORIUM . Students, teaching and non-teaching staff members are requested to participate this event.

Copy to:

All Hod's, Principal
polytechnic, Exam
Branch incharge,
Librarian

PRINCIPAL
MAHAVEER
INSTITUTE OF SCIENCE & TECHNOLOGY
Bandlaguda, Hyd-500 005.

PRINCIPAL

Vysapuri, Bandlaguda Post:Keshavgiri,
Hyderabad-500 005, TELANGANA INDIA
Tel: 040-64596979,8978380692,
Fax: 040-24455003
E-mail: principal.mahaveer@gmail.com
Website: www.mist.ac.in,

MAHAVEER



Approved by AICTE, Affiliated to JNTUH,Hyd.

19.	SADVIKA	CIVIL	I
20.	PREM SAI	CIVIL	I
21.	KARTHEEK	CIVIL	I
22.	JOY JARUSHA	CSE	I

K. S. S. S.

PRINCIPAL
MAHAVEER
INSTITUTE OF SCIENCE & TECHNOLOGY
Bandlaguda, Hyd-500 005.

Vysapuri, Bandlaguda Post:Keshavgi,
Hyderabad-500 005, TELANGANA INDIA
Tel: 040-64596979,8978380692,
Fax: 040-24455003
E-mail: principal.mahaveer@gmail.com
Website: www.mist.ac.in,

MAHAVEER

Approved by AICTE, Affiliated to JNTUH.Hyd.



Dt:17/2/2019

EVENT NAME:SWAMI VIVEKANANDA AND THE RELEVANCE OF HIS MESSAGE IN THE 21ST CENTURY

Student Participating Committee

S NO	NAME OF THE STUDENT	BRANCH	YEAR
1.	G VISHWATEJ REDDY	ECE	I
2.	P VINEETH KUMAR	ECE	I
3.	K KARTHIK	ECE	I
4.	R SATYASRI RUPA	AERO	I
5.	K RAHUL	AERO	I
6.	P PRUTHVI SHANKAR	AERO	I
7.	N DEEPAK	AERO	I
8.	G MAMATHA	IT	I
9.	M POOJA	IT	I
10.	M MAMATHA	IT	I
11.	VAISHALI CHAVAN	EEE	I
12.	E NAVEEN	EEE	I
13.	PADMAVATHI	CSE	I
14.	M VINAY	CSE	I
15.	M AISHWARYA	CSE	I
16.	N RENU SREE	CSE	I
17.	K. RAMYA	CSE	I
18.	R KALYAN SAI	CSE	I

PRINCIPAL
MAHAVEER
INSTITUTE OF SCIENCE & TECHNOLOGY
HYDERABAD-500 005.

Vysapuri, Bandlaguda Post:Keshavgiri,
Hyderabad-500 005, TELANGANA INDIA
Tel: 040-64596979,8978380692.
Fax: 040-24455003
E-mail: principal.mahaveer@gmail.com
Website: www.mist.ac.in.

MAHAVEER



Approved by AICTE, Affiliated to JNTUH,Hyd

Dt: 17/02/2019

Programme 25: Swami Vivekananda and the Relevance of his message in the 21st century

It is a one day national level seminar on the *Swami Vivekananda and the relevance of his message in the 21st century on the occasion of 125th Anniversary celebrations of the Chicago Address* of Swami Vivekananda in the world parliament religions conducted at Vivekananda auditorium on 17/02/2019, on this day guest speakers were *Rev. srimat Swami Gautamanadaji Maharaj* vice president RK math Chennai, *Justice V Ramasubramanian* hon'ble Judge of Telangana High Court, *Prof.Sumita Roy* Head Depatment of English OU, *Sri vijay Menon* Human Resources Academician Kochi, *Swami Raghunayakananda* RK math Chennai, *Swami Buddhidananda* RK math Hyderabad. Nearly 25 members were participated in this Programme and students gained benefit to become excellent citizens in the future.

PRINCIPAL
MAHAVEER
INSTITUTE OF SCIENCE & TECHNOLOGY
Bandlaguda, Hyd-500 005.

Vysapuri, Bandlaguda Post:Keshavgiri,
Hyderabad-500 005, TELANGANA INDIA
Tel: 040-64596979,8978380692,
Fax: 040-24455003
E-mail: principal.mahaveer@gmail.com,
Website: www.mist.ac.in,

MAHAVEER



Approved by AICTE, Affiliated to JNTUH.Hyd.

Dt: 16/02/2019

CIRCULAR

Sub: Swami Vivekananda and the Relevance of his message in the 21st century

All the faculty members and students are here by informed that “Swami Vivekananda and the Relevance of his message in the 21st century” will be organised by NSS unit of Mahaveer Institute of Science and Technology is scheduled on 17TH FEBRUARY 2019 between 9.30AM to 2.00PM in our college campus. Students, teaching and non-teaching staff members are requested to participate this event.

Copy to:

All Hod's, Principal
polytechnic, Exam
Branch incharge,
Librarian

PRINCIPAL
MAHAVEER
INSTITUTE OF SCIENCE & TECHNOLOGY
Bandlaguda, Hyd-500 005.

PRINCIPAL

Vysapuri, Bandlaguda Post:Keshavgi,
Hyderabad-500 005, TELANGANA INDIA
Tel: 040-64596979,8978380692.
Fax: 040-24455003
E-mail: principal.mahaveer@gmail.com
Website: www.mist.ac.in,

MAHAVEER

Approved by AICTE. Affiliated to JNTUH,Hyd



Dt:02/02/2019

EVENT NAME:UNIVERSITY LEVEL YOUTH FESTIVAL

Faculty Organizing Committee

S NO	NAME OF THE FACULTY	DESIGNATION	DEPT
1	Dr M Vasanthaxmi	ASSOCIATE PROFESSOR	CIVIL

9

the

t the

ions

ed at

ami

tian

Sri

nath

l in

PRINCIPAL
MAHAVEER
INSTITUTE OF SCIENCE & TECHNOLOGY
Bandlaguda, Hyd-500 005.

Vysapuri, Bandlaguda Post:Keshavgi,
Hyderabad-500 005, TELANGANA INDIA
Tel: 040-64596979,8978380692,
Fax: 040-24455003
E-mail: principal.mahaveer@gmail.com
Website: www.mist.ac.in,

MAHAVEER

Approved by AICTE, Affiliated to JNTUH,Hyd



Dt:2/2/2019

EVENT NAME:UNIVERSITY LEVEL YOUTH FESTIVAL

Student Participating Committee

S NO	NAME OF THE STUDENT	EVENT	BRANCH	YEAR
1.	SYED KHALIF	ELECUTION	CSE	II
2.	SYED FAISAL	ELECUTION	CSE	I
3.	SHIAV SAI	DEBATE	DMECH	II
4.	SUDESH TIWARI	DEBATE	DEEE	II
5.	GAYATRI	ESSAY WRITING	IT	III
6.	KIRAN KUMARI	ESSAY WRITING	IT	I
7.	SAINATH	QUIZ	CSE	III
8.	TEJASWINI	QUIZ	CIVIL	I
9.	SATYA SRI RUPA	QUIZ	AERO	I
10.	K RAHUL	PATRIOTIC POEM	AERO	I
11.	ADHITYA	POSTER PAINTING	ECE	I
12.	KEERTHI KANKOT	POSTER PAINTING	AERO	II
13.	BHARGHAVI	RANGOLI	DCIVIL	II
14.	DEEPIKA	RANGOLI	DCIVIL	II
15.	SOUJANYA	DCIVIL	DCIVIL	II
16.	AYUSHMAN	INSTRUMENTAL MUSIC	AERO	II
17.	ARSHI FIRDAUSH	CLASSICAL DANCE	CIVIL	II
18.	B KRISHNA SAI	GROUP DANCE	CSE	IV
19.	B YAKANNA	GROUP DANCE	ECE	IV
20.	GANESH	GROUP DANCE	CSE	I
21.	SPHOORTHY	GROUP DANCE	ECE	IV
22.	HARINI	GROUP DANCE	ECE	IV
23.	JOY	GROUP DANCE	CSE	I
24.	P SAI JYOTHI	SOLO SONG	ECE	I
25.	R TEJA SRAVANI	SOLO SONG	ECE	I
26.	SPANDANA	EXHIBITION	AERO	II
27.	JUNAID	EXHIBITION	AERO	II
28.	P ROHITH KUMAR	EXHIBITION	AERO	II
29.	SHIVA SAHITHI REDDY	EXHIBITION	AERO	II
30.	N MANISH YADAV	EXHIBITION	AERO	II
31.	MAROOF	EXHIBITION	AERO	II
32.	SMARANI	COORDINATOR	CIVIL	II

K. Srinivas
PRINCIPAL
MAHAVEER
INSTITUTE OF SCIENCE & TECHNOLOGY
Bandlaguda, Hyd 500 005.

Vysapuri, Bandlaguda Post Keshavgiri,
Hyderabad-500 005, TELANGANA INDIA
Tel: 040-64596979,8978380692
Fax: 040-24455003
E-mail: principal.mahaveer@gmail.com
Website: www.mist.ac.in.

MAHAVEER



Approved by AICTE Affiliated to JNTU(Hyd)

DC:02-02-2019

Programme 24: University Level Youth Festival

This program was organized by *NSS Cell JNTUH kukatpally Hyderabad* by the direction of Honourable vice chancellor JNTUH and the state NSS Office Telanagana. For this college *NSS volunteers* conducted some events like *Election, Debate, poster presentation, patriotic poem etc.* in the college campus. In these events the short listed students were got a chance to attend the *National level Youth Festival* at JNTUH along with *NSS Coordinator DR.M Vasantha Lakshmi* on 02.02.2021. In these short listed students two students got the certificates.

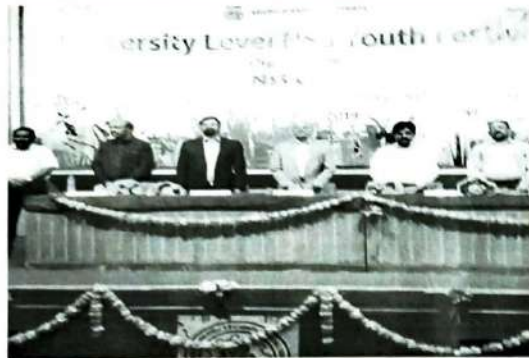

Kshiraj

M. S. S. S. S.
INSTITUTE OF TECHNOLOGY
Bandlaguda, Hyd-500 005.

Vysapuri, Bandlaguda Post Keshavgiri,
Hyderabad-500 005, TELANGANA INDIA
Tel: 040-64596979,8978380692.
Fax: 040-24455003
E-mail: principal_mahaveer@gmail.com,
Website: www.mist.ac.in,

MAHAVEER



Approved by AICTE, Affiliated to JNTUH.Hyd.

Dt:01-02-2019

CIRCULAR

Sub: University Level Youth Festival

All the faculty members and students are here by informed that “**University Level Youth Festival**” will be organised by NSS unit of Mahaveer Institute of Science and Technology in Association with NSS CELL JNTUH KUKATPALLY is scheduled on **2ND FEBRUARY 2019** between 9.30AM to 2.00PM in JNTUH . Students, teaching and non-teaching staff members are requested to participate this event.

Copy to:

All Hod's, Principal
polytechnic, Exam
Branch incharge,
Librarian

PRINCIPAL
MAHAVEER
INSTITUTE OF SCIENCE & TECHNOLOGY
Bandlaguda, Hyd-500 005.

PRINCIPAL

Vysapuri, Bandlaguda Post Keshavgiri,
Hyderabad-500 005, TELANGANA INDIA
Tel: 040-64596979,8978380692,
Fax: 040-24455003
E-mail: principal.mahaveer@gmail.com
Website: www.mist.ac.in,

MAHAVEER



Approved by AICTE, Affiliated to JNTUH, Hyd

Dt:26/1/2019

EVENT NAME: BHARATHMATHA KI MAHA HARATHI

Faculty Organizing Committee

S NO	NAME OF THE FACULTY	DESIGNATION	DEPT
1	Dr M Vasanthaxmi	ASSOCIATE PROFERSSOR	CIVIL

K. S. S. S.
PRINCIPAL
MAHAVEER
INSTITUTE OF SCIENCE & TECHNOLOGY
Bandlaguda, Hyd-500 005.

037
HYD
Tel
Fax
E-4
W

Vysapuri, Bandlaguda Post:Keshavgiri,
Hyderabad-500 005, TELANGANA INDIA
Tel: 040-64596979,8978380692,
Fax: 040-24455003
E-mail: principal.mahaveer@gmail.com
Website: www.mist.ac.in,

MAHAVEER

Approved by AICTE, Affiliated to JNTUH,Hyd



Dt:26/1/2019

EVENT NAME: BHARATHMATHA KI MAHA HARATHI

Student Participating Committee

S NO	NAME OF THE STUDENT	BRANCH	YEAR
1.	SADVIKA	CIVIL	I
2.	VAISHALI CHAVAN	EEE	I
3.	M MAMATHA	IT	I
4.	M POOJA	IT	I
5.	G MAMATHA	IT	I
6.	R SATYASRI RUPA	AERO	I
7.	K. RAMYA	CSE	I
8.	N RENU SREE	CSE	I
9.	M AISHWARYA	CSE	I
10.	PADMAVATHI	CSE	I



INSTITUTE OF SCIENCE & TECHNOLOGY
Bandlaguda, Hyd-500 005.

Vysapuri, Bandlaguda Post: Keshavgirl,
Hyderabad-500 005, TELANGANA INDIA
Tel: 040-64596979, 8978380692.
Fax: 040-24455003
E-mail: principal.mahaveer@gmail.com
Website: www.mist.ac.in.

MAHAVEER

Approved by AICTE Affiliated to JNTU Hyderabad



Kanika

MAHAVEER
INSTITUTE OF TECHNOLOGY
Bandlaguda, Hyd 500 005.

Vysapuri, Bandlaguda Post:Keshavgiri,
Hyderabad-500 005, TELANGANA INDIA
Tel: 040-64596979,8978380692.
Fax: 040-24455003
E-mail: principal.mahaveer@gmail.com
Website: www.mist.ac.in.

MAHAVEER

INSTITUTE OF SCIENCE & TECHNOLOGY

Approved by AICTE. Affiliated to JNTUH,Hyd.



Dt:26-01-2019

Programme 23: Bharathmatha ki Maha Harathi

This program was organized by *Bharath matha Foundation*, at peoples plaza Hyderabad at 5.00pm, chief guest of this program is *Sri Chaganti Koteswara Rao Garu* and *Sri G.Kishan Reddy garu founder of Bharath Mata Foundation*, To Celebrate the Spirit Of Patriotism At The Maha Harathi and tribute to the nation on the occasion of republic day. 1000's of people were participated in this event. The main motto of this event is for *Gunnis world record* by this India had created a new record with 1000 girls dressed in the attire of Bharatha Mata while presenting the **Tiranga Theme**. On this special event our college students were also participated.

K. Srinivas
Principal
MAHAVEER
INSTITUTE OF SCIENCE & TECHNOLOGY
Bandlaguda, Dist: 500 005.

Vysapuri, Bandlaguda Post:Keshavgiri,
Hyderabad-500 005, TELANGANA INDIA
Tel: 040-64596979,8978380692,
Fax: 040-24455003
E-mail: principal.mahaveer@gmail.com,
Website: www.mist.ac.in,

MAHAVEER



Approved by AICTE, Affiliated to JNTUH,Hyd.

Dt:24-01-2019

CIRCULAR

Sub: Bharathmatha ki Maha Harathi

All the faculty members and students are here by informed that "Bharathmatha ki Maha Harathi will be organised by NSS unit of Mahaveer Institute of Science and Technology in Association with bharatha matha foundation scheduled on 26TH JANUARY 2019 between 9.30AM to 2.00PM peoples plaza hyderabad. Students, teaching and non-teaching staff members are requested to participate this event.

Copy to:

All Hod's, Principal
polytechnic, Exam
Branch incharge,
Librarian

PRINCIPAL
MAHAVEER
INSTITUTE OF SCIENCE & TECHNOLOGY
Bandlaguda, Hyd-500 005.

PRINCIPAL

Vysapuri, Bandlaguda Post:Keshavgiri,
Hyderabad-500 005, TELANGANA INDIA
Tel: 040-64596979,8978380692,
Fax: 040-24455003
E-mail: principal.mahaveer@gmail.com
Website: www.mist.ac.in,

MAHAVEER

Approved by AICTE. Affiliated to JNTUH,Hyd



Dt:26/1/2019

EVENT NAME:REPUBLIC DAY CELEBRATIONS AT MIST CAMPUS

Faculty Organizing Committee

S NO	NAME OF THE FACULTY	DESIGNATION	DEPT
1	Dr M Vasanthaxmi	ASSOCIATE PROFERSOR	CIVIL

Keshav
Principal
MAHAVEER
INSTITUTE OF SCIENCE & TECHNOLOGY
Bandlaguda, Hyd-500 005.

Vysapuri, Bandlaguda Post: Keshavgiri,
Hyderabad-500 005, TELANGANA INDIA
Tel: 040-64596979,8978380692
Fax: 040-24455003
E-mail: principal.mahaveer@gmail.com
Website: www.mist.ac.in,

MAHAVEER



Approved by AICTE, Affiliated to JNTUH.Hyd

43	LONE HARISH	CSE	II
----	-------------	-----	----

K. Sankar
M. S. Sankar
INSTITUTE OF SCIENCE & TECHNOLOGY
Bandlaguda, Hyd-500 005.

Vysapuri, Bandlaguda Post:Keshavgi,
Hyderabad-500 005, TELANGANA INDIA
Tel: 040-64596979,8978380692,
Fax: 040-24455003
E-mail: principal.mahaveer@gmail.com
Website: www.mist.ac.in,

MAHAVEER

Approved by AICTE, Affiliated to JNTUH, Hyd



20	NEELA JASHWANTH	ECE	III
21	SURE PRATHYUSHA	ECE	III
22	GUDAPATI VEENA	EEE	III
23	MANNE SRIDHAR	EEE	III
24	BADAM ABILASH	CSE	III
25	PAPINENI MANOJ KUMAR	CSE	III
26	RIKKA VANDANA	CSE	III
27	BANDA MOUNIKA YADAV	ECE	II
28	KONDI AKHILA	ECE	II
29	V RAHUL	ECE	II
30	LOKA SAMHITHA	IT	II
31	PATHA SAIKIRAN	IT	II
32	BADAM RAHUL	EEE	II
33	MALKAGIRI RAKESH	EEE	II
34	BASANOLA JAYVARDHAN	MECH	II
35	G ABHILASH REDDY	MECH	II
36	TEJAVATH LAXMAN	MECH	II
37	DENDE SAI KIRAN	CIVIL	II
38	TURUKA PAVANI	CIVIL	II
39	ADIRE SPANDANA	AERO	II
40	SAMBARU VIKAS	AERO	II
41	GEETHIKA C	CSE	II
42	GURRAM MANI RUPAK	CSE	II

K. Srinivas

PT

M.A.

MAHAVEER INSTITUTE OF SCIENCE & TECHNOLOGY
Bandlaguda, Hyderabad-500 005

Vysapuri, Bandlaguda Post Keshavgi,
Hyderabad 500 005, TELANGANA INDIA
Tel: 040-64596979,8978380692
Fax: 040-24455003
E-mail: principal.mahaveer@gmail.com
Website: www.mist.ac.in,

MAHAVEER

Approved by AICTE Affiliated to JNTU-Hydr



Dt:26/1/2019

EVENT NAME: REPUBLIC DAY CELEBRATIONS AT MIST CAMPUS

Student Participating Committee

S NO	STUDENT NAME	BRANCH	YEAR
1.	N.R SRILEJ	MECH	IV
2.	SINGANABOINA SURESH	MECH	IV
3.	M AJAY	MECH	IV
4.	BANDI PRIYANKA	AERO	IV
5.	LONKA VAMSHI KRISHNA	AERO	IV
6.	PANJAGUTTA PRIYANKA	AERO	IV
7.	BOMMA ABHISHEK	CIVIL	IV
8.	ELISHETTY TEJASWINI	CIVIL	IV
9.	PALLE PRASHANTH KUMAR	CIVIL	IV
10.	DORAGARI NIKHITHA	IT	IV
11.	ARVA SHASHANK	CSE	IV
12.	PAYAPULA MAHENDAR	CSE	IV
13.	POTLA SIDDARTHA	CSE	IV
14.	BANDAPELLI SPOORTHI	ECE	IV
15.	DOSADA SOWMYA	ECE	IV
16.	M RADHIKA	ECE	IV
17.	B NAVYA SRI	ECE	III
18.	ERUGU CHANDU	ECE	III
19.	B PRADEEP	ECE	III

Kanhi

Vysapuri, Bandlaguda Post Keshavnagar,
Hyderabad-500 005, TELANGANA INDIA
Tel: 040-64596979,8978380692
Fax: 040-24455003
E-mail: principal.mahaveer@gmail.com
Website: www.mist.ac.in

MAHAVEER

Approved by AICTE Affiliated to JNTU-Hydr



Dt: 26/01/2019

Programme 22: Republic Day celebrations at MIST Campus

On the occasion of *Republic day celebrations at MIST college campus*, NSS Volunteers did the *NSS pured* in the college campus for this all the NSS volunteers were participated and appreciated by the College management and after that flag hosting done by chairmen Sri S.Sudharshan Reddy garu, secretary Sri S.Surendar reddy garu, principal Dr.K.S.S.N Reddy garu for this all the faculty members and Students were participated after that Other culture activities had been conducted and certificates also distributed to the students.



Khan

Principal
Bandlaguda, Hyderabad-500 005.

Vysapuri, Bandlaguda Post, Keshavgi,
Hyderabad-500 005, TELANGANA INDIA
Tel: 040-64596979, 8978380692
Fax: 040-24455003
E-mail: principal.mahaveer@gmail.com,
Website: www.mist.ac.in,

MAHAVEER



Approved by AICTE, Affiliated to JNTUH, Hyd.

Dt: 25/01/2019

CIRCULAR

Sub: Republic Day celebrations at MIST Campus

All the faculty members and students are hereby informed that “**Republic Day celebrations at MIST Campus**” will be organised by NSS unit of Mahaveer Institute of Science and Technology is scheduled on **26TH JANUARY 2019** between 9.30AM to 2.00PM in our college campus. Students, teaching and non-teaching staff members are requested to participate this event.

PRINCIPAL

Copy to:

All Hod's, Principal
polytechnic, Exam
Branch incharge,
Librarian

PRINCIPAL
MAHAVEER
INSTITUTE OF SCIENCE & TECHNOLOGY
Bandlaguda, Hyd-500 005.

Vysapuri, Bandlaguda Post:Keshavgiri,
Hyderabad-500 005, TELANGANA INDIA
Tel: 040-64596979,8978380692,
Fax: 040-24455003
E-mail: principal_mahaveer@gmail.com
Website: www.mist.ac.in,

MAHAVEER

Approved by AICTE, Affiliated to JNTUH,Hyd.



Dt:23/1/2019

EVENT NAME:VIVEKA SUBHASHITHAM

Faculty Organizing Committee

S NO	NAME OF THE FACULTY	DESIGNATION	DEPT
1	Dr M Vasanthaxmi	ASSOCIATE PROFESSOR	CIVIL

K. S. R.

PRINCIPAL
MAHAVEER
INSTITUTE OF TECHNOLOGY
Bandlaguda, Hyd-500 005.

Vysapuri, Bandlaguda Post, Keshavgi,
Hyderabad-500 005, TELANGANA INDIA
Tel: 040-64596979,8978380692.
Fax: 040-24455003
E-mail: principal_mahaveer@gmail.com
Website: www.mlst.ac.in,

MAHAVEER



Approved by AICTE. Affiliated to JNTUH Hyd

66.	H SANTHOSH	ECE	I
67.	P ANIRUDH	ECE	I
68.	GAYATRI	ECE	I
69.	Y PAVAN	ECE	I
70.	K SAI PRASANNA	ECE	I
71.	N SHIVA JYOTHI	ECE	I
72.	B SWAPNA	ECE	I
73.	K ASRITHA	ECE	I
74.	R HARITHA	ECE	I
75.	J KAVERI	ECE	I
76.	P SHIVAJYOTHI	ECE	I
77.	NEHA JABEEN	ECE	I
78.	CHANDANA	ECE	I
79.	M MUKUNDINI	ECE	I
80.	BHARATH	CIVIL	I

K. Srinivas

PRINCIPAL
MAHAVEER
INSTITUTE OF SCIENCE & TECHNOLOGY
Bandlaguda, Hyd-500 005.

Vysapuri, Bandlaguda Post:Keshavgiri,
Hyderabad-500 005, TELANGANA INDIA
Tel: 040-64596979,8978380692,
Fax: 040-24455003
E-mail: principal.mahaveer@gmail.com
Website: www.mist.ac.in,

MAHAVEER



Approved by AICTE, Affiliated to JNTUH,Hyd

43.	P PREM SAI	CIVIL	I
44.	R CHARAN	CIVIL	I
45.	R BALARAJ	CIVIL	I
46.	R SHANKAR	CIVIL	I
47.	R NIKHL	CIVIL	I
48.	RAYAN	CIVIL	I
49.	R BHARATH	CIVIL	I
50.	BHEEM REDDY	CIVIL	I
51.	S AKASH	CIVIL	I
52.	FAISAL	CIVIL	I
53.	M BHANU TEJA	ECE	I
54.	ABHINAV MOHANTH	ECE	I
55.	P SHIVA PRASAD	ECE	I
56.	CH PRANAY RAJ	ECE	I
57.	K PRANY	ECE	I
58.	A LOUSHIK	ECE	I
59.	G VISHWATEJA REDDY	ECE	I
60.	R HARISH KUMAR	ECE	I
61.	V ABHINAV	ECE	I
62.	B TEJA	ECE	I
63.	G HARSHITH	ECE	I
64.	G SANDDEP KUMAR	ECE	I
65.	B NAVEENKUMAR	ECE	I

Hyderabad
MAHAVEER
INSTITUTE OF TECHNOLOGY
Bandlaguda, Hyderabad-500 005.

Vysapuri, Bandlaguda Post, Keshavgiri,
Hyderabad-500 005, TELANGANA INDIA
Tel: 040-64596979,8978380692,
Fax: 040-24455003
E-mail: principal.mahaveer@gmail.com
Website: www.mist.ac.in,

MAHAVEER



Approved by AICTE, Affiliated to JNTUH,Hyd

20.	MA QUAREEZ AID	ECE	1
21.	A SHRAVAN	IT	1
22.	P SHIVA PRASAD	ECE	1
23.	K MAHESHBABU	ECE	1
24.	H PAVAN KUMAR	ECE	1
25.	Q RAJASHEKAR	ECE	1
26.	G NAGA RAJ	ECE	1
27.	A SRILEKHA	CIVIL	1
28.	B ANIL NAIK	CIVIL	1
29.	CH SANJEEV	CIVIL	1
30.	CHANDRAVARDHAN	CIVIL	1
31.	D JAYA SIMHA	CIVIL	1
32.	D KALYAN	CIVIL	1
33.	D TARUN KUMAR	CIVIL	1
34.	D YUVA KUMAR	CIVIL	1
35.	G HARSHA VARDHAN	CIVIL	1
36.	G VEENEETH	CIVIL	1
37.	K MANEESH	CIVIL	1
38.	K REAVANTH REDDY	CIVIL	1
39.	MD NADEEM	CIVIL	1
40.	MA WAJAHATHI	CIVIL	1
41.	ATIF	CIVIL	1
42.	N NAVVEN RAM	CIVIL	1

K. Srinivas

Principal
MAHAVEER INSTITUTE OF SCIENCE & TECHNOLOGY
Bandlaguda, Hyderabad-500 005.

Vysapuri, Bandlaguda Post:Keshavgiri,
Hyderabad-500 005, TELANGANA INDIA
Tel: 040-64596979,8978380692.
Fax: 040-24455003
E-mail: principal.mahaveer@gmail.com
Website: www.mist.ac.in,

MAHAVEER



Approved by AICTE, Affiliated to JNTUH,Hyd

Dt:23/1/2019

EVENT NAME:VIVEKA SUBHASHITHAM

Student Participating Committee

S NO	NAME OF THE STUDENT	BRANCH	YEAR
1.	G MAMATHA	IT	1
2.	M MAMATHA	IT	1
3.	AFRAH MOHAMMED	IT	1
4.	CHNDANA YADAV	EEE	1
5.	MUSKAN PRIYA	EEE	1
6.	P KEERTHI	EEE	1
7.	M AKANKSHA	EEE	1
8.	K HANILA	EEE	1
9.	MIR JAKEER UDDIN	IT	1
10.	S MUSTAU AHMED	EEE	1
11.	SOHAIL F SHAREEF	IT	1
12.	MD JAHEED HUSSAIN	IT	1
13.	P PUSHPALATHA	IT	1
14.	M POOJA	IT	1
15.	KIRAN KUMARI	IT	1
16.	A ABHISHEK	IT	1
17.	D ANUJ	IT	1
18.	B RAGHAVENDRA	IT	1
19.	H JEEVAN	EEE	1

K. Srinivas

MAHAVEER
INSTITUTE OF SCIENCE & TECHNOLOGY
Bandlaguda, Hyd 500 005.

Vysapuri, Bandlaguda Post, Keshavgiri,
Hyderabad-500 005, TELANGANA INDIA
Tel: 040-64596979,8978380692.
Fax: 040-24455003
E-mail: principal_mahaveer@gmail.com
Website: www.mist.ac.in.

MAHAVEER



Approved by AICTE, Affiliated to JNTUH, Hyd.

Dt:17/2/2019

EVENT NAME: SWAMI VIVEKANANDA AND THE RELEVANCE OF HIS MESSAGE IN THE 21ST CENTURY

Faculty Organizing Committee

S NO	NAME OF THE FACULTY	DESIGNATION	DEPT
1	Dr M Vasanthaxmi	ASSOCIATE PROFESSOR	CIVIL

K. Subi

PRINCIPAL
MAHAVEER
INSTITUTE OF SCIENCE & TECHNOLOGY
Bandlaguda Post, 500 005.

Vysapuri, Bandlaguda Post, Keshavgi,
Hyderabad-500 005, TELANGANA INDIA
Tel: 040-64596979, 8978380692
Fax: 040-24455003
E-mail: principal.mahaveer@gmail.com
Website: www.mist.ac.in,

MAHAVEER

Approved by AICTE, Affiliated to JNTUH, Hyd



INDEX

NSS REGULAR ACTIVITIES FOR THE AY 2019-20

S.NO	EVENT	DATE
1.	Loksabha election volunteering	12-04-2019
2.	Tobacco Free Pledge	31-05-2019
3.	INTERNATIONAL YOGA DAY	21-06-2019
4.	NSS Orientation Programme For First Year Students	05-08-2019
5.	Gandhi Padha Yathra On Independence Day	15-08 -2019
6.	Each One Plant One Tree Programme	20-08-2019
7.	Plantation Programme	21-08-2019
8.	Fit India Programme	29-08-2019
9.	Eco Friendly Ganesh Campaign	31-08-2019
10.	Dress code in campus NTV programme	20-09-2019
11.	Kill Cancer Elocution Competition In MIST Campus	25-09-2019
12.	Swacchata Action Plan Work Shop	27-09-2019
13.	Women Safety Programme	29-09-2019
14.	Gandhi jayanthi attended in JNTUH	02-10-2019
15.	Batukamma Celebrations	3-10-2019
16.	A Seminar On Be Fit And Being Healthy	18-10-2019
17.	Traditional day at MIST campus	26-10-19
18.	Unity Day At MIST Campus	31-10-2019
19.	GEO-SPIRIT For Earth Leadership District Level Programme	8-11-2019
20.	Attended WASH programme In JNTUH	21-11-2019
21.	Kill Cancer Programme Organized At JNTUH With ISCON	18-12-2019
22.	Participated In Megha Blood Donation Campus	18-12-2019
23.	Vivekananda Pushpanjali Programme	18-01-2020
24.	Be good do good -Ramakrishna math	23-01-2019
25.	National Voters Day Awareness Programme	25-01-2020
26.	Republic day	26-01-2020
27.	Traffic Awareness Programme In MIST Campus	5-03-2020

K. S. S. S.
PRINCIPAL
MAHAVEER
INSTITUTE OF SCIENCE & TECHNOLOGY
Bandlaguda, Hyderabad-500 005.

Vysapuri, Bandlaguda Post:Keshavgiri,
Hyderabad-500 005, TELANGANA INDIA
Tel: 040-64596979,8978380692,
Fax: 040-24455003
E-mail: principal.mahaveer@gmail.com,
Website: www.mist.ac.in,

MAHAVEER

Approved by AICTE, Affiliated to JNTUH,Hyd.



Date: 10-04-2019

CIRCULAR

Sub: Loksabha election volunteering

All the faculty members and students are here by informed that "Loksabha election volunteering" will be organised by NSS unit of Mahaveer Institute Of Science and Technology in Association with Mailardevpally police station is scheduled on **12th APRIL 2019** between 9.30AM to 2.00PM at various polling stations. Students, teaching and non-teaching staff members are requested to participate this event.

Copy to:

All Hod's, Principal
polytechnic, Exam
Branch incharge,
Librarian

PRINCIPAL

PRINCIPAL
MAHAVEER
INSTITUTE OF SCIENCE & TECHNOLOGY
Bandlaguda, Hyd-500 005.

PRINCIPAL
MAHAVEER
INSTITUTE OF SCIENCE & TECHNOLOGY
Bandlaguda, Hyd-500 005.

Vysapuri, Bandlaguda Post:Keshavgi,
Hyderabad-500 005, TELANGANA INDIA
Tel: 040-64596979,8978380692,
Fax: 040-24455003
E-mail: principal.mahaveer@gmail.com
Website: www.mist.ac.in.

MAHAVEER
INSTITUTE OF SCIENCE & TECHNOLOGY
Approved by AICTE, Affiliated to JNTUH,Hyd.



1	Activity	Loksabha election volunteering	12-04-2019
---	----------	--------------------------------	------------

In Loksabha elections of Ranga Reddy district 70 students worked as volunteers in association with Mailardavepalli Police station in several polling stations to help the voters for better polling in the polling stations, students awarded with **certificates**.



Handwritten signature
PRINCIPAL
MAHAVEER

Vysapuri, Bandlaguda Post Keshavgiri,
Hyderabad-500 005, TELANGANA INDIA
Tel: 040-84596979,8978380692.
Fax: 040-24455003
E-mail: principal.mahaveer@gmail.com
Website: www.mist.ac.in,

MAHAVEER

Approved by AICTE, Affiliated to JNTUH,Hyd



19.	GATTU SHIVA SAI GUPTA	ECE	III
20.	GUMMI VISHWA TEJ REDDY	ECE	III
21.	KOVURU ARJUN	ECE	II
22.	VELAMALA NARENDRA	ECE	II
23.	DARNA SAI NAVEEN KUMAR	CSE	IV
24.	PEESARI PRASHANTH	CSE	IV
25.	VARKALA NAYANA REDDY	CSE	III
26.	BADUGU VARUN	CSE	I
27.	M VINAY KUMAR REDDY	CSE	I
28.	PADMAVATHI PALIWAL	CSE	I
29.	CHILAKAPATI SANJAY BHARADWAJ	IT	I
30.	BODEPUDI RISHINATH	IT	I
31.	THIRUNAGARI JAYANTH	IT	I

K. Srinivas
PRINCIPAL
MAHAVEER
INSTITUTE OF SCIENCE & TECHNOLOGY
Bandlaguda, Hyd-500 005.

Vysapuri, Bandlaguda Post:Keshavglri,
Hyderabad-500 005, TELANGANA INDIA
Tel: 040-64596979,8978380692,
Fax: 040-24455003
E-mail: principal.mahaveer@gmail.com
Website: www.mist.ac.in,

MAHAVEER

Approved by AICTE, Affiliated to JNTUH,Hyd.



Dt: 12-04-2019

Event Name:Loksabha election volunteering

Student Participation List

S NO	STUDENT NAME	BRANCH	YEAR
1.	MADARAM GOURISHANKAR	AERO	III
2.	GUNTURI HRUSHIKESH	AERO	III
3.	MEGAVATH RAJU	AERO	IV
4.	CHETPELLY SANJEEV	CIVIL	IV
5.	NUNAVATH NAVEENRAM	CIVIL	IV
6.	RAYKODE NIKHIL	CIVIL	III
7.	RATHLAVATH BALRAJ	CIVIL	II
8.	SANDA DEEPAK KUMAR	EEE	IV
9.	HATKAR JEEVAN	EEE	IV
10.	MALOTH PAVANKUMAR	EEE	IV
11.	KATTOJI SATYA SAI	EEE	II
12.	B ABHILASH CHARY	MECH	III
13.	MOHAMMED OWAIS KHAN	MECH	III
14.	SAHADEVUDU BALAJI	MECH	III
15.	BADDENAPELLY ADITHYA	ECE	IV
16.	EPURI RAKESH NETHA	ECE	IV
17.	KOTHA HARSHINI	ECE	III
18.	VOBILISHETTY ABHINAV	ECE	III

Vysapuri, Bandlaguda Post:Keshavgiri,
Hyderabad-500 005, TELANGANA INDIA
Tel: 040-64596979,8978380692.
Fax: 040-24455003
E-mail: principal.mahaveer@gmail.com,
Website: www.mlst.ac.in,

MAHAVEER

Approved by AICTE, Affiliated to JNTUH,Hyd.



Date: 29-05-2019

CIRCULAR

Sub: Tobacco Free Pledge

All the faculty members and students are here by informed that "Tobacco Free Pledge" will be organised by NSS unit of Mahaveer Institute Of Science and Technology is scheduled on 31ST MAY 2019 between 9.30AM to 2.00PM in our college campus. Students, teaching and non-teaching staff members are requested to participate this event.

Copy to:

All Hod's, Principal
polytechnic, Exam
Branch incharge,
Librarian

Kshul

PRINCIPAL

PRINCIPAL
MAHAVEER
INSTITUTE OF SCIENCE & TECHNOLOGY
Bandlaguda, Hyd-500 005.

Kshul

PRINCIPAL
MAHAVEER
INSTITUTE OF SCIENCE & TECHNOLOGY
Bandlaguda, Hyd-500 005.

Vysapuri, Bandlaguda Post:Keshavgiri,
Hyderabad-500 005, TELANGANA INDIA
Tel: 040-64596979,8978380692,
Fax: 040-24455003
E-mail: principal.mahaveer@gmail.com
Website: www.mist.ac.in.

MAHAVEER
INSTITUTE OF SCIENCE & TECHNOLOGY
Approved by AICTE, Affiliated to JNTUH,Hyd.



2	Activity	Tobacco Free Pledge	31-05-2019
---	----------	---------------------	------------

This programme was organized at *MIST* campus on the occasion of *World No Tobacco day* on *31 may 2019* by the instructions given by State *NSS Coordinator jntuh DR.G Narsimha*, this Tobacco pledge was conducted in all the classrooms at *MIST* Campus, and students were committed to keep themselves desist from tobacco as a *World No Tobacco day*.



Kant
PRINCIPAL
MAHAVEER

Vysapuri, Bandlaguda Post:Keshavgirl,
Hyderabad-500 005, TELANGANA INDIA
Tel: 040-64596979,8978380692.
Fax: 040-24455003
E-mail: principal.mahaveer@gmail.com
Website: www.mist.ac.in,

MAHAVEER

Approved by AICTE, Affiliated to JNTUH,Hyd.



Dt: 31-05-2019

Event Name: Tobacco Free Pledge

Student Organizing Committee

S NO	STUDENT NAME	BRANCH	Year
1.	ASHALA GANESH	ECE	III
2.	CHINTHAKULA AKHIL	ECE	III
3.	DESHWAL VINEET	EEE	III
4.	J NIKITHA	CSE	III
5.	CHENNUPATI CHAITANYA	IT	III
6.	BISHETTY SAI CHARAN	CSE	III
7	RAVULA HEMANTH KUMAR	MECH	III

Faculty Organizing Committe

S NO	NAME OF THE FACULTY	DESIGNATION	DEPT
1	Dr M Vasanthaxmi	ASSOCIATE PROFERSSOR	CIVIL

Keshav
PRINCIPAL

Vysapuri, Bandlaguda Post: Keshavgiri,
Hyderabad-500 005, TELANGANA INDIA
Tel: 040-64596979, 8978380692,
Fax: 040-24455003
E-mail: principal.mahaveer@gmail.com,
Website: www.mist.ac.in,

MAHAVEER

Approved by AICTE, Affiliated to JNTUH, Hyd.



Date: 20-06-19

CIRCULAR

Sub: INTERNATIONAL YOGA DAY

All the faculty members and students are here by informed that "INTERNATIONAL YOGA DAY" will be organised by NSS unit of Mahaveer Institute Of Science and Technology is scheduled on 21ST JUNE 2019 between 9.30AM to 2.00PM in our college campus. Students, teaching and non-teaching staff members are requested to participate this event.

Copy to:

All Hod's, Principal
polytechnic, Exam
Branch incharge,
Librarian

PRINCIPAL

PRINCIPAL
MAHAVEER
INSTITUTE OF SCIENCE & TECHNOLOGY
Bandlaguda, Hyd-500 005.

PRINCIPAL
MAHAVEER
INSTITUTE OF SCIENCE & TECHNOLOGY
Bandlaguda, Hyd-500 005.

Vysapuri, Bandlaguda Post:Keshavgi,
Hyderabad-500 005, TELANGANA INDIA
Tel: 040-64596979,8978380692,
Fax: 040-24455003
E-mail: principal.mahaveer@gmail.com
Website: www.mist.ac.in.

MAHAVEER
INSTITUTE OF SCIENCE & TECHNOLOGY
Approved by AICTE, Affiliated to JNTUH,Hyd.



3	Activity	INTERNATIONAL YOGA DAY	21-06-19
---	----------	------------------------	----------

International Yoga day conducted in MIST campus auditorium with the help of *ISHA yoga, Coimbatore* resource person *Narender kumar* along with one volunteer from ISHA. Nearly 400 students were trained in two batches along with faculty members. By the end of this programme Narender kumar was solicited with Dr. Jaspal kumar HOD ECE.



Keshavgi
M. I. S. T.
INSTITUTE OF SCIENCE & TECHNOLOGY

Vysapuri, Bandlaguda Post: Keshavgiri,
Hyderabad-500 005, TELANGANA INDIA
Tel: 040-64596979, 8978380692,
Fax: 040-24455003
E-mail: principal.mahaveer@gmail.com
Website: www.mist.ac.in,

MAHAVEER

Approved by AICTE, Affiliated to JNTU(H), Hyd



Dt: 21-06-19

Event Name: INTERNATIONAL YOGA DAY

Student Organizing Committee

S NO	STUDENT NAME	BRANCH	Year
1.	DEVI SHRI PRASAD PATANGI	MECH	IV
2.	PUNEET RAJ CHAVAN	MECH	IV
3.	R VAISHNAVI	IT	IV
4.	RAVULA SRAVANI	CSE	IV
5.	CHEKATAMALLA VAMSHI CHANDRA SHEKAR	CSE	IV
6.	MANGILIPPELly SAI KUMAR		IV
7	JADAV SATHISH	EEE	IV
8	M S S VYBHAV	CSE	III
9	POLA ROHITH KUMAR	AERO	III

Faculty Organizing Committee

S NO	NAME OF THE FACULTY	DESIGNATION	DEPT
1	DR M VASANTHALAXMI	ASSOCIATE PROFESSOR	CIVIL
2	NATRAJ GUDLA	Samskruthi foundation member	

K. S. S.

PRINCIPAL
MAHAVEER
INSTITUTE OF TECHNOLOGY

Vysapuri, Bandlaguda Post:Keshavgiri,
Hyderabad-500 005, TELANGANA INDIA
Tel: 040-64596979,8978380692
Fax: 040-24455003
E-mail: principal.mahaveer@gmail.com,
Website: www.mist.ac.in.

MAHAVEER

Approved by AICTE, Affiliated to JNTU.Hydr.



Date: 03-08-2019

CIRCULAR

Sub: NSS Orientation Programme For First Year Students

All the faculty members and students are here by informed that "NSS Orientation Programme For First Year Students" will be organised by NSS unit of Mahaveer Institute Of Science and Technology is scheduled on 05 AUGUST 2019 between 9.30AM to 2.00PM in our college campus. Students, teaching and non-teaching staff members are requested to participate this event.

Copy to:

All Hod's, Principal
polytechnic, Exam
Branch incharge,
Librarian

PRINCIPAL
MAHAVEER
INSTITUTE OF SCIENCE & TECHNOLOGY
Bandlaguda, Hyd-500 005



PRINCIPAL

PRINCIPAL
MAHAVEER
INSTITUTE OF SCIENCE & TECHNOLOGY
Bandlaguda, Hyd-500 005.

Vysapuri, Bandlaguda Post:Keshavgiri,
Hyderabad-500 005, TELANGANA INDIA
Tel: 040-64596979,8978380692,
Fax: 040-24455003
E-mail: principal.mahaveer@gmail.com
Website: www.mist.ac.in.

MAHAVEER
INSTITUTE OF SCIENCE & TECHNOLOGY
Approved by AICTE, Affiliated to JNTUH,Hyd.



4	Activity	NSS Orientation Programme For First Year Students	05-08-2019
---	----------	---	------------

Every year we conducted NSS orientation program for first year students of all the branches from Mahaveer Institution by NSS UNIT to create the awareness of NSS Programmes. The guest of this program was *TR Ganesh* Sr faculty VIHE RK Math, Domalguda, Hyderabad, Topic of this program was *Your Transformation Can Transform The Nation*, after completion of this program students were motivated very well.



Kanhi
PRINCIPAL
MAHAVEER
INSTITUTE OF SCIENCE & TECHNOLOGY
Bandlaguda, Hyd-500 005.

Vysapuri, Bandlaguda Post, Keshavgiri,
Hyderabad-500 005, TELANGANA INDIA
Tel: 040-64596979,8978380692,
Fax: 040-24455003
E-mail: principal.mahaveer@gmail.com
Website: www.mist.ac.in,

MAHAVEER

Approved by AICTE, Affiliated to JNTUH, Hyd



Dt: 05-08-2019

Event Name: NSS Orientation Programme For First Year Students

Student Organizing Committee

S NO	STUDENT NAME	BRANCH	YEAR
1.	N CHAITANYA	CSE	III
2.	S MAHENDER REDDY	CSE	III
3.	G ASHOK	CSE	III
4.	T LATHA	CSE	III
5.	G MAHESWARI	CSE	III
6.	K SRUTEJA	CSE	III
7	GURRAM RAJESH	CSE	III
8	AFRIN	CSE	III
9	POLAM RETHIMAREDDY	CSE	III

Faculty Organizing Committee

S NO	NAME OF THE FACULTY	DESIGNATION	DEPT
1	Dr M Vasanthaxmi	ASSOCIATE PROFESSOR	CIVIL

K. Srinivas
PRINCIPAL
MAHAVEER
INSTITUTE OF TECHNOLOGY
HYDERABAD-500 005.

Vysapuri, Bandlaguda Post: Keshavgiri,
Hyderabad-500 005, TELANGANA INDIA
Tel: 040-64596979, 8978380692
Fax: 040-24455003
E-mail: principal.mahaveer@gmail.com,
Website: www.mist.ac.in,

MAHAVEER

Approved by AICTE, Affiliated to JNTUH, Hyd.



Date: 13-08 -2019

CIRCULAR

Sub: Gandhi Padha Yathra On Independence Day

All the faculty members and students are here by informed that "Gandhi Padha Yathra On Independence Day" will be organised by NSS unit of Mahaveer Institute Of Science and Technology is scheduled on 15th AUGUST 2019 between 9.30AM to 2.00PM from MIST campus to Mailardevpally . Students, teaching and non-teaching staff members are requested to participate this event.

Copy to:
All Hod's, Principal
polytechnic, Exam
Branch incharge,
Librarian

PRINCIPAL
MAHAVEER
INSTITUTE OF SCIENCE & TECHNOLOGY
Bandlaguda, Hyd-500 005.

PRINCIPAL

PRINCIPAL
MAHAVEER
INSTITUTE OF SCIENCE & TECHNOLOGY
Bandlaguda, Hyd-500 005.

Vysapuri, Bandlaguda Post:Keshavgi,
Hyderabad-500 005, TELANGANA INDIA
Tel: 040-64596979,8978380692.
Fax: 040-24455003
E-mail: principal_mahaveer@gmail.com
Website: www.mist.ac.in.

MAHAVEER
INSTITUTE OF SCIENCE & TECHNOLOGY
Approved by AICTE, Affiliated to JNTUH,Hyd.



5	Activity	Gandhi Padha Yathra On Independence Day	15-08 -2019
---	----------	---	-------------

As part of 150 birth anniversary of Mahatma Gandhi our college NSS Unit conducted rally to create awarness on gandhiji ambitions on Independence Day from *MIST campus to Mailardevpally* nearly *100 students* were participated in thi rally along with *NSS program officer Dr.M Vasantha lakshmi*.

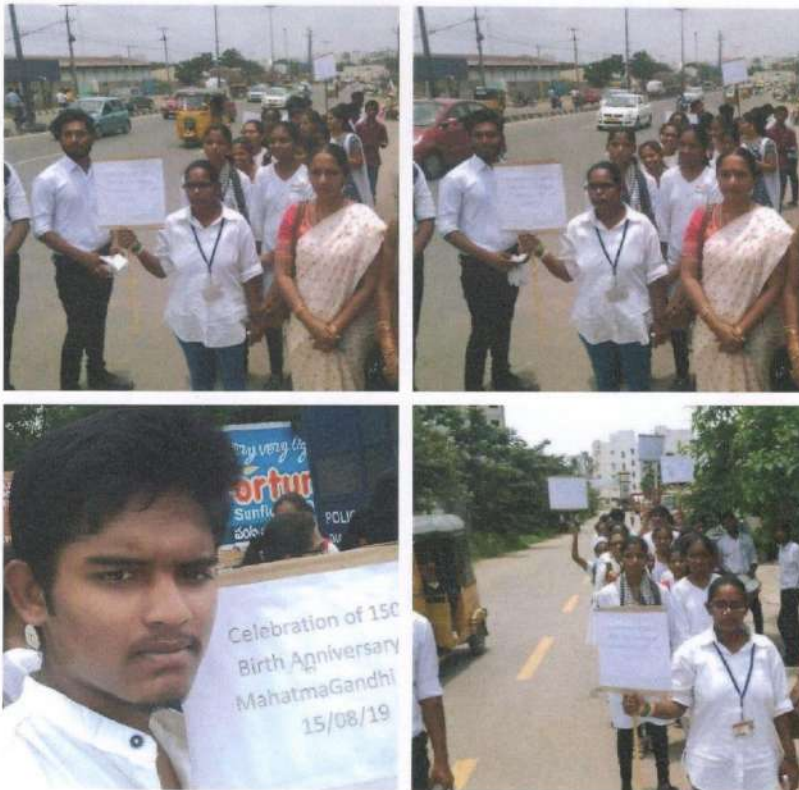

Mahaveer
PRINCIPAL
MAHAVEER

Vysapuri, Bandlaguda Post: Keshavgi,
Hyderabad-500 005, TELANGANA INDIA
Tel: 040-84596979,8978380692,
Fax: 040-24455003
E-mail: principal.mahaveer@gmail.com
Website: www.mist.ac.in,

MAHAVEER

Approved by AICTE, Affiliated to JNTUH, Hyd



Dt: 15-08 -2019

Event Name: GandhiPadhaYathra On Independence Day

Student Organizing Committee

S NO	STUDENT NAME	BRANCH	YEAR
1.	DHARAVATH THARUN	ECE	IV
2.	JAGIDI VAMSHIKRISHNA	ECE	IV
3.	CHOLLETI KAVYA	ECE	IV
4.	J NIKITHA	CSE	IV
5.	JAKKULA VAMSHI	CSE	IV
6.	KOVA SAIKUMAR	MECH	IV
7	SAMBARU VIKAS	IT	III
8	DAMALLA RAKESH	CIVIL	III

Faculty Organizing Committee

S NO	NAME OF THE FACULTY	DESIGNATION	DEPT
1	Dr M Vasanthaxmi	ASSOCIATE PROFERSOR	CIVIL

Keshu

PRINCIPAL
MAHAVEER

Vysapuri, Bandlaguda Post:Keshavgirl,
Hyderabad-500 005, TELANGANA INDIA
Tel: 040-64596979,8978380692,
Fax: 040-24455003
E-mail: principal.mahaveer@gmail.com
Website: www.mist.ac.in,

MAHAVEER

Approved by AICTE. Affiliated to JNTUH.Hyd



90	GANDRA DEEKSHITH RAO	EEE	II
91	GUNUGANTI SPOORTHII	EEE	II
92	MOGILI MANJULA	EEE	II
93	BHUKYA VAMSHI	MECH	II
94	THODETI REVANTH	MECH	II
95	ARUKULA MANASA	ECE	II
96	BURRA HARSHITHA YADAV	CSE	II
97	MUSUNURU KAMAL NADH	CSE	II
98	MANIKONDA ABHISHEK	CSE	II
99	PRANAY SHARMA	CSE	II
100	VUJJINI VIKITHA	CSE	II

Keshav

PRINCIPAL
MAHAVEER
INSTITUTE OF SCIENCE & TECHNOLOGY
Bandlaguda, Hyd-500 005.

Vysapuri, Bandlaguda Post: Keshavgiri,
Hyderabad-500 005, TELANGANA INDIA
Tel: 040-64596979, 8978380692.
Fax: 040-24455003
E-mail: principal.mahaveer@gmail.com
Website: www.mist.ac.in,

MAHAVEER

Approved by AICTE. Affiliated to JNTUH, Hyd



67	MANKENA PRUDHVIKIRAJ	MECH	III
68	MOHAMMED MOAZZAM ALI	MECH	III
69	BHUKYA RAJU	CIVIL	III
70	ESSAM KAVYA	CIVIL	III
71	GADIKOPPULA ROHITH VARMA	CIVIL	III
72	SIDDAMSETTI AVINASH	CIVIL	III
73	TURUKA PAVANI	CIVIL	III
74	ADIRE SPANDANA	AERO	III
75	GUGULOTH SAIKRISHNA	AERO	III
76	OJA NAGAVINAY	AERO	III
77	CHENCHU HARISH	CSE	III
78	LONE HARISH	CSE	III
79	SHAIK BHASHA	CSE	III
80	RAGULA REKHA	CSE	III
81	AKULA VARUN GOUD	CSE	III
82	BORRA SOMESHWAR REDDY	CSE	III
83	P LOKESH	CSE	III
84	THOTA PAVAN KALYAN	CSE	III
85	NADELLA JAHNAVI	CSE	III
86	SAMUDRALA SAITEJA	CSE	III
87	BODA RAJESH	CIVIL	II
88	JUVERIA MAHVEEN	CIVIL	II
89	N SHIVA SHANKER	CIVIL	II

K. S. S.

Vysapuri, Bandlaguda Post:Keshavgi,
Hyderabad-500 005, TELANGANA INDIA
Tel: 040-64596979,8978380692.

Fax: 040-24455003

E-mail: principal.mahaveer@gmail.com

Website: www.mist.ac.in,

MAHAVEER

Approved by AICTE, Affiliated to JNTUH,Hyd.



44	KOVA SAIKUMAR	MECH	IV
45	N SRIKANTH REDDY	MECH	IV
46	NALLA TEJASWI	MECH	IV
47	PATLOLLA PRASHANTH REDDY	MECH	IV
48	RAVULA HEMANTH KUMAR	MECH	IV
49	AMERINANI ANIL KUMAR	MECH	IV
50	KATPALLY SRENU REDDY	MECH	IV
51	KOMMU VENUGOPAL	MECH	IV
52	PYATA PRASHANTH KUMAR	MECH	IV
53	ARAVIND JOSHI	ECE	III
54	BOORAM SAI ROSHAN	ECE	III
55	NAGAPURI RAHUL	ECE	III
56	VISLAVATH SHIVA	ECE	III
57	BAINGAR HARI PRASAD	IT	III
58	TUMMA NISHANTH KUMAR	IT	III
59	PALLE SRIKANTH	IT	III
60	MIRYALA MOUNIKA	IT	III
61	GADILA SAI KIRAN	EEE	III
62	KATAKAM GOPI	EEE	III
63	GULLA SRILATHA	EEE	III
64	V SWATHI	EEE	III
65	AILNENI HARSHITH	MECH	III
66	DANDU SANJEEV	MECH	III



Vysapuri, Bandlaguda Post, Keshavgiri,
Hyderabad-500 005, TELANGANA INDIA
Tel: 040-64596979, 8978380692,
Fax: 040-24455003
E-mail: principal.mahaveer@gmail.com
Website: www.mist.ac.in,

MAHAVEER

Approved by AICTE, Affiliated to JNTUH, Hyd



21.	RENDA RANJITH	IT	IV
22.	BADAM ABILASHI	CSE	IV
23.	GOPIREDDY ANKITH REDDY	CSE	IV
24.	MALKANNAGARI SRUJAY REDDY	CSE	IV
25.	MUDAVATH PAVAN KUMAR	CSE	IV
26.	PAPINENI MANOJ KUMAR	CSE	IV
27.	PEESU ANUDEEP	CSE	IV
28.	RIKKA VANDANA	CSE	IV
29.	NATHI ALEKYA	CSE	IV
30.	BOMMA NITIN	CSE	IV
31.	CHERUKU SAI KIRAN	CSE	IV
32.	MALOTHU RANJITH	CSE	IV
33.	MEREDDY APARNA	CSE	IV
34.	GADDAM SAI TEJA REDDY	CSE	IV
35.	KALAKONDA SAINATH	CSE	IV
36.	KARING DINESH	IT	IV
37.	PADALA NAVIKANTH CHARY	IT	IV
38.	PEDDISSETTY NAGA ANUSHA	IT	IV
39.	R KARTHIK KUMAR	IT	IV
40.	VATTIKUTI MAHESH	IT	IV
41.	VITTEDEI PAVAN REDDY	IT	IV
42.	JALLU ARAVIND KUMAR	MECH	IV
43.	KARAM VAMSIKRISHNA	MECH	IV

Handwritten signature

Vysapuri, Bandlaguda Post: Keshavgi,
Hyderabad-500 005, TELANGANA INDIA
Tel: 040-64596979, 8978380692.
Fax: 040-24455003
E-mail: principal.mahaveer@gmail.com
Website: www.mist.ac.in,

MAHAVEER

Approved by AICTE. Affiliated to JNTUH, Hyd



Dt: 15-08 -2019

Event Name: Gandhi Padha Yathra On Independence Day

Student Participation List

S NO	STUDENT NAME	BRANCH	YEAR
1.	ANAGOUNI SHIVANI GOUD	ECE	IV
2.	ANUMALA NAVEENKUMAR	ECE	IV
3.	DADIGE SANTHOSH KUMAR	ECE	IV
4.	G HARISH	ECE	IV
5.	GUGGILA CHANDANA	ECE	IV
6.	TINGRIKAR BHARATH RAJ	ECE	IV
7.	ANNABOINA SHALINI	ECE	IV
8.	BATTA SREE AMRUTH VAMSHI	ECE	IV
9.	CHALLA VARUN REDDY	ECE	IV
10.	MADASU AISHWARYA	ECE	IV
11.	NEELA JASHWANTH	ECE	IV
12.	SIMALI ROY CHOWDHURY	ECE	IV
13.	TATIKONDA PRIYANKA	ECE	IV
14.	TATIKONDA PRIYANKA	ECE	IV
15.	AKKALADEVI RAMYASRI	IT	IV
16.	BEJAWADA SANDEEP	IT	IV
17.	EEGA PRACHYUTH	IT	IV
18.	MEGAVATH PAVAN KUMAR	IT	IV
19.	MS MANSI DUBEY	IT	IV
20.	PITTALA PAVAN KALYAN	IT	IV

Vysapuri, Bandlaguda Post: Keshavgiri,
Hyderabad-500 005, TELANGANA INDIA
Tel: 040-64596979, 8978380692,
Fax: 040-24455003
E-mail: principal.mahaveer@gmail.com,
Website: www.mist.ac.in,

MAHAVEER



Approved by AICTE, Affiliated to JNTUH, Hyd.

Date: 19-08-2019

CIRCULAR

Sub: Each one plant one tree Programme

All the faculty members and students are here by informed that "Each one plant one tree Programme" will be organised by NSS unit of Mahaveer Institute Of Science and Technology is scheduled on 20ST AUGUST 2019 between 9.30AM to 2.00PM in our college campus. Students, teaching and non-teaching staff members are requested to participate this event.

PRINCIPAL

Copy to:
All Hod's, Principal
polytechnic, Exam
Branch incharge,
Librarian

PRINCIPAL
MAHAVEER
INSTITUTE OF SCIENCE & TECHNOLOGY
Bandlaguda, Hyd-500 005.

PRINCIPAL
MAHAVEER
INSTITUTE OF SCIENCE & TECHNOLOGY
Bandlaguda, Hyd-500 005.

Vysapuri, Bandlaguda Post:Keshavgiri,
Hyderabad-500 005, TELANGANA INDIA
Tel: 040-64596979,8978380692.
Fax: 040-24455003
E-mail: principal.mahaveer@gmail.com
Website: www.mist.ac.in.

MAHAVEER
INSTITUTE OF SCIENCE & TECHNOLOGY
Approved by AICTE, Affiliated to JNTUH,Hyd.



6	Activity	Each One Plant One Tree Programme	20-08-2019
---	----------	-----------------------------------	------------

This program was conducted on orientation day of first year students to spread the greenery in our surroundings, our college NSS Unit organized this program and NSS volunteers distributed the plants in our college campus to all the parents who attended orientation programme along with *NSS Programme officer DR.M Vasantha lakshmi*.



Kanika
PRINCIPAL

Vysapuri, Bandlaguda Post:Keshavgiri,
Hyderabad-500 005, TELANGANA INDIA
Tel: 040-64596979,8978380692,
Fax: 040-24455003
E-mail: principal.mahaveer@gmail.com
Website: www.mist.ac.in,

MAHAVEER

Approved by AICTE. Affiliated to JNTUH,Hyd



Dt:20-08-2019

Event Name: Each One Plant One Tree Programme

Student Organizing Committee

S NO	STUDENT NAME	BRANCH	YEAR
1	CHIPPE TEJASWI	ECE	III
2	CHIRLA AKHILA	IT	III
3	GADDAM JYOSHNA	IT	III
4	C PRASHANSHA	IT	III
5	TUMMA NISHANTH KUMAR	IT	III
6	CHENCHU HARISH	CSE	III
7	THADOJU MURALIKRISHNA	CSE	III
8	BORRA SOMESHWAR REDDY	CSE	III

Faculty Organizing Committee

S NO	NAME OF THE FACULTY	DESIGNATION	DEPT
1	Dr M Vasanthaxmi	ASSOCIATE PROFESSOR	CIVIL

Kishu
PRINCIPAL
MAHAVEER
INSTITUTE OF SCIENCE & TECHNOLOGY
Bandlaguda, Hyd-500 005.

Vysapuri, Bandlaguda Post Keshavnagar,
Hyderabad-500 005, TELANGANA INDIA
Tel: 040-64596979, 8978380662
Fax: 040-24455003
E-mail: principal.mahaveer@gmail.com,
Website: www.mist.ac.in.

MAHAVEER

Approved by AICTE, Affiliated to JNTU(H) Hyd



Date: 19/8/2019

CIRCULAR

Sub: PLANTATION PROGRAMME

All the faculty members and students are here by informed that "PLANTATION PROGRAMME" will be organised by NSS unit of Mahaveer Institute Of Science and Technology and instructed by JNTU(H) NSS CELL is scheduled on 21st AUGUST 2019 between 9.30AM to 3.00PM in our college campus. Students, teaching and non-teaching staff members are requested to participate this event.

Copy to:
All Hod's, Principal
polytechnic, Exam
Branch incharge,
Librarian

PRINCIPAL

PRINCIPAL
MAHAVEER
INSTITUTE OF SCIENCE & TECHNOLOGY
Bandlaguda, Hyd-500 005.

PRINCIPAL
MAHAVEER
INSTITUTE OF SCIENCE & TECHNOLOGY
Bandlaguda, Hyd-500 005.

Vysapuri, Bandlaguda Post:Keshavgiri,
Hyderabad-500 005, TELANGANA INDIA
Tel: 040-64596979,8978380692,
Fax: 040-24455003
E-mail: principal.mahaveer@gmail.com
Website: www.mist.ac.in.

MAHAVEER
INSTITUTE OF SCIENCE & TECHNOLOGY
Approved by AICTE, Affiliated to JNTUH,Hyd.



7	Activity	Plantation Programme	21-08-2019
---	----------	----------------------	------------

NSS volunteers of Mahaveer students organized this programme according to the instructions given by JNTUH NSS cell to organize the Haritha Haram programme along with *NSS programme officer Dr.M.Vasantha lakshmi* on 21/08/2019, students planted the trees on college campus. Theme of this programme is *Plantation Drive* a part of *One Student one Tree Initiative*.



K. Srinivas
PRINCIPAL
MAHAVEER

Vysapuri, Bandlaguda Post:Keshavgiri,
Hyderabad-500 005, TELANGANA INDIA
Tel: 040-64596979,8978380692.
Fax: 040-24455003
E-mail: principal.mahaveer@gmail.com,
Website: www.mist.ac.in,

MAHAVEER



Approved by AICTE, Affiliated to JNTUH,Hyd.

Date: 27-08-2019

CIRCULAR

Sub: Fit India movement

All the faculty members and students are here by informed that "Fit India movement" will be organised by NSS unit of Mahaveer Institute Of Science and Technology is scheduled on **29TH AUGUST 2019** between 9.30AM to 2.00PM in our college campus. Students, teaching and non-teaching staff members are requested to participate this event.

Copy to:

All Hod's, Principal
polytechnic, Exam
Branch incharge,
Librarian

PRINCIPAL

PRINCIPAL
MAHAVEER
INSTITUTE OF SCIENCE & TECHNOLOGY
Bandlaguda, Hyd-500 005.

PRINCIPAL
MAHAVEER
INSTITUTE OF SCIENCE & TECHNOLOGY
Bandlaguda, Hyd-500 005.

Vysapuri, Bandlaguda Post:Keshavgi,
Hyderabad-500 005, TELANGANA INDIA
Tel: 040-64596979,8978380692,
Fax: 040-24455003
E-mail: principal.mahaveer@gmail.com
Website: www.mist.ac.in.

MAHAVEER
INSTITUTE OF SCIENCE & TECHNOLOGY
Approved by AICTE, Affiliated to JNTUH,Hyd.



8	Activity	Fit India movement	29-08-2019
---	----------	--------------------	------------

Our college NSS unit organized *FIT INDIA* program in our college campus by the instructions given by Regional director of NSS Hyderabad, this program was organized to create awareness and motivate the people about *Fitness To Build A Clean And Healthy Nation*. All the faculty members and students were participated in this programme.



Kishore
PRINCIPAL

Vyakarni, Bandlaguda Post Keshavnagar,
Hyderabad-500 005, TELANGANA INDIA
Tel: 040-64596979, 8978380692
Fax: 040-24455003
E-mail: principal.mahaveer@gmail.com,
Website: www.mist.ac.in

MAHAVEER



Approved by AICTE, Affiliated to JNTUH, Hyd.

Date: 29-08-2019

CIRCULAR

Sub: Eco Friendly Ganesh Campaign

All the faculty members and students are hereby informed that "Eco Friendly Ganesh Campaign" will be organised by NSS unit of Mahaveer Institute Of Science and Technology is scheduled on 31ST AUGUST 2019 between 9.30AM to 2.00PM in our college campus. Students, teaching and non-teaching staff members are requested to participate this event.

Copy to:

All Hod's, Principal
polytechnic, Exam
Branch incharge,
Librarian

PRINCIPAL

PRINCIPAL
MAHAVEER
INSTITUTE OF SCIENCE & TECHNOLOGY
Bandlaguda, Hyd-500 005.

PRINCIPAL
MAHAVEER
INSTITUTE OF SCIENCE & TECHNOLOGY
Bandlaguda, Hyd-500 005.

Vysapuri, Bandlaguda Post:Keshavgiri,
Hyderabad-500 005, TELANGANA INDIA
Tel: 040-64596979,8978380692.
Fax: 040-24455003
E-mail: principal.mahaveer@gmail.com
Website: www.mist.ac.in.

MAHAVEER
INSTITUTE OF SCIENCE & TECHNOLOGY
Approved by AICTE, Affiliated to JNTUH,Hyd.



9	Activity	Eco Friendly Ganesh Campaign	31-08-2019
---	----------	------------------------------	------------

On the occasion of *Ganesh Chaturthi* to save the environment, our college NSS volunteers organized this program along with NSS program officer Dr.M Vasantha lakshmi conducted at MIST college campus on before day of Ganesh Chaturthi, ganesh idols were distributed to students and faculty members to celebrate Eco Friendly Ganesh Chaturthi.



K. Srinivas
PRINCIPAL
MAHAVEER

Vysapuri, Bandlaguda Post:Keshavgi, Hyderabad-500 005, TELANGANA INDIA
Tel: 040-64596979,8978380692,
Fax: 040-24455003
E-mail: principal.mahaveer@gmail.com
Website: www.mist.ac.in,

MAHAVEER

Approved by AICTE. Affiliated to JNTUH,Hyd



Dt:31-08-2019

Event Name: Eco Friendly Ganesh Campaign

ORGANIZING COMMITTEE

S NO	NAME OF THE FACULTY	DESIGNATION	DEPT
1	Dr M Vasanthaxmi	ASSOCIATE PROFESSOR	CIVIL

K. Subh

PRINCIPAL
MAHAVEER
INSTITUTE OF SCIENCE & TECHNOLOGY
Bandlaguda, Hyd-500 005.

Vysapuri, Bandlaguda Post: Keshavgirl,
Hyderabad-500 005, TELANGANA INDIA
Tel: 040-64596979,8978380692,
Fax: 040-24455003
E-mail: principal.mahaveer@gmail.com
Website: www.mist.ac.in,

MAHAVEER

Approved by AICTE, Affiliated to JNTUH,Hyd



Dt: 31-08-2019

Event Name: Eco Friendly Ganesh Campaign

STUDENT PARTICIPATION LIST

S NO	STUDENT NAME	BRANCH	YEAR
1	NADELLA JAINAVI	CSE	III
2	RIKKULA BHAVANI	CSE	III
3	VELDANDA VIKRAM KOUNDINYA	CSE	III
4	L MANIDEEP	ECE	III
5	ERUGU SAMPATH	AERO	III
6	DANDU SANJEEV	MECH	III
7	BANOTH RAMESH	ECE	III
8	K RAHUL	AERO	II
9	PREM SAI	CIVIL	II
10	K KARTHEEK	CIVIL	II
11	M VINAY	CSE	II
12	R KALYAN SAI	CSE	II
13	S VISHWATEJ	ECE	II
14	R VINEETH	ECE	II
15	E NAVEEN	EEE	II
16	M POOJA	IT	II

K. Srinivas

Vysapuri, Bandlaguda Post: Keshavgiri,
Hyderabad-500 005, TELANGANA INDIA
Tel: 040-64596979, 8978380692,
Fax: 040-24455003
E-mail: principal.mahaveer@gmail.com,
Website: www.mist.ac.in,

MAHAVEER



Approved by AICTE, Affiliated to JNTUH, Hyd.

Date: 18-09-2019

CIRCULAR

Sub: Dress code in campus NTV programme

All the faculty members and students are hereby informed that "Dress code in campus NTV programme" will be organised by NSS unit of Mahaveer Institute Of Science and Technology in Association with NTV CHANNEL is scheduled on 20TH SEPTEMBER 2019 between 9.30AM to 2.00PM at NTV office. Students, teaching and non-teaching staff members are requested to participate this event.

Copy to:

All Hod's, Principal
polytechnic, Exam
Branch incharge,
Librarian

PRINCIPAL

PRINCIPAL
MAHAVEER
INSTITUTE OF SCIENCE & TECHNOLOGY
Bandlaguda, Hyd-500 005

PRINCIPAL
MAHAVEER
INSTITUTE OF SCIENCE & TECHNOLOGY
Bandlaguda, Hyd-500 005

Vysapuri, Bandlaguda Post:Keshavgiri,
Hyderabad-500 005, TELANGANA INDIA
Tel: 040-64596979,8978380692,
Fax: 040-24455003
E-mail: principal.mahaveer@gmail.com
Website: www.mist.ac.in.

MAHAVEER
INSTITUTE OF SCIENCE & TECHNOLOGY
Approved by AICTE, Affiliated to JNTUH,Hyd.



10	Activity	Dress code in campus NTV programme	20-09-2019
----	----------	------------------------------------	------------

This programme was conducted by NTV channel, our college girl students were participated in this debate theme **Dress code in the campus** wearing the modern dress is not objectable but it does not harmful to us, it gives us protection and looks like dignified.



Kshalya
PRINCIPAL
MAHAVEER

Vysapuri, Bandlaguda Post: Keshavgiri,
Hyderabad-500 005, TELANGANA INDIA
Tel: 040-64596979, 8978380692.
Fax: 040-24455003
E-mail: principal.mahaveer@gmail.com
Website: www.mist.ac.in,

MAHAVEER

Approved by AICTE. Affiliated to JNTUH Hyd



Dt: 20-09-2019

Event Name: Dress code in campus NTV programme

Student Participation List

S NO	STUDENT NAME	BRANCH	YEAR
1	LAKSHMI PRASANNA	IT	I
2	VARSHITHA	IT	I
3	PRASANNA	MBA	II
4	SUSSANNA	ECE	II
5	PADMAVATHI PALIWAL	CSE	II
6	P SREEJA	CSE	II

Organizing Committee

S NO	NAME OF THE FACULTY	DESIGNATION	DEPT
1	Dr M Vasanthaxmi	ASSOCIATE PROFESSOR	CIVIL

K. S. S. S.

PRINCIPAL
MAHAVEER
INSTITUTE OF SCIENCE & TECHNOLOGY
Bandlaguda, Hyd-500 005.

Vysapuri, Bandlaguda Post:Keshavgiri,
Hyderabad-500 005, TELANGANA INDIA
Tel: 040-64596979,8978380692.
Fax: 040-24455003
E-mail: principal.mahaveer@gmail.com,
Website: www.mist.ac.in,

MAHAVEER



Approved by AICTE, Affiliated to JNTUH,Hyd.

Date: 23-09-2019

CIRCULAR

Sub: Kill Cancer Elocution Competition In MIST Campus

All the faculty members and students are here by informed that "Kill Cancer Elocution Competition In MIST Campus" will be organised by NSS unit of Mahaveer Institute Of Science and Technology is scheduled on 25TH SEPTEMBER 2019 between 9.30AM to 2.00PM in our college campus. Students, teaching and non-teaching staff members are requested to participate this event.

Copy to:

All Hod's, Principal
polytechnic, Exam
Branch incharge,
Librarian

PRINCIPAL

PRINCIPAL
MAHAVEER
INSTITUTE OF SCIENCE & TECHNOLOGY
Bandlaguda, Hyd-500 005.

PRINCIPAL
MAHAVEER
INSTITUTE OF SCIENCE & TECHNOLOGY
Bandlaguda, Hyd-500 005.

Vysapuri, Bandlaguda Post:Keshavgi,
Hyderabad-500 005, TELANGANA INDIA
Tel: 040-64596979,8978380692,
Fax: 040-24455003
E-mail: principal.mahaveer@gmail.com
Website: www.mist.ac.in.

MAHAVEER
INSTITUTE OF SCIENCE & TECHNOLOGY
Approved by AICTE, Affiliated to JNTUH,Hyd.



11	Activity	Kill Cancer Elocution Competition In MIST Campus	25-09-2019
----	----------	--	------------

This programme was organized at Mahaveer Institute and Science and Technology by *NSS unit MIST* on 25th September 2019, the judges of this programme were *Ch Swethambar* HOD department of CIVIL Engineering and *DR.M Vasanthalakshmi* NSS programme officer this programme was organized based on the guidelines given by state NSS unit cell, and ISKCON, 19 members were participated in this elocution competition, participation certificates were given to all participants, 4 members were selected for district level competition, this competition was conducted in the presence of two members of ISKCON representatives.



Kshalya
PRINCIPAL

Vysapuri, Bandlaguda Post Keshavgiri,
Hyderabad-500 005, TELANGANA INDIA
Tel: 040-64506979, 8978380692
Fax: 040-24455003
E-mail: principal_mahaveer@gmail.com
Website: www.mist.ac.in.

MAHAVEER

Approved by AICTE. Affiliated to JNTUH, Hyd



Dt: 25-09-2019

Event Name: Kill Cancer Elocution Competition In MIST Campus

ORGANIZING COMMITTEE

S NO	NAME OF THE FACULTY	DESIGNATION	DEPT
1	Dr M Vasanthalaxmi	ASSOCIATE PROFERSOR	CIVIL

PRINCIPAL
MAHAVEER
INSTITUTE OF TECHNOLOGY
Bandlaguda, Hyd-500 005.

Vysapuri, Bandlaguda Post:Keshavgi,
Hyderabad-500 005, TELANGANA INDIA
Tel: 040-64596979,8978380692,
Fax: 040-24455003
E-mail: principal.mahaveer@gmail.com
Website: www.mist.ac.in,

MAHAVEER

Approved by AICTE. Affiliated to JNTUH.Hyd



Dt:25-09-2019

Event Name: Kill Cancer Elocution Competition In MIST Campus

STUDENT PARTICIPATION LIST

S NO	STUDENT NAME	BRANCH	YEAR
1	JERIPOTHULA HARSHAVARDHAN MOURYA	CIVIL	I
2	BEJUGAM BHARGAV	ECE	I
3	DHARANI KARNAKANTI	ECE	I
4	PITTALA LAHARI	CSE	I
5	P ASHISH RAO	CSE	I
6	PABBOJU SAI CHAITANYA	CSE	I
7	RANGU SAIKIRAN	CSE	I
8	MANIKONDA ABHISHEK	CSE	I
9	SAIRI LAXMI PRASANNA	IT	I
10	GANDLA SAI SIDDHARTHA	IT	I
11	KATIPALLY SAMPATH REDDY	IT	I
12	GUMMI VISHWA TEJ REDDY	ECE	II
13	MUDUGANTI BHANUTEJA	ECE	II
14	P CHAITANYA	MECH	II
15	SUNKI REDDY RUTHVIK REDDY	MECH	II
16	GAJULA LOKESH KUMAR	EEE	II
17	SANGU VIJAYENDER REDDY	AERO	II
18	ABHISHEK KUMAR	AERO	II
19	M VINAY KUMAR REDDY	CSE	II

K. Sankar

1000 005-040 64596979
Bandlaguda Post, Vysapuri

Vysapuri, Bandlaguda Post Keshavgiri,
Hyderabad-500 005, TELANGANA INDIA
Tel: 040-64596979, 8978380692
Fax: 040-24485003
E-mail: principal.mahaveer@gmail.com,
Website: www.mist.ac.in,

MAHAVEER



Approved by AICTE, Affiliated to JNTUH, Hyd.

Date: 25-09-2019

CIRCULAR

Sub: Swacchata Action Plan Work Shop

All the faculty members and students are here by informed that "Swacchata Action Plan Work Shop" will be organised by NSS unit of Mahaveer Institute Of Science and Technology is scheduled on 27TH SEPTEMBER 2019 between 9.30AM to 2.00PM in our college campus. teaching staff members are requested to participate this event.

Copy to:

All Hod's, Principal
polytechnic, Exam
Branch incharge,
Librarian

PRINCIPAL

PRINCIPAL
MAHAVEER
INSTITUTE OF SCIENCE & TECHNOLOGY
Bandlaguda, Hyd-500 005.

PRINCIPAL
MAHAVEER
INSTITUTE OF SCIENCE & TECHNOLOGY
Bandlaguda, Hyd-500 005.

Vysapuri, Bandlaguda Post:Keshavgi,
Hyderabad-500 005, TELANGANA INDIA
Tel: 040-64596979,8978380692,
Fax: 040-24455003
E-mail: principal_mahaveer@gmail.com
Website: www.mist.ac.in.

MAHAVEER
INSTITUTE OF SCIENCE & TECHNOLOGY
Approved by AICTE, Affiliated to JNTUH,Hyd.



12	Activity	Swacchata Action Plan Work Shop	27-09-2019
----	----------	---------------------------------	------------

This is a district level faculty development programme organized in the MIST campus mini seminar hall conducted by *MGNCRE*, resource person was *T Sandhya*, this is a two days FDP, for this programme other college faculty members were participated along with NSS programme coordinator *Dr.M vasantha lakshmi* and MIST faculty members. At the end of this workshop Sri S. Surender Reddy garu Secretary of MIST presented a memento to the Resource person and certificates were distributed to all the faculty members who were participated in this workshop.



K. S. S. S.
PRINCIPAL
MAHAVEER

Vysapuri, Bandlaguda Post Keshavpuri,
Hyderabad-500 005, TELANGANA INDIA
Tel: 040-64596979,8978380892,
Fax: 040-24455003
E-mail: principal.mahaveer@gmail.com
Website: www.mist.ac.in,

MAHAVEER

Approved by AICTE, Affiliated to JNTUH, Hyd



Dt:27-09-2019

Event Name: Swacchata Action Plan Work Shop

Organizing Committee

S NO	NAME OF THE FACULTY	DESIGNATION	DEPT
1	Dr. M Vasanthalakshmi	ASSOCIATE PROFESSOR	CIVIL

PRINCIPAL
P. MAHAVEER
INSTITUTE OF SCIENCE & TECHNOLOGY
Bandlaguda, Hyd 500 005.

Vysapuri, Bandlaguda Post:Keshavgiri,
Hyderabad-500 005, TELANGANA INDIA
Tel: 040-64596979,8978380692,
Fax: 040-24455003
E-mail: principal.mahaveer@gmail.com
Website: www.mist.ac.in,

MAHAVEER

Approved by AICTE, Affiliated to JNTUH,Hyd.



20	RAMAVATH HUSSAIN	EEE	AARM
21	B SHRAVAN KUMAR	MECH	AARM
22	B YELLAIAH	DEGREE	MIST

Kshalya

PRINCIPAL
MAHAVEER
INSTITUTE OF SCIENCE & TECHNOLOGY
Bandlaguda, Hyd-500 005.

Vysapuri, Bandlaguda Post:Keshavgirl,
Hyderabad-500 005, TELANGANA INDIA
Tel: 040-64596979,8978380692,
Fax: 040-24455003
E-mail: principal.mahaveer@gmail.com
Website: www.mist.ac.in,

MAHAVEER

Approved by AICTE, Affiliated to JNTUH,Hyd



Dt:27-09-2019

Event Name: Swacchata Action Plan Work Shop

FACULTY PARTICIPATION LIST

S NO	NAME OF THE FACULTY	BRANCH	College
1	N RAVI KUMAR	ECE	MIST
2	R PRABHAKAR	ECE	MIST
3	B SRINU	ECE	MIST
4	K GIRIBABU	CSE	MIST
5	MD SIDDIQUI	CSE	MIST
6	V NARESH KUMAR	IT	MIST
7	G PREM KUMAR REDDY	EEE	MIST
8	A MAHESH KUMAR	EEE	MIST
9	G JYOTHI	EEE	MIST
10	THIRUPATHIAIAH	AERO	MIST
11	MD SAZZAD	MECH	MIST
12	B BHARATH KUMAR	MECH	MIST
13	L RAJESH GOUD	MBA	MIST
14	PANASA ANIL	CIVIL	MIST
15	DR M VASANTHA LAXMI	CIVIL	MIST
16	P SRINIVAS KUMAR	H&S	MIST
17	A MANASA	CSE	AARM
18	G SOWMYA	ECE	AARM
19	K RADHIKA	H&S	AARM

Kanby

Vysapuri, Bandlaguda Post: Keshavgiri,
Hyderabad-500 005, TELANGANA INDIA
Tel: 040-64596979, 8978380692
Fax: 040-24455003
E-mail: principal.mahaveer@gmail.com,
Website: www.mist.ac.in,

MAHAVEER

Approved by AICTE. Affiliated to JNTUH, Hyd.



Date: 27-09-2019

CIRCULAR

Sub: Women Safety Programme

All the faculty members and students are hereby informed that "Women Safety Programme" will be organised by NSS unit of Mahaveer Institute Of Science and Technology in Association with VANITHA TV is scheduled on 28TH SEPTEMBER 2019 between 9.30AM to 2.00PM in our college campus. Students, teaching and non-teaching staff members are requested to participate this event.

Copy to:

All Hod's, Principal
polytechnic, Exam
Branch incharge,
Librarian

PRINCIPAL

PRINCIPAL
MAHAVEER
INSTITUTE OF SCIENCE & TECHNOLOGY
Bandlaguda, Hyd-500 005.

PRINCIPAL
MAHAVEER
INSTITUTE OF SCIENCE & TECHNOLOGY
Bandlaguda, Hyd-500 005.

Vysapuri, Bandlaguda Post:Keshavgiri,
Hyderabad-500 005, TELANGANA INDIA
Tel: 040-64596979,8978380692,
Fax: 040-24455003
E-mail: principal.mahaveer@gmail.com
Website: www.mist.ac.in.

MAHAVEER
INSTITUTE OF SCIENCE & TECHNOLOGY
Approved by AICTE, Affiliated to JNTUH,Hyd.



13	Activity	Women Safety Programme	29-09-2019
----	----------	------------------------	------------

This programme was organized by *Vanitha Tv* at Mahaveer Institute of Science and Technology On 29/9/2019, The guest of this program was *Shikha Goel IPS Addl. CP Crimes and SIT*, Hyderabad. For this programme Our college Chairmen *Sri S.Jayalkshmi garu* NSS programme officer *Dr.M.Vasantha lakshmi* and all girls students teaching and non technig women faculty were participated. Shikha madam gave valuable suggestions to the girls students and All lady faculty members regarding Safty and Security.



Kshama
PRINCIPAL
MAHAVEER
INSTITUTE OF SCIENCE & TECHNOLOGY

Vysapuri, Bandlaguda Post:Keshavgiri,
Hyderabad-500 005, TELANGANA INDIA
Tel: 040-64596979,8978380692,
Fax: 040-24455003
E-mail: principal.mahaveer@gmail.com
Website: www.mlst.ac.in,

MAHAVEER



Approved by AICTE. Affiliated to JNTUH,Hyd.

Dt:29-09-2019

Event Name: Women Safety Programme

Organizing Committee

S NO	NAME OF THE FACULTY	DESIGNATION	DEPT
1	Dr M Vasanthaxmi	ASSOCIATE PROFERSOR	CIVIL
2	VANITHA TV		

K. S. S. S.

PRINCIPAL
MAHAVEER
INSTITUTE OF SCIENCE & TECHNOLOGY
Bandlaguda, Hyd-500 005.

Vyasapur, Bandlaguda Post, Keshavnagar,
Hyderabad-500 005, TELANGANA INDIA
Tel: 040-24488070, 8970380009
Fax: 040-24488003
E-mail: principal.mahaveer@gmail.com,
Website: www.mist.ac.in

MAHAVEER



Approved by AICTE, Affiliated to JNTU(Hydr)

Date: 01-10-2019

CIRCULAR

Sub: Gandhi jayanthi attended in JNTUH

All the faculty members and students are here by informed that "Gandhi jayanthi attended in JNTUH" will be organised by NSS unit of Mahaveer Institute Of Science and Technology in Association with jntuh is scheduled on 2ND OCTOBER 2019 between 9.30AM to 2.00PM in JNTUH KUKATPALLY. Students, teaching and non-teaching staff members are requested to participate this event.

PRINCIPAL

Copy to:

All Hod's, Principal
polytechnic, Exam
Branch incharge,
Librarian

PRINCIPAL
MAHAVEER
INSTITUTE OF SCIENCE & TECHNOLOGY
Bandlaguda, Hyd-500 005.

PRINCIPAL
MAHAVEER
INSTITUTE OF SCIENCE & TECHNOLOGY
Bandlaguda, Hyd-500 005.

Vysapuri, Bandlaguda Post:Keshavgi,
Hyderabad-500 005, TELANGANA INDIA
Tel: 040-64596979,8978380692,
Fax: 040-24455003
E-mail: principal.mahaveer@gmail.com
Website: www.mist.ac.in.

MAHAVEER
INSTITUTE OF SCIENCE & TECHNOLOGY
Approved by AICTE, Affiliated to JNTUH,Hyd.



14	Activity	Gandhi jayanthi attended in JNTUH	02-10-2019
----	----------	-----------------------------------	------------

The JNTUH organized 150 years of Mahatma Gandhi Birth Anniversary celebrations at JN auditorium on 2nd october 2019, the theme of this programme was *Mega NSS Ganhian Youth Conclave* with 1000 NSS volunteers at JNTUH, for this programme 20 students and NSS programme officer of Mahaveer Institute of Science and technolgy were participated with Khadhi dress/white dress.



K. S. S. S.
PRINCIPAL
MAHAVEER

Vysapur, Bandlaguda Post Keshavnagar,
Hyderabad-500 005, TELANGANA INDIA
Tel: 040-64596979,8978380692,
Fax: 040-24455003
E-mail: principal.mshaveer@gmail.com
Website: www.mist.ac.in,

MAHAVEER

Approved by AICTE, Affiliated to JNTUH,Hyd.



Dt:2-10-2019

Event Name: Gandhi Jayanthi Attended in JNTUH

Organizing Committee

S NO	NAME OF THE FACULTY	DESIGNATION	DEPT
1	Dr M Vasanthalakshmi	ASSOCIATE PROFESSOR	CIVIL

PRINCIPAL
MAHAVEER
INSTITUTE OF SCIENCE & TECHNOLOGY
Bandlaguda, Hyd-500 005.

Vysapuri, Bandlaguda Post:Keshavgi,
Hyderabad-500 005, TELANGANA INDIA
Tel: 040-64596979,8978380692,
Fax: 040-24455003
E-mail: principal.mahaveer@gmail.com
Website: www.mist.ac.in,

MAHAVEER

Approved by AICTE, Affiliated to JNTUH,Hyd.



S NO	STUDENT NAME	BRANCH	YEAR
21	GANECHARY SHREYA	CSE	III
22	BAIMUTHAKA TRIVENI	CSE	III
23	BORRA SOMESHWAR REDDY	IT	III
24	JOY JARUSHA	CSE	II
25	PADMAVATHI PALIWAL	CSE	II
26	M VINAY	CSE	II
27	K. RAMYA	CSE	II
28	R KALYAN SAI	CSE	II
29	G VISHWATEJ REDDY	ECE	II
30	P VINEETH KUMAR	ECE	II
31	K KARTHIK	ECE	II
32	R SATYASRI RUPA	AERO	II
33	K RAHUL	AERO	II
34	P PRUTHVI SHANKAR	AERO	II
35	N DEEPAK	AERO	II
36	G MAMATHA	IT	II
37	M POOJA	IT	II
38	M MAMATHA	IT	II
39	VAISHALI CHAVAN	EEE	II
40	E NAVEEN	EEE	II
41	SADVIKA	CIVIL	II
42	P PREM SAI	CIVIL	II

K. Srinivas

Vysapuri, Bandlaguda Post:Keshavgirl,
Hyderabad-500 005, TELANGANA INDIA
Tel: 040-64596979,8978380692.
Fax: 040-24455003
E-mail: principal.mahaveer@gmail.com
Website: www.mist.ac.in,

MAHAVEER

Approved by AICTE, Affiliated to JNTUH Hyd

Dt:2-10-201

Event Name: Gandhi Jayanthi Attended in JNTUH

Students Participation List

S NO	NAME OF THE STUDENT	BRANCH	YEAR
1	PADMAVATHI PALIWAL	CSE	II
2	M VINAY	CSE	II
3	M AISHWARYA	CSE	II
4	N RENU SREE	CSE	II
5	K. RAMYA	CSE	II
6	R KALYAN SAI	CSE	II
7	G VISHWATEJ REDDY	ECE	II
8	P VINEETH KUMAR	ECE	II
9	K KARTHIK	ECE	II
10	R SATYASRI RUPA	AERO	II
11	K RAHUL	AERO	II
12	P PRUTHVI SHANKAR	AERO	II
13	N DEEPAK	AERO	II
14	G MAMATHA	IT	II
15	M POOJA	IT	II
16	M MAMATHA	IT	II
17	VAISHALI CHAVAN	EEE	II
18	E NAVEEN	EEE	II
19	SADVIKA	CIVIL	II
20	P PREM SAI	CIVIL	II

Khushi!

Vysapuri, Bandlaguda Post:Keshavgiri,
Hyderabad-500 005, TELANGANA INDIA
Tel: 040-64596979,8978380692
Fax: 040-24455003
E-mail: principal.mahaveer@gmail.com,
Website: www.mist.ac.in,

MAHAVEER

Approved by AICTE, Affiliated to JNTUH,Hyd.



Date: 01-10-2019

CIRCULAR

Sub: Batukamma Celebrations

All the faculty members and students are here by informed that "Batukamma Celebrations" will be organised by NSS unit of Mahaveer Institute Of Science and Technology is scheduled on 3RD OCTOBER 2019 between 9.30AM to 2.00PM at indira park Hyderabad. Students, teaching and non-teaching staff members are requested to participate this event.

Copy to:

All Hod's, Principal
polytechnic, Exam
Branch incharge,
Librarian

PRINCIPAL

PRINCIPAL
MAHAVEER
INSTITUTE OF SCIENCE & TECHNOLOGY
Bandlaguda, Hyd-500 005.

PRINCIPAL
MAHAVEER
INSTITUTE OF SCIENCE & TECHNOLOGY
Bandlaguda, Hyd-500 005.

Vysapuri, Bandlaguda Post:Keshavgiri,
Hyderabad-500 005, TELANGANA INDIA
Tel: 040-64596979,8978380692.
Fax: 040-24455003
E-mail: principal.mahaveer@gmail.com
Website: www.mist.ac.in.

MAHAVEER
INSTITUTE OF SCIENCE & TECHNOLOGY
Approved by AICTE, Affiliated to JNTUH,Hyd.



15	Activity	Batukamma Celebrations	3-10-2019
----	----------	------------------------	-----------

This programme was conducted at *INDIRA Park* Hyderabad by NSS Unit MIST on 3rd October 2019, The guest of this programme was *Sri Bandaru dathrathreya garu* governor of *himachal Pradesh*, the theme of this programme was to spread our traditional festivals to the youth, nearly 35 members of our college girl students were participated in this celebrations along with NSS programme officer *Dr.M Vasantha lakshmi garu*.



Kishu
PRINCIPAL
MAHAVEER

Vyasapur, Bandlaguda Post, Keshavnagar,
Hyderabad 500 006, TELANGANA INDIA
Tel: 040-64606070, 6970300002
Fax: 040-24460003
E-mail: principal.mahaveer@gmail.com
Website: www.mahaveer.ac.in

MAHAVEER

Approved by AICTE, Affiliated to JNTU(Hy)

DI:03-10-20

Event Name: Batukamma Celebrations

ORGANIZING COMMITTEE

S NO	NAME OF THE FACULTY	DESIGNATION	DEPT
1	Dr. M. Vasanthakumari	ASSOCIATE PROFESSOR	CIVIL

K. K. K.
PRINCIPAL
MAHAVEER
HYD

Vysapuri, Bandlaguda Post: Keshavgiri.
Hyderabad-500 005, TELANGANA INDIA
Tel: 040-64596979, 8978380692.
Fax: 040-24455003
E-mail: principal.mahaveer@gmail.com
Website: www.mist.ac.in,

MAHAVEER

Approved by AICTE. Affiliated to JNTUH, Hyd.



20	LOKA SAMHITHA	IT	III
21	MARAM AKSHITHA	IT	III
22	SAMA NAVYA	IT	III
23	G MAMATHA	IT	II
24	M POOJA	IT	II
25	M MAMATHA	IT	II
26	CHIDUMULA APARNA	EEE	III
27	GAJJALA SAI SREEYA	EEE	III
28	V SWATHI	EEE	III
29	VAISHALI CHAVAN	EEE	II
29	MATETI AAKANKSHA	EEE	II
30	SADVIKA	CIVIL	II
31	A SRILEKHA	CIVIL	II
32	ANNALDAS JANAKI	CIVIL	III
33	ESSAM KAVYA	CIVIL	III
34	TURUKA PAVANI	CIVIL	III
35	NADELLA JAHNAVI	CSE	III

PRINCIPAL
MAHAVEER
INSTITUTE OF SCIENCE & TECHNOLOGY

Vysapuri, Bandlaguda Post: Keshavgi,
Hyderabad-500 005, TELANGANA INDIA
Tel: 040-64596979, 8978380692
Fax: 040-24455003
E-mail: principal.mahaveer@gmail.com
Website: www.mist.ac.in

MAHAVEER



Approved by AICTE. Affiliated to JNTUH Hyd

Dt:3-10-2019

Event Name: Batukamma Celebrations

Students Participation List

S NO	NAME OF THE STUDENT	BRANCH	YEAR
1	PADMAVATHI PALIWAI	CSE	II
2	M AISHWARYA	CSE	II
3	N RENU SREE	CSE	II
4	K. RAMYA	CSE	II
5	GEETHIKA C	CSE	III
6	GANECHARY SHREYA	CSE	III
7	G.HARIKA	CSE	III
8	DANDA DEEKSHITHA	ECE	II
9	DIGUDUBAI MOUNIKA	ECE	II
10	KOTHA HARSHINI	ECE	II
11	AKULA RAMYA SREE	ECE	III
12	BONALA MANEESHA	ECE	III
13	CHERUKURI PAVITHRA	ECE	III
14	R SATYASRI RUPA	AERO	II
15	GOLKONDA RESHIKA RANI	AERO	II
16	SANGAM NAGALAXMI	AERO	II
17	TAPATTLA RADHIKA	AERO	II
18	ADIRE SPANDANA	AERO	III
19	GOLLA VAISHNAVI	AERO	III

Keshavgi

PRINCIPAL

Vysapuri, Bandlaguda Post:Keshavgiri,
Hyderabad-500 005, TELANGANA INDIA
Tel: 040-64596979,8978380692.
Fax: 040-24455003
E-mail: principal.mahaveer@gmail.com,
Website: www.mist.ac.in,

MAHAVEER

Approved by AICTE, Affiliated to JNTUH.Hyd.



Date 16-10-2019

CIRCULAR

Sub: A Seminar On Be Fit And Being Healthy

All the faculty members and students are here by informed that "A Seminar On Be Fit And Being Healthy" will be organised by NSS unit of Mahaveer Institute Of Science and Technology is scheduled on 18TH OCTOBER 2019 between 9.30AM to 2.00PM in our college campus. Students, teaching and non-teaching staff members are requested to participate this event.

Copy to:

All Hod's, Principal
polytechnic, Exam
Branch incharge,
Librarian

PRINCIPAL

PRINCIPAL
MAHAVEER
INSTITUTE OF SCIENCE & TECH
Bandlaguda, Hyd-500 005.

PRINCIPAL
MAHAVEER
INSTITUTE OF SCIENCE & TECHNOLOGY
Bandlaguda, Hyd-500 005.

Vysapuri, Bandlaguda Post:Keshavgiri,
Hyderabad-500 005, TELANGANA INDIA
Tel: 040-64596979,8978380692,
Fax: 040-24455003
E-mail: principal.mahaveer@gmail.com
Website: www.mist.ac.in.

MAHAVEER
INSTITUTE OF SCIENCE & TECHNOLOGY
Approved by AICTE, Affiliated to JNTUH,Hyd.



16	Activity	A Seminar On Be Fit And Being Healthy	18-10-2019
----	----------	---------------------------------------	------------

This programme was organized by NSS programme officer Dr.M vasantha lakshmi as a part of *FIT INDIA Programme* a call given by Honorable prime Minsiter *Sri narendra Modi Garu* on 18th October 2019 as a *BE Fit And Be Halthy* . The guest of this programme was *KIRAN DEMBLA* celebrity personal fitness Trainer, DJ, mountaineer, Nutritionist, six pack mother. For this programme *Sri S Vijayalakshmi garu* chairmen of Mahaveer institute of Science and Technology, and all lady faculty were participated. In this session all faculty members clarified their doubts regarding Diet, exercise, yoga and meditation.



Kishu
PRINCIPAL

Vysapuri, Bandlaguda Post:Keshavgiri,
Hyderabad-500 005, TELANGANA INDIA
Tel: 040-64596979,8978380692,
Fax: 040-24455003
E-mail: principal.mahaveer@gmail.com
Website: www.mist.ac.in,

MAHAVEER

Approved by AICTE, Affiliated to JNTUH,Hyd.



Dt:18-10-2019

Event Name:A Seminar On Be Fit And Being Healthy

ORGANIZING COMMITTEE

S NO	NAME OF THE FACULTY	DESIGNATION	DEPT
1	Dr M Vasanthaxmi	ASSOCIATE PROFESSOR	CIVIL

Keshavi
PRINCIPAL
MAHAVEER
INSTITUTE OF SCIENCE & TECHNOLOGY
Bandlaguda, Hyd-500 005.

Vysapuri, Bandlaguda Post:Keshavgi,
Hyderabad-500 005, TELANGANA INDIA
Tel: 040-64596979,8978380692,
Fax: 040-24455003
E-mail: principal.mahaveer@gmail.com
Website: www.mist.ac.in,

MAHAVEER

Approved by AICTE, Affiliated to JNTUH,Hyd



22.	KVBK NAGASREE	IT
23.	K SWATHI	IT
24.	D PRIYANKA	IT
25.	G BHAVANI	MECH
26.	K VARALKSHMI	CIVIL
27.	HEMALATHA	CIVIL
28.	RAMYA	CIVIL
29.	ANITHA	CIVIL
30.	JYOTHI	CIVIL
31.	DR. M VASANTHA LAKSHMI	CIVIL
32.	DR. R PARTHIBHA	H&S
33.	P RAGINI	H&S
34.	JAYA SREE	H&S
35.	K MADHAVI	H&S
36.	K S LATHA	H&S
37.	K DEEPTHI	H&S
38.	DR V VINEETHA	H&S
39.	V SWETHA	H&S
40.	J MEGHANA	H&S
41.	K S ARCHNA	MBA
42.	SANA SULTANA	MBA
43.	PRAMODA HOLISTER	MBA

Kishu
PRINCIPAL
MAHAVEER
INSTITUTE OF SCIENCE & TECHNOLOGY
HYDARABAD-500 005.

Vysapuri, Bandlaguda Post:Keshavgi,
Hyderabad-500 005, TELANGANA INDIA
Tel: 040-64596979,8978380692,
Fax: 040-24455003
E-mail: principal.mahaveer@gmail.com
Website: www.mist.ac.in,

MAHAVEER

Approved by AICTE, Affiliated to JNTUH,Hyd.

Dt:18-10-20

Event Name: A Seminar On Be Fit And Being Healthy

Faculty Participation List

S NO	NAME OF THE FACULTY	DEPT
1.	M SWAPNA	CSE
2.	M SRIVIDHYA	CSE
3.	G MANASA	CSE
4.	G SOWJANYA	CSE
5.	D SRILATHA	CSE
6.	K KAVYASREE	CSE
7.	P VIGNESHWARI	CSE
8.	J MADHAVI	CSE
9.	D SUNITHA	ECE
10.	R PRIYANKA	ECE
11.	K ARCHANA	ECE
12.	G SOWJANYA	ECE
13.	KIRPAULKOUR	ECE
14.	RUPA	ECE
15.	HIMAJA	ECE
16.	E SARASWATHI	EEE
17.	K DIVYA	EEE
18.	M JYOTHI	EEE
19.	R HIMABINDU	EEE
20.	ARSHYA	EEE
21.	BHARGHAVI	EEE

K. S. S.
PRINCIPAL

Vysapuri, Bandlaguda Post:Keshavgiri,
Hyderabad-500 005, TELANGANA INDIA
Tel: 040-64596979,8978380692
Fax: 040-24455003
E-mail: principal.mahaveer@gmail.com,
Website: www.mist.ac.in.

MAHAVEER



Approved by AICTE. Affiliated to JNTUH,Hyd.

Date: 25-10-19

CIRCULAR

Sub: Traditional day at MIST campus

All the faculty members and students are here by informed that "Traditional day at MIST campus" will be organised by NSS unit of Mahaveer Institute Of Science and Technology is scheduled on **26TH OCTOBER 2019** between 9.30AM to 2.00PM in our college campus. Students, teaching and non-teaching staff members are requested to participate this event.

Copy to:

All Hod's, Principal
polytechnic, Exam
Branch incharge,
Librarian

PRINCIPAL

PRINCIPAL
MAHAVEER
INSTITUTE OF SCIENCE & TECHNOLOGY
Bandlaguda, Hyd-500 005.

PRINCIPAL
MAHAVEER
INSTITUTE OF SCIENCE & TECHNOLOGY
Bandlaguda, Hyd-500 005.

Vysapuri, Bandlaguda Post:Keshavgi,
Hyderabad-500 005, TELANGANA INDIA
Tel: 040-64596979,8978380692,
Fax: 040-24455003
E-mail: principal.mahaveer@gmail.com
Website: www.mist.ac.in.

MAHAVEER
INSTITUTE OF SCIENCE & TECHNOLOGY
Approved by AICTE, Affiliated to JNTUH,Hyd.



17	Activity	Traditional day at MIST campus	26-10-19
----	----------	--------------------------------	----------

This programme was organized at Mahaveer Institute of Science and Technology, the guest of this programme were *Sri Dr.K.S.S.S.N Reddy garu principal of MIST, Sri S.Surendar Reddy garu secretary of MIST, Sri S.Dhanunjay Reddy garu Joint Secretary* to expnad our tradition to the young generations. All the teaching, non teaching and all the students of Our college were participated and different events were organized especially students were represented our *29 states of tradional costumes of India, tradional dances*, songs, skids, *tradional food stall, bathukamma, Kolatam*, programmes were conducted on that day before that day some events were conducted to the students like Rangoli, mehendhi, Miss Mahaveer, MR Mahaveer etc, at the end of the day all teaching, non teaching faculty and studentes were entertained a lot and the prizes were distributed to the students who won the prizes on the compietions.

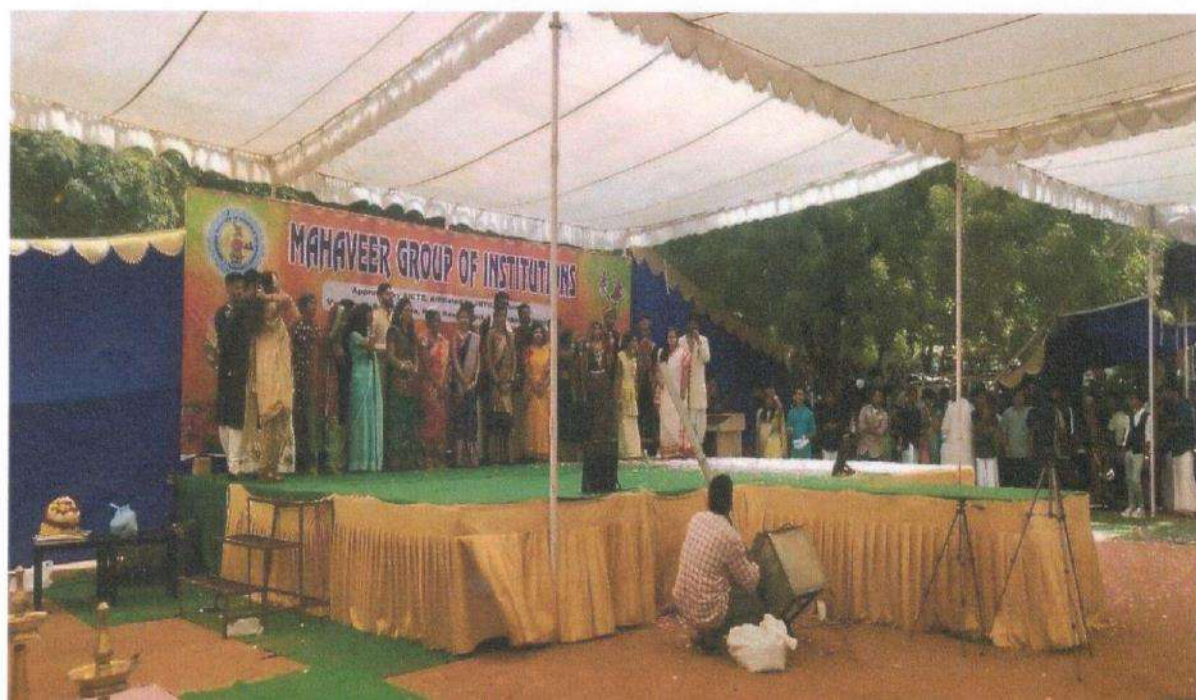

Vyasapuri, Bandlaguda Post:Keshavagiri,
Hyderabad-500 005, TELANGANA INDIA
Tel: 040-64596979,8978380692,
Fax: 040-24455003
E-mail: principal.mahaveer@gmail.com
Website: www.mist.ac.in.

MAHAVEER
INSTITUTE OF SCIENCE & TECHNOLOGY
Approved by AICTE, Affiliated to JNTUH,Hyd.



Keshav

Vysapuri, Bandlaguda Post:Keshavgi,
Hyderabad-500 005, TELANGANA INDIA
Tel: 040-64596979,8978380692,
Fax: 040-24455003
E-mail: principal.mahaveer@gmail.com
Website: www.mist.ac.in,

MAHAVEER

Approved by AICTE. Affiliated to JNTUH.Hyd.



Dt: 26-10-2019

Event Name: Traditional Day Celebrations At Mist Campus

Organizing Committe

S NO	NAME OF THE FACULTY	DESIGNATION	DEPT
1	Dr M Vasanthaxmi	ASSOCIATE PROFERSOR	CIVIL

Kanthy
PRINCIPAL
MAHAVEER
INSTITUTE OF SCIENCE & TECHNOLOGY
Bandlaguda, Hyd-500 005.

Vysapuri, Bandlaguda Post:Keshavgiri,
Hyderabad-500 005, TELANGANA INDIA
Tel: 040-64596979,8978380692,
Fax: 040-24455003
E-mail: principal.mahaveer@gmail.com
Website: www.mist.ac.in,

MAHAVEER

Approved by AICTE. Affiliated to JNTUH,Hyd



S NO	STUDENT NAME	BRANCH	YEAR
20	GEETHIKA C	CSE	III
21	GANECHARY SHREYA	CSE	III
22	BAIMUTHAKA TRIVENI	CSE	III
23	BORRA SOMESHWAR REDDY	IT	III
24	KARANKOT KEERTHI	IT	III

K. Srinivas
PRINCIPAL
MAHAVEER
INSTITUTE OF SCIENCE AND TECHNOLOGY
Bandlaguda,Hyd-500 005.

Vysapuri, Bandlaguda Post Keshavgiri,
Hyderabad-500 005, TELANGANA INDIA
Tel: 040-64596979,8978380692
Fax: 040-24455003
E-mail: principal.mahaveer@gmail.com
Website: www.mist.ac.in,

MAHAVEER

Approved by AICTE. Affiliated to JNTUH.Hyd



Dt:26-10-2019

Event Name: Traditional Day Celebrations At Mist Campus

STUDENT ORGANIZING COMMITTEE

S NO	STUDENT NAME	BRANCH	YEAR
1	DADIGE SANTHOSH KUMAR	ECE	IV
2	BIJJALA SHRAVANI	ECE	IV
3	CHALLA VARUN REDDY	ECE	IV
4	JADAV SATHISH	EEE	IV
5	RAJARAPU VIJAY	EEE	IV
6	BADAM ABILASH	CSE	IV
7	MARIKANTI HARIKA REDDY	CSE	IV
8	PAPINENI MANOJ KUMAR	CSE	IV
9	J NIKITHA	CSE	IV
10	GADDAM SAI TEJA REDDY	CSE	IV
11	JAKKULA VAMSHI	IT	IV
12	ADURLA PAVAN	IT	IV
13	AKULA PRANATHI	IT	IV
14	YASA ABHINAYA	IT	IV
15	GAJELLI VAMSHI KRISHNA	MECH	IV
16	LUNAVATH GANESH	MECH	IV
17	N SRIKANTH REDDY	MECH	IV
18	KOTHALAPURAM ANUSHA	MECH	IV
19	GURRAM MANI RUPAK	CSE	III

K. S. S.

Vysapuri, Bandlaguda Post:Keshavgiri,
Hyderabad-500 005, TELANGANA INDIA
Tel: 040-64596979,8978380692,
Fax: 040-24455003
E-mail: principal.mahaveer@gmail.com,
Website: www.mist.ac.in,

MAHAVEER

Approved by AICTE, Affiliated to JNTUH,Hyd.



Date: 30-10-2019

CIRCULAR

Sub: Unity Day At MIST Campus

All the faculty members and students are here by informed that "Unity Day At MIST Campus" will be organised by NSS unit of Mahaveer Institute Of Science and Technology is scheduled on 31ST OCTOBER 2019 between 9.30AM to 2.00PM in our college campus. Students, teaching and non-teaching staff members are requested to participate this event.

Copy to:

All Hod's, Principal
polytechnic, Exam
Branch incharge,
Librarian

PRINCIPAL

PRINCIPAL
MAHAVEER
INSTITUTE OF SCIENCE & TECHNOLOGY
Bandlaguda, Hyd-500 005.

PRINCIPAL
MAHAVEER
INSTITUTE OF SCIENCE & TECHNOLOGY
Bandlaguda, Hyd-500 005.

Vysapuri, Bandlaguda Post:Keshavagiri,
Hyderabad-500 005, TELANGANA INDIA
Tel: 040-64596979,8978380692,
Fax: 040-24455003
E-mail: principal.mahaveer@gmail.com
Website: www.mist.ac.in.

MAHAVEER
INSTITUTE OF SCIENCE & TECHNOLOGY
Approved by AICTE, Affiliated to JNTUH,Hyd.



18	Activity	Unity Day At MIST Campus	31-10-2019
----	----------	--------------------------	------------

According to the instructions given by UGC regarding *Celebrations Of Birth Anniversary Of Sardar Vallabhbhai Patel* on 31st October 2019 *Rashtriya Ekta Diwas as a National UNITY* Day was organized by NSS Cell MIST at Mahaveer Institute Of Science And Technology. In this programme the students of Mahaveer college were participated and they celebrated Sardar Vallabhbhai patel jayathi and they gave some slogans on Unity.

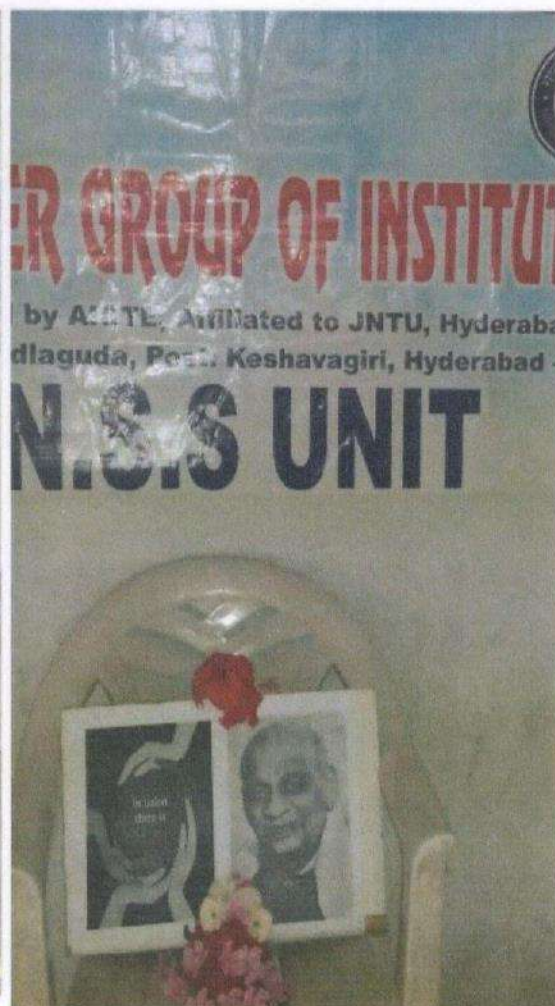

Vysapuri, Bandlaguda Post:Keshavgiri,
Hyderabad-500 005, TELANGANA INDIA
Tel: 040-64596979,8978380692,
Fax: 040-24455003
E-mail: principal.mahaveer@gmail.com
Website: www.mist.ac.in.

MAHAVEER
INSTITUTE OF SCIENCE & TECHNOLOGY
Approved by AICTE, Affiliated to JNTUH,Hyd.

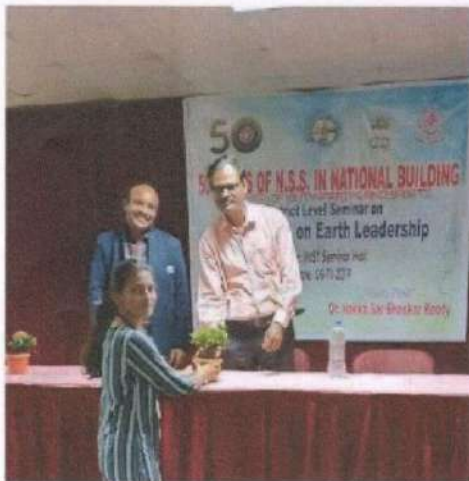

50 YEARS OF N.S.S. IN NATIONAL BUILDING
National Level Seminar on
Geo-Spirit in Earth Leadership
Dr. Anand Kumar Reddy

పర్యావృత్తి కాపాడాలి
మాతృక భూమిని పరిరక్షించాలి
మాతృక భూమిని పరిరక్షించాలి
మాతృక భూమిని పరిరక్షించాలి

పర్యావృత్తి కాపాడాలి
మాతృక భూమిని పరిరక్షించాలి
మాతృక భూమిని పరిరక్షించాలి
మాతృక భూమిని పరిరక్షించాలి

Principal
PRINCIPAL
MAHAVEER
INSTITUTE OF SCIENCE & TECHNOLOGY

Vysapuri, Bandlaguda Post Keshavgirl,
Hyderabad-500 005, TELANGANA INDIA
Tel: 040-64596979,8978380692,
Fax: 040-24455003
E-mail: principal.mahaveer@gmail.com
Website: www.mist.ac.in,

MAHAVEER

Approved by AICTE, Affiliated to JNTUH,Hyd



Dt:8-11-2019

Event Name: GEO-SPIRIT For Earth Leadership District Level Programme

Students Organizing Committee

S NO	NAME OF THE STUDENT	BRANCH	YEAR
1.	DEVARAM AAKASH REDDY	ECE	IV
2.	G HARISH	ECE	IV
3.	BIJJALA SHRAVANI	ECE	IV
4.	SOM APARNA	ECE	IV
5.	MADASU AISHWARYA	ECE	IV
6.	ANDE NAVEEN KUMAR	IT	IV
7.	AKULA PRANATHI	IT	IV
8.	GUDAPATI VEENA	EEE	IV
9.	RENDLA RANJITH	EEE	IV
10.	RIKKA VANDANA	CSE	IV
11.	J NIKITHA	CSE	IV
12.	JAKKULA VAMSHI	CSE	IV

Dt:8-11-2019

ORGANIZING COMMITTEE

S NO	NAME OF THE FACULTY	DESIGNATION	DEPT
1	Dr M Vasanthaxmi	ASSOCIATE PROFERSOR	CIVIL

K. S. S.

PRINCIPAL

MAHAVEER

Vysapuri, Bandlaguda Post:Keshavgirl,
Hyderabad-500 005, TELANGANA INDIA
Tel: 040-64596979,8978380692,
Fax: 040-24455003
E-mail: principal.mahaveer@gmail.com
Website: www.mist.ac.in.

MAHAVEER

Approved by AICTE. Affiliated to JNTUH,Hyd.



19	Activity	GEO-SPIRIT For Earth Leadership District Level Programme	8-11-2019
----	----------	--	-----------

This is a one day district level seminar with the theme *GEO-SPIRIT For Earth Leadership* organized by NSS MIST with the help of NSS cell JNTUH at Mahaveer Institute of Science and Technology on 8th November 2019 as part of *50 years of NSS in National building*, the guest of this programme were *Dr. G. Narsimha garu* NSS coordinator JNTUH, *Dr N.Saibhaskar Reddy garu National Expert At International Centre For Environmental Management*, *Dr.K.S.S.S.N Reddy garu* Principal of our college Approximately 300 members were participated including students and faculty members, after completion of this programme participants educated about state and national level NSS programmes and encourage the participants to give the low cost efficient solution to the social problems.

K.S.S.S.N Reddy

PRINCIPAL
MAHAVEER
INSTITUTE OF SCIENCE & TECHNOLOGY

Vysapuri, Bandlaguda Post:Keshavgiri,
Hyderabad-500 005, TELANGANA INDIA
Tel: 040-64596979,8978380692,
Fax: 040-24455003
E-mail: principal.mahaveer@gmail.com,
Website: www.mist.ac.in,

MAHAVEER

INSTITUTE OF SCIENCE & TECHNOLOGY
Approved by AICTE, Affiliated to JNTUH,Hyd.



Date: 6-11-2019

CIRCULAR

Sub: GEO-SPIRIT For Earth Leadership District Level Programme

All the faculty members and students are here by informed that "GEO-SPIRIT For Earth Leadership District Level Programme" will be organised by NSS unit of Mahaveer Institute Of Science and Technology is scheduled on 8TH NOVEMBER 2019 between 9.30AM to 2.00PM in our college campus. Students, teaching and non-teaching staff members are requested to participate this event.

Copy to:

All Hod's, Principal
polytechnic, Exam
Branch incharge,
Librarian

PRINCIPAL

PRINCIPAL
MAHAVEER
INSTITUTE OF SCIENCE & TECHNOLOGY
Bandlaguda, Hyd-500 005.

PRINCIPAL
MAHAVEER
INSTITUTE OF SCIENCE & TECHNOLOGY
Bandlaguda, Hyd-500 005.

Vysapuri, Bandlaguda Post:Keshavgiri,
Hyderabad-500 005, TELANGANA INDIA
Tel: 040-64596979,8978380692,
Fax: 040-24455003
E-mail: principal.mahaveer@gmail.com
Website: www.mist.ac.in,

MAHAVEER

Approved by AICTE. Affiliated to JNTUH.Hyd



Dt:31-10-2019

Event Name: Unity Day At MIST Campus

Students Organizing Committee

S NO	NAME OF THE STUDENT	BRANCH	YEAR
1.	PADMAVATHI PALIWAL	CSE	II
2.	M VINAY	CSE	II
3.	K. RAMYA	CSE	II
4.	R KALYAN SAI	CSE	II
5.	G VISHWATEJ REDDY	ECE	II
6.	P VINEETH KUMAR	ECE	II
7.	K KARTHIK	ECE	II
8.	R SATYASRI RUPA	AERO	II
9.	K RAHUL	AERO	II
10.	P PRUTHVI SHANKAR	AERO	II
11.	N DEEPAK	AERO	II
12.	G MAMATHA	IT	II
13.	M POOJA	IT	II
14.	M MAMATHA	IT	II
15.	VAISHALI CHAVAN	EEE	II
16.	E NAVEEN	EEE	II
17.	SADVIKA	CIVIL	II
18.	P PREM SAI	CIVIL	II
19.	J NIKITHA	CSE	IV
20.	JAKKULA VAMSHI	CSE	IV

Vysapuri, Bandlaguda Post: Keshavgi,
Hyderabad-500 005, TELANGANA INDIA
Tel: 040-64596979,8978380692.
Fax: 040-24455003
E-mail: principal.mahaveer@gmail.com
Website: www.mist.ac.in.

MAHAVEER

Approved by AICTE. Affiliated to JNTUH,Hyd



Dt:31-10-2019

Event Name: Unity Day At MIST Campus

Organizing Committee

S NO	NAME OF THE FACULTY	DESIGNATION	DEPT
1	Dr M Vasanthaxmi	ASSOCIATE PROFERSOR	CIVIL

K. Srinivas

PRINCIPAL

MAHAVEER

INSTITUTE OF SCIENCE & TECHNOLOGY
Bandlaguda, Hyd-500 005.

Vysapuri, Bandlaguda Post, Keshavgi,
Hyderabad-500 005, TELANGANA INDIA
Tel: 040-64596979, 8978380692
Fax: 040-24455003
E-mail: principal.mahaveer@gmail.com,
Website: www.mist.ac.in,

MAHAVEER



Approved by AICTE, Affiliated to JNTUH, Hyd.

Date: 20-11-2019

CIRCULAR

Sub: Attended WASH Programme In JNTUH

All the faculty members and students are here by informed that "Attended WASH Programme In JNTUH" will be organised by NSS unit of Mahaveer Institute Of Science and Technology is scheduled on 21ST NOVEMBER 2019 between 9.30AM to 2.00PM in JNTUH Kukatpally . Students, teaching and non-teaching staff members are requested to participate this event.

Copy to:

All Hod's, Principal
polytechnic, Exam
Branch incharge,
Librarian

PRINCIPAL

PRINCIPAL
MAHAVEER
INSTITUTE OF SCIENCE & TECHNOLOGY
Bandlaguda, Hyd-500 005.

PRINCIPAL
MAHAVEER
INSTITUTE OF SCIENCE & TECHNOLOGY
Bandlaguda, Hyd-500 005.

Vysapuri, Bandlaguda Post:Keshavgiri,
Hyderabad-500 005, TELANGANA INDIA
Tel: 040-64596979,8978380692,
Fax: 040-24455003
E-mail: principal.mahaveer@gmail.com
Website: www.mist.ac.in.

MAHAVEER
INSTITUTE OF SCIENCE & TECHNOLOGY
Approved by AICTE, Affiliated to JNTUH,Hyd.



20	Activity	Attended WASH Programme In JNTUH	29-11-2019
----	----------	----------------------------------	------------

This programme was organized by *UNICEF, MGNCRE* and *NSS unit cell at JNTUH*, in this programme all the NSS programme officers under JNTUH were participated, from our college *DR.M Vasantha lakshmi* was participated, the main theme of this programme was to aware all the programme coordinators about *Environmental protection, the cleanliness of the surroundings, conservation of water resources and pollution prevention by Sri Shiva Kumar consultant of UNICEF WASH(Water Sanitation and Hygiene)*, after this awareness programme Sri Dr.Narasimha also give some valuable suggestions to programme coordinators to how to aware the students and responsibilities of the students regarding NSS activities. Nearly 60 members of programme coordinators of JNTUH affiliated colleges were participated.

పర్యావరణ పరిరక్షణపై దృష్టి సారించాలి



అవగాహనలో పాల్గొన్న అతిథులు, ప్రోగ్రాం లభిస్తున్న

కేవల పరిసరాల పరిశుభ్రత, పర్యావరణ పరిరక్షణ, జల వనరుల సంరక్షణ, కాలుష్య నివారణ వంటి అంశాలపై అవగాహన కల్పించాల్సిన అవసరం ఉందని యూనిసెఫ్ వాచ్(వాటర్, శానిటేషన్ అండ్ హైజిన్) కన్సల్టెంట్ శివకుమార్ తెలిపారు. కేవల యూనిసెఫ్ లో ఎస్ ఎస్ఎస్ సెల్, యూనిసెఫ్, ఎంజీఎస్ఎల్ఈ సంయుక్త ఆధ్వర్యంలో గురువారం అవగాహన కార్యక్రమాన్ని నిర్వహించారు. కేవల యూనిసెఫ్ పరిధిలోని అనుబంధ కళాశాలల అధ్యాపకులు, ప్రోగ్రాం ఆఫీసర్లు పాల్గొన్న ఈ కార్యక్రమంలో యూనిసెఫ్ ఆధ్వర్యంలో చేపట్టిన వాచ్ పల్ల ప్రతిబద్ధిలో అవగాహనను పెంపొందించి పర్యావరణాన్ని పరిరక్షించేందుకు పర్యటన తీసుకోవాలని సూచించారు. ఇప్పటికే ఎస్ఎస్ఎస్ ఆధ్వర్యంలో చేపట్టిన పలు సేవా కార్యక్రమాలు, అవగాహన కార్యక్రమాలను ఎస్ఎస్ఎస్ ఎస్ ప్రోగ్రాం కో-ఆర్డినేటర్ ప్రొఫెసర్ వరనియా సమావేశంలో తెలియజేశారు. రాజ్ లోలో చేపట్టనున్న కార్యక్రమాలను వివరించారు. నీళ్లు, పరిసరాల పరిశుభ్రత, స్టైటిటీ జిన్నర్, హైజిన్, గాలి కాలుష్యం వంటి విషయాలపై విద్యార్థులకు అవగాహన కల్పించడం బాధ్యతగా తీసుకోవాలని అధ్యాపకులకు సూచించారు. కార్యక్రమంలో ఎస్ఎస్ఎస్ ప్రోగ్రాం ఆఫీసర్లతో పాటు సుమారు 80 మంది ప్రతినిధులు పాల్గొన్నారు.

Kshy
PRINCIPAL
MAHAVEER

Vysapuri, Bandlaguda Post:Keshavgiri,
Hyderabad-500 005, TELANGANA INDIA
Tel: 040-64596979,8978380692.
Fax: 040-24455003
E-mail: principal.mahaveer@gmail.com
Website: www.mist.ac.in,

MAHAVEER

Approved by AICTE, Affiliated to JNTUH,Hyd.



Dt:18-12-2019

Event Name: Kill Cancer Programme Organized At JNTUH With ISCON

ORGANIZING COMMITTEE

S NO	NAME OF THE FACULTY	DESIGNATION	DEPT
1	Dr M Vasanthaxmi	ASSOCIATE PROFERSOR	CIVIL

K. Subhag

PRINCIPAL
MAHAVEER
INSTITUTE OF SCIENCE & TECHNOLOGY

Vysapuri, Bandlaguda Post:Keshavgi,
Hyderabad-500 005, TELANGANA INDIA
Tel: 040-64596979,8978380692.
Fax: 040-24455003
E-mail: principal.mahaveer@gmail.com
Website: www.mist.ac.in,

MAHAVEER

Approved by AICTE. Affiliated to JNTUH,Hyd



Dt:18-12-2019

Event Name: Kill Cancer Programme Organized At JNTUH With ISCON

STUDENTS ORGANIZING COMMITTEE

S NO	STUDENT NAME	BRANCH	YEAR
1	DADIGE SANTHOSH KUMAR	ECE	IV
2	BIJALA SHRAVANI	ECE	IV
3	CHALLA VARUN REDDY	ECE	IV
4	JADAV SATHISH	EEE	IV
5	RAJARAPU VIJAY	EEE	IV
6	BADAM ABILASH	CSE	IV
7	MARIKANTI HARIKA REDDY	CSE	IV
8	PAPINENI MANOJ KUMAR	CSE	IV
9	J NIKITHA	CSE	IV
10	GADDAM SAI TEJA REDDY	CSE	IV
11	JAKKULA VAMSHI	IT	IV
12	ADURLA PAVAN	IT	IV
13	AKULA PRANATHI	IT	IV
14	YASA ABHINAYA	IT	IV
15	GAJJELLI VAMSHI KRISHNA	MECH	IV
16	LUNAVATH GANESH	MECH	IV
17	N SRIKANTH REDDY	MECH	IV
18	KOTHALAPURAM ANUSHA	MECH	IV
19	GURRAM MANI RUPAK	CSE	III

K. Subh

Vysapuri, Bandlaguda Post:Keshavgi,
Hyderabad-500 005, TELANGANA INDIA
Tel: 040-64596979,8978380692,
Fax: 040-24455003
E-mail: principal.mahaveer@gmail.com
Website: www.mist.ac.in.

MAHAVEER

Approved by AICTE. Affiliated to JNTUH,Hyd.



21	Activity	Kill Cancer Programme Organized At JNTUH With ISCON	18-12-2019
----	----------	---	------------

This programme was organized by *NSS cell JNTUH with ISKCON*, conducted at **JNTUH** on 18th december 2019, for this 200 members were participated from Mahaveer Institute Of Science And Technology along with NSS programme Officer Dr.M Vasantha lakshmi, the guest of this programme was *Dr. Tamilisai Soundara Rajan Garu Governer Of Telangana, Sri Jayesh Ranjan, IAS I/c Vice-Chancellor* and *Dr.Narsimha NSS programme coordinator JNTUH* , Nearly 50 college students were participated in this programme.

K. Sankar
PRINCIPAL
MAHAVEER
INSTITUTE OF SCIENCE & TECHNOLOGY
Bandlaguda, Hyd-500 005.

Vysapuri, Bandlaguda Post: Keshavgiri,
Hyderabad-500 005, TELANGANA INDIA
Tel: 040-64596979, 8978380692,
Fax: 040-24455003
E-mail: principal.mahaveer@gmail.com,
Website: www.mist.ac.in,

MAHAVEER



Approved by AICTE, Affiliated to JNTUH, Hyd.

Date: 16-12-2019

CIRCULAR

Sub: Kill Cancer Programme Organized At JNTUH With ISCON

All the faculty members and students are here by informed that "Kill Cancer Programme Organized At JNTUH With ISCON" programme will be organised by NSS unit of Mahaveer Institute Of Science and Technology in Association with jntuh is scheduled on 18TH DECEMBER 2019 between 10.0AM to 2.00PM in JNTUH. Students, teaching and non-teaching staff members are requested to participate this event.

Copy to:

All Hod's, Principal
polytechnic, Exam
Branch incharge,
Librarian

PRINCIPAL

PRINCIPAL
MAHAVEER
INSTITUTE OF SCIENCE & TECHNOLOGY
Bandlaguda, Hyd-500 005.

PRINCIPAL
MAHAVEER
INSTITUTE OF SCIENCE & TECHNOLOGY
Bandlaguda, Hyd-500 005.

Vysapuri, Bandlaguda Post: Keshavgiri,
Hyderabad-500 005, TELANGANA INDIA
Tel: 040-64596979, 8978380692
Fax: 040-24455003
E-mail: principal.mahaveer@gmail.com,
Website: www.mist.ac.in.

MAHAVEER



Approved by AICTE. Affiliated to JNTUH, Hyd.

Date: 16-12-2019

CIRCULAR

Sub: Participated In Megha Blood Donation Camp

All the faculty members and students are here by informed that "Participated In Megha Blood Donation Camp" will be organised by NSS unit of Mahaveer Institute Of Science and Technology in Association with JNTUH is scheduled on **18TH DECEMBER 2019** between 9.30AM to 2.00PM conducted at JNTUH KUKATPALLY. Students, teaching and non-teaching staff members are requested to participate this event.

Copy to:

All Hod's, Principal
polytechnic. Exam
Branch incharge,
Librarian

PRINCIPAL
MAHAVEER
INSTITUTE OF SCIENCE & TECHNOLOGY
Bandlaguda, Hyd-500 005.

PRINCIPAL

PRINCIPAL
MAHAVEER
INSTITUTE OF SCIENCE & TECHNOLOGY
Bandlaguda, Hyd-500 005.

Vysapuri, Bandlaguda Post:Keshavgiri,
Hyderabad-500 005, TELANGANA INDIA
Tel: 040-64596979,8978380692,
Fax: 040-24455003
E-mail: principal.mahaveer@gmail.com
Website: www.mist.ac.in.

MAHAVEER
INSTITUTE OF SCIENCE & TECHNOLOGY
Approved by AICTE, Affiliated to JNTUH,Hyd.



22	Activity	Participated In Megha Blood Donation Camp	18-12-2019
----	----------	---	------------

This programme was organized by *NSS cell JNTUH with ISKCON*, conducted at **JNTUH** on 18th december 2019, for this 200 members were participated from Mahaveer Institute Of Science And Technology along with NSS programme Officer Dr.M Vasantha lakshmi, the guest of this programme was *Dr. Tamilisai Soundara Rajan Garu Governor Of Telangana, Sri Jayesh Ranjan, IAS I/c Vice-Chancellor* and *Dr.Narsinha NSS programme coordinator JNTUH*, Nearly 100 college students were participated in this programme. In this programme 20 members of MIST students were donated BLOOD.



Ravi
PRINCIPAL
MAHAVEER

Vysapuri, Bandlaguda Post: Keshavgiri,
Hyderabad-500 005, TELANGANA INDIA
Tel: 040-64596979, 8978380692
Fax: 040-24455003
E-mail: principal.mahaveer@gmail.com,
Website: www.mist.ac.in,

MAHAVEER

Approved by AICTE. Affiliated to JNTUH, Hyd.



Date: 17-01-2020

CIRCULAR

Sub: Vivekananda Pushpanjali Programme

All the faculty members and students are here by informed that "Vivekananda Pushpanjali Programme" will be organised by NSS unit of Mahaveer Institute Of Science and Technology is scheduled on 18TH JANUARY 2019 between 9.30AM to 2.00PM in our college campus. Students, teaching and non-teaching staff members are requested to participate this event.

Copy to:

All Hod's, Principal
polytechnic, Exam
Branch incharge,
Librarian

PRINCIPAL

PRINCIPAL
MAHAVEER
INSTITUTE OF SCIENCE & TECHNOLOGY
Bandlaguda, Hyd-500 005.

PRINCIPAL
MAHAVEER
INSTITUTE OF SCIENCE & TECHNOLOGY
Bandlaguda, Hyd-500 005.

Vysapuri, Bandlaguda Post:Keshavgiri,
Hyderabad-500 005, TELANGANA INDIA
Tel: 040-64596979,8978380692,
Fax: 040-24455003
E-mail: principal.mahaveer@gmail.com
Website: www.mist.ac.in,

MAHAVEER

Approved by AICTE. Affiliated to JNTUH.Hyd.



Dt:18-12-2019

Event Name: Participated In Megha Blood Donation Camp

Organizing Committee

S NO	NAME OF THE FACULTY	DESIGNATION	DEPT
1	Dr M Vasanthaxmi	ASSOCIATE PROFERSOR	CIVIL

Keshavgiri

PRINCIPAL
MAHAVEER
INSTITUTE OF SCIENCE & TECHNOLOGY
Bandlaguda, Hyd-500 005.

Vysapuri, Bandlaguda Post: Keshavgiri,
Hyderabad-500 005, TELANGANA INDIA
Tel: 040-64596979, 8978380692.
Fax: 040-24455003
E-mail: principal.mahaveer@gmail.com
Website: www.mist.ac.in,

MAHAVEER

Approved by AICTE. Affiliated to JNTUH, Hyd



Dt:18-12-2019

Event Name: Participated In Megha Blood Donation Camp

Students Participating Committee

S NO	STUDENT NAME	BRANCH	YEAR
1.	CHALLA VARUN REDDY	ECE	IV
2.	JADAV SATHISH	EEE	IV
3.	RAJARAPU VIJAY	EEE	IV
4.	BADAM ABILASH	CSE	IV
5.	PAPINENI MANOJ KUMAR	CSE	IV
6.	J NIKITHA	CSE	IV
7.	GADDAM SAI TEJA REDDY	CSE	IV
8.	JAKKULA VAMSHI	IT	IV
9.	ADURLA PAVAN	IT	IV
10.	GAJELLI VAMSHI KRISHNA	MECH	IV
11.	LUNAVATH GANESH	MECH	IV
12.	GURRAM MANI RUPAK	CSE	III
13.	BORRA SOMESHWAR REDDY	IT	III
14.	M VINAY	CSE	II
15.	G VISHWATEJ REDDY	ECE	II
16.	R SATYASRI RUPA	AERO	II
17.	P PRUTHVI SHANKAR	AERO	II
18.	E NAVEEN	EEE	II
19.	K KARTHEEK	CIVIL	II

K. Srinivas
PRINCIPAL
MAHAVEER
INSTITUTE OF SCIENCE & TECHNOLOGY
Bandlaguda

Vysapuri, Bandlaguda Post:Keshavgiri,
Hyderabad-500 005, TELANGANA INDIA
Tel: 040-64596979,8978380692.
Fax: 040-24455003
E-mail: principal.mahaveer@gmail.com
Website: www.mist.ac.in.

MAHAVEER

Approved by AICTE, Affiliated to JNTUH,Hyd.



23	Activity	Vivekananda Pushpanjali Programme	18-01-2020
----	----------	-----------------------------------	------------

This programme was organized by NSS Unit cell MIST at MIST campus main seminar hall on the occasion of Swami viveka nanda jayanthi on 18th january 2020 , the guest of this programme were Rakha Sudhakar journalist Sakshi TV, Sri S.surendar Reddy secretary, Sri S.Dhanjay Reddy garu joint secretary, Dr.H.S.N Murthy grau academic director and Dr.K.S.S.S.N Reddy garu Principal and all the students and faculty members were participated in this programme.

K.S.S.S.N
PRINCIPAL
MAHAVEER
INSTITUTE OF SCIENCE & TECHNOLOGY
Bandlaguda, Hyd-500 005.

Vysapuri, Bandlaguda Post: Keshavgiri,
Hyderabad-500 005, TELANGANA INDIA
Tel: 040-64596979,8978380692.
Fax: 040-24455003
E-mail: principal.mahaveer@gmail.com
Website: www.mist.ac.in.

MAHAVEER

Approved by AICTE. Affiliated to JNTUH,Hyd



Kishu
PRINCIPAL
MAHAVEER
INSTITUTE OF SCIENCE & TECHNOLOGY
Bandlaguda, Hyd-500 005.

Vysapuri, Bandlaguda Post:Keshavgiri,
Hyderabad-500 005, TELANGANA INDIA
Tel: 040-64596979,8978380692,
Fax: 040-24455003
E-mail: principal.mahaveer@gmail.com
Website: www.mist.ac.in.

MAHAVEER

Approved by AICTE, Affiliated to JNTUH,Hyd



ఈనాడు
epaper eenadu.net

కళాశాల సెక్రటరీని అభినందించిన గవర్నర్



గవర్నర్ సుంచి జ్ఞాపికను అందుకుంటున్న సురేందర్ రెడ్డి

కాటేదాన్, న్యూస్ టుడే: నేతాజీ సుబాష్ చంద్రబోస్ జయంతిని పురస్కరించుకుని రాజేంద్రనగర్ మైలార్ దేవు పల్లి డివిజన్ పల్లెచెరువు మహావీర్ కళాశాల సెక్రటరీ సురేందర్ రెడ్డిని రాష్ట్ర గవర్నర్ సౌందరరాజన్ అభినందించారు. నగరంలోని ట్యాంక్ బండ్ లో ఉన్న రామకృష్ణమఠంలో గురువారం జరిగిన ఈ కార్యక్రమంలో ఆయనకు ఆయన్ను ప్రశంసించారు. ఈనెల 12న వివేకానంద జయంతి సుంచి నేతాజీ జయంతి వరకు వివిధ సామాజిక సేవా కార్యక్రమాలు చేపట్టినందున ప్రశంసాపత్రంతో పాటు జ్ఞాపికను బహుకరించారు.

Date : 24/01/2020 EditionName : TELANGANA(HYDERABAD)
PageNo : Page 06

Kshalya
PRINCIPAL
MAHAVEER

Vysapuri, Bandlaguda Post:Keshavgiri,
Hyderabad-500 005, TELANGANA INDIA
Tel: 040-64596979,8978380692.
Fax: 040-24455003
E-mail: principal.mahaveer@gmail.com,
Website: www.mist.ac.in,

MAHAVEER

Approved by AICTE, Affiliated to JNTUH,Hyd.



Date: 21-01-2019

CIRCULAR

Sub: Be good do good –Ramakrishna math

All the faculty members and students are here by informed that “Be good do good –Ramakrishna math” will be organised by NSS unit of Mahaveer Institute Of Science and Technology in Association with samskruthi foundation is scheduled on 23RD JANUARY 2019 between 9.30AM to 2.00PM at Ramakrishna math . Students, teaching and non-teaching staff members are requested to participate this event.

Copy to:

All Hod's, Principal
polytechnic, Exam
Branch incharge,
Librarian

PRINCIPAL

PRINCIPAL
MAHAVEER
INSTITUTE OF SCIENCE & TECHNOLOGY
Bandlaguda, Hyd-500 005.

PRINCIPAL
MAHAVEER
INSTITUTE OF SCIENCE & TECHNOLOGY
Bandlaguda, Hyd-500 005.

Vysapuri, Bandlaguda Post:Keshavgiri,
Hyderabad-500 005, TELANGANA INDIA
Tel: 040-64596979,8978380692,
Fax: 040-24455003
E-mail: principal.mahaveer@gmail.com
Website: www.mist.ac.in,

MAHAVEER

Approved by AICTE. Affiliated to JNTUH,Hyd



Dt:18-01-2020

Event Name: Vivekananda Pushpanjali Programme

ORGANIZING COMMITTEE

S NO	NAME OF THE FACULTY	DESIGNATION	DEPT
1	Dr M Vasanthaxmi	ASSOCIATE PROFESSOR	CIVIL

K. Srinivas
PRINCIPAL
MAHAVEER
INSTITUTE OF TECHNOLOGY
& MANAGEMENT
BANDLAGUDA POST, KESHAVGIRI,
VYSAPURI, HYDERABAD-500005.

Vysapuri, Bandlaguda Post, Keshavgi,
Hyderabad-500 005, TELANGANA INDIA
Tel: 040-64596979,8978380692
Fax: 040-24455003
E-mail: principal.mahaveer@gmail.com
Website: www.mist.ac.in.

MAHAVEER

Approved by AICTE. Affiliated to JNTUH,Hyd



Dt:18-01-2020

Event Name: VivekanandaPushpanjaliProgramme

Students Organizing Committee

S NO	STUDENT NAME	BRANCH	YEAR
1.	KEERTHI SAI KRISHNA	IT	IV
2.	P NAVIKANTH CHARY	IT	IV
3.	SRIDHARA GAYATHRI	IT	IV
4.	M SRUJAY REDDY	CSE	IV
5.	P ANUDEEP	CSE	IV
6.	A BHARGAVI	ECE	IV
7.	G HARISH	ECE	IV
8.	G NIKHIL REDDY	ECE	IV
9.	EEGA PRACHYUTH	EEE	IV
10.	L MANIDEEP	AERO	III
11.	VAJEER NARENDHAR	AERO	III
12.	BATHULA RAVITEJA	CIVIL	III
13.	YATHAM SAI YASHASWINI	CIVIL	III
14.	MARAM AKSHITHA	IT	III
15.	BORRA SOMESHWAR REDDY	CSE	III
16.	ANUGU LAXMIKANTH REDDY	CSE	III
17.	SAMUDRALA SAITEJA	CSE	III

K. S. S.
PRINCIPAL
MAHAVEER
INSTITUTE OF SCIENCE & TECHNOLOGY
Bandlaguda, Hyd-500 005.

Vysapuri, Bandlaguda Post:Keshavgiri,
Hyderabad-500 005, TELANGANA INDIA
Tel: 040-64596979,8978380692.
Fax: 040-24455003
E-mail: principal.mahaveer@gmail.com
Website: www.mist.ac.in.

MAHAVEER

Approved by AICTE. Affiliated to JNTUH,Hyd.



ఈనాడు
epaper.eenadu.net

కళాశాల సెక్రటరీని అభినందించిన గవర్నర్



గవర్నర్ నుంచి జ్ఞాపికను అందుకుంటున్న సురేందర్ రెడ్డి

కాటేడాన్, న్యూస్ టుడే: నేతాజీ సుబాష్ చంద్రబోస్ జయంతిని పురస్కరించుచుని రాజేంద్రనగర్ మైలార్ దేవు పల్లి డివిజన్ పల్లెచెరువు మహావీర్ కళాశాల సెక్రటరీ సురేందర్ రెడ్డిని రాష్ట్ర గవర్నర్ సొందరరాజన్ అభినందించారు. నగరంలోని ట్యాంక్ బండ్ లో ఉన్న రామకృష్ణమఠంలో గురువారం జరిగిన ఈ కార్యక్రమంలో ఆమె ఆయన్ను ప్రశంసించారు. ఈనెల 12న వివేకానంద జయంతి నుంచి నేతాజీ జయంతి వరకు వివిధ సామాజిక సేవా కార్యక్రమాలు చేపట్టినందున ప్రశంసాపత్రంతో పాటు జ్ఞాపికను బహుకరించారు.

Date : 24/01/2020 EditionName : TELANGANA(HYDERABAD)
PageNo : Page 06

Kanhu
PRINCIPAL
MAHAVEER
INSTITUTE OF SCIENCE & TECHNOLOGY
Bandlaguda, Hyd-500 005.

2020

Vysapuri, Bandlaguda Post:Keshavgiri,
Hyderabad-500 005, TELANGANA INDIA
Tel: 040-64596979,8978380692,
Fax: 040-24455003
E-mail: principal.mahaveer@gmail.com
Website: www.mist.ac.in,

MAHAVEER

Approved by AICTE, Affiliated to JNTUH,Hyd.



Dt:23-01-2020

Event Name: Be good do good –Ramakrishna math

Organizing Committee

S NO	NAME OF THE FACULTY	DESIGNATION	DEPT
1	Dr M Vasanthaxmi	ASSOCIATE PROFERSSOR	CIVIL

Kanthy
PRINCIPAL
MAHAVEER
INSTITUTE OF SCIENCE & TECHNOLOGY
Bandlaguda, Hyd-500 005

Vysapuri, Bandlaguda Post:Keshavgi,
Hyderabad-500 005, TELANGANA INDIA
Tel: 040-64596979,8978380692.
Fax: 040-24455003
E-mail: principal.mahaveer@gmail.com
Website: www.mist.ac.in,

MAHAVEER

Approved by AICTE. Affiliated to JNTUH,Hyd



Dt:23-01-2020

Event Name: Be good do good –Ramakrishna math

Students Organizing Committee

S NO	STUDENT NAME	BRANCH	YEAR
1	DADIGE SANTHOSH KUMAR	ECE	IV
2	BIJJALA SHRAVANI	ECE	IV
3	JADAV SATHISH	EEE	IV
4	RAJARAPU VIJAY	EEE	IV
5	BADAM ABILASH	CSE	IV
6	MARIKANTI HARIKA REDDY	CSE	IV
7	J NIKITHA	CSE	IV
8	JAKKULA VAMSHI	IT	IV
9	AKULA PRANATHI	IT	IV
10	GAJJELLI VAMSHI KRISHNA	MECH	IV
11	KOTHALAPURAM ANUSHA	MECH	IV
12	GURRAM MANI RUPAK	CSE	III
13	GANECHARY SHREYA	CSE	III
14	BORRA SOMESHWAR REDDY	IT	III
15	KARANKOT KEERTHI	IT	III

K. S. S.
Principal
MAHAVEER
INSTITUTE OF SCIENCE & TECHNOLOGY

Vysapuri, Bandlaguda Post:Keshavgiri,
Hyderabad-500 005, TELANGANA INDIA
Tel: 040-64596979,8978380692.
Fax: 040-24455003
E-mail: principal.mahaveer@gmail.com,
Website: www.mist.ac.in,

MAHAVEER

INSTITUTE OF SCIENCE & TECHNOLOGY
Approved by AICTE, Affiliated to JNTUH,Hyd.



Date: 24-01-2020

CIRCULAR

Sub: National Voters Day Awareness Programme

All the faculty members and students are here by informed that "National Voters Day Awareness Programme" will be organised by NSS unit of Mahaveer Institute Of Science and Technology in Association with JNTUH is scheduled on 25TH JANUARY 2019 between 10:00AM to 2.00PM at JNTUH. Students, teaching and non-teaching staff members are requested to participate this event.

Copy to:

All Hod's, Principal
polytechnic. Exam
Branch incharge,
Librarian

PRINCIPAL

PRINCIPAL
MAHAVEER
INSTITUTE OF SCIENCE & TECHNOLOGY
Bandlaguda, Hyd-500 005.

PRINCIPAL
MAHAVEER
INSTITUTE OF SCIENCE & TECHNOLOGY
Bandlaguda, Hyd-500 005.

Vysapuri, Bandlaguda Post: Keshavgiri,
Hyderabad-500 005, TELANGANA INDIA
Tel: 040-64596979,8978380692
Fax: 040-24455003
E-mail: principal.mahaveer@gmail.com
Website: www.mist.ac.in.

MAHAVEER



Approved by AICTE Affiliated to JNTUH Hyd

25	Activity	National Voters Day Awareness Programme	25-01-2020
----	----------	---	------------

This programme was organized by NSS volunteers MIST on 25th January 2020 the NSS students were conducted pledge on all the class rooms of MIST college campus to aware about voting and importance of a voter on National Voters Day celebrations and the theme of this programme was *Vote for a better Nation*, and after that students were participated in the national voters day celebrations at *Ravindra Bharathi*. The theme of this programme was *Electoral literacy for stronger democracy* organized by Dr. G.narsimha NSS programme coordinator JNTUH.

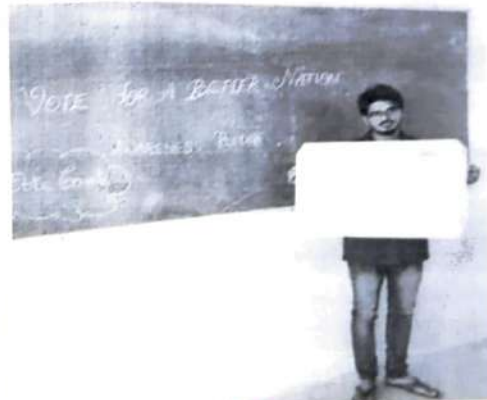

Sulaf
PRINCIPAL
MAHAVEER
INSTITUTE OF MANAGEMENT & TECHNOLOGY
Bandlaguda, Hyd-500 005

Vysapuri, Bandlaguda Post Keshavgiri,
Hyderabad-500 005, TELANGANA INDIA
Tel: 040-64596979, 8978380692
Fax: 040-24455003
E-mail: principal.mahaveer@gmail.com
Website: www.mist.ac.in

MAHAVEER



Approved by AICTE. Affiliated to JNTUH Hyd



Kaishy
MAHAVEER
INSTITUTE OF SCIENCE & TECHNOLOGY
Bandlaguda, Hyd-500 005.

Vysapuri, Bandlaguda Post:Keshavgiri,
Hyderabad-500 005, TELANGANA INDIA
Tel: 040-64596979,8978380692,
Fax: 040-24455003
E-mail: principal.mahaveer@gmail.com
Website: www.mist.ac.in.

MAHAVEER
INSTITUTE OF SCIENCE & TECHNOLOGY
Approved by AICTE, Affiliated to JNTUH,Hyd.



Kishore
PRINCIPAL
MAHAVEER
INSTITUTE OF SCIENCE & TECHNOLOGY
Bandlaguda, Hyd-500 005.

Vysapuri, Bandlaguda Post:Keshavgiri,
Hyderabad-500 005, TELANGANA INDIA
Tel: 040-64596979,8978380692.
Fax: 040-24455003
E-mail: principal.mahaveer@gmail.com
Website: www.mist.ac.in,

MAHAVEER

Approved by AICTE, Affiliated to JNTUH,Hyd.



Dt:25-01-2020

Event Name: National Voters Day Awareness Programme

Students Organizing Committee

S NO	STUDENT NAME	BRANCH	YEAR
1	M VINAY	CSE	II
2	G VISHWATEJ REDDY	ECE	II
3	P VINEETH KUMAR	ECE	II
4	K KARTHIK	ECE	II
5	K RAHUL	AERO	II
6	P PRUTHVI SHANKAR	AERO	II
7	E NAVEEN	EEE	II
8	P PREM SAI	CIVIL	II
9	K KARTHEEK	CIVIL	II

Organizing Committee

S NO	NAME OF THE FACULTY	DESIGNATION	DEPT
1	Dr M Vasanthaxmi	ASSOCIATE PROFERSSOR	CIVIL

K. Subh
PRINCIPAL
MAHAVEER
INSTITUTE OF SCIENCE & TECHNOLOGY
Bandlaguda, Hyd. 500 005

Vysapuri, Bandlaguda Post:Keshavgiri,
Hyderabad-500 005, TELANGANA INDIA
Tel: 040-64596979,8978380692
Fax: 040-24455003
E-mail: principal.mahaveer@gmail.com,
Website: www.mist.ac.in,

MAHAVEER



Approved by AICTE, Affiliated to JNTUH,Hyd.

Date: 24/1/2020

CIRCULAR

Sub: REPUBLIC DAY CELEBRATION

All the faculty members and students are here by informed that "REPUBLIC DAY CELEBRATION " will be organised by NSS unit of Mahaveer Institute Of Science and Technology is scheduled on 26TH JANUARY 2020 between 9.30AM to 3.00PM in our college campus. Students, teaching and non-teaching staff members are requested to participate this event.

PRINCIPAL

PRINCIPAL
MAHAVEER
INSTITUTE OF SCIENCE & TECHNOLOGY
Bandlaguda, Hyd-500 005.

Copy to:

All Hod's, Principal
polytechnic, Exam
Branch incharge,
Librarian

PRINCIPAL
MAHAVEER
INSTITUTE OF SCIENCE & T.
Bandlaguda, Hyd-500 005.

Vysapuri, Bandlaguda Post:Keshavgiri,
Hyderabad-500 005, TELANGANA INDIA
Tel: 040-64596979,8978380692,
Fax: 040-24455003
E-mail: principal.mahaveer@gmail.com
Website: www.mist.ac.in,

MAHAVEER

Approved by AICTE. Affiliated to JNTUH,Hyd.



Event Name: REPUBLIC DAY

ORGANIZING COMMITTEE

S NO	NAME OF THE FACULTY	DESIGNATION	DEPT
1	Dr M Vasanthaxmi	ASSOCIATE PROFERSOR	CIVIL
2	P SAIDIAH	PET	

K. S. S. S.
PRINCIPAL
MAHAVEER
INSTITUTE OF SCIENCE & TECHNOLOGY
Bandlaguda, Hyd-500 005.

Vysapuri, Bandlaguda Post:Keshavgiri,
Hyderabad-500 005, TELANGANA INDIA
Tel: 040-64596979,8978380692,
Fax: 040-24455003
E-mail: principal.mahaveer@gmail.com
Website: www.mist.ac.in,

MAHAVEER

Approved by AICTE, Affiliated to JNTUH,Hyd



Dt:26-01-2020

Event Name: Republic day

NSS PARADE LIST

S NO	STUDENT NAME	BRANCH	YEAR
1	PADMAVATHI PALIWAI	CSE	II
2	M VINAY	CSE	II
3	K. RAMYA	CSE	II
4	R. KALYAN SAI	CSE	II
5	G VISHWATEJ REDDY	ECE	II
6	P VINEETH KUMAR	ECE	II
7	K KARTHIK	ECE	II
8	R SATYASRI RUPA	AERO	II
9	K RAHUL	AERO	II
10	P PRUTHVI SHANKAR	AERO	II
11	N DEEPAK	AERO	II
12	G MAMATHA	IT	II
13	M POOJA	IT	II
14	M MAMATHA	IT	II
15	VAISHALI CHAVAN	EEE	II
16	E NAVEEN	EEE	II
17	SADVIKA	CIVIL	II
18	P PREM SAI	CIVIL	II
19	GURRAM MANI RUPAK	CSE	III
20	GEETHIKA C	CSE	III
21	GANECHARY SHREYA	CSE	III

Dt:26-01-2020

Vysapuri, Bandlaguda Post: Keshavgiri,
Hyderabad-500 005, TELANGANA INDIA
Tel: 040-64596979,8978380692
Fax: 040-24455003
E-mail: principal.mahaveer@gmail.com
Website: www.mist.ac.in.

MAHAVEER



Approved by AICTE. Affiliated to JNTUH,Hyd

26	Activity	Republic day	26-01-2020
----	----------	--------------	------------

On the occasion of *Republic day celebrations at MIST college campus*, NSS Volunteers did the *NSS pared and flag hosting* done by secretary Sri S.Surender Reddy garu and chairmen Sri S.Vijaya Lakshmi Garu, Joint secretary Sri S. Dhanunjay Reddy garu and principal Dr.K.S.S.N Reddy garu in the college campus all the students and faculty members were participated in this occasion after that Other culture activities were conducted and academic toppers taken over certificates by principal and Chairmen.



K.S.S.N

Vysapuri, Bandlaguda Post:Keshavgiri,
Hyderabad-500 005, TELANGANA INDIA
Tel: 040-64596979,8978380692.
Fax: 040-24455003
E-mail: principal.mahaveer@gmail.com,
Website: www.mist.ac.in.

MAHAVEER



Approved by AICTE, Affiliated to JNTUH,Hyd.

Date: 03-03-2020

CIRCULAR

Sub: Traffic Awareness Programme In MIST Campus

All the faculty members and students are hereby informed that "Traffic Awareness Programme In MIST Campus" will be organised by NSS unit of Mahaveer Institute Of Science and Technology in Association with CHARMINAR TRAFFIC POLICE is scheduled on 05TH MARCH 2019 between 9.30AM to 2.00PM in our college campus. Students, teaching and non-teaching staff members are requested to participate this event.

PRINCIPAL

Copy to:
All Hod's, Principal
polytechnic, Exam
Branch incharge,
Librarian

PRINCIPAL
MAHAVEER
INSTITUTE OF SCIENCE & TECHNOLOGY
Bandlaguda, Hyd-500 005.

PRINCIPAL
MAHAVEER
INSTITUTE OF SCIENCE & TECHNOLOGY
Bandlaguda, Hyd-500 005.

Vysapuri, Bandlaguda Post:Keshavgiri,
Hyderabad-500 005, TELANGANA INDIA
Tel: 040-64596979,8978380692,
Fax: 040-24455003
E-mail: principal.mahaveer@gmail.com
Website: www.mist.ac.in.

MAHAVEER

Approved by AICTE, Affiliated to JNTU(H),Hyd



27	5-03-2020	Traffic Awareness Programme In MIST Campus
----	-----------	--

This programme was organized by NSS unit cell MIST at MIST campus on 5th march 2020 by charminar traffic police to give the awareness to the students about traffic rules and regulations, NSS programme coordinator organized this programme in our college campus, The traffic polices roamed in all class rooms of our college in a bid to inculcate road safety issues and spread awareness about the traffic rules among the students.



Traffic Awareness Programme
in Mahaveer Institute of



Keshu

Vysapuri, Bandlaguda Post:Keshavgiri,
Hyderabad-500 005, TELANGANA INDIA
Tel: 040-64596979,8978380692,
Fax: 040-24455003
E-mail: principal.mahaveer@gmail.com
Website: www.mist.ac.in,

MAHAVEER

Approved by AICTE. Affiliated to JNTUH,Hyd



Dt:5-03-2020

Event Name: Traffic Awareness Programme In MIST Campus

Students Organizing Committee

S NO	STUDENT NAME	BRANCH	YEAR
1	M VINAY	CSE	II
2	G VISHWATEJ REDDY	ECE	II
3	P VINEETH KUMAR	ECE	II
4	K KARTHIK	ECE	II
5	K RAHUL	AERO	II
6	P PRUTHVI SHANKAR	AERO	II
7	E NAVEEN	EEE	II
8	P PREM SAI	CIVIL	II
9	K KARTHEEK	CIVIL	II

Organizing Committee

S NO	NAME OF THE FACULTY	DESIGNATION	DEPT
1	Dr M Vasanthaxmi	ASSOCIATE PROFESSOR	CIVIL

PRINCIPAL
MAHAVEER
INSTITUTE OF SCIENCE & TECHNOLOGY
Bandlaguda, Hyd-500 005.

Vysapuri, Bandlaguda Post: Keshavgiri,
Hyderabad-500 005, TELANGANA INDIA
Tel: 040-64596979, 8978380892,
Fax: 040-24455003
E-mail: principal.mahaveer@gmail.com
Website: www.mist.ac.in,

MAHAVEER

Approved by AICTE, Affiliated to JNTUH, Hyd.



INDEX

NSS ACTIVITIES FOR THE AY (2020-2021)

S.NO	EVENT	DATE
1	National voters day at MIST campus	25-01-2021
2	Women's Day Celebrations at MIST campus	08-03-2021
3	Covid Testing and vaccination at MIST	09-04-2021 to 10-04-2-21
4	International YOGA day Celebrations at MIST	21-06-2021

PRINCIPAL
MAHAVEER
INSTITUTE OF SCIENCE & TECHNOLOGY
Bandlaguda, Hyd-500 005.

Vysapuri, Bandlaguda Post, Keethavgiri,
Hyderabad-500 005, TELANGANA INDIA
Tel: 040-64596979, 8978380692.
Fax: 040-24455003
E-mail: principal.mahaveer@gmail.com,
Website: www.mist.ac.in.

MAHAVEER

Approved by AICTE, Affiliated to JNTUH, Hyd.



Date: 23/1/2021

CIRCULAR

Sub: National voters day at mist campus

All the faculty members and students are here by informed that "National voters day at mist campus" will be organised by NSS unit of Mahaveer Institute Of Science and Technology is scheduled on 25TH JANUARY 2018 between 9.30AM to 2.00PM in our college campus. Students, teaching and non-teaching staff members are requested to participate this event.

PRINCIPAL

Copy to:

All Hod's, Principal
polytechnic, Exam
Branch incharge,
Librarian

PRINCIPAL
MAHAVEER
INSTITUTE OF SCIENCE & TECHNOLOGY
Bandlaguda, Hyd-500 005.

Vysapuri, Bandlaguda Post:Keshavgi,
Hyderabad-500 005, TELANGANA INDIA
Tel: 040-64596979,8978380692,
Fax: 040-24455003
E-mail: principal.mahaveer@gmail.com
Website: www.mist.ac.in,

MAHAVEER
INSTITUTE OF SCIENCE & TECHNOLOGY
Approved by AICTE, Affiliated to JNTUH,Hyd.



Dt:25-01-2021

Programme 1 : National voters day at MIST campus

This programme was organized by NSS Unit Of Mahaveer Institute Of Science And Technology an online webinar is conducted on 25 January 2021 the speaker of this programme was **prof. k. Purushotham Reddy** Garu he is an Eminent Environmentalist, Academician, development Activist and political scientist

 profkprfoundation.com

KPR Foundation | An initiative by Prof. K. Purushotham Reddy

A great visionary Prof. K. Purushotham Reddy, who is an Eminent Environmentalist, Academician, Development Activist and Political Scientist ...



You visited this page on 24/1/21.

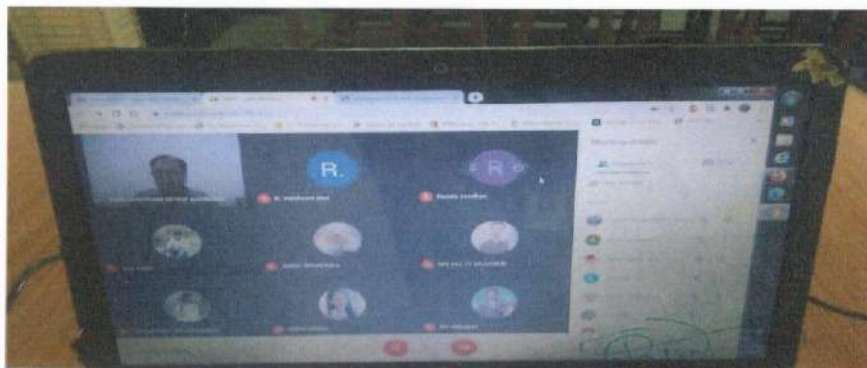

PRINCIPAL
MAHAVEER
INSTITUTE OF SCIENCE & TECHNOLOGY

Vysapuri, Bandlaguda Post:Keshavgi,
Hyderabad-500 005, TELANGANA INDIA
Tel: 040-64596979,8978380692,
Fax: 040-24455003
E-mail: principal.mahaveer@gmail.com,
Website: www.mist.ac.in,

MAHAVEER

Approved by AICTE, Affiliated to JNTUH.Hyd.



Date: 06/3/2021

CIRCULAR

Sub: Womens day celebration at mist campus

All the faculty members and students are here by informed that "Womens day celebration at mist campus" will be organised by NSS unit of Mahaveer Institute Of Science and Technology is scheduled on 8TH MARCH 2021 between 9.30AM to 2.00PM in our college campus. Students, teaching and non-teaching staff members are requested to participate this event.

PRINCIPAL

Copy to:
All Hod's, Principal
polytechnic, Exam
Branch incharge,
Librarian

PRINCIPAL
MAHAVEER
INSTITUTE OF SCIENCE & TECHNOLOGY
Bandlaguda, Hyd-500 005.

Vysapuri, Bandlaguda Post:Keshavgiri,
Hyderabad-500 005, TELANGANA INDIA
Tel: 040-64596979,8978380692,
Fax: 040-24455003
E-mail: principal.mahaveer@gmail.com
Website: www.mist.ac.in,

MAHAVEER

Approved by AICTE. Affiliated to JNTUH,Hyd.



Dt:25-01-2021

Event Name: National voter's day at MIST campus

Organizing committee

Student organizing members:

S NO	STUDENT NAME	BRANCH	year
1	M VINAY KUMAR REDDY	CSE	III
2	B RAMA NAIK	MECH	III
3	MADARAM GOURISHANKAR	AERO	III

Faculty organizing members:

S NO	NAME OF THE FACULTY	DESIGNATION	DEPT
1	Dr M Vasantha laxmi	ASSOCIATE PROFESSOR	CIVIL

PRINCIPAL
MAHAVEER
INSTITUTE OF SCIENCE & TECHNOLOGY
Bandlaguda, Hyd-500 005.

Vysapuri, Bandlaguda Post:Keshavgi,
Hyderabad-500 005, TELANGANA INDIA
Tel: 040-64596979,8978380692.
Fax: 040-24455003
E-mail: principal.mahaveer@gmail.com
Website: www.mlst.ac.in,

MAHAVEER

Approved by AICTE. Affiliated to JNTUH.Hyd



82	MURIKINATI RAJESWARI	AERO	II
83	SRAVAN KUMAR SINGH	AERO	II

PRINCIPAL
MAHAVEER
INSTITUTE OF SCIENCE & TECHNOLOGY
Bandlaguda, Hyd-500 005.

Vysapuri, Bandlaguda Post: Keshavgirl,
Hyderabad-500 005, TELANGANA INDIA
Tel: 040-64596979, 8978380692,
Fax: 040-24455003
E-mail: principal.mahaveer@gmail.com
Website: www.mist.ac.in,

MAHAVEER

Approved by AICTE, Affiliated to JNTUH Hyd



54	MADARAM GOURISHANKAR	AERO	III
55	D SAKETH	CIVIL	II
56	JUVERIA MAHVEEN	CIVIL	II
57	N SHIVA SHANKER	CIVIL	II
58	T DEEPTHI	EEE	II
59	GANDHAM DEEPAK	EEE	II
60	MOGILI MANJULA	EEE	II
61	MD AVEZ	MECH	II
62	THODETI REVANTH	MECH	II
63	PUTALA BHUPAL	ECE	II
64	SOMAYAJULA KAVYA	ECE	II
65	VAIDA YASHWANTH	ECE	II
66	GAJJI LAHARI	ECE	II
67	ALCHETI PRAPUL	CSE	II
68	M RAVI TEJA	CSE	II
69	MADDENI UDAY	CSE	II
70	PULIMAMIDI AKHILA	CSE	II
71	YERRAGUNTLA SINDHU	CSE	II
72	GALIPELLI HARSHINI	CSE	II
73	NEHA KUMARI	CSE	II
74	PUDUTHA DIVYA	CSE	II
75	ANISHETTY VARSHITHA	IT	II
76	KARNE MANIKANTA	IT	II
77	SEELAM SAI CHARAN REDDY	IT	II
78	VEMPATI NAVYA TEJ	IT	II
79	GATTU MANISH	AERO	II
80	K KOUSHIK	AERO	II
81	MACCHA TARUNTEJA	AERO	II

PRINCIPAL

M. MAHAVEER
INSTITUTE OF SCIENCE & TECHNOLOGY

Vysapuri, Bandlaguda Post:Keshavgiri,
Hyderabad-500 005, TELANGANA INDIA
Tel: 040-84596979,8978380692,
Fax: 040-24455003
E-mail: principal.mahaveer@gmail.com
Website: www.mlst.ac.in,

MAHAVEER

Approved by AICTE. Affiliated to JNTUH Hyd



25	C K NIKHIL SWAROOP	CSE	III
26	MANCHI SANKEERTH	CSE	III
27	MEDI RAJESH	CSE	III
28	BANOTHU DIVYA	MECH	III
29	YEPURI PRASHANTH	MECH	III
30	JANGA SAIKRISHNA	MECH	III
31	DANDA DEEKSHITHA	ECE	III
32	MUDUMBAI SRINIVASA VISHNU TEJA	ECE	III
33	NALLAMOTHU TEJA	ECE	III
34	RAIKANTI RAKESH	ECE	III
35	VEGINATI TRIVENI	ECE	III
36	CHALLA AKHILA	ECE	III
37	CHINTALA GAYATHRI	ECE	III
38	GORATI AKILA	ECE	III
39	KANDULA SAI KUMAR	ECE	III
40	BALAI SRUJAN	CSE	III
41	CHANDRADITHYA	CSE	III
42	M VINAY KUMAR REDDY	CSE	III
43	PADMAVATHI	CSE	III
44	PILLI NAGENDAR	CSE	III
45	PANDALA NIKITHA	CSE	III
46	SUTHARI SHWETHA	CSE	III
47	AMUDALA SHRAVAN GOUD	IT	III
48	AINDLA ABHISHEK	IT	III
49	CHIMATA AKHILA	IT	III
50	GYADA MAMATHA	IT	III
51	POLKAM PUSHPALATHA	IT	III
52	KURUMETI HYMAVATHI	AERO	III
53	KOLA IMMANUEL	AERO	III

(Handwritten signature)

PRINCIPAL
MAHAVEER

Vysapuri, Bandlaguda Post:Keshavgiri,
Hyderabad-500 005, TELANGANA INDIA
Tel: 040-64596979,8978380692,
Fax: 040-24455003
E-mail: principal.mahaveer@gmail.com
Website: www.mist.ac.in,

MAHAVEER

INSTITUTE OF SCIENCE & TECHNOLOGY
Approved by AICTE, Affiliated to JNTUH, Hyd.



Dt:25-01-2021

Event Name: National voter's day at MIST campus

Student participation list

S NO	STUDENT NAME	BRANCH	year
1	D SRAVANI	ECE	IV
2	GUNUGANTI SPOORTHI	ECE	IV
3	BHUKYA PRAVEEN KUMAR	ECE	IV
4	PADAMATI NIKITH REDDY	ECE	IV
5	MOHD BURHAN UDDIN	ECE	IV
6	VSS VYBHAV	CSE	IV
7	R BHAVANI	CSE	IV
8	K ANAND	CSE	IV
9	SOMESHWAR	CSE	IV
10	J MANASA	CSE	IV
11	D SRIKANTH	CSE	IV
12	R MANIRUPAK	CSE	IV
13	D ANUSHA	CSE	IV
14	BANOTHU ASHOK	EEE	IV
15	VENNAMPELLI SANDEEP	EEE	IV
16	DHARAVATH KALYAN	CIVIL	III
17	GURRAPUSALA VINITH	CIVIL	III
18	RAMAGIRI CHARAN	CIVIL	III
19	SOMARAM AKASH	CIVIL	III
20	ELEMELA SHIVANI	EEE	III
21	PADITHAPU SHASHANK	EEE	III
22	SHAIK RAFI	EEE	III
23	MUSKAN PRIYA	EEE	III
24	ADNAN ALI AHMED	CSE	III

PRINCIPAL
MAHAVEER

Vysapuri, Bandlaguda Post:Keshavgi,
Hyderabad-500 005, TELANGANA INDIA
Tel: 040-64596979,8978380692,
Fax: 040-24455003
E-mail: principal.mahaveer@gmail.com
Website: www.mist.ac.in,

MAHAVEER

Approved by AICTE. Affiliated to JNTUH.Hyd.



Dt:08-03-2021

Programme 2 : Women's Day Celebrations at MIST campus

This programme was organized by our college NSS programme officer at MIST college campus on 8th march 2021, The guest's of this programme were **Lt.col.Swarna Mettu Reddy garu and Mrs.Vijaya Bharathi garu senior Advocate**, For this programme Our college Chairmen Sri S.Jayalkshmi garu , NSS programme officer Dr.M Vasantha Lakshmi garu were participated along with all the lady faculty members as well as women staff in the college, all the women faculty members were inspired by the speech given by Vijaya Bharathi garu and Swarna mittu Reddy garu, after that some cultural events conducted on that day.

PRINCIPAL
MAHAVEER
INSTITUTE OF SCIENCE & TECHNOLOGY
Bandlaguda, Hyd-500 005.

Vysapuri, Bandlaguda Post:Keshavgi,
Hyderabad-500 005, TELANGANA INDIA
Tel: 040-64596979,8978380692,
Fax: 040-24455003
E-mail: principal.mahaveer@gmail.com
Website: www.mist.ac.in,

MAHAVEER

INSTITUTE OF SCIENCE & TECHNOLOGY

Approved by AICTE, Affiliated to JNTUH,Hyd.



ESTD : 2001

MAHAVEER

INSTITUTE OF SCIENCE & TECHNOLOGY

Approved by AICTE, Affiliated to JNTU, Hyderabad.

Vyasapuri, Bandlaguda, Post: Keshavgi, Hyderabad-500005.



Lt.col.Swarna Mettu Reddy garu



Mrs. Vijaya Bharathi garu
Senior Advocate

PRINCIPAL
MAHAVEER

Vysapuri, Bandlaguda Post:Keshavgi,
Hyderabad-500 005, TELANGANA INDIA
Tel: 040-64596979,8978380692,
Fax: 040-24455003
E-mail: principal.mahaveer@gmail.com
Website: www.mist.ac.in,

MAHAVEER
INSTITUTE OF SCIENCE & TECHNOLOGY
Approved by AICTE, Affiliated to JNTUH,Hyd.



PRINCIPAL
MAHAVEER
INSTITUTE OF SCIENCE & TECHNOLOGY
Bandlaguda, Hyd-500 005.

Vysapuri, Bandlaguda Post:Keshavgiri,
Hyderabad-500 005, TELANGANA INDIA
Tel: 040-64596979,8978380692,
Fax: 040-24455003
E-mail: principal.mahaveer@gmail.com
Website: www.mist.ac.in,

MAHAVEER

Approved by AICTE, Affiliated to JNTUH,Hyd



Dt: 08-03-2021

EVENT : Women's Day Celebrations at MIST campus

Organizing committee

Student organizing members:

S NO	STUDENT NAME	BRANCH	year
1	PADMAVATHI PALIWAL	CSE	III
2	RALLABANDI SATYA SREE RUPA	AERO	III
3	NELLORE SIVA JYOTHI	ECE	III

Faculty organizing members:

S NO	NAME OF THE FACULTY	DESIGNATION	DEPT
1	Dr M Vasantha laxmi	ASSOCIATE PROFERSOR	CIVIL

PRINCIPAL
MAHAVEER
INSTITUTE OF SCIENCE & TECHNOLOGY
Bandlaguda, Hyd-500 005.

Vysapuri, Bandlaguda Post:Keshavgiri,
Hyderabad-500 005, TELANGANA INDIA
Tel: 040-64596979,8978380692.
Fax: 040-24455003
E-mail: principal.mahaveer@gmail.com
Website: www.mist.ac.in,

MAHAVEER

Approved by AICTE, Affiliated to JNTUH, Hyd.



Dt:08-03-2021

EVENT : Women's Day Celebrations at MIST campus

Participation list

S NO	NAME OF THE FACULTY	DEPT
1	A SARALADEVI	CSE
2	M SWAPNA	CSE
3	M SRIVIDHYA	CSE
4	G MANASA	CSE
5	G SOWJANYA	CSE
6	D SUNITHA	ECE
7	R PRIYANKA	ECE
8	K ARCHANA	ECE
9	G SOWJANYA	ECE
10	KIRPAULKOUR	ECE
11	HIMAJA	ECE
12	E SARASWATHI	EEE
13	K DIVYA	EEE
14	M JYOTHI	EEE
15	R HIMABINDU	EEE
16	ARSHYA	EEE
17	BHARGHAVI	EEE
18	KVBK NAGASREE	IT
19	D PRIYANKA	IT
20	G BHAVANI	MECH
21	K VARALKSHMI	CIVIL
22	HEMALATHA	CIVIL
23	RAMYA	CIVIL
24	ANITHA	CIVIL

PRINCIPAL
MAHAVEER
INSTITUTE OF SCIENCE & TECHNOLOGY
Bandlaguda, Hyd-500 005.

Vysapuri, Bandlaguda Post, Keshavgiri,
Hyderabad-500 005, TELANGANA INDIA
Tel: 040-64596979, 8978380692
Fax: 040-24455003
E-mail: principal.mahaveer@gmail.com,
Website: www.mist.ac.in.

MAHAVEER



Approved by AICTE, Affiliated to JNTUH, Hyd.

Date: 07/3/2021

CIRCULAR

Sub: COVID TESTING AND VACCINATION AT MIST CAMPUS

All the faculty members and students are here by informed that "COVID TESTING AND VACCINATION AT MIST CAMPUS" will be organised by NSS unit of Mahaveer Institute Of Science and Technology is scheduled on 9TH & 10TH APRIL 2021 between 10:0AM to 4.00PM in our college campus teaching and non-teaching staff members are requested to participate this event.

PRINCIPAL

Copy to:
All Hod's, Principal
polytechnic, Exam
Branch incharge,
Librarian

PRINCIPAL
MAHAVEER
INSTITUTE OF SCIENCE & TECHNOLOGY
Bandlaguda, Hyd-500 005.

Vysapuri, Bandlaguda Post:Keshavgiri,
Hyderabad-500 005, TELANGANA INDIA
Tel: 040-64596979,8978380692,
Fax: 040-24455003
E-mail: principal.mahaveer@gmail.com
Website: www.mist.ac.in,

MAHAVEER
INSTITUTE OF SCIENCE & TECHNOLOGY
Approved by AICTE, Affiliated to JNTUH,Hyd.



PRINCIPAL
MAHAVEER
INSTITUTE OF SCIENCE & TECHNOLOGY
Bandlaguda, Hyd-500 005.

Vysapuri, Bandlaguda Post:Keshavgi,
Hyderabad-500 005, TELANGANA INDIA
Tel: 040-64596979,8978380692,
Fax: 040-24455003
E-mail: principal.mahaveer@gmail.com
Website: www.mist.ac.in,

MAHAVEER
INSTITUTE OF SCIENCE & TECHNOLOGY
Approved by AICTE, Affiliated to JNTUH,Hyd.



Dt:09-04-2021 to 10-04-2-21

Programme 3: Covid Testing and vaccination at MIST

Mahaveer Institute of science and Technology organized Covid Testing and vaccination programme at college campus on April 9th and 10th 2021 with the help of Primary Health care center bandlaguda. Dr.Jhansi look out all these testing and vaccination with their supporting staff on this day all the faculty, and staff members of Mahaveer group of institutions were participated and vaccinated who got negative reports in their covid testing not only the staff it was very helpful to out side people who are staying near by the college premises and family members of staff of mahaveer group of institutions.





PRINCIPAL
MAHAVEER
INSTITUTE OF SCIENCE & TECHNOLOGY
Bandlaguda, Hyd-500 005.

Vysapuri, Bandlaguda Post:Keshavgi,
Hyderabad-500 005, TELANGANA INDIA
Tel: 040-64596979,8978380692.
Fax: 040-24455003
E-mail: principal.mahaveer@gmail.com
Website: www.mist.ac.in,

MAHAVEER
INSTITUTE OF SCIENCE & TECHNOLOGY
Approved by AICTE, Affiliated to JNTUH,Hyd.



PRINCIPAL
MAHAVEER
INSTITUTE OF SCIENCE & TECHNOLOGY
Bandlaguda, Hyd-500 005.

Vysapuri, Bandlaguda Post:Keshavgiri,
Hyderabad-500 005, TELANGANA INDIA
Tel: 040-64596979,8978380692,
Fax: 040-24455003
E-mail: principal.mahaveer@gmail.com
Website: www.mist.ac.in,

MAHAVEER

INSTITUTE OF SCIENCE & TECHNOLOGY
Approved by AICTE. Affiliated to JNTUH,Hyd.



Dt: 09-04-2021 to 10-04-2-21

EVENT: Covid Testing and vaccination at MIST

Organizing committee

Faculty organizing members:

S NO	NAME OF THE FACULTY	DESIGNATION	DEPT
1	Dr M Vasantha laxmi	ASSOCIATE PROFESSOR	CIVIL

PRINCIPAL
MAHAVEER
INSTITUTE OF SCIENCE & TECHNOLOGY
Bandlaguda, Hyd-500 005.

Vysapuri, Bandlaguda Post:Keshavgiri,
Hyderabad-500 005, TELANGANA INDIA
Tel: 040-64596979,8978380692,
Fax: 040-24455003
E-mail: principal.mahaveer@gmail.com
Website: www.mist.ac.in,

MAHAVEER

INSTITUTE OF SCIENCE & TECHNOLOGY
Approved by AICTE, Affiliated to JNTUH,Hyd.



80.	PRAMODA HOLISTER	MBA
81.	B KISHORE	MBA

A handwritten signature in blue ink, appearing to be 'Principals'.

PRINCIPAL
MAHAVEER
INSTITUTE OF SCIENCE & TECHNOLOGY
Bandlaguda, Hyd-500 005.

Vysapuri, Bandlaguda Post:Keshavgiri,
Hyderabad-500 005, TELANGANA INDIA
Tel: 040-64596979,8978380692,
Fax: 040-24455003
E-mail: principal.mahaveer@gmail.com
Website: www.mist.ac.in,

MAHAVEER

Approved by AICTE. Affiliated to JNTUH,Hyd



35.	K NANDAGOPAL REDDY	IT
36.	NARESH	IT
37.	DEVENDER	IT
38.	B MALLAIAH	IT
39.	SIDDI SRINIVAS	IT
40.	KVBK NAGASREE	IT
41.	D PRIYANKA	IT
42.	B VENKATESHWAR REDDY	MECH
43.	PRAVEEN	MECH
44.	FAIZ ALI	MECH
45.	DEVI SINGH	MECH
46.	SANTHOSH	MECH
47.	SHAHANSHA	MECH
48.	B NAGESHWAR	MECH
49.	G BHAVANI	MECH
50.	KRISHNA DEEPAK	MECH
51.	SWETHAMBAR	CIVIL
52.	SAI SAGAR	CIVIL
53.	K VARALKSHMI	CIVIL
54.	HEMALATHA	CIVIL
55.	RAMYA	CIVIL
56.	ANITHA	CIVIL
57.	MALLESH	AERO
58.	NAVEEN	AERO
59.	RAJENDER	AERO
60.	MAHESH	AERO
61.	SUDHARSHAN	AERO
62.	DINESH	AERO
63.	NAGARAJU	H&S
64.	MADHUSUDHAN	H&S
65.	MAHENDRAVARMA	H&S
66.	MADHAVA RAO	H&S
67.	RAVINDER REDDY	H&S
68.	ANIL	H&S
69.	ANAND	H&S
70.	PRAKASH	H&S
71.	YELLAIAH	H&S
72.	RAGINI	H&S
73.	JAYA SREE	H&S
74.	MADHAVI	H&S
75.	LATHA	H&S
76.	PRATHIBHA	H&S
77.	RAJESH	MBA
78.	KS ARCHANA	MBA
79.	SANA	MBA

(Signature)

PRINCIPAL
MAHAVEER
INSTITUTE OF SCIENCE & TECHNOLOGY
Bandlaguda, Hyd-500 005.

Vysapuri, Bandlaguda Post:Keshavgiri,
Hyderabad-500 005, TELANGANA INDIA
Tel: 040-64596979,8978380692,
Fax: 040-24455003
E-mail: principal.mahaveer@gmail.com
Website: www.mist.ac.in,

MAHAVEER

Approved by AICTE, Affiliated to JNTUH,Hyd



Dt: 09-04-2021 to 10-04-21

EVENT: Covid Testing and vaccination at MIST

Participation list

S NO	NAME OF THE FACULTY	DEPT
1.	B SEVA NAIK	CSE
2.	M SREENIVAS REDDY	CSE
3.	K GIRIBABU	CSE
4.	MUNEER AHMED	CSE
5.	N ASHWAN	CSE
6.	G SANTHOSH	CSE
7.	A SARALADEVI	CSE
8.	M SWAPNA	CSE
9.	M SRIVIDHYA	CSE
10.	G MANASA	CSE
11.	G SOWJANYA	CSE
12.	M CHEENYA	ECE
13.	M SREENU	ECE
14.	B SREENU	ECE
15.	G SUREBDER	ECE
16.	K. VENKATESHWARLU	ECE
17.	R PRABHAKAR	ECE
18.	N SANDEEP	ECE
19.	M PRASHANTH	ECE
20.	D SUNITHA	ECE
21.	R PRIYANKA	ECE
22.	K ARCHANA	ECE
23.	G SOWJANYA	ECE
24.	KIRPAULKOUR	ECE
25.	HIMAJA	ECE
26.	E SARASWATHI	EEE
27.	K DIVYA	EEE
28.	M JYOTHI	EEE
29.	R HIMABINDU	EEE
30.	ARSHYA	EEE
31.	BHARGHAVI	EEE
32.	N MAHESH	EEE
33.	PREM KUMAR	EEE
34.	SUDHAKARAN	EEE

Principal
M. S. J. P.
INSTITUTE OF SCIENCE & TECHNOLOGY
Bandlaguda, Hyd-500 005.

Vysapuri, Bandlaguda Post:Keshavgiri,
Hyderabad-500 006, TELANGANA INDIA
Tel: 040-84598979,8978380892.
Fax: 040-24455003
E-mail: principal.mahaveer@gmail.com,
Website: www.mist.ac.in,

MAHAVEER



Approved by AICTE, Affiliated to JNTUH,Hyd.

Date: 19/6/2021

CIRCULAR

Sub: INTERNATIONAL YOGA DAY CELEBRATION AT MIST CAMPUS

All the faculty members and students are here by informed that "INTERNATIONAL YOGA DAY CELEBRATION AT MIST CAMPUS" will be organised by NSS unit of Mahaveer Institute Of Science and Technology in Association with SAMSKRUTHI FOUNDATION is scheduled on 21ST JUNE 2021 between 9.30AM to 2.00PM in our college campus. Students, teaching and non-teaching staff members are requested to participate this event.

PRINCIPAL

Copy to:
All Hod's, Principal
polytechnic, Exam
Branch incharge,
Librarian

PRINCIPAL
MAHAVEER
INSTITUTE OF SCIENCE & TECHNOLOGY
Bandlaguda, Hyd-500 006.

Vysapuri, Bandlaguda Post:Keshavgiri,
Hyderabad-500 005, TELANGANA INDIA
Tel: 040-64596979,8978380692,
Fax: 040-24455003
E-mail: principal.mahaveer@gmail.com
Website: www.mist.ac.in,

MAHAVEER
INSTITUTE OF SCIENCE & TECHNOLOGY
Approved by AICTE, Affiliated to JNTUH,Hyd.



Date: 21-06-2021

Programme 4: International YOGA day Celebrations at MIST

International Yoga day was celebrated on Mahaveer Institute Of Science and Technology, Our college NSS program officer **Dr.M vasantha lakhmi** participated in online webinar along with the students and faculty members organized by **Samskruthi Foundation** the speaker of the programme was **CSR Prabhu Garu Director General Of National Informatics Centre(Nic), New Delhi (Retd) Delhi**, after completion of this programme the faculty members of MIST were participated in the YOGA program and they did some yoga Asana's also.

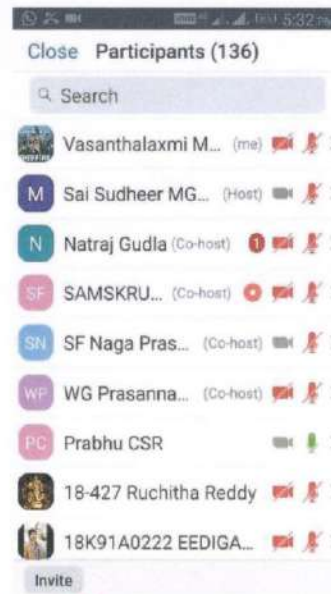

Dr. M. Vasantha Lakhmi
PRINCIPAL
MAHAVEER
INSTITUTE OF SCIENCE & TECHNOLOGY
Bandlaguda, Hyd-500 005.

Vysapuri, Bandlaguda Post:Keshavgi,
Hyderabad-500 005, TELANGANA INDIA
Tel: 040-64596979,8978380692,
Fax: 040-24455003
E-mail: principal.mahaveer@gmail.com
Website: www.mist.ac.in,

MAHAVEER
INSTITUTE OF SCIENCE & TECHNOLOGY
Approved by AICTE, Affiliated to JNTUH,Hyd.

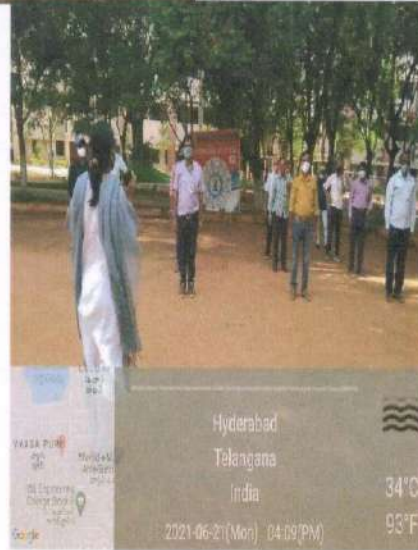
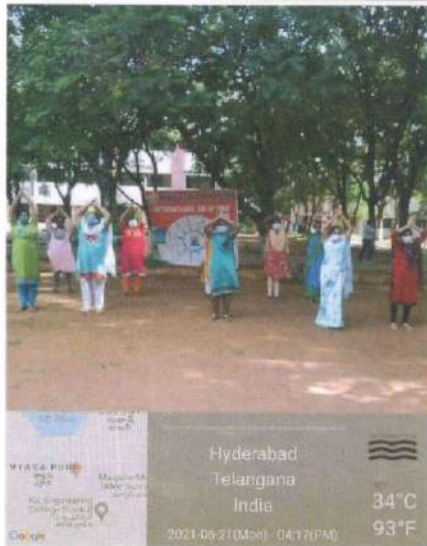
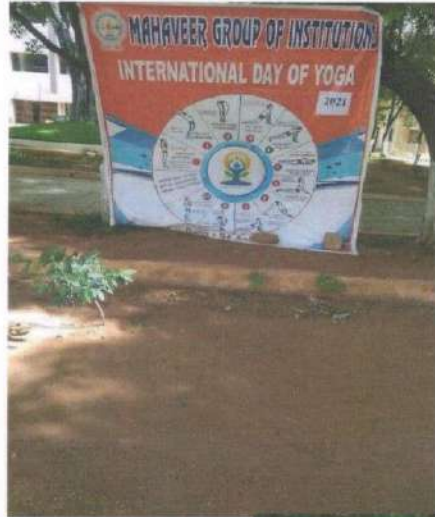

Principal Mahaveer
**PRINCIPAL
MAHAVEER**
INSTITUTE OF SCIENCE & TECHNOLOGY

Vysapuri, Bandlaguda Post:Keshavgi,
Hyderabad-500 005, TELANGANA INDIA
Tel: 040-64596979,8978380692,
Fax: 040-24455003
E-mail: principal.mahaveer@gmail.com
Website: www.mist.ac.in,

MAHAVEER
INSTITUTE OF SCIENCE & TECHNOLOGY
Approved by AICTE, Affiliated to JNTUH,Hyd.

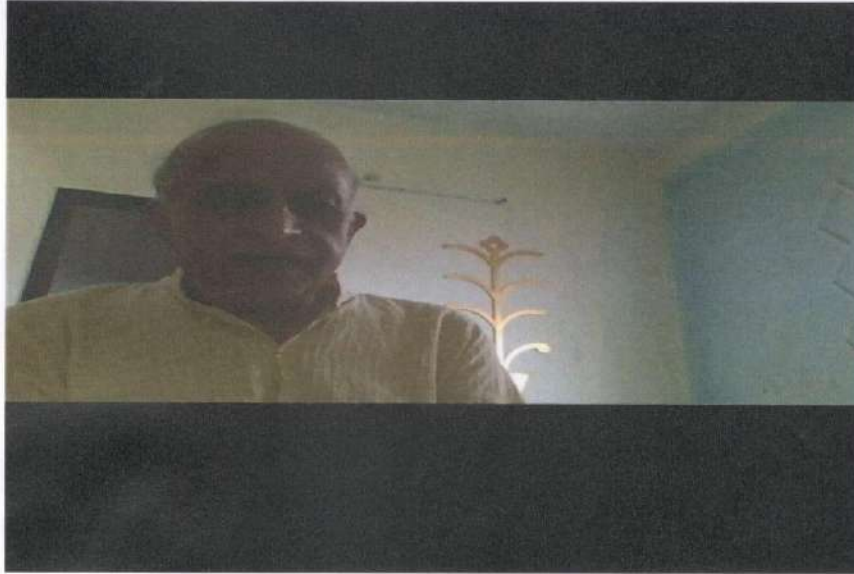

PRINCIPAL
MAHAVEER
INSTITUTE OF SCIENCE & TECHNOLOGY
Bandlaguda, Hyd-500 005.

Vysapuri, Bandlaguda
Post:Keshavgi, Hyderabad- 500005,
Telangana, INDIA
Tel: 040-29880086,8978380692,Fax:040-24550033
E-mail: principal@mist.ac.in
principal.mahaveer@gmail.com,
Website: www.mist.ac.in,

MAHAVEER
INSTITUTE OF SCIENCE & TECHNOLOGY
Approved by AICTE, Affiliated to JNTUH,Hyd.



Counseling Code: **MHVR**, University Code: **E3**

7.2.1 II Best practices :Add on courses

Objectives :

- ❖ To offer add-on specialized courses along with the B.Tech degree. It would help students to gain cutting edge technologies to meet the expectations of industry.
- ♦ To give practical, hands-on and industry ready training by world class
- ♦ efficient trainers. To provide Internships to the meritorious students.
- ♦ To help the students of MIST to secure high paying quality jobs in best of MNC's.

Vysapuri, Bandlaguda Post:Keshavgi,Hyderabad-500 005,
Telangana, INDIA

Tel: 040-29880086,8978380692.Fax: 040-24455003

E-mail: principal@mist.ac.in, principal.mahaveer@gmail.com

Website: www.mist.ac.in,

Counselling Code: **MHVR**, University Code: **E3**

MAHAVEER
INSTITUTE OF SCIENCE & TECHNOLOGY



Approved by AICTE, Affiliated to JNTU,H,Hyd.

Number of Add on /Certificate programs offered during the last five years

1.2.3 Average percentage of students enrolled in Add-on/Certificate programs as against the total number of students during the last five years

Name of Add on /Certificate programs offered	Course Code (if any)	Year -1					Number of Students completing the course in the year
		Year of offering	No. of times offered during the same year	Duration of course	Number of students enrolled in the year		
E-TABS	CIVIL-ET	2020-2021	1	30Hrs	48	48	
AUTO CAD	CIVIL-AC	2020-2021	1	36Hrs	36	36	
REVIT	CIVIL-R	2020-2021	1	38Hrs	36	36	
GEO5	CIVIL-G5	2020-2021	1	40Hrs	39	39	
STAAD-PRO	CIVIL-SP	2020-2021	1	30Hrs	39	39	
AUTO CAD	EEE-AC	2020-2021	1	30Hrs	31	31	
MAT CAD PROGRAMMING	EEE-MATCADP	2020-2021	1	36Hrs	35	35	
AUTO CAD	MECH-AUTOCAD	2020-2021	1	30Hrs	21	21	
CATIA	MECH-CATIA	2020-2021	1	30Hrs	60	60	
ANSYS	MECH-ANSYS	2020-2021	1	30Hrs	75	75	
3D-PRINTING	MECH-3D PRINTING	2020-2022	1	30Hrs	75	75	
CNC	MECH-CNC	2020-2021	1	30Hrs	18	18	
ROLE ON ADVANCED ELECTRONIC MATERIALS & DEVICES IN SPACE & DEFENCE APPLICATIONS	ECE-AEMSDA	2020-2021	1	30Hrs	47	47	
PYTHON PROGRAMMING	ECE-PP	2020-2021	1	30Hrs	47	47	
3DGRAPHICS	CSE-3DG	2020-2021	1	36Hrs	53	53	
PYTHON PROGRAMMING	IT-PP	2020-2021	1	30Hrs	53	53	
ADVANCE JAVA AND J2EE USING ECLIPSE	IT-AJ-J2EE	2020-2021	1	30Hrs	67	67	
MULTI ROTOR DRONE PILOT	AERO-MRDP	2020-2021	1	30Hrs	33	33	
ULTRASONICS	HNS-US	2020-2021	1	36Hrs	25	25	

Year 2

Name of Add on /Certificate programs offered	Course Code (if any)	Year of offering	No. of times offered during the same year	Duration of course	Number of students enrolled in the year	Number of Students completing the course in the year
E-TABS	CIVIL-ET	2019-2020	1	30Hrs	40	40
AUTO CAD	CIVIL-AC	2019-2020	1	36Hrs	56	56
REVIT	CIVIL-R	2019-2020	1	38Hrs	45	45
MATLAB PROGRAMMING	EEE-MATLP	2019-2020	1	30Hrs	46	46
PSPICE PROGRAMMING	EEE-PSP	2019-2020	1	30Hrs	35	35
AUTO CAD	MECH-AUTOCAD	2019-2020	1	30Hrs	60	60
CATIA	MECH-CATIA	2019-2020	1	30Hrs	75	75
ANSYS	MECH-ANSYS	2019-2020	1	30Hrs	78	78
MATERIALS & DEVICES IN SPACE &	ECE-AEMDSDA	2019-2020	1	30Hrs	50	50
ADVANCED VLSI TECHNOLOGY	ECE-AVT	2019-2020	1	40Hrs	50	50
BASIC WEB DESIGNING	CSE-BWD	2019-2020	1	30Hrs	67	67
ANDROID APPLICATION DEVELOPMENT	IT-AAD	2019-2020	1	40Hrs	50	50
ORACLE JAVA CERTIFICATION	IT-OJC	2019-2020	1	30Hrs	49	49
COMPUTER AIDED ANALYSIS FLUENT	AERO-FLUENT	2019-2020	1	30Hrs	24	24
SOFTSKILLS	HNS-SS	2019-2020	1	36Hrs	25	25
Year 3						
Name of Add on /Certificate programs offered	Course Code (if any)	Year of offering	No. of times offered during the same year	Duration of course	Number of students enrolled in the year	Number of Students completing the course in the year
AUTO CAD	CIVIL-AC	2018-2019	1	36Hrs	38	38
REVIT	CIVIL-R	2018-2019	1	38Hrs	38	38
GEO5	CIVIL-G5	2018-2019	1	40Hrs	35	35
STAAD-PRO	CIVIL-SP	2018-2019	1	30Hrs	35	35
PLC PROGRAMMING	EEE-PLCP	2018-2019	1	30Hrs	37	37
ELECTRICAL ENERGY MANAGEMENT	EEE-EEM	2018-2019	1	30Hrs	46	46
AUTO CAD	MECH-AUTOCAD	2018-2019	1	30Hrs	75	75
CATIA	MECH-CATIA	2018-2019	1	30Hrs	78	78
ANSYS	MECH-ANSYS	2018-2019	1	30Hrs	70	70
MATERIALS & DEVICES IN SPACE &	ECE-AEMDSDA	2018-2019	1	40Hrs	53	53
ADVANCED VLSI TECHNOLOGY	ECE-AVT	2018-2019	1	30Hrs	51	51

PC HARDWARE NETWORKING	CSE-PCHN	2018-2019	1	40Hrs	54	54
ANGULAR.JS	CSE-AJS	2018-2019	1	30Hrs	50	50
WEB APPLICATION DEVELOPMENT USING PHP & XML	IT-PHP-XML	2018-2019	1	30Hrs	54	54
TECHNICAL TRAINING HTML	IT-HTML	2018-2019	1	30Hrs	58	58
COMPUTER AIDED DESIGN CREO	AERO-CREO	2018-2019	1	30Hrs	18	18
COMMUNICATION SKILLS	HNS-CS	2018-2019	1	36Hrs	25	25
Year 4						
Name of Add on /Certificate programs offered	Course Code (if any)	Year of offering	No. of times offered during the same year	Duration of course	Number of students enrolled in the year	Number of Students completing the course in the year
E-TABS	CE-ET	2017-2018	1	30Hrs	35	35
GEO5	CE-G5	2017-2018	1	30Hrs	65	65
STAAD-PRO	CE-SP	2017-2018	1	30Hrs	65	65
INDUSTRIAL MANAGEMENT	EEE-IM	2017-2018	1	30Hrs	30	30
ELECTRICAL INSTALLATION STANDARDS	EEE-EIS	2017-2018	1	40Hrs	39	39
AUTO CAD	MECH-AUTOCAD	2017-2018	1	30Hrs	78	78
CATIA	MECH-CATIA	2017-2018	1	30Hrs	70	70
ANSYS	MECH-ANSYS	2017-2018	1	30Hrs	71	71
C PROGRAMMING	ECE-CP	2017-2018	1	30Hrs	50	50
JAVA CERTIFICATION PROGRAMME	ECE-JCP	2017-2018	1	40Hrs	50	50
ANDROID MOBILE APPLICATION TRAINING - C PROGRAMMING	CSE-AMA	2017-2018	1	30Hrs	49	49
JAVA CERTIFICATION PROGRAMME	IT-CP	2017-2018	1	30Hrs	51	51
COMPUTER AIDED DESIGN (CATIA)	IT-JCP	2017-2018	1	30Hrs	43	43
ULTRASONICS	AERO-CATIA	2017-2018	1	30Hrs	16	16
	HNS-US	2017-2018	1	36Hrs	25	25
Year 5						
Name of Add on /Certificate programs offered	Course Code (if any)	Year of offering	No. of times offered during the same year	Duration of course	Number of students enrolled in the year	Number of Students completing the course in the year
E-TABS	CE-ET	2016-2017	1	30Hrs	67	67
GEO5	CE-G5	2016-2017	1	30Hrs	54	54
STAAD-PRO	CE-SP	2016-2017	1	30Hrs	54	54

AUTO CAD	CE-AC	2016-2017	1	30Hrs	37	37
REVIT	CE-R	2016-2017	1	30Hrs	36	36
IMPORTANCY OF EARTHING	EEE-JOE	2016-2017	1	30Hrs	32	32
MULTISIM PROGRAM	EEE-MSP	2016-2017	1	30Hrs	39	39
AUTO CAD	MECH-AUTOCAD	2016-2017	1	30Hrs	70	70
CATIA	MECH-CATIA	2016-2017	1	30Hrs	71	71
ANSYS	MECH-ANSYS	2016-2017	1	30Hrs	88	88
MS OFFICE	ECE-MSO	2016-2017	1	30Hrs	51	51
CLOUD COMPUTING	ECE-CC	2016-2017	1	30Hrs	51	51
PC HARDWARE NETWORKING	CSE-PCHN	2016-2017	1	30Hrs	54	54
TECHNICAL TRAINING MS-OFFICE	IT-MSO	2016-2017	1	30Hrs	25	25
CLOUD COMPUTING WITH HADOOP FRAMEWORK	IT-CC-HFW	2016-2017	1	30Hrs	36	36
MULTI ROTOR DRONE PILOT	AERO-MRDP	2016-2017	1	40Hrs	27	27
ATOMIC STRUCTURE	HNS-AS	2016-2017	1	40Hrs	25	25

PRINCIPAL
MAHAVEER
 INSTITUTE OF SCIENCE & TECHNOLOGY
 Bandlaguda, Hyd-500 005.

Vysapuri, Bandlaguda Post:Keshavnri,
Hyderabad-500 005, Telangana INDIA
Tel: 040-64596979,20020773, Fax: 040-24455003
E-mail: principal.mahaveer@gmail.com,
Website: www.mist.ac.in,

MAHAVEER
INSTITUTE OF SCIENCE & TECHNOLOGY
Approved by AICTE, Affiliated to JNTUH, Hyd.



PROPOSAL LETTER

Hyderabad,
27/07/2016.

To,
The principal,
MIST,
Hyderabad.

Sub: Proposal for two weeks workshop on AUTO CAD-Reg,

Dear Sir,

We are working as asst professor in the department of CIVIL ENGINEERING. Sir, we are going to conduct two weeks workshop on AUTO CAD. We require your approval to go head for further proceeding and hope to get an opportunity to serve you the best .

With thanks and Regards

From,
Civil Department
Mist,
Bandlaguda,
Hyderabad.



Thanks
PRINCIPAL
MAHAVEER
INSTITUTE OF SCIENCE & TECHNOLOGY
Bandlaguda, Hyd-500 005.



Date: 28.07.2016

CIRCULAR

Technical Training for II B. Tech students are starting from 1st Aug, 2016 onwards. All HODs and Placements coordinators have to manage the trainings and ensure 95% attendance all through the sessions.

All Mentors need to send the compiled feedback report to CH Swethamber, HOD at e3hod.civil@gmail.com daily.

Agenda: 1. Introduction to AUTOCAD.

Designed by: B RAMANA KUMAR



Ch. Swethamber
HOD

K. S. K.
PRINCIPAL
MAHAVEER
INSTITUTE OF SCIENCE & TECHNOLOGY
Vysapuri, Hyderabad-500



Auto CAD SYLLABUS

1: Getting Started with AutoCAD

- Opening and Creating Drawings
- Exploring the AutoCAD interface
- Zooming and Panning

2: Basic Drawing & Editing Commands

- Using the Mouse, Keyboard, and Enter Key to work quickly and efficiently in AutoCAD
- Lines
- Circles
- Rectangles

3: Projects - Creating a Simple Drawing

- Creating Simple Drawings
- Using Object Snap Tracking to extrapolate a projected top view
- Using Modify tools to arrange an office layout

4: Drawing Precision in AutoCAD

- Polar and Ortho Tracking
- Entering Coordinates and Angles
- Object Snaps and Tracking

5: Making Changes in Your Drawing

- Move
- Copy
- Rotate
- Mirror
- Scale
- Using the reference option with the Scale Tool

7: Organizing Your Drawing with Layers

- Layer States
- Properties by Layer
- Layer Tools

8: Advanced Object Types



Mahaveer
PRINCIPAL
MAHAVEER
INSTITUTE OF SCIENCE & TECHNOLOGY
HYDERABAD

- Polylines
- Arcs
- Polygons
- Ellipses

9: Advanced Editing Commands

- Trim and Extend
- Fillet and Chamfer
- Polyline Edit and Spline
- Offset and Explode
- Join

10: Inserting Blocks

- The Insert Block Command
- Inserting Blocks with Tool Palettes
- Dynamic Blocs
- Migrating Blocks and other Elements between Drawings with Design Center

11: Text

- The Multiline Text Tool
- The Single Line Text Tool
- Editing Text
- Text in Model Space vs. Paper Space
- The Multileader Tool

12: Hatching

- The Hatch Command
- The Hatch Editor Ribbon Tab
- Saving and Applying Hatches with Tool Palettes

13: Adding Dimensions

- Using Dimensioning Tools
- Dimensioning in a Layout Tab vs. the Model Tab
- Using Dimension Styles
- Editing Dimensions

14. Projects - Annotating Your Drawing

- Dimensioning a Mechanical Drawing

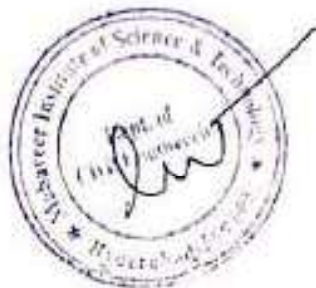

Kishu
PRINCIPAL
MANAGER
 INSTITUTE OF SCIENCE & TECHNOLOGY
 Bandlaguda, Hyd-500 005.



Department of Civil Engineering
Auto CAD Technical Training student attendance list 2016-17

S.No	Hall Ticket No	Name of the Candidate	Year
1	15E31A010 1	A DIVISHA	II
2	15E31A010 3	BAGUROTHU SAIJWALA	II
3	15E31A010 8	CHANDA VENKATESH	II
4	15E31A010 9	DHADI VIJAY	II
5	15E31A011 1	ELISHETTY TEJASWINI	II
6	15E31A011 2	ERUKULLA SRIKANTH	II
7	15E31A011 3	G ABHILASH	II
8	15E31A011 5	GOPI PRANAY	II
9	15E31A011 7	LOKASANI SURENDER REDDY	II
10	15E31A011 8	M AVINASH	II
11	15E31A011 9	MADIRE NARESH	II
12	15E31A012 0	MD ABDUL MUNAM	II
13	15E31A012 1	MD SALMAN CHOUDHARY	II
14	15E31A012 2	MOHAMMED ETHESHAM	II
15	15E31A012	MOHD AHMED	II



K. Sankar
PRINCIPAL
MAHAVEER
INSTITUTE OF SCIENCE & TECHNOLOGY
Bandlaguda, Hyderabad-500 005.

	3		II
16	15E31A012 4	MUBARAK AL DAYANI	II
17	15E31A012 5	NENAVATH SANTHOSH	II
18	15E31A013 0	PITTALA RAJESH KUMAR	II
19	15E31A013 1	SABIR ALIE	II
20	15E31A013 3	SHEELAM PRAMOD KUMAR	II
21	15E31A013 4	SIDDINI CHANDU	II
22	15E31A013 6	SRIRANGAM CHARISHIMA	II
23	15E31A014 0	VADLA SHRAVAN KUMAR	II
24	15E31A014 1	Y SAIKIRAN	II
25	15E31A014 2	ZEESHAN ASHRAF	II
26	15E31A014 3	M A KHADER ANSARI	II
27	15E31A014 4	PALOJU SRICHAITHANYA	II
28	15E31A014 5	GOLLA VISHNU YADAV	II
29	16E35A010 1	GADDAM CHARAN	II
30	16E35A010 2	GUNDALA MANISH	II
31	16E35A010 3	JANAPATI RAVI	II
32	16E35A010 4	M PRASHANTH	II
33	16E35A010 5	M. RANJITHA	II
34	16E35A010 6	M SHARADA	II
35	16E35A010 7	P.PRAVALIKA	II
36	16E35A010 8	POGAKU KEERTHI MADIURI	II
37	16E35A010 9	REDAPAKA MAHESHWARI	II



Kanish
PRINCIPAL
MAHAVEER
 INSTITUTE OF SCIENCE & TECHNOLOGY
 Bandlaguda, Hyd-500 605.

Vysapuri, Bandlaguda Post, Keshavnagar,
Hyderabad-500 005, Telangana INDIA
Tel: 040-64596979, 20020773, Fax: 040-24455003
E-mail: principal.mahaveer@gmail.com,
Website: www.mist.ac.in,

MAHAVEER

INSTITUTE OF SCIENCE & TECHNOLOGY
Approved by AICTE, Affiliated to JNTUH, Hyd.



Technical Training Exam on Auto CAD Software
(A.Y-2016-17)

2x10=20 Marks

Answer All the Questions

1. Draw the given 2D model by using AutoCad



K. Suresh
PRINCIPAL
MAHAVEER
INSTITUTE OF SCIENCE & TECHNOLOGY
Bandlaguda, Hyderabad

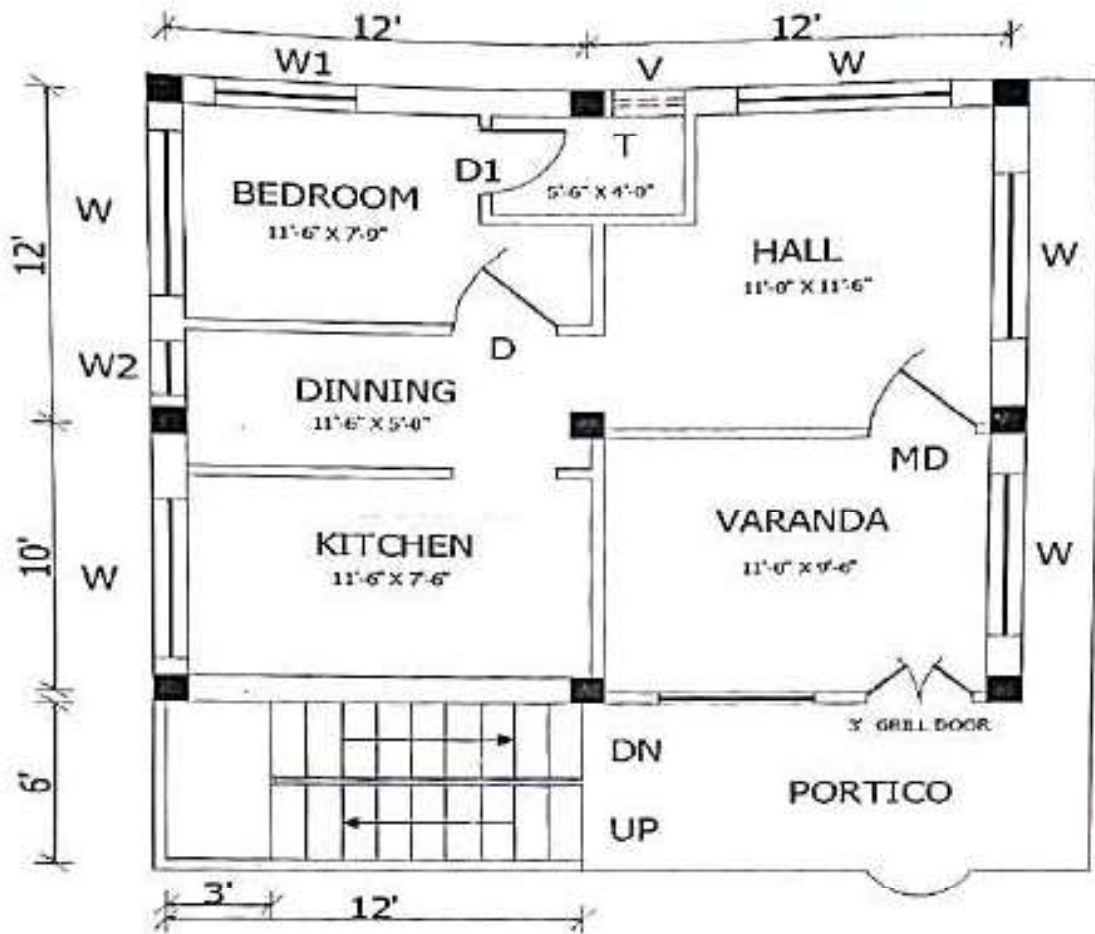

2. (a) Draw the following using any CAD software and add dimensioning.
- (b) List the commands in sequence and also write the procedure
- (c) Add title box containing Student PIN, name and college name



Handwritten signature
PRINCIPAL
MAHAVEER
 INSTITUTE OF SCIENCE & TECHNOLOGY
 GURGAON, HARYANA

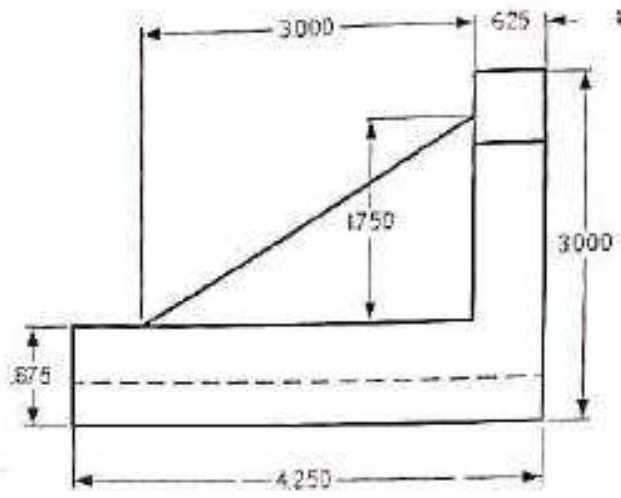
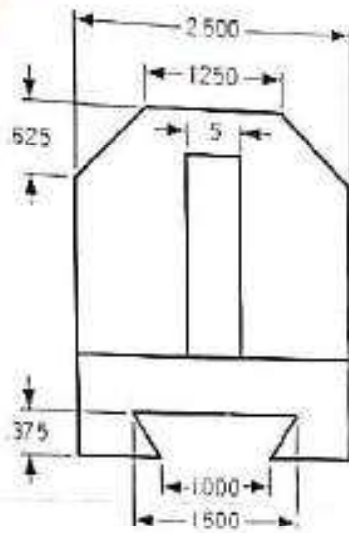

Mahaveer
PRINCIPAL
MAHAVEER
 INSTITUTE OF SCIENCE & TECHNOLOGY
 Bandlaguda, Hyderabad

Department of Civil Engineering
Auto CAD Technical Training student attendance list 2016-17

S.No	Hall Ticket No	Name of the Candidate	Year	Marks	Pass/Fail
1	15E31A010 1	A DIVISHA	II	15	Pass
2	15E31A010 3	BAGUROTHU SAIJWALA	II	16	Pass
3	15E31A010 8	CHANDA VENKATESH	II	15	Pass
4	15E31A010 9	DHADI VIJAY	II	15	Pass
5	15E31A011 1	ELISHETTY TEJASWINI	II	17	Pass
6	15E31A011 2	ERUKULLA SRIKANTH	II	16	Pass
7	15E31A011 3	G ABHILASH	II	16	Pass
8	15E31A011 5	GOPI PRANAY	II	17	Pass
9	15E31A011 7	LOKASANI SURENDER REDDY	II	15	Pass
10	15E31A011 8	M AVINASH	II	15	Pass
11	15E31A011 9	MADIRE NARESH	II	16	Pass
12	15E31A012 0	MD ABDUL MUNAM	II	15	Pass
13	15E31A012 1	MD SALMAN CHOUDHARY	II	18	Pass
14	15E31A012 2	MOHAMMED ETHESHAM	II	18	Pass
15	15E31A012 3	MOHD AHMED	II	13	Pass
16	15E31A012 4	MUBARAK AL DAYANI	II	14	Pass
17	15E31A012 5	NENAVATH SANTHOSH	II	15	Pass
18	15E31A013	PITTALA RAJESH KUMAR	II	15	Pass



K. Mahaveer
PRINCIPAL
MAHAVEER
 INSTITUTE OF SCIENCE & TECHNOLOGY
 Bandlaguda, Hyderabad

	0				
19	15E31A013 1	SABIR ALIE	II	16	Pass
20	15E31A013 3	SHEELAM PRAMOD KUMAR	II	16	Pass
21	15E31A013 4	SIDDINI CHANDU	II	15	Pass
22	15E31A013 6	SRIRANGAM CHARISHIMA	II	16	Pass
23	15E31A014 0	VADLA SHRAVAN KUMAR	II	17	Pass
24	15E31A014 1	Y SAIKIRAN	II	15	Pass
25	15E31A014 2	ZEESHAN ASHRAF	II	15	Pass
26	15E31A014 3	M A KHADER ANSARI	II	15	Pass
27	15E31A014 4	PALOJU SRICHAITHANYA	II	16	Pass
28	15E31A014 5	GOLLA VISHNU YADAV	II	15	Pass
29	16E35A010 1	GADDAM CHARAN	II	16	Pass
30	16E35A010 2	GUNDALA MANISH	II	16	Pass
31	16E35A010 3	JANAPATI RAVI	II	17	Pass
32	16E35A010 4	M PRASHANTH	II	18	Pass
33	16E35A010 5	M. RANJITHA	II	18	Pass
34	16E35A010 6	M SHARADA	II	16	Pass
35	16E35A010 7	P.PRAVALIKA	II	17	Pass
36	16E35A010 8	POGAKU KEERTHI MADIURI	II	18	Pass
37	16E35A010 9	REDAPAKA MAHESHWARI	II	17	Pass



Mahaveer
PRINCIPAL
MAHAVEER
 INSTITUTE OF SCIENCE & TECHNOLOGY
 Bandlaguda, Hyd-500 005.

Vysapuri, Bandlaguda Post Keshavnagar,
Hyderabad-500 606, Telangana INDIA
Tel: 040-64596979, 20028773, Fax: 040-24435003
E-mail: principal.mahaveer@gmail.com,
Website: www.mist.ac.in

MAHAVEER
INSTITUTE OF SCIENCE & TECHNOLOGY
Approved by AICTE, Affiliated to JNTUH, Hyd.



Auto CAD COURSE
Summary

Department of Civil Engineering

- Use AutoCAD for daily working process.
- Navigate throughout AutoCAD using major navigating tools.
- Understand the concept and techniques to draw.
- Create multiple designs using several of tools.
- Create layers to control the objects' visibility.
- Explain drawing using annotations.
- Plot or print the drawing by scale.



K. Mahaveer
PRINCIPAL
MAHAVEER
INSTITUTE OF SCIENCE & TECHNOLOGY
Bandlaguda, Hyd-500 606.

Vysapuri, Bandlaguda Post:Keshavnagar,
Hyderabad-500 005, Telangana INDIA
Tel: 040-64596979,20020773, Fax: 040-24455003
E-mail: principal.mahaveer@gmail.com,
Website: www.mist.ac.in,

MAHAVEER
INSTITUTE OF SCIENCE & TECHNOLOGY
Approved by AICTE, Affiliated to JNTUH,Hyd.



CERTIFICATE OF COURSE COMPLETION

This certificate is presented to _____ of MIST, who has successfully completed technical training course on “Auto CAD” held from _____ to _____ and found the student performance to be excellent.



ESTD : 2001

K. S. S.
PRINCIPAL
MAHAVEER
INSTITUTE OF SCIENCE & TECHNOLOGY
Keshavnagar, Hyderabad-005.

Ch. Swethamber

HOD

Civil Department



Vysapuri, Bandlaguda Post, Keshavnagar,
Hyderabad-500 005, Telangana, INDIA
Tel: 040-64596379, 20020773, Fax: 040-24455003
E-mail: principal.mahaveer@gmail.com
Website: www.mist.ac.in

MAHAVEER

Approved by AICTE, Affiliated to JNTU, Hyderabad



DEPARTMENT OF CIVIL ENGINEERING

PROPOSAL LETTER

Hyderabad,
16/04/2016.

To,
The principal,
MIST,
Hyderabad.

Sub: Proposal for three weeks workshop on REVIT-Reg.

Dear Sir,

We are working as asst professor in the department of CIVIL ENGINEERING. Sir, we are going to conduct three weeks workshop on REVIT. We require your approval to go head for further proceeding and hope to get an opportunity to serve you the best.

With thanks and Regards



K. Srinivas
PRINCIPAL
MAHAVEER
INSTITUTE OF SCIENCE & TECHNOLOGY
Bandlaguda, Hyderabad-500 005

From,
Civil Department,
Mist,
Bandlaguda,

Vysapuri, Bandlaguda Post:Keshavnagar,
Hyderabad-500 005, Telangana INDIA
Tel: 040-64596979,20020773, Fax: 040-24455003
E-mail: principal.mahaveer@gmail.com
Website: www.mist.ac.in

MAHAVEER

INSTITUTE OF SCIENCE & TECHNOLOGY
Approved by AICTE, Affiliated to JNTUH,Hyd.



Date: 02.05.2016

CIRCULAR

Technical Training for II B. Tech students are starting from 2nd MAY, 2016 onwards. All HODs and Placements coordinators have to manage the trainings and ensure 95% attendance all through the sessions.

All Mentors need to send the compiled feedback report to CH.Swethamber, HOD at c3hod.civil@gmail.com daily.

Agenda: 1. Introduction to Revit.

Designed by :M.SARITHA

K.MAHESH

CH.SWETHAMBER

HOD



K.Mahesh

PRINCIPAL
MAHAVEER
INSTITUTE OF SCIENCE & TECHNOLOGY
Bandlaguda, Hyd-500 005.



REVIT SYLLABUS

DAY	SUBJECT	KEYWORD
Day-1	Introduction to BIM & Autodesk Revit	1. Introduction to BIM & Revit 2. Version of Revit 3. Starting Projects 4. User Interface
Day-2	Setting up Levels & wall, adding components	1. Making Levels 2. wall setup 3. 3D Components (Interior & Exterior)
Day-3	Working with basic tools	1. Basic modify tools Moving, Copying, Mirror, Trim 2. Working with addition/modify tools
Day-4	Modelling Floors, Roofs, Stairs, Railings, Ceiling	1. Making floor & roof 2. Creating & Modifying stairs 3. Creating Railing 4. Adding Ceiling
Day-5	Working with Grid & Column	1. Creating & modify the Grid 2. Adding Column
Day-6	Working with Materials	1. Setting of Materials 2. Apply Texture & Colour
Day-7	Creating Construction Documents	1. Making Sheetfile 2. Adding planes, elevations, section, 3D views
Day-8	Making Walkthrough	1. Use of camera 2. Making Animation
Day-9	Introduction to Revit Structure	1. Starting Projects 2. Overview of the interface
Day-10	Starting structural project & basic modify tools	1. Setting of Levels & Grids 2. working with basic tools (Move, Rotate, Copy, Mirror)
Day-11	Working with views	1. Setting the view display 2. Creating Elevation & section
Day-12	Structural Grids & Columns	1. Adding Grids 2. Placing Columns
Day-13	Foundation	1. Modelling walls 2. Adding wall footing 3. Adding Isolated footing
Day-14	Adding Structural Slab	1. Creating & modify Slab
Day-15	Structural Reinforcement	1. Structural Reinforcement 2. Adding Rebar 3. Modify Rebar 4. Reinforcing Slabs

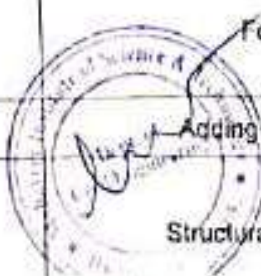

K. Srinivas
PRINCIPAL
MAHAVEER
INSTITUTE OF SCIENCE & TECHNOLOGY
BANDLAGUDA, HYD. 500 005

Vysapuri, Bandlaguda Post, Koshavari,
Hyderabad-509 005, Telangana INDIA
Tel: 040-64396379, 20020773, Fax: 040-24455003
E-mail: principal.mahaveer@gmail.com,
Website: www.mist.ac.in,

MAHAVEER

INSTITUTE OF SCIENCE & TECHNOLOGY

Approved by AICTE, Affiliated to JNTUH, Hyd



Department of Civil Engineering Revit Technical Training student attendance list 2016-2017

SL.NO.	ROLL NO.	NAME OF THE STUDENT	YEAR
1	15E31A0101	A DIVISHA	II
2	15E31A0103	BAGUROTHU SAIUJWALA	II
3	15E31A0108	CHANDA VENKATESH	II
4	15E31A0109	DHADI VIJAY	II
5	15E31A0111	ELISHETTY TEJASWINI	II
6	15E31A0112	ERUKULLA SRIKANTH	II
7	15E31A0113	G ABHILASH	II
8	15E31A0115	GOPI PRANAY	II
9	15E31A0117	LOKASANI SURENDER REDDY	II
10	15E31A0118	M AVINASH	II
11	15E31A0119	MADIRE NARESH	II
12	15E31A0120	MD ABDUL MUNAM	II
13	15E31A0121	MD SALMAN CHOUDHARY	II
14	15E31A0122	MOHAMMED ETHESHAM	II
15	15E31A0123	MOHD AHMED	II
16	15E31A0124	MUBARAK AL DAYANI	II
17	15E31A0125	NENAVATH SANTHOSH	II
18	15E31A0130	PITTALA RAJESH KUMAR	II
19	15E31A0131	SABIR ALI	II
20	15E31A0133	SHEELAM PRAMOD KUMAR	II

21	15E31A0134	SIDDINI CHANDU	
22	15E31A0136	SRIRANGAM CHARISHMA	
23	15E31A0140	VADLA SHRAVAN KUMAR	
24	15E31A0141	Y SAIKIRAN	
25	15E31A0142	ZEESHAN ASHRAF	
26	15E31A0143	M A KHADER ANSARI	
27	15E31A0144	PALOJU SRICHAITHANYA	
28	15E31A0145	GOLLA VISHNU YADAV	
29	16E35A0101	GADDAM CHARAN	
30	16E35A0102	GUNDALA MANISH	
31	16E35A0103	JANAPATI RAVI	
32	16E35A0104	M PRASHANTH	
33	16E35A0105	M. RANJITHA	
34	16E35A0107	P. PRAVALIKA	
35	16E35A0108	POGAKU KEERTHI MADHURI	
36	16E35A0109	REDAPAKA MAHESHWARI	



K. S. S.

PRINCIPAL
 MANAVEER
 INSTITUTE OF SCIENCE & TECHNOLOGY
 Bangalore, 560 075, INDIA

Vysapuri, Bandlaguda Post: Keshavpur,
Hyderabad-500 005, Telangana INDIA
Tel: 040-64586979, 20020773, Fax: 040-24455003
E-mail: principal.mahaveer@gmail.com,
Website: www.mist.ac.in,

MAHAVEER
INSTITUTE OF SCIENCE & TECHNOLOGY
Approved by AICTE, Affiliated to JNTUH, Hyd.



Technical Training Exam on Revit Software
(A.Y-2016-17)

2x10=20 Marks

Answer All the Questions

1. Draw the given 2D model into 3D model by using Revit

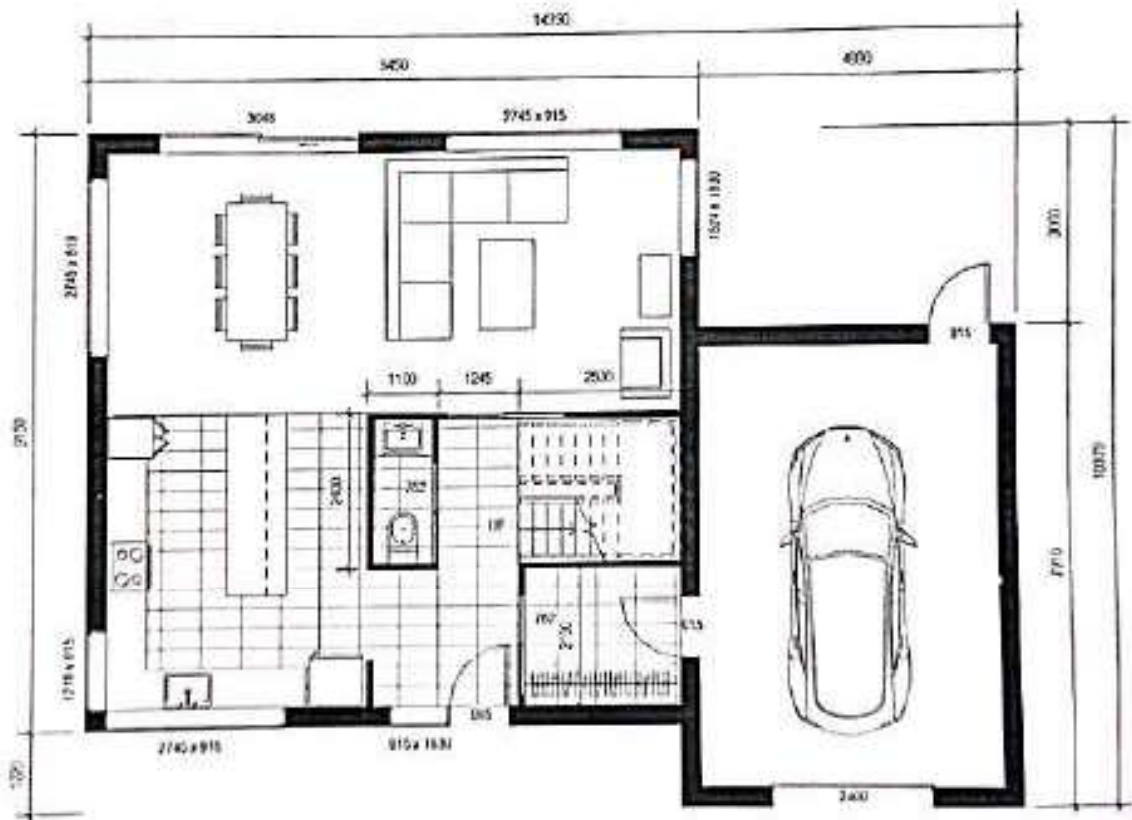

Mahaveer

PRINCIPAL
MAHAVEER
INSTITUTE OF SCIENCE & TECHNOLOGY
Bandlaguda, Hyd-500 005.

2. Draw the given centre to centre floor plan into 3D model by using Revit software.

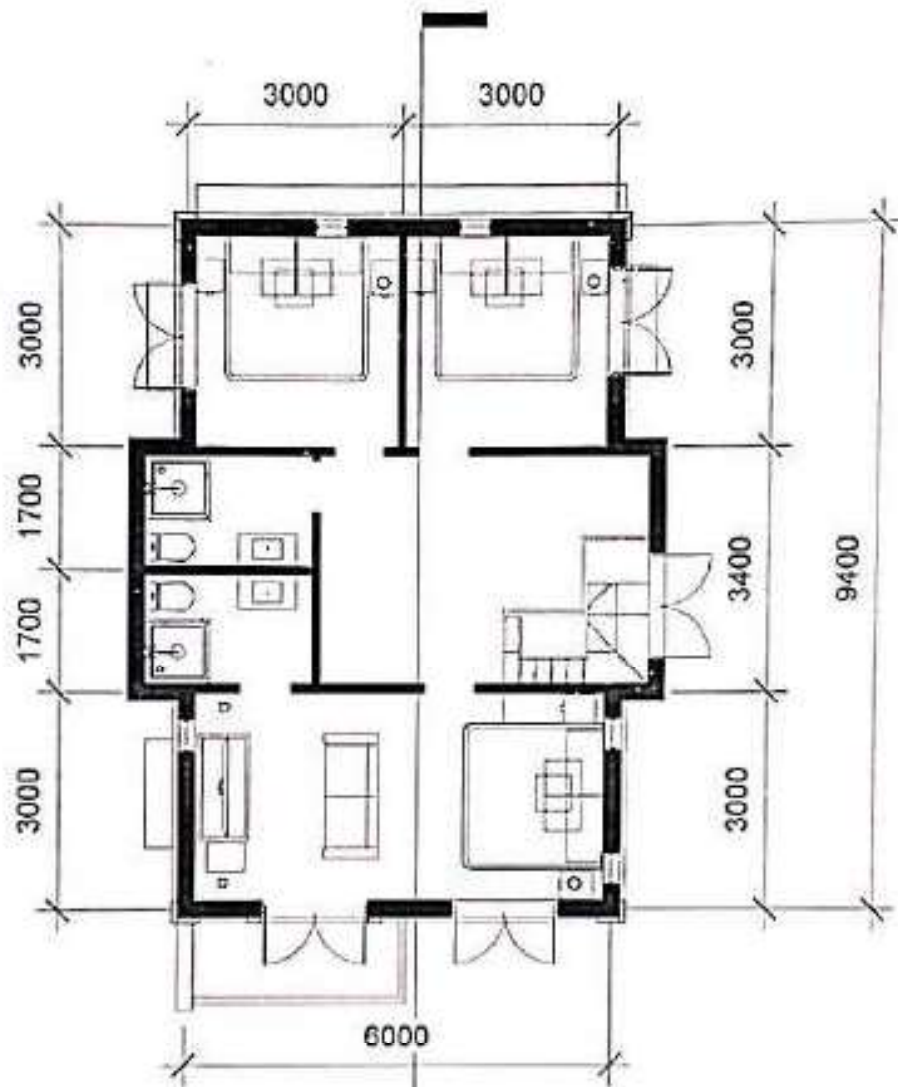

2
A104



K. Srinivas

PRINCIPAL
M. H. VEER
INSTITUTE OF SCIENCE & TECHNOLOGY
Bandlaguda, Hyd-503 005

Vysapuri, Bandlaguda Post:Keshavpur,
Hyderabad-500 005, Telangana INDIA.
Tel: 040-64596979,20820773,,Fax: 040-24455003
E-mail: principal.mahaveer@gmail.com
Website: www.mist.ac.in

MAHAVEER

INSTITUTE OF SCIENCE & TECHNOLOGY
Approved by AICTE, Affiliated to JNTU/Hydr.



Department of Civil Engineering
Revit Technical Training student Marks list 2016-17

Sl.NO	Roll No	Name of the student	YEAR	MARKS	PASS/FAIL
1	15E31A0101	A DIVISHA	II	16	PASS
2	15E31A0103	BAGUROTHU SAIJWALA	II	16	PASS
3	15E31A0108	CHANDA VENKATESH	II	12	PASS
4	15E31A0109	DHADI VIJAY	II	12	PASS
5	15E31A0111	ELISHETTY TEJASWINI	II	16	PASS
6	15E31A0112	ERUKULLA SRIKANTH	II	16	PASS
7	15E31A0113	G ABHILASH	II	16	PASS
8	15E31A0115	GOPI PRANAY	II	16	PASS
9	15E31A0117	LOKASANI SURENDER REDDY	II	16	PASS
10	15E31A0118	M AVINASH	II	16	PASS
11	15E31A0119	MADIRE NARESH	II	16	PASS
12	15E31A0120	MD ABDUL MUNAM	II	16	PASS
13	15E31A0121	MD SALMAN CHOUDHARY	II	16	PASS
14	15E31A0122	MOHAMMED ETHESHAM	II	16	PASS
15	15E31A0123	MOHD AHMED	II	16	PASS
16	15E31A0124	MUBARAK AL DAYANI	II	16	PASS
17	15E31A0125	NENAVATH SANTHOSH	II	16	PASS
18	15E31A0130	PITTALA RAJESH KUMAR	II	16	PASS
19	15E31A0131	SABIR ALI	II	15	PASS
20	15E31A0133	SHEELAM PRAMOD KUMAR	II	16	PASS
21	15E31A0134	SIDDINI CHANDU	II	16	PASS



K. Subudh
PRINCIPAL
MAHAVEER
INSTITUTE OF SCIENCE & TECHNOLOGY
Bandlaguda, Hyd-500 005.

22	15E31A0136	SRIRANGAM CHARISHMA	II	15	PASS
23	15E31A0140	VADLA SHRAVAN KUMAR	II	16	PASS
24	15E31A0141	Y SAIKIRAN	II	14	PASS
25	15E31A0142	ZEESHAN ASHRAF	II	15	PASS
26	15E31A0143	M A KHADER ANSARI	II	15	PASS
27	15E31A0144	PALOJU SRICHAITHANYA	II	16	PASS
28	15E31A0145	GOLLA VISHNU YADAV	II	14	PASS
29	16E35A0101	GADDAM CHARAN	II	16	PASS
30	16E35A0102	GUNDALA MANISH	II	15	PASS
31	16E35A0103	JANAPATI RAVI	II	14	PASS
32	16E35A0104	M PRASHANTH	II	18	PASS
33	16E35A0105	M. RANJITHA	II	15	PASS
34	16E35A0107	P.PRAVALIKA	II	16	PASS
35	16E35A0108	POGAKU KEERTHI MADHURI	II	15	PASS
36	16E35A0109	REDAPAKA MAHESHWARI	II	16	PASS



K. Srinivas
PRINCIPAL
MAHAVEER
 INSTITUTE OF SCIENCE & TECHNOLOGY
 Bandlaguda, Hyd-500 005.

Vysapuri, Bandlaguda Post: Keshavnagar,
Hyderabad-500 005, Telangana INDIA
Tel: 040-84696979, 20020773, Fax: 040-24465003
E-mail: principal.mahaveer@gmail.com,
Website: www.mst.ac.in,

MAHAVEER

INSTITUTE OF SCIENCE & TECHNOLOGY
Approved by AICTE, Affiliated to JNTUH, Hyd.



Revit COURSE
Summery

Department of Civil Engineering

- Use Revit for daily working process.
- Navigate throughout Revit using major navigating tools.
- Understand the concept and techniques to draw.
- Create multiple designs using several of tools.
- Create layers to control the objects' visibility.
- Explain drawing using annotations.
- Plot or print the drawing by scale.
- To use constraint for certain design.



K. Srinivas
PRINCIPAL
MAHAVEER
INSTITUTE OF
BANDLAGUDA POST, KESHAVNAGAR,
HYDERABAD-500 005, TELANGANA INDIA.

Vysapturi, Bandlaguda Post:Keshavgiri,
Hyderabad-500 006, Telangana INDIA
Tel: 040-64596979,20626773, Fax: 040-24455003
E-mail: principal.mahaveer@gmail.com
Website: www.mist.ac.in

MAHAVEER

INSTITUTE OF SCIENCE & TECHNOLOGY
Approved by AICTE. Affiliated to JNTUH,Hyd.



CERTIFICATE OF COURSE COMPLETION

This certificate is presented to _____ of MIST,who has successfully completed technical training course on "Revit" held from _____ to _____ and found the student performance to be excellent.



ESTD : 2001

CH.SWETHAMBER
HOD

Civil Department



K. S. S. S.
PRINCIPAL
MAHAVEER

INSTITUTE OF SCIENCE & TECHNOLOGY
BANDLAGUDA POST, VYSAPURI, HYDRABAD-500006, TELANGANA, INDIA

Vysapuri, Bandlaguda Post:Keshavgirl,
Hyderabad-500 005, Telangana INDIA
Tel: 040-64596379,20020773, Fax: 040-24455003
E-mail: principal.mahaveer@gmail.com,
Website: www.mist.ac.in,

MAHAVEER

INSTITUTE OF SCIENCE & TECHNOLOGY
Approved by AICTE, Affiliated to JNTUH,Hyd.



DEPARTMENT OF CIVIL ENGINEERING
PROPOSAL LETTER

Hyderabad,

10/08/2016.

To,
The principal,
MIST,
Hyderabad.

Sub: Proposal for three weeks workshop on ETABS-Reg.

Dear Sir,

We are working as asst professor in the department of CIVIL ENGINEERING. Sir, we are going to conduct three weeks workshop on ETABS. We require your approval to go head for further proceeding and hope to get an opportunity to serve you the best .

With thanks and Regards



Kishu
PRINCIPAL
MAHAVEER
INSTITUTE OF SCIENCE & TECHNOLOGY
Bandlaguda, Hyderabad

From,
Civil Department
Mist,
Bandlaguda,

Vysapuri, Bandlaguda Post:Keshavgiri,
Hyderabad-500 005, Telangana INDIA
Tel: 040-64596979,20020773..Fax: 040-24455003
E-mail: principal.mahaveer@gmail.com,
Website: www.mist.ac.in,

MAHAVEER
INSTITUTE OF SCIENCE & TECHNOLOGY
Approved by AICTE, Affiliated to JNTUH,Hyd.



DEPARTMENT OF CIVIL ENGINEERING

Hyderabad.

Date: 12.08.2016

CIRCULAR

Technical Training for III B. Tech students are starting from 12 -08- 2016 onwards. All HODs and Placements coordinators have to manage the trainings and ensure 95% attendance all through the sessions.

All Mentors need to send the compiled feedback report to Ch.Swethamber, HOD at c3hod.civil@gmail.com daily.

Agenda: 1. Introduction to ETABS.

CH.SWETHAMBER

HOD



Design by : BRAMANAKUMAR

M.SARITHA

K. Subh
PRINCIPAL
MAHAVEER
INSTITUTE OF SCIENCE & TECHNOLOGY
Bandlaguda, Hyderabad



DEPARTMENT OF CIVIL ENGINEERING

ETABS SYLLABUS

- 1: The knowledge about specialized software such as ETABS, SAFE to model and analyze for buildings.
- 2: Be able to model, analyze, and solve structural models on Specialized software and access analysis results such as force, Displacement and another parameter for structural design.
- 3: Be able to communicate and work in the group flexibly and Efficiently.
- 4: Explaining concepts, terminology and rules used in ETABS, SAFE software.
- 5: Modeling and analyzing type of simple and complex structural Systems.
- 6: Analyzing and determining the values of internal forces, Displacements and other parameters for structural design.
- 7: Working in the group to solve the problems relates to using Software ETABS, SAFE.
- 8: Choosing appreciable communication skills such as speech, Text, images, graphics, when expressing personal views.



K. Srinivas
PRINCIPAL
MAHAVEER
INSTITUTE OF SCIENCE & TECHNOLOGY
HYD.

Vysapuri, Bandlaguda Post:Keshavgi,
Hyderabad-500 005, Telangana INDIA
Tel: 040-64596979,26020773, Fax: 040-24455003
E-mail: principal.mahaveer@gmail.com
Website: www.mist.ac.in

MAHAVEER
INSTITUTE OF SCIENCE & TECHNOLOGY
Approved by AICTE, Affiliated to JNTU-Hyd.



DEPARTMENT OF CIVIL ENGINEERING
ETABS Technical Training student list 2016-17

SL.NO.	Hall Ticket No	Name of the Candidate	YEAR
1	14E31A0101	A SRIKANTH	III
2	14E31A0102	ABDUR RAHEEM MUNAWWAR	III
3	14E31A0103	AMBATI NEELIMA	III
4	14E31A0104	ANKITH KUMAR TIWARI	III
5	14E31A0105	AREF ABDUR RAHMAN AL KASERI	III
6	14E31A0106	AVULA AJAYA LAKSHMI	III
7	14E31A0107	BATHARAJU ARUN KUMAR	III
8	14E31A0108	BATTHINI VINAY	III
9	14E31A0109	BEJJURI PRASHANTH	III
10	14E31A0111	BOINIPELLI SHRUTHI	III
11	14E31A0112	BUDUGULA KIRAN KUMAR	III
12	14E31A0113	CHITIKESHI OMPRAKASH	III
13	14E31A0114	EPPA OMPRAKASH	III
14	14E31A0115	FAIZAN BAIG	III
15	14E31A0116	GADDAVARI SHIVA KRISHNA	III
16	14E31A0117	GANDLA SUHRUDH	III
17	14E31A0118	GORLA SHRAVANI	III
18	14E31A0119	GOTTE TEJASWEI	III
19	14E31A0120	ISLAVATH PAVANKUMAR	III
20	14E31A0121	JADHAV SAI KRISHNA	III
21	14E31A0122	KONUGANTI NIKHIL REDDY	III



Konuganti
PRINCIPAL,
MAHAVEER

DATE:

Vysapuri, Bandlaguda Post:Keshavnagar,
Hyderabad-500 005, Telangana INDIA
Tel: 040-64596979,20020773, Fax: 040-24455003
E-mail: principal.mahaveer@gmail.com,
Website: www.mist.ac.in,

MAHAVEER

INSTITUTE OF SCIENCE & TECHNOLOGY
Approved by AICTE, Affiliated to JNTUH,Hyd.



22	14E31A0123	MAJARI CHANDRA SHEKHAR	III
23	14E31A0124	MASARATH JAHAN	III
24	14E31A0125	MEKAPOTHULA SANDEEP	III
25	14E31A0126	MIR SIDDIQ MUQTADIR ALI HASHMI	III
26	14E31A0127	MOGILI LIKHITHA	III
27	14E31A0128	MOGULAM ROHITH	III
28	14E31A0129	MOHAMMED AIRAJ MOHIUDDIN	III
29	14E31A0130	MOHAMMED ASIM SULEMAN	III
30	14E31A0131	MOHAMMED JAWAD UDDIN	III
31	14E31A0133	MOHD ABDUL ALI FUZAIL	III
32	14E31A0134	MOHD ABDUL RAOOF	III
33	14E31A0136	MOHD IBRAHIMA FARUQE	III
34	14E31A0137	MOHD MOHIUDDIN FAIZ	III
35	14E31A0139	NAARSING AISHWARYA	III
36	14E31A0140	NIMMALA THIRUPATHI	III
37	14E31A0141	PALAM SRIKANTH REDDY	III
38	14E31A0142	PERAPOGU SHASHI KIRAN	III
39	14E31A0144	RAVINTHALA NARENDRA BABU	III
40	14E31A0145	SAYYAD SOHEL	III
41	14E31A0147	SHAIK RAHIL FARAZ	III
42	14E31A0148	SILUVERI MADHUKAR	III
43	14E31A0149	SOMA SRILATHA	III
44	14E31A0150	SYED ISMAIL	III
45	14E31A0151	SYED KALEEM ULLAH QUADRI	III
46	14E31A0152	SYED MOHAMMED FIRDOUSE	III
47	14E31A0153	SYED MUSTAFA ALI	III

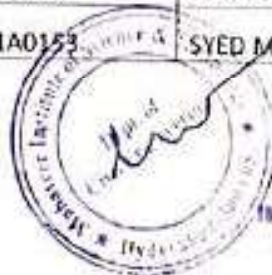

Kshirip
PRINCIPAL
MAHAVEER

Vysepuri, Bandlaguda Post, Keshavnagar,
Hyderabad-500 005, Telangana INDIA
Tel: 040-64556379, 20020773, Fax: 040-24455003
E-mail: principal.mahaveer@gmail.com
Website: www.mist.ac.in

MAHAVEER

INSTITUTE OF SCIENCE & TECHNOLOGY
Approved by AICTE, Affiliated to JNTUH, Hyd



48	14E31A0154	SYED NUMAN	III
49	14E31A0155	SYED SAAD SHAREEF	III
50	14E31A0156	TINGILKAR VISHAL	III
51	14E31A0157	VAISHNAVI UPADHYAY	III
52	14E31A0158	VANAPARTHI SANTHOSH VARMA	III
53	14E31A0159	VEMULA AVINASH	III
54	13E31A0102	ABDUL RAHMAN BIN HASSAN AL YAFAI	III
55	15E35A0101	ALTAF AHMED	III
56	15E35A0102	B SAI KRISHNA	III
57	15E35A0103	BORRA RAGHU RAM	III
58	15E35A0104	GANGULA RATHNA KUMAR	III
59	15E35A0105	KASTHOORI VENKATAKRISHNA	III
60	15E35A0106	MD JUNED	III
61	15E35A0107	METHUKU SAGAR REDDY	III
62	15E35A0108	MOHAMMED NADEEMUDDIN	III
63	15E35A0109	NALLA SHESHU VARDHAN REDDY	III
64	15E35A0110	NALLAPU VEERA HANUMANATHA RAO	III
65	15E35A0111	VANKUNAVATH PRAVEEN	III
66	15E35A0112	V KAVITHA	III
67	13E31A0105	AMBALA RAJKUMAR	III



K. Srinivas
PRINCIPAL
MAHAVEER
INSTITUTE OF SCIENCE & TECHNOLOGY
Bandlaguda, Hyd-500 005.

MAHAVEER INSTITUTE OF SCIENCE & TECHNOLOGY, HYDERABAD

CIVIL ENGINEERING STUDENTS ATTENDANCE

B.TECH III YEAR I SEM 2016-2017 BATCH (Date: 12-8-2016 to 24-08-2016)

S.No	Hall Ticket No	Name of the Candidate	1	2	3	4	5	6	7	8	9	10
1	14E31A0101	A SRIKANTH	P	P	P	P	P	A	P	P	P	P
2	14E31A0102	ABDUR RAHEEM MUNAWWAR	P	P	P	A	P	P	P	P	P	P
3	14E31A0103	AMBATI NEELIMA	A	P	P	P	P	P	P	P	P	P
4	14E31A0104	ANNITH KUMAR TIWARI	P	P	P	P	A	P	P	P	P	P
5	14E31A0105	AREF ABDUR RAHMAN AL KASERI	D	P	P	P	P	P	P	P	P	P
6	14E31A0106	AVULA AJAYA LAKSHMI	P	P	A	P	P	P	P	P	P	P
7	14E31A0107	BATHARAJU ARUN KUMAR	P	P	P	P	P	P	A	P	P	P
8	14E31A0108	BATTHINI VINAY	A	P	P	P	P	P	P	P	P	P
9	14E31A0109	BEJURI PRASHANTH	P	A	P	P	P	P	P	P	P	P
10	14E31A0111	BOINPELLI SHRUTHI	P	P	A	P	P	P	P	P	P	P
11	14E31A0112	BUDUGULA KIRAN KUMAR	P	P	P	P	P	P	P	P	P	A
12	14E31A0113	CHITIKESHI OMPRAKASH	A	P	P	A	P	P	P	P	P	P
13	14E31A0114	EPPA OMPRAKASH	P	P	P	P	P	P	P	P	P	P
14	14E31A0115	FAIZAN BAIG	P	A	P	P	P	A	P	P	P	P
15	14E31A0116	GADDAVARI SHIVA KRISHNA	P	P	P	P	A	P	P	P	P	P
16	14E31A0117	GANDLA SUHRUDH	P	P	P	P	P	A	P	P	P	P
17	14E31A0118	GORLA SHRAVANI	P	P	P	A	P	P	P	A	P	P
18	14E31A0119	GOTTE TEJASWEI	P	P	P	P	P	P	P	P	P	P
19	14E31A0120	ISLAVATH PAVANKUMAR	P	P	P	P	P	P	P	P	P	P
20	14E31A0121	JADHAV SAI KRISHNA	P	P	P	P	A	P	P	P	P	P
21	14E31A0122	KONUGANTI NIKHIL REDDY	P	P	P	P	P	P	P	P	P	P
22	14E31A0123	MAJJARI CHANDRA SHEKHAR	P	A	P	P	P	P	P	P	P	P
23	14E31A0124	MASARATH JAHAN	A	P	P	P	P	P	P	P	P	P
24	14E31A0125	MEKAPOTHUJA SANDEEP	P	P	P	P	P	P	P	P	P	P
25	14E31A0126	MIR SIDDIQ MUQTADIR ALI HASHIMI	P	P	P	P	P	P	P	P	P	P
26	14E31A0127	MOGILI LUKHITHA	P	P	P	P	P	P	P	P	P	P



14E31A0127
 MOGILI LUKHITHA
 12/08/2016



DEPARTMENT OF CIVIL ENGINEERING

Technical Training Exam on Etabs Software
(A.Y-2016-17)

2x10=20 Marks

Answer All the Questions

1) Design of composite steel using etabs

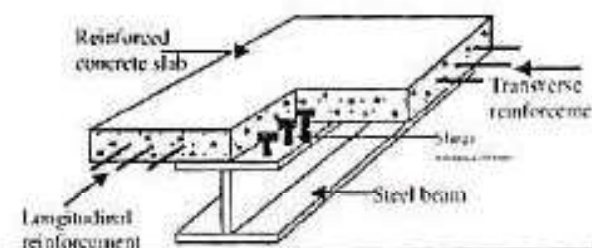

2) composite column using etabs

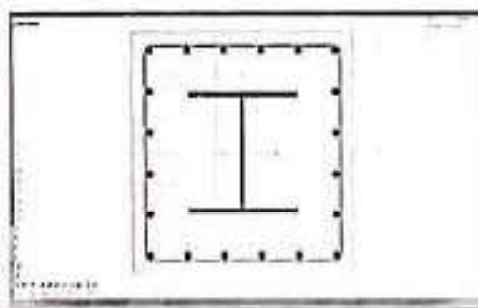

K. Mahaveer
PRINCIPAL
MAHAVEER
INSTITUTE OF SCIENCE & TECHNOLOGY
Bandlaguda, Hyderabad

Vysapuri, Bandlaguda Post: Keshavgi,
Hyderabad-500 005, Telangana INDIA
Tel: 040-6459979, 20020773, Fax: 040-24455003
E-mail: principal.mahaveer@gmail.com
Website: www.mist.ac.in

MAHAVEER

INSTITUTE OF SCIENCE & TECHNOLOGY
Approved by AICTE, Affiliated to JNTUH, Hyd.



DEPARTMENT OF CIVIL ENGINEERING ETABS Technical Training student Marks list 2016-17

Sl.NO	Hall Ticket No	Name of the Candidate	YEAR	MARKS	PASS/FAIL
1	14E31A0101	A SRIKANTH	III	16	PASS
2	14E31A0102	ABDUR RAHEEM MUNAWWAR	III	16	PASS
3	14E31A0103	AMBATI NEELIMA	III	12	PASS
4	14E31A0104	ANKITH KUMAR TIWARI	III	12	PASS
5	14E31A0105	AREF ABDUR RAHMAN AL KASERI	III	16	PASS
6	14E31A0106	AVULA AJAYA LAKSHMI	III	16	PASS
7	14E31A0107	BATHARAJU ARUN KUMAR	III	16	PASS
8	14E31A0108	BATTHINI VINAY	III	16	PASS
9	14E31A0109	BEJJURI PRASHANTH	III	16	PASS
10	14E31A0111	BOINPELLI SHRUTHI	III	16	PASS
11	14E31A0112	BUDUGULA KIRAN KUMAR	III	16	PASS
12	14E31A0113	CHITIKESHI OMPRAKASH	III	16	PASS
13	14E31A0114	EPPA OMPRAKASH	III	16	PASS
14	14E31A0115	FAIZAN BAIG	III	16	PASS
15	14E31A0116	GADDAVARI SHIVA KRISHNA	III	16	PASS
16	14E31A0117	GANDLA SUHRUDH	III	16	PASS
17	14E31A0118	GORLA SHRAVANI	III	16	PASS
18	14E31A0119	GOTTE TEJASWEI	III	16	PASS
19	14E31A0120	ISLAVATH PAVANKUMAR	III	15	PASS
20	14E31A0121	JADHAV SAI KRISHNA	III	16	PASS
21	14E31A0122	KONUGANTI NIKHIL REDDY	III	16	PASS
22	14E31A0123	MAJJARI CHANDRA SHEKHAR	III	15	PASS



K. Srinivas
PRINCIPAL
MAHAVEER
INSTITUTE OF SCIENCE & TECHNOLOGY
Bandlaguda, Hyderabad-500 005.

Vysapuri, Bandlaguda Post:Keshavgiri,
Hyderabad-500 005, Telangana INDIA
Tel: 040-64596979,20020773, Fax: 040-24455003
E-mail: principal.mahaveer@gmail.com,
Website: www.mist.ac.in,

MAHAVEER

INSTITUTE OF SCIENCE & TECHNOLOGY

Approved by AICTE, Affiliated to JNTUH,Hyd.



23	14E31A0124	MASARATH JAHAN	III	16	PASS
24	14E31A0125	MEKAPOTHULA SANDEEP	III	14	PASS
25	14E31A0126	MIR SIDDIQ MUQTADIR ALI HASHMI	III	15	PASS
26	14E31A0127	MOGILI LIKHITHA	III	15	PASS
27	14E31A0128	MOGULAM ROHITH	III	16	PASS
28	14E31A0129	MOHAMMED AIRAJ MOHIUDDIN	III	14	PASS
29	14E31A0130	MOHAMMED ASIM SULEMAN	III	16	PASS
30	14E31A0131	MOHAMMED JAWAD UDDIN	III	15	PASS
31	14E31A0133	MOHD ABDUL ALI FUZAIL	III	14	PASS
32	14E31A0134	MOHD ABDUL RAOOF	III	18	PASS
33	14E31A0136	MOHD IBRAHIMA FARUQE	III	15	PASS
34	14E31A0137	MOHD MOHIUDDIN FAIZ	III	16	PASS
35	14E31A0139	NAARSING AISHWARYA	III	15	PASS
36	14E31A0140	NIMMALA THIRUPATHI	III	16	PASS
37	14E31A0141	PALAM SRIKANTH REDDY	III	16	PASS
38	14E31A0142	PERAPOGU SHASHI KIRAN	III	15	PASS
39	14E31A0144	RAVINOTHALA NARENDRA BABU	III	16	PASS
40	14E31A0145	SAYYAD SOHEL	III	16	PASS
41	14E31A0147	SHAIK RAHIL FARAZ	III	15	PASS
42	14E31A0148	SILUVERI MADHUKAR	III	16	PASS
43	14E31A0149	SOMA SRILATHA	III	14	PASS
44	14E31A0150	SYED ISMAIL	III	15	PASS
45	14E31A0151	SYED KALEEM ULLAH QUADRI	III	15	PASS
46	14E31A0152	SYED MOHAMMED FIRDOUSE	III	16	PASS
47	14E31A0153	SYED MUSTAFA ALI	III	14	PASS
48	14E31A0154	SYED NUMAN	III	16	PASS



Kshalya
PRINCIPAL
MAHAVEER
INSTITUTE OF SCIENCE & TECHNOLOGY
Bandlaguda, Hyd-500 005.

Vysapuri, Bandlaguda Post:Keshavgiri,
Hyderabad-500 005, Telangana INDIA
Tel: 040-64596979,20020773, Fax: 040-24455003
E-mail: principal.mahaveer@gmail.com,
Website: www.mist.ac.in,

MAHAVEER
INSTITUTE OF SCIENCE & TECHNOLOGY
Approved by AICTE, Affiliated to JNTUH,Hyd.



49	14E31A0155	SYED SAAD SHAREEF	III	15	PASS
50	14E31A0156	TINGILKAR VISHAL	III	14	PASS
51	14E31A0157	VAISHNAVI UPADHYAY	III	18	PASS
52	14E31A0158	VANAPARTHI SANTHOSH VARMA	III	15	PASS
53	14E31A0159	VEMULA AVINASH	III	16	PASS
54	13E31A0102	ABDUL RAHMAN BIN HASSAN AL YAFAI	III	15	PASS
55	15E35A0101	ALTAF AHMED	III	15	PASS
56	15E35A0102	B SAI KRISHNA	III	18	PASS
57	15E35A0103	BORRA RAGHU RAM	III	15	PASS
58	15E35A0104	GANGULA RATHNA KUMAR	III	16	PASS
59	15E35A0105	KASTHOORI VENKATAKRISHNA	III	15	PASS
60	15E35A0106	MD JUNED	III	16	PASS
61	15E35A0107	METHUKU SAGAR REDDY	III	15	PASS
62	15E35A0108	MOHAMMED NADEEMUDDIN	III	16	PASS
63	15E35A0109	NALLA SHESHU VARDHAN REDDY	III	15	PASS
64	15E35A0110	NALLAPU VEERA HANUMANTHA RAO	III	14	PASS
65	15E35A0111	VANKUNAVATH PRAVEEN	III	18	PASS
66	15E35A0112	V KAVITHA	III	15	PASS
67	13E31A0105	AMBALA RAJKUMAR	III	16	PASS

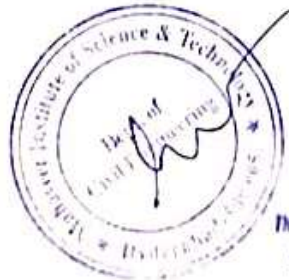

K. S. S. S.
PRINCIPAL
MAHAVEER
INSTITUTE OF SCIENCE & TECHNOLOGY
Bandlaguda, Hyd-500 005.

Vysapuri, Bandlaguda Post:Koshavpuri,
Hyderabad-500 005, Telangana INDIA
Tel: 040-64566373,20020773, Fax: 040-24456003
E-mail: principal.mahaveer@gmail.com,
Website: www.mist.ac.in,

MAHAVEER

INSTITUTE OF SCIENCE & TECHNOLOGY

Approved by AICTE, Affiliated to JNTUH,Hyd



Etabs course
Summary

Department of Civil Engineering

- Use ETABS for daily working process.
- Navigate throughout ETABS using major navigating tools.
- Understand the concept and techniques to draw.
- Create multiple designs using several of tools.
- Create layers to control the objects' visibility.
- Explain drawing using annotations.
- To use constraint for certain design.

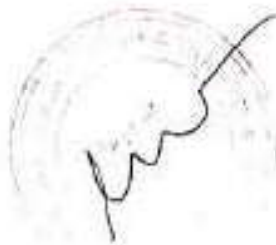

K. Srinivas
PRINCIPAL
MAHAVEER
INSTITUTE OF SCIENCE & TECHNOLOGY
Bandlaguda, Hyderabad-500 005.

Vysapuri, Bandlaguda Post:Keshavgi,
Hyderabad-500 005, Telangana INDIA
Tel: 040-64596979,20020773,, Fax: 040-24455003
E-mail: principal.mahaveer@gmail.com,
Website: www.mist.ac.in,

MAHAVEER

INSTITUTE OF SCIENCE & TECHNOLOGY
Approved by AICTE, Affiliated to JNTUH,Hyd.



CERTIFICATE OF COURSE COMPLETION

This certificate is presented to _____ of MIST,who
has successfully completed technical training course on “ETABS”
held from _____ to _____ and found the student
performance to be excellent.



ESTD : 2001

CH.SWETHAMBER

HOD

Civil Department

Kishu
PRINCIPAL
MAHAVEER
INSTITUTE OF SCIENCE & TECHNOLOGY
Bandlaguda, Hyderabad-500005.



Vysapuri, Bandlaguda Post:Keshavpuri,
Hyderabad-500 085, Telangana INDIA
Tel: 040-64596979,20020773, Fax: 040-24435003
E-mail: principal.mahaveer@gmail.com
Website: www.mist.ac.in

MAHAVEER
INSTITUTE OF SCIENCE & TECHNOLOGY
Approved by AICTE, Affiliated to JNTUHHyd.



PROPOSAL LETTER

Hyderabad,

20/07/2016.

To,
The principal,
MIST,
Hyderabad.

Sub: Proposal for three weeks workshop on GEO5-Reg.

Dear Sir,

We are working as asst professor in the department of CIVIL ENGINEERING. Sir, we are going to conduct three weeks workshop on GEO5. We require your approval to go head for further proceeding and hope to get an opportunity to serve you the best .

With thanks and Regards

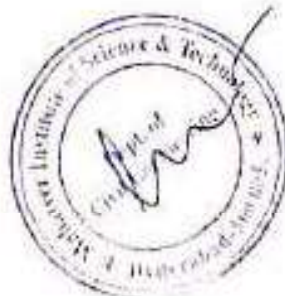

Handwritten signature

PRINCIPAL
"MAHAVEER"
INSTITUTE OF SCIENCE & TECHNOLOGY
Bandlaguda, Hyd-500 085

From,
Civil Department
Mist,
Bandlaguda,
Hyderabad.

Vysapuri, Bandlaguda Post:Keshavgiri,
Hyderabad-500 005, Telangana INDIA
Tel: 040-64556979,20020773, Fax: 040-24455003
E-mail: principal.mahaveer@gmail.com
Website: www.mist.ac.in.

MAHAVEER
INSTITUTE OF SCIENCE & TECHNOLOGY
Approved by AICTE, Affiliated to JNTUH,Hyd.



Date: 01.08.2016

CIRCULAR

Technical Training for IV B. Tech students are starting from 20TH AUG, 2016 onwards. All HODs and Placements coordinators have to manage the trainings and ensure 95% attendance all through the sessions.

All Mentors need to send the compiled feedback report to CH. Swethamber , HOD at e3hod.civil@gmail.com daily.

Agenda: 1. Introduction to GEOS SOFTWARE.

CH.SWETHAMBER
HOD

Design by: B.RAMANA KUMAR
K.MAHESH KUMAR



Kishu
PRINCIPAL
MAHAVEER
INSTITUTE OF SCIENCE & TECHNOLOGY
Bandlaguda, Hyderabad

Vysapuri, Bandlaguda Post, Keshavnagar,
Hyderabad-500 805, Telangana INDIA
Tel: 040-64506979, 20020773, Fax: 040-24453003
E-mail: principal.mahaveer@gmail.com,
Website: www.mist.ac.in,

MAHAVEER

INSTITUTE OF SCIENCE & TECHNOLOGY

Approved by AICTE, Affiliated to JNTUH, Hyd.



GEOS SOFTWARE

1: Getting Started with GEOS

- 1) Design of a cantilever wall
- 2) Verification of a gravity wall
- 3) Design of a non-anchored retaining wall
- 4) Design of an anchored retaining wall
- 5) Verification of a multi anchored wall
- 6) Slope stability analysis
- 7) Design of the geometry of a spread footing
- 8) Settlement of a spread footing
- 9) Analysis of a consolidation under embankment
- 10) Pile foundations-introduction.



Kishu

PRINCIPAL
MAHAVEER

INSTITUTE OF SCIENCE & TECHNOLOGY

Bandlaguda, Hyderabad - 500 805

Vysapuri, Bandlaguda Post:Keshavgi,
Hyderabad-500 005, Telangana INDIA
Tel: 040-64598979,20020773, Fax: 040-24455003
E-mail: principal.mahaveer@gmail.com,
Website: www.mist.ac.in,

MAHAVEER

INSTITUTE OF SCIENCE & TECHNOLOGY
Approved by AICTE, Affiliated to JNTUH,Hyd.



GEO5 SOFTWARE COURSE CIVIL ENGINEERING			
B.TECH IV YEAR I SEM 2016-17 BATCH			YEAR
S.No	Hall Ticket No.	Name of the Candidate	IV
1	13E31A0101	A AAKASH GOUD	IV
2	13E31A0103	AKKINAPPELLY ARAVIND	IV
3	13E31A0104	ALE SANATHI KUMAR	IV
4	13E31A0106	ANDRALA VIJAYA	IV
5	13E31A0107	B SRIVANI	IV
6	13E31A0108	BATHHULA VINAY	IV
7	13E31A0109	BEKKAM SHARAN KUMAR	IV
8	13E31A0110	CHIENNADI KAVYASREE	IV
9	13E31A0111	CHITYALA KARNAKAR	IV
10	13E31A0112	CHUKKA RANJITHKUMAR	IV
11	13E31A0113	DABBA ROHITH	IV
12	13E31A0114	DIVITI DEEKSHA	IV
13	13E31A0115	G. MAHESH KUMAR	IV
14	13E31A0116	GOLI SANDEEP SHAHLI	IV
15	13E31A0117	GOPIREDDY SOMASHEKAR REDDY	IV
16	13E31A0118	GURRAM RAGHAVENDHAR	IV
17	13E31A0119	IREAN AHMED KHAN	IV
18	13E31A0120	MD FAIYAZ	IV



K. Srinivas
PRINCIPAL
MAHAVEER
INSTITUTE OF SCIENCE & TECHNOLOGY
Bandlaguda, Hyd-500 005

19	13E31A0121	KARUMANCHI VAMSI KRISHNA	IV
20	13E31A0122	KASTURI RAKESH	IV
21	13E31A0123	KONDABATHIULA RAJESH	IV
22	13E31A0124	KOUSALYA	IV
23	13E31A0125	MADHAVI KISHORE KUMAR	IV
24	13E31A0126	MADDOORI VIJAY	IV
25	13E31A0127	MD MASROOR ALAM	IV
26	13E31A0128	MEDIPELLY VINOD REDDY	IV
27	13E31A0129	MEGHAVATHI RENUKA	IV
28	13E31A0130	MENDE SUSHANTH ENOCH	IV
29	13E31A0131	MENGA NAVEEN KUMAR	IV
30	13E31A0132	MIRZA MOHAMMED ALI BAIG	IV
31	13E31A0133	MOHAMMED ILYASUDDIN	IV
32	13E31A0134	MOHAMMED MOUAZZAM	IV
33	13E31A0135	MOHD ANAS RAFFEO	IV
34	13E31A0136	MOHD SHAROF AHMED	IV
35	13E31A0137	MUJIGELA VISHWATEJA	IV
36	13E31A0138	MUSKU SANTOSH	IV
37	13E31A0139	NALUVALA NAGESH KUMAR	IV
38	13E31A0140	PERIKA KRISHNA	IV
39	13E31A0141	PRAKASH PALLE	IV
40	13E31A0142	R.VINOD KUMAR	IV
41	13E31A0143	S K SHANAWAZ	IV
42	13E31A0144	S SHIVA KUMAR	IV
43	13E31A0145	SHANEGALA KAPIL KUMAR	IV
44	13E31A0146	SHIV SHANKER SINGH	IV



K. S. S.
PRINCIPAL
MAHAVEER
INSTITUTE OF SCIENCE & TECHNOLOGY
 Bandlaguda, Hyd-500 605.

45	13E31A0147	SHIVARATRI DIVYA	IV
46	13E31A0148	SYED AHAMED MAHBOOB ALI	IV
47	13E31A0150	ULLI SAI KIRAN	IV
48	13E31A0151	VEERABOINA SRINIVAS	IV
49	13E31A0152	VEESAM SUSMITHA	IV
50	14E35A0101	BIRADHAR ESHWAR RAO	IV
51	14E35A0102	AKULA MAHESH	IV
52	14E35A0103	MD. IMTHIYAZ HUSSAIN	IV
53	14E35A0104	NUNAVATHI MOTHILAL	IV
54	14E35A0105	BANDHARABOINA RAMESH	IV



Kshiraj

PRINCIPAL
MAHAVEER

INSTITUTE OF SCIENCE & TECHNOLOGY
Barkhaguda, Hyd-500 005

MAHAVEER INSTITUTE OF SCIENCE & TECHNOLOGY, HYDERABAD
CIVIL ENGINEERING STUDENTS ATTENDANCE

B.TECH IV YEAR I SEM 2016-2017 BATCH II (Date :20-8-2016 to 31-8-2016)

S.No	Hall Ticket No	Name of the Candidate	1	2	3	4	5	6	7	8	9	10
1	13E31A0101	A AAKASH GOUD	P	P	P	P	A	P	P	P	A	P
2	13E31A0103	AKKINAPELLY ARAVIND	P	P	P	P	P	P	P	A	A	P
3	13E31A0104	ALE SANATH KUMAR	P	P	P	P	P	P	P	P	P	A
4	13E31A0106	ANDRALA VIJAYA	P	P	P	P	P	A	P	P	P	P
5	13E31A0107	B SRIVANI	P	P	P	P	P	P	P	P	A	A
6	13E31A0108	BATHULA VINAY	P	P	P	P	P	P	P	P	P	P
7	13E31A0109	BEKKAM SHARAN KUMAR	P	P	P	P	P	P	A	P	A	P
8	13E31A0110	CHENNADI KAVYASREE	P	P	P	P	P	P	P	P	A	P
9	13E31A0111	CHITYALA KARNAKAR	P	P	P	P	P	P	P	A	P	P
10	13E31A0112	CHUKKA RANJITHKUMAR	P	P	P	P	P	P	P	P	P	P
11	13E31A0113	DABBA ROHITH	P	P	P	P	P	P	P	P	P	P
12	13E31A0114	DIVITI DEEKSHA	P	P	P	P	P	P	P	P	P	P
13	13E31A0115	G. MAHESH KUMAR	P	P	P	P	P	P	P	P	P	P
14	13E31A0116	GOLI SANDEEP SHAHIL	P	P	P	P	P	P	P	P	P	P
		GOPIREDDY SOMASHEKAR	P	P	P	P	P	P	P	A	P	P
15	13E31A0117	REDDY	P	P	P	P	P	P	P	P	P	P
16	13E31A0118	GURRAM RAGHAVENDIAR	P	P	P	P	P	P	A	P	P	P
17	13E31A0119	IRFAN AHMED KHAN	P	P	P	P	P	P	P	P	A	P
18	13E31A0120	MD FAIYAZ	P	P	P	P	P	P	P	P	P	A
19	13E31A0121	KARUMANCHI VAMSI KRISHNA	P	P	P	P	P	P	P	A	P	P
20	13E31A0122	KASTURI RAKESH	P	P	P	P	P	P	P	A	P	P
21	13E31A0123	KONDA BATHULA RAJESH	P	P	P	P	P	P	P	P	P	P
22	13E31A0124	KOUSALYA	P	P	P	P	P	P	P	A	P	P
23	13E31A0125	MADHAVI KISHORE KUMAR	P	P	P	P	P	P	P	P	P	P
24	13E31A0126	MADDOORI VIJAY	P	P	P	P	P	P	P	A	P	P



PRINCIPAL
MAHAVEER
INSTITUTE OF SCIENCE & TECHNOLOGY
 Bandlaguda, Hyd-500 085.

Vysapuri, Bandlaguda Post:Keshavpuri,
Hyderabad-500 005, Telangana INDIA
Tel: 040-64595979,20020773, Fax: 040-24455093
E-mail: principal.mahaveer@gmail.com,
Website: www.mist.ac.in,

MAHAVEER

INSTITUTE OF SCIENCE & TECHNOLOGY
Approved by AICTE, Affiliated to JNTUH,Hyd.



Technical Training Exam on GEO5 Software
(A.Y-2016-17)

2x10=20 Marks

Answer All the Questions

- 1.What is GEO5 SOFTWARE ?
- 2.What are the Uses of The GEO5 SOFTWARE ?.

Kshalya
PRINCIPAL
MAHAVEER
INSTITUTE OF SCIENCE & TECHNOLOGY
Bandlaguda, Hyd 500 005

Vysapuri, Bandlaguda Post:Koshavgirl,
Hyderabad-500 805, Telangana InDIA.
Tel: 040-64596979,20920773, Fax: 040-24455003
E-mail: principalmahaveer@gmail.com,
Website: www.mist.ac.in,

MAHAVEER

INSTITUTE OF SCIENCE & TECHNOLOGY
Approved by AICTE, Affiliated to JNTUH,Hyd.



GEO5 SOFTWARE COURSE CIVIL ENGINEERING

B.TECH IV YEAR I SEM 2016-17 BATCH

S.No	Hall Ticket No.	Name of the Candidate	YEAR	Marks	Pass/F
1	13E31A0101	A AAKASH GOUD	IV	16	Pass
2	13E31A0103	AKKINAPPELLY ARAVIND	IV	15	Pass
3	13E31A0104	ALE SANATH KUMAR	IV	14	Pass
4	13E31A0106	ANDRALA VIJAYA	IV	15	Pass
5	13E31A0107	B SRIVANI	IV	12	Pass
6	13E31A0108	BATTHULA VINAY	IV	13	Pass
7	13E31A0109	BEKKAM SHARAN KUMAR	IV	13	Pass
8	13E31A0110	CHENNADI KAVYASREE	IV	14	Pass
9	13E31A0111	CHITYALA KARNAKAR	IV	16	Pass
10	13E31A0112	CHUKKA RANJITHKUMAR	IV	15	Pass
11	13E31A0113	DABBA ROHITH	IV	15	Pass
12	13E31A0114	DIVITI DEEKSHA	IV	14	Pass
13	13E31A0115	G. MAHESH KUMAR	IV	13	Pass
14	13E31A0116	GOLI SANDEEP SHAHIL	IV	14	Pass
15	13E31A0117	GOPIREDDY SOMASHEKAR REDDY	IV	12	Pass
16	13E31A0118	GURRAM RAGHAVENDHAR	IV	15	Pass
17	13E31A0119	IRFAN AHMED KHAN	IV	14	Pass
18	13E31A0120	MD FAIYAZ	IV	15	Pass



K. Subh
PRINCIPAL
MAHAVEER
INSTITUTE OF SCIENCE & TECHNOLOGY
Bandlaguda, Hyd-500 005.

19	13E31A0121	KARUMANCHI VAMSI KRISHNA	IV	14	Pass
20	13E31A0122	KASTURI RAKESH	IV	12	Pass
21	13E31A0123	KONDABATHULA RAJESH	IV	15	Pass
22	13E31A0124	KOUSALYA	IV	16	Pass
23	13E31A0125	MADHAVI KISHORE KUMAR	IV	14	Pass
24	13E31A0126	MADDOORI VIJAY	IV	15	Pass
25	13E31A0127	MD MASROOR ALAM	IV	14	Pass
26	13E31A0128	MEDIPELLY VINOD REDDY	IV	15	Pass
27	13E31A0129	MEGHAVATH RENUKA	IV	16	Pass
28	13E31A0130	MENDE SUSHANTH ENOCH	IV	15	Pass
29	13E31A0131	MENGA NAVEEN KUMAR	IV	14	Pass
30	13E31A0132	MIRZA MOHAMMED ALI BAIG	IV	15	Pass
31	13E31A0133	MOHAMMED ILYASUDDIN	IV	12	Pass
32	13E31A0134	MOHAMMED MOUAZZAM	IV	13	Pass
33	13E31A0135	MOHD ANAS RAFEEQ	IV	14	Pass
34	13E31A0136	MOHD SHARAZ AHMED	IV	12	Pass
35	13E31A0137	MUJIGELA VISHWATEJA	IV	16	Pass
36	13E31A0138	MUSKU SANTOSH	IV	14	Pass
37	13E31A0139	NALUVALA NAGESH KUMAR	IV	15	Pass
38	13E31A0140	PERIKA KRISHNA	IV	13	Pass
39	13E31A0141	PRAKASHI PALLE	IV	12	Pass
40	13E31A0142	R.VINOD KUMAR	IV	13	Pass
41	13E31A0143	S K SHANAWAZ	IV	15	Pass
42	13E31A0144	S SHIVA KUMAR	IV	16	Pass
43	13E31A0145	SHANEGALA KAPIL KUMAR	IV	14	Pass
44	13E31A0146	SHIV SHANKER SINGH	IV	12	Pass



Kanhu
PRINCIPAL
MAHAVEER
 INSTITUTE OF SCIENCE & TECH. OF
 Bandlaguda, Hyd-500 003

45	13E31A0147	SHIVARATRI DIVYA	IV	13	Pass
46	13E31A0148	SYED AHAMED MAHBOOB ALI	IV	13	Pass
47	13E31A0150	ULLI SAI KIRAN	IV	15	Pass
48	13E31A0151	VEERABOINA SRINIVAS	IV	16	Pass
49	13E31A0152	VEESAM SUSMITHA	IV	14	Pass
50	14E35A0101	BIRADHAR ESHWAR RAO	IV	15	Pass
51	14E35A0102	AKULA MAHESH	IV	13	Pass
52	14E35A0103	MD. IMTHIYAZ HUSSAIN	IV	12	Pass
53	14E35A0104	NUNAVATH MOTHILAL	IV	12	Pass
54	14E35A0105	BANDIHARABOINA RAMESH	IV	15	Pass



Handwritten signature in green ink

**PRINCIPAL
MAHAVEER**

INSTITUTE OF SCIENCE & TECHNOLOGY
Bandlaguda, Hyd-500 005.

Vysapuri, Bandlaguda Post:Keshavgi,
Hyderabad-500 805, Telangana INDIA
Tel: 040-64596979,20020773, Fax: 040-24455003
E-mail: principal.mahaveer@gmail.com,
Website: www.mist.ac.in,

MAHAVEER
INSTITUTE OF SCIENCE & TECHNOLOGY
Approved by AICTE, Affiliated to JNTUH,Hyd.



GEO5 COURSE

Summery

Department of Civil Engineering

- Use GEO5 for daily working process.
- Navigate throughout GEO5 using major navigating tools.
- Understand the concept and techniques to draw.
- Create multiple designs using several of tools.
- Create layers to control the objects' visibility.
- Explain drawing using annotations.
- Plot or print the drawing by scale.
- To use constraint for certain design.



Principal

PRINCIPAL
MAHAVEER
INSTITUTE OF SCIENCE & TECHNOLOGY
Bandlaguda, Hyd-500 805

Vysapuri, Bandlaguda Post:Keshavnagar,
Hyderabad-500 005, Telangana INDIA
Tel: 040-64556979,20020773, Fax: 040-24455003
E-mail: principal.mahaveer@gmail.com,
Website: www.mistac.in,

MAHAVEER

INSTITUTE OF SCIENCE & TECHNOLOGY
Approved by AICTE, Affiliated to JNTU,Hyd.



CERTIFICATE OF COURSE COMPLETION

This certificate is presented to _____ of MIST, who has successfully completed technical training course on "GEO5" held from _____ to _____ and found the student performance to be excellent.



ESTD : 2001

CH.SWETHAMBER

HOD

Civil Department



K. S. Mahaveer

PRINCIPAL

MAHAVEER

INSTITUTE OF SCIENCE & TECHNOLOGY
bandlaguda, Hyd 500 005.

Vysapuri, Bandlaguda Post:Keshavgiri,
Hyderabad-500 065, Telangana INDIA
Tel: 040-84596979,20020773, Fax: 040-24455003
E-mail: principal.mahaveer@gmail.com,
Website: www.mist.ac.in,

MAHAVEER
INSTITUTE OF SCIENCE & TECHNOLOGY
Approved by AICTE, Affiliated to JNTUH,Hyd.



PROPOSAL LETTER

Hyderabad,

10/03/2016.

To
The principal,
MIST,
Hyderabad.

Sub: Proposal for three weeks workshop on STADD PROVIS-Reg.

Dear Sir,

We are working as asst professor in the department of CIVIL ENGINEERING. Sir, we are going to conduct three weeks workshop on STADD PROVIS. We require your approval to go head for further proceeding and hope to get an opportunity to serve you the best .

With thanks and Regards

Civil Department,

From,

Mist,
Bandlaguda,
Hyderabad.



Mahaveer
PRINCIPAL
MAHAVEER
INSTITUTE OF SCIENCE & TECHNOLOGY
BANDLAGUDA, HYDERABAD

Vysapuri, Bandlaguda Post; Keshavnagar,
Hyderabad-500 065, Telangana INDIA
Tel: 040-64596979, 20020773, Fax: 040-24455003
E-mail: principal.mahaveer@gmail.com,
Website: www.mist.ac.in,

MAHAVEER

INSTITUTE OF SCIENCE & TECHNOLOGY
Approved by AICTE, Affiliated to JNTU, Hyd



Date: 14.03.2016

CIRCULAR

Technical Training for IV B. Tech students are starting from 14th March, 2016 onwards.
All HODs and Placements coordinators have to manage the trainings and ensure 95% attendance all through the sessions.

All Mentors need to send the compiled feedback report to HOD at e3hod.civil@gmail.com daily.

Agenda: I. Introduction to STAAD .Provi8.

DESIGNED BY

CH. SWETHAMBER
GARUNA

CH. SWETHAMBER
HOD

PRINCIPAL
MAHAVEER
INSTITUTE OF SCIENCE & TECHNOLOGY
Bandlaguda, Hyd-500 065.





STAAD.ProV8 SYLLABUS

Chapter 1: Before you start using Bentley STAAD.ProV8

- Understanding Unit Conversion Tables
- Overview of Structural Design & Analysis
- Stresses and Strains
- Shear Force & Bending Moment Diagrams
- Introduction to Types of Structures
- Overview of Steel, Concrete and Foundation Design
- Introduction to Finite Element Analysis

Chapter 2: Introduction to STAAD.ProV8

- About Bentley STAAD.Pro
- Starting STAAD.Pro
- Graphical User Interface
- Starting a New Project
- Working with User Interfaces:
 - Menu Bars
 - Tool Bars
 - Tabs
 - Snap Node / Beam Window
 - Data Area
 - Main Window
- Opening and Existing Project
- Saving a Project
- Configuring Units
- Keyboard Shortcuts
- Importing Model in STAAD.Pro
- Coordinate Systems

Chapter 3: Structural Modeling

- Adding Beams using Tools
- Creating Beams (Collinear, Along Axes)
- Creating Plates
- Creating Surfaces
- Creating Solid Elements
- Creating Structure
- Stretching and Intersecting Members
- Merging Members and Nodes
- Renumbering Nodes, Members and Elements
- Splitting and Breaking Beams
- Cutting Sections



K. Srinivas

PRINCIPAL
MAHAVEER
INSTITUTE OF SCIENCE & TECHNOLOGY
Bandlaguda, Hyderabad

Chapter 4: Material Constants and Section Properties

- a. Material Constants
- b. Creating and Editing Material Properties
- c. Assigning Materials to the Structure
- d. Orthotropic Materials
- e. Section Properties
 - Prismatic Sections
 - Tapered Sections
 - Steel Sections
 - Steel Joist and Joist Girders
 - Plate/Surface Thickness

Chapter 5: Member Specifications and Supports

- a. Node Specification
- b. Member Specifications
 - Release
 - Offset
 - Property Reduction Factors
 - Cable
 - Truss
 - Compression
 - Tension
 - Inactive
- c. Plate Specifications
 - Release
 - Ignore Inplane Rotation
 - Plane Stress
- d. Supports:
 - Fixed
 - Pinned
 - Fixed But
 - Enforced
 - Enforced But
 - Multilinear Spring
 - Foundation
 - Inclined
 - Tension/Compression Only Springs

Chapter 6: Loads

- a. Types of Loads: Self weight, Nodal, Member, Area, Floor, Plate, Surface and Solid,
- b. Load Generation
- c. Load Combinations

Chapter 7: Performing Analysis

- a. PreAnalysis
 - Problem Statistics
 - Joint Coordinates
 - Member Information
 - Material Properties
 - Support Information
 - Element & Solid Information
- b. Performing Analysis

Chapter 8: Post Processing & Report Creation

- a. Post Analysis Print
 - Load Lists
 - Joint Displacement



MahaVeer
PRINCIPAL
MAHAVEER
INSTITUTE OF SCIENCE & TECHNOLOGY
Bandlaguda, Hyd-500 005.

- MemberForces
 - SupportReactions
 - CG
 - ModeShapes
 - SectionDisplacement
 - Analysis Results
 - MemberStresses
 - ElementForces/Stresses
- b. ViewingResults
c. OutputFile
d. Post ProcessingMode

Chapter 9: Analysis Case Studies / Workshops

- a. RCCDesign&Analysis(BeamsandColumns)
b. SteelDesign&Analysis(FramesandTrusses)
c. MiscellaneousAnalysis
d. Practice examples forStudents



K. Srinivas
PRINCIPAL
MAHAVIR
INSTITUTE OF SCIENCE & TECHNOLOGY
Bandlaguda, Hyd-500 005.

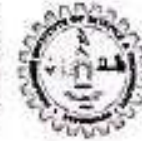

Department of Civil Engineering
STAAD.ProV8 Technical Training student attendance list 2016-17

SL.NO.	ROLL NO.	NAME OF THE STUDENT	YEAR
1	13E31A0101	A AAKASH GOUD	IV
2	13E31A0103	AKKINAPPELLY ARAVIND	IV
3	13E31A0104	ALE SANATH KUMAR	IV
4	13E31A0106	ANDRALA VIJAYA	IV
5	13E31A0107	B SRIVANI	IV
6	13E31A0108	BATTHULA VINAY	IV
7	13E31A0109	BEKKAM SHARAN KUMAR	IV
8	13E31A0110	CHENNADI KAVYASREE	IV
9	13E31A0111	CHITYALA KARNAKAR	IV
10	13E31A0112	CHUKKA RANJITHKUMAR	IV
11	13E31A0113	DABBA ROHITH	IV
12	13E31A0114	DIVITI DEEKSHA	IV
13	13E31A0115	G. MAHESH KUMAR	IV
14	13E31A0116	GOLI SANDEEP SHAHIL	IV
15	13E31A0117	GOPIREDDY SOMASHEKAR REDDY	IV
16	13E31A0118	GURRAM RAGHAVENDHAR	IV
17	13E31A0119	IRFAN AHMED KHAN	IV
18	13E31A0120	MD FAIYAZ	IV
19	13E31A0121	KARUMANCHI VAMSI KRISHNA	IV
20	13E31A0122	KASTURI RAKESH	IV
21	13E31A0123	KONDABATHULA RAJESH	IV
22	13E31A0124	KOUSALYA	IV
23	13E31A0125	MADHAVI KISHORE KUMAR	IV
24	13E31A0126	MADDOORI VIJAY	IV
25	13E31A0127	MD MASROOR ALAM	IV
26	13E31A0128	MEDIPELLY VINOD REDDY	IV
27	13E31A0129	MEGHAVATH RENUKA	IV
28	13E31A0130	MENDE SUSHANTH ENOCH	IV
29	13E31A0131	MENGA NAVEEN KUMAR	IV
30	13E31A0132	MIRZA MOHAMMED ALI BAIG	IV
31	13E31A0133	MOHAMMED ILYASUDDIN	IV
32	13E31A0134	MOHAMMED MOUJAZAM	IV
33	13E31A0135	MOHD ANAS RAFAEQ	IV
34	13E31A0136	MOHD SHAROF AHMED	IV
35	13E31A0137	MUJIGETA VISHWATEJA	IV
36	13E31A0138	MUSKIL SANTOSH	IV



Principal
MAHAVEER
INSTITUTE OF SCIENCE & TECHNOLOGY
Bandlaguda, Hyd-500 005.

37	13E31A0139	NALLIVALA NAGESH KUMAR	IV
38	13E31A0140	PERIKA KRISHNA	IV
39	13E31A0141	PRAKASH PALLE	IV
40	13E31A0142	R.VINOD KUMAR	IV
41	13E31A0143	S K SHANAWAZ	IV
42	13E31A0144	S SHIVA KUMAR	IV
43	13E31A0145	SHANEGALA KAPIL KUMAR	IV
44	13E31A0146	SHIV SHANKER SINGH	IV
45	13E31A0147	SHIVARATRI DIVYA	IV
46	13E31A0148	SYED AHAMED MAHBOOB ALI	IV
47	13E31A0150	ULLI SAI KIRAN	IV
48	13E31A0151	VEERABOINA SRINIVAS	IV
49	13E31A0152	VEESAM SUSMITHA	IV
50	14E35A0101	BIRADHAR ESHWAR RAO	IV
51	14E35A0102	AKULA MAHESH	IV
52	14E35A0103	MD. IMTHIYAZ HUSSAIN	IV
53	14E35A0104	NUNAVATH MOTHILAL	IV
54	14E35A0105	BANDHARABOINA RAMESH	IV



K. Srinivas
 PRINCIPAL
 MOHAJVEER
 INSTITUTE OF SCIENCE & TECHNOLOGY
 Bandlaguda, Hyd 500 085.



Department of Civil Engineering STAAD.Pro V18 Technical Training student attendance list 2016-17

SNO	Roll No	Name of the student	YEAR	MARKS	PASS/FAIL
1	13E31A0101	A AAKASH GOUD	IV	16	PASS
2	13E31A0103	AKKINAPPELLY ARAVIND	IV	16	PASS
3	13E31A0104	ALE SANATH KUMAR	IV	12	PASS
4	13E31A0106	ANDRALA VIJAYA	IV	12	PASS
5	13E31A0107	B SRIVANI	IV	16	PASS
6	13E31A0108	BATTHULA VINAY	IV	16	PASS
7	13E31A0109	BEKKAM SHARAN KUMAR	IV	16	PASS
8	13E31A0110	CHENNADI KAVYASREE	IV	16	PASS
9	13E31A0111	CHITYALA KARNAKAR	IV	16	PASS
10	13E31A0112	CHUKKA RANJITHKUMAR	IV	16	PASS
11	13E31A0113	DABBA ROHITH	IV	16	PASS
12	13E31A0114	DIVITI DEEKSHA	IV	16	PASS
13	13E31A0115	G. MAHESH KUMAR	IV	16	PASS
14	13E31A0116	GOLI SANDEEP SHAHIL	IV	16	PASS
15	13E31A0117	GOPIREDDY SOMASHEKAR REDDY	IV	16	PASS
16	13E31A0118	GURRAM RAGHAVENDHAR	IV	16	PASS
17	13E31A0119	IRFAN AHMED KHAN	IV	16	PASS
18	13E31A0120	MD FAIYAZ	IV	16	PASS
19	13E31A0121	KARUMANCHI VAMSI KRISHNA	IV	15	PASS
20	13E31A0122	KASTURI RAKESH	IV	16	PASS
21	13E31A0123	KONDABATHULA RAJESH	IV	16	PASS
22	13E31A0124	KOUSALYA	IV	15	PASS
23	13E31A0125	MADHAVI KISHORE KUMAR	IV	16	PASS
24	13E31A0126	MADDOORI VIJAY	IV	14	PASS
25	13E31A0127	MD MASROOR ALAM	IV	15	PASS
26	13E31A0128	MEDIPELLY VINOD REDDY	IV	15	PASS
27	13E31A0129	MEGHAVATH RENUKA	IV	16	PASS
28	13E31A0130	MENDI SUSHANTH ENOCH	IV	14	PASS
29	13E31A0131	MENGA NAVEEN KUMAR	IV	16	PASS
30	13E31A0132	MIRZA MOHAMMED ALI BAIG	IV	15	PASS
31	13E31A0133	MOHAMMED ILYASUDDIN	IV	14	PASS
32	13E31A0134	MOHAMMED MOUAZZAM	IV	18	PASS
33	13E31A0135	MOHD ANAS RAFAEEQ	IV	15	PASS
34	13E31A0136	MOHD SHAROF AHMED	IV	16	PASS
35	13E31A0137	MURGELA VISHWATEJA	IV	15	PASS
36	13E31A0138	MUSKU SANTOSH	IV	16	PASS



K. Venkatesh
PRINCIPAL
MAHAVEER
INSTITUTE OF SCIENCE & TECHNOLOGY
Bandlaguda, Hyd-500 005.

37	13E31A0139	MALUVALA NAGESH KUMAR	IV	16	PASS
38	13E31A0140	PERIKA KRISHNA	IV	15	PASS
39	13E31A0141	PRAKASH PALLE	IV	16	PASS
40	13E31A0142	R.VINOD KUMAR	IV	16	PASS
41	13E31A0143	S K SHANAWAZ	IV	15	PASS
42	13E31A0144	S SHIVA KUMAR	IV	16	PASS
43	13E31A0145	SHANEGALA KAPIL KUMAR	IV	14	PASS
44	13E31A0146	SHIV SHANKER SINGH	IV	15	PASS
45	13E31A0147	SHIVARATRI DIVYA	IV	15	PASS
46	13E31A0148	SYED AHAMED MAHBOOB ALI	IV	16	PASS
47	13E31A0150	ULLI SAI KIRAN	IV	14	PASS
48	13E31A0151	VEERABOINA SRINIVAS	IV	16	PASS
49	13E31A0152	VEESAM SUSMITHA	IV	15	PASS
50	14E35A0101	BIRADHAR ESHWAR RAO	IV	14	PASS
51	14E35A0102	AKULA MAHESH	IV	16	PASS
52	14E35A0103	MD. IMTHIYAZ HUSSAIN	IV	16	PASS
53	14E35A0104	NUNAVATHI MOTHILAL	IV	12	PASS
54	14E35A0105	BANDHARABOINA RAMESH	IV	12	PASS



K. S. Veer

PRINCIPAL
VEER

BITTEL - BRITISH & TECHNOLOGY
JNTU Hyderabad, HYD-500 005.

MAHAVEER INSTITUTE OF SCIENCE & TECHNOLOGY, HYDERABAD
CIVIL ENGINEERING STUDENTS ATTENDANCE

S.No	Hall Ticket No	Name of the Candidate	1	2	3	4	5	6	7	8	9	10
1	13E31A0101	A AAKASH GOUD	P	A	P	P	P	P	P	P	P	P
2	13E31A0103	AKKINAPPELLY ARAVIND	P	P	A	P	P	P	P	P	P	P
3	13E31A0104	ALE SANATH KUMAR	P	P	P	A	P	P	P	P	P	P
4	13E31A0106	ANDRALA VIDAYA	P	P	A	P	P	P	P	P	P	P
5	13E31A0107	B SRIVANI	P	P	P	A	P	P	P	P	P	P
6	13E31A0108	BATTHULA VINAY	P	P	A	P	A	A	P	P	P	A
7	13E31A0109	BEKKAM SHARAN KUMAR	P	P	A	P	P	P	P	P	A	P
8	13E31A0110	CHENNADI KAVYASREE	P	A	P	A	P	P	P	P	P	P
9	13E31A0111	CHITYALA KARNAKAR	P	P	A	P	P	P	A	P	P	P
10	13E31A0112	CHUKKA RANJITHKUMAR	P	P	P	P	P	P	P	A	P	P
11	13E31A0113	DABBA ROHITH	P	P	P	A	P	P	P	P	A	A
12	13E31A0114	DIVITI DEEKSHA	P	P	P	A	P	P	A	P	P	P
13	13E31A0115	G. MAHESH KUMAR	P	A	P	P	P	P	P	P	P	P
14	13E31A0116	GOLI SANDEEP SHAHIL	A	P	P	P	A	P	P	P	P	P
15	13E31A0117	GOPREDDY SOMASHEKAR REDDY	P	P	P	P	P	A	P	P	P	P
16	13E31A0118	GURRAM RAGHAVENDHAR	P	P	P	P	P	P	A	P	P	P
17	13E31A0119	IRFAN AHMED KIYAN	A	P	P	P	P	P	P	P	P	A



Handwritten signature

PRINCIPAL
MAHAVEER
INSTITUTE OF SCIENCE & TECHNOLOGY
 Hyderabad, Tel. No. 4123456789



Technical Training Exam on STAAD Pro V8 Software
(A.Y-2016-17)

2x10=20 Marks

Answer All the Questions

- a. Analyse the given beam using Staad Pro Cross section of Beam 200mmx400mm Grade of Concrete M 25 Grade of Steel Fe 415. Plot SFD, BMD and deflected profile.

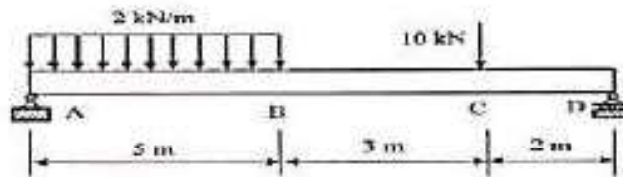

- b. Analyse the given beam using Staad Pro Cross section of Beam 200mmx400mm Grade of Concrete M 30 Grade of Steel Fe 415. Plot SFD, BMD and deflected profile.

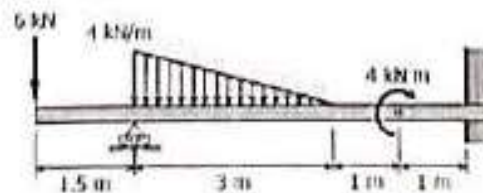

Mahaveer
PRINCIPAL
MAHAVEER
INSTITUTE OF SCIENCE & TECHNOLOGY
Bandlaguda, Hyd 500 005.

- c. Analyse the given beam using Staad Pro Cross section of Beam 200mmx400mm Grade of Concrete M 25 Grade of Steel Fe 415. Plot SFD,BMD and deflected profile.

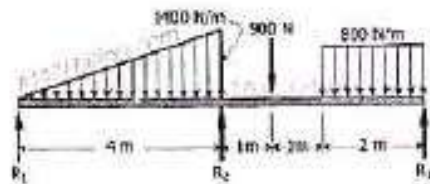

K. S. Mahaveer
PRINCIPAL
MAHAVEER
INSTITUTE OF SCIENCE & TECHNOLOGY
BANGALURU-560 005.

Vysapuri, Bandlaguda Post, Keshavnagar,
Hyderabad-500 005, Telangana INDIA
Tel: 040-64596979, 20020773, Fax: 040-24451003
E-mail: principal.mahaveer@gmail.com
Website: www.mist.ac.in

MAHAVEER

INSTITUTE OF SCIENCE & TECHNOLOGY
Approved by AICTE, Affiliated to JNTUH, Hyd.



STAAD PRO V8 COURSE

Summary

Department of Civil Engineering

- Model Generation and Editing
- Assigning loads
- Creating Load Combinations
- Concrete Design
- Seismology
- Steel Design
- Foundation Designs
- Report Generation and Plotting



K. Srinivas
PRINCIPAL
MAHAVEER
INSTITUTE OF SCIENCE & TECHNOLOGY
Bandlaguda, Hyd-500 005

Vysapuri, Bandlaguda Post:Keshavgiri,
Hyderabad-500 005, Telangana INDIA
Tel: 040-64596979,20020773, Fax: 040-24455003
E-mail: principal.mahaveer@gmail.com,
Website: www.mist.ac.in,

MAHAVEER
INSTITUTE OF SCIENCE & TECHNOLOGY
Approved by AICTE, Affiliated to JNTUH,Hyd.



CERTIFICATE OF COURSE COMPLETION

This certificate is presented to _____ of
MIST, who has successfully completed technical training course
on "STAAD ProVi8" held from _____ to _____
and found the student performance to be excellent.



ESTD : 2001

CH. SWETHAMBER

HOD

Civil department



Principal
PRINCIPAL
MAHAVEER
INSTITUTE OF SCIENCE & TECHNOLOGY
Bandlaguda, Hyderabad, India

Vysapuri, Bandlaguda Post:Keshavgiri,

MAHAVEER



Hyderabad-500 005, TELANGANA INDIA

Tel: 040-64596979,8978380692 Fax: 040-24455003

E-mail: p3hod.eee@gmail.com

Website: www.mist.ac.in

Approved by AICTE, Affiliated to JNTUH,Hyd.

DEPARTMENT OF ELECTRICAL & ELECTRONICS

Date: 1-02-2017

To
The Principal,
Mist,
Hyderabad.

Sub:Proposal for Add on course-Reg.

Respected sir,

We are going to conduct two weeks workshop on **IMPORTANCY OF EARTHING**. We require your approval to go head for further proceeding and hope to get an opportunity to serve you the best.

With thanks and regards

R.V.Amaranth
HOD-EEE

Professor & Head
Dept. of Electrical & Electronics
Mahaveer Institute of Science & Technology
Vysapuri, Bandlaguda, Keshavgiri,
Hyderabad - 500 005.

Keshavgiri
MAHAVEER INSTITUTE OF SCIENCE & TECHNOLOGY
Bandlaguda, Hyd-500 005.

Vysapuri, Bandlaguda Post:Keshavgiri,

MAHAVEER



Hyderabad-500 005, TELANGANA INDIA

Tel: 040-64596979,8970380692, Fax: 040-24455003

E-mail: e3hod.eee@gmail.com,

Website: www.mist.ac.in,

Approved by AICTE, Affiliated to JNTUH,Hyd.

DEPARTMENT OF ELECTRICAL & ELECTRONICS

Date: 01-02-2017

CIRCULAR

Technical Trainings for III B. Tech students are starting from 07-02-2017 onwards. All HODs and placements coordinators have to manage the trainings and ensure 95% attendance all through the sessions.

All mentors need to send the compiled feedback report to HOD at e3hod.eee@gmail.com daily. Mentors are advised to take care of PNR (Students not participating in training).

Agenda: Importancy of Earthing

Design & Development of Curriculum for Add on Courses Faculty names 1. Dr RV AMARNATH

2.G .Prem kumar roddy

K. SRINIVAS
MAHAVEER
INSTITUTE OF SCIENCE & TECHNOLOGY
Bandlaguda, Hyd-500 005.

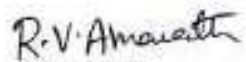
R.V. Amarnath
HOD-EEE
Professor & Head
Dept. of Electrical & Electronics En,
Mahaveer Institute of Science & Technol
Vyasapuri, Bandlaguda, Keshavgiri,
Hyderabad - 500 005.

Vysapuri, Bandlaguda Post:Keshavgirl,

MAHAVEER



Hyderabad-500 005, TELANGANA INDIA

Tel: 040-64596979,8978380692.Fax: 040-24455003

E-mail: e3hod.eee@gmail.com

Website: www.mist.ac.in

Approved by AICTE, Affiliated to JNTUH,Hyd.

DEPARTMENT OF ELECTRICAL & ELECTRONICS

SYLLABUS FOR Importance of Earthing

SNO	TOPIC COVERED	DURATION
1	introduction	3
2	Classification of resistance	3
3	Types of earthing system	3
4	Plate earthing	3
5	Pipe earthing	3
6	Sizes of the conductor	3
7	Running earthing	3
8	Importance of earthing	3
9	Testing for fault	3
10	measuring insulation resistance by insulation tester	3

R.V.Amaranth
HOD-EEE

Kshuf
PRINCIPAL
MAHAVEER
INSTITUTE OF SCIENCE & TECHNOLOGY
Bandlaguda, Hyd-500 005.

Professor & Head
Dept. of Electrical & Electronics Engg
Mahaveer Institute of Science & Technology
Vysapuri, Bandlaguda, Keshavgirl,
Hyderabad - 500 005.

Vysapuri, Bandlaguda Post:Keshavgi,ri,

MAHAVEER



Hyderabad-500 005, TELANGANA INDIA

Tel: 040-64596979,8978380692, Fax: 040-24455003

E-mail: e3hod.eee@gmail.com,

Website: www.mistac.in,

Approved by AICTE, Affiliated to JNTUH,Hyd.

DEPARTMENT OF ELECTRICAL & ELECTRONICS

LIST OF REGISTERED STUDENTS FOR Importance of Earthing

SNO	HALL TICKET NO	NAME OF THE STUDENT
1	14E31A0201	ANANTHARAM SANDEEP KUMAR
2	14E31A0202	ANYARAMBATLA ANUSHA
3	14E31A0203	AREKATLA POOJITHA REDDY
4	14E31A0204	BANDI BHEESHMA REDDY
5	14E31A0205	BHUPATHI HARIKA
6	14E31A0210	ENTI VINAY KUMAR REDDY
7	14E31A0211	K SHRAVAN KUMAR
8	14E31A0213	LOSIRLU SURESH KUMAR
9	14E31A0214	MACCHA SANDEEP
10	14E31A0215	MALLOJU MADHU
11	14E31A0216	MIR ABDUL KAREEM KHAN
12	14E31A0217	MOHAMMED ABDUL VAKEEL
13	14E31A0218	MOHAMMED ABRAR
14	14E31A0219	MOHAMMED YAKUB PASHA
15	14E31A0220	PUVVADA SHALENDRA
16	14E31A0221	RISHAV VERMA
17	14E31A0222	S POOJA
18	14E31A0223	SAPAVATH ANITHA
19	14E31A0224	SOMANABOINA RAGHU
20	14E31A0225	SRIRAM BALA GOUD
21	14E31A0226	SUTHARI MANOJ KUMAR
22	14E31A0227	TALLURI GREESHMA CHOWDARY
23	14E31A0228	VARUKOLU SHEKHAR
24	15E35A0201	AGUMAMIDI SAIRAM
25	15E35A0202	BASAKONDA BHOOMESH
26	15E35A0204	DYAVANAPELLI RAJKUMAR

Keshavgi
Principal
MAHAVEER
INSTITUTE OF SCIENCE & TECHNOLOGY
Bandlaguda, Hyd-500 005.

Vysapuri, Bandlaguda Post:Keshavgiri,

MAHAVEER



Hyderabad-500 005, TELANGANA INDIA

Tel: 040-64596979,8978380692 Fax: 040-24455903

E-mail: g3hod.eee@gmail.com

Website: www.mist.ac.in

Approved by AICTE, Affiliated to JNTU(H)Hyd

DEPARTMENT OF ELECTRICAL & ELECTRONICS

27	ISE35A0205	GUNDAGANI MAHESH
28	ISE35A0206	JAKKAWAR VIDAY
29	ISE35A0207	KATTA SAIKRISHNA
30	ISE35A0208	LAXVEER KHAN
31	ISE35A0209	TEKKAM HARISH
32	ISE31A0215	GADDAM RAKESH

Importancy of Earthing QUESTION PAPER

Duration: 120 Minutes

4 X 5 = 20 Marks

Answer the following all questions. Each question carries 5 mark.

1. What are maximum permissible values of resistance of Earth system?
2. Explain minimum size of the earth continuity conductor?
3. Explain about earthing system?
4. Explain earth resistance exceed the permissible values of resistance of Earth system?

K. Srinivas
PRINCIPAL
MAHAVEER
INSTITUTE OF SCIENCE & TECHNOLOGY
Bandlaguda, Hyd-500 005.

R.V. Anurath
HOD-ELE
Professor & Head
Dept. of Electrical & Electronics Engg
Mahaveer Institute of Science & Technology
Vysapuri, Bandlaguda, Keshavgiri,
Hyderabad - 500 005.

Vysapuri, Bandlaguda Post:Keshavgi,ri,

MAHAVEER



Hyderabad-500 005, TELANGANA INDIA

Tel: 040-64596979,8978380692, Fax: 040-24455003

E-mail: p3hod.eee@gmail.com,

Website: www.mist.ac.in,

Approved by AICTE, Affiliated to JNTUH,Hyd.

DEPARTMENT OF ELECTRICAL & ELECTRONICS

RESULT SHEET FOR Importance of Earthing REGISTERED STUDENTS

SNO	HALL TICKET NO	NAME OF THE STUDENT	MARKS(20)	RESULT
1	14E31A0201	ANANTHARAM SANDEEP KUMAR	20	PASS
2	14E31A0202	ANYARAMBATLA ANUSHA	19	PASS
3	14E31A0203	AREKATLA POOJITHA REDDY	20	PASS
4	14E31A0204	BANDI BHEESHMA REDDY	18	PASS
5	14E31A0205	BHUPATHI HARIKA	20	PASS
6	14E31A0210	ENTI VINAY KUMAR REDDY	20	PASS
7	14E31A0211	K SHRAVAN KUMAR	19	PASS
8	14E31A0213	LOSIRLU SURESH KUMAR	20	PASS
9	14E31A0214	MACCHA SANDEEP	18	PASS
10	14E31A0215	MALLOJU MADHU	20	PASS
11	14E31A0216	MIR ABDUL KAREEM KHAN	20	PASS
12	14E31A0217	MOHAMMED ABDUL VAKEEL	16	PASS
13	14E31A0218	MOHAMMED ABRAR	20	PASS
14	14E31A0219	MOHAMMED YAKUB PASHA	20	PASS
15	14E31A0220	PUVVADA SHAIENDRA	17	PASS
16	14E31A0221	RISHAV VERMA	20	PASS
17	14E31A0222	S POOJA	20	PASS
18	14E31A0223	SAPAVATHI ANITHA	16	PASS
19	14E31A0224	SOMANABOINA RAGHU	20	PASS
20	14E31A0225	SRIRAM BALA GOUD	20	PASS
21	14E31A0226	SUTHARI MANOJ KUMAR	18	PASS
22	14E31A0227	TALLURI GREESHMA CHOWDARY	20	PASS
23	14E31A0228	VARUKOLU SHEKHAR	18	PASS
24	15E35A0201	AGUMAMIDI SAIRAM	20	PASS
25	15E35A0202	BASAKONDA BHOMESH	18	PASS

Kishu
PAL

M I E E
INSTITUTE OF TECHNOLOGY
Bandlaguda, Hyd-500 005,

Vysapuri, Bandlaguda Post:Keshavgiri,

MAHAVEER



Hyderabad-500 005, TELANGANA INDIA

Tel: 040-64596979,8978380692, Fax: 040-24455003

E-mail: e3hod.eee@gmail.com.

Website: www.mist.ac.in,

Approved by AICTE, Affiliated to JNTUH,Hyd.

DEPARTMENT OF ELECTRICAL & ELECTRONICS

26	15E35A0204	DYAVANAPELLI RAJKUMAR	20	PASS
27	15E35A0205	GUNDAGANI MAHESH	20	PASS
28	15E35A0206	JAKKAWAR VIJAY	18	PASS
29	15E35A0207	KATTA SAIKRISHNA	20	PASS
30	15E35A0208	TANVEER KHAN	19	PASS
31	15E35A0209	TEKKAM HARISH	20	PASS
32	13E31A0215	GADDAM RAKESH	18	PASS

No. of students Registered:32

No. of students Passed:32

No. of students failed:NIL

R.V. Anant

Professor & Head

Dept. of Electrical & Electronics
Mahaveer Institute of Science & Tech
Vysapuri, Bandlaguda, Keshavgiri,
Hyderabad - 500 005.

K. Srinivas

PRINCIPAL
MAHAVEER
INSTITUTE OF SCIENCE & TECHNOLOGY
Bandlaguda, Hyd-500 005.

Vysapuri, Bandlaguda Post:Keshavgiri,

MAHAVEER



Hyderabad-500 005, TELANGANA INDIA

Tel: 040-64596979,8978380692, Fax: 040-24455003

E-mail: e3hod.eee@gmail.com,

Website: www.mist.ac.in,

Approved by AICTE, Affiliated to JNTUH,Hyd.

DEPARTMENT OF ELECTRICAL & ELECTRONICS

SUMMARY REPORT OF Importancy of Earthing

Earthing is used to protect you from an electric shock. It does this by providing a path (a protective conductor) for a fault current to flow to earth. It also causes the protective device (either a circuit-breaker or fuse) to switch off the electric current to the circuit that has the fault.

COORDINATOR

Copy to:

1. Department Notice Board
2. Principal for Information
3. Committee Members (Academic)



PRINCIPAL
MAHAVEER
INSTITUTE OF SCIENCE & TECHNOLOGY
Bandlaguda, Hyd-500 005.

A Two week Certificate Course
On
"Importancy of Earthing"
(7th - 25th feb 2017)

REGISTRATION FORM

Full Name:

Designation:

Organization:

Experience (in years):

Industry:..... Teaching:.....

Research:.....

Correspondence Address:.....

.....

E- mail id for communication (must):

.....

Ph:

Sign of Applicant:

Signature of
 Head of the Institution with official Seal

Important Dates
 Last date of Receiving Applications: 05.2.2017
 Intimation to the selected participants: 6.2.2017

- General Information:**
- > Tea, snacks and lunch will be served.
 - > Certificate will be issued to all the participants.
 - > Transportation will be provided from city to college.
 - > Limited accommodation will be provided on request from participants.

About the College:
 An Institute committed to quality education MIST aims at providing learning with a technology edge. Right from its inception in 2011, it has turning itself to meet this objective. It endeavors to provide consistent training to the students to help them evolve as competent professionals in the highly competitive world.

About the Department:
 The Department of E.E.E is working with a mission to contribute through excellence in technical education, with research orientation. It imparts ethical & moral values to the student's so as to make them emerge as responsible professionals. With its experienced faculty members having excellent academic backgrounds, it trains students supplementing classroom lectures with computer aided demonstrations making their learning a rich and rewarding experience.

Resource person:Dr.M.Rajendar Reddy

Contact Details:

Co-ordinators
Dr.R.V.Amaranath

Head EEE Dept.MIST

Co-convenor
Mr.G. Prem Kumar Reddy,

Assoc.Prof., EEE Dept,MIST

College Numbers: Tel: 04065810046,8979380692,
 Email: e3hod.eee@gmail.com,

A Two week Certificate Course
On
"Importancy of Earthing"
(7th - 25th feb 2017)



Organizing Secretary

Chief Patron

Set. S.Sudershan Reddy, Chairman, MIST

Set. S. Surinder Reddy, Secretary, MIST

Set. S. Dharamraj Reddy, Joint Secretary, MIST

Patron

Dr.KSSSN Reddy, Principal, MIST

Organized by



Department of Electrical & Electronics Engineering

Mahaveer Institute of Science & Technology
 Vyasaquri, Bandlaguda, Hyderabad 500005
 (Affiliated to JNTU/H)

4.Importance of Earthing

After: 26/08/2019 1 2 3 4 5 6 7 8 9 10 11 12 13 14 15 16 17 18 19 20 21 22 23 24 25 26 27 28 29 30

SNO	HALL TICKET	NAME OF THE STUDENT	1	2	3	4	5	6	7	8	9	10	11	12	13	14	15	16	17	18	19	20	21	22	23	24	25	26	27	28	29	30					
1	14E31A0201	ANANTHARAM SANDEEP K	P	P	P	P	P	P	P	P	P	P	P	P	P	P	P	P	P	P	P	P	P	P	P	P	P	P	P	P	P	P	P				
2	14E31A0202	ANYARAMBATLA ANUSHA	P	P	P	P	P	P	P	P	P	P	P	P	P	P	P	P	P	P	P	P	P	P	P	P	P	P	P	P	P	P	P	P			
3	14E31A0203	AREKATLA POOJITHA REDDY	P	P	P	P	P	P	P	P	P	P	P	P	P	P	P	P	P	P	P	P	P	P	P	P	P	P	P	P	P	P	P	P	P		
4	14E31A0204	BANDI BHEESHMA REDDY	P	P	P	P	P	P	P	P	P	P	P	P	P	P	P	P	P	P	P	P	P	P	P	P	P	P	P	P	P	P	P	P	P	P	
5	14E31A0205	BHUPATHI HARIKA	P	P	P	P	P	P	P	P	P	P	P	P	P	P	P	P	P	P	P	P	P	P	P	P	P	P	P	P	P	P	P	P	P	P	
6	14E31A0210	ENTI VINAY KUMAR REDDY	P	P	P	P	P	P	P	P	P	P	P	P	P	P	P	P	P	P	P	P	P	P	P	P	P	P	P	P	P	P	P	P	P	P	
7	14E31A0211	K SHRAVYAN KUMAR	P	P	P	P	P	P	P	P	P	P	P	P	P	P	P	P	P	P	P	P	P	P	P	P	P	P	P	P	P	P	P	P	P	P	
8	14E31A0213	LOSIRLU SURESH KUMAR	P	P	P	P	P	P	P	P	P	P	P	P	P	P	P	P	P	P	P	P	P	P	P	P	P	P	P	P	P	P	P	P	P	P	P
9	14E31A0214	MACCHA SANDEEP	P	P	P	P	P	P	P	P	P	P	P	P	P	P	P	P	P	P	P	P	P	P	P	P	P	P	P	P	P	P	P	P	P	P	P
10	14E31A0215	MALLOJU MADHU	P	P	P	P	P	P	P	P	P	P	P	P	P	P	P	P	P	P	P	P	P	P	P	P	P	P	P	P	P	P	P	P	P	P	P
11	14E31A0216	MIR ABDUL KAREEM KHAN	P	P	P	P	P	P	P	P	P	P	P	P	P	P	P	P	P	P	P	P	P	P	P	P	P	P	P	P	P	P	P	P	P	P	P
12	14E31A0217	MOHAMMED ABDUL YAKUB	P	P	P	P	P	P	P	P	P	P	P	P	P	P	P	P	P	P	P	P	P	P	P	P	P	P	P	P	P	P	P	P	P	P	P
13	14E31A0218	MOHAMMED ABRAR	P	P	P	P	P	P	P	P	P	P	P	P	P	P	P	P	P	P	P	P	P	P	P	P	P	P	P	P	P	P	P	P	P	P	P
14	14E31A0219	MOHAMMED YAKUB PASHA	P	P	P	P	P	P	P	P	P	P	P	P	P	P	P	P	P	P	P	P	P	P	P	P	P	P	P	P	P	P	P	P	P	P	P
15	14E31A0220	PUVVADA SHAILENDRA	P	P	P	P	P	P	P	P	P	P	P	P	P	P	P	P	P	P	P	P	P	P	P	P	P	P	P	P	P	P	P	P	P	P	P
16	14E31A0221	RISHAV VERMA	P	P	P	P	P	P	P	P	P	P	P	P	P	P	P	P	P	P	P	P	P	P	P	P	P	P	P	P	P	P	P	P	P	P	P
17	14E31A0222	S POOJA	P	P	P	P	P	P	P	P	P	P	P	P	P	P	P	P	P	P	P	P	P	P	P	P	P	P	P	P	P	P	P	P	P	P	P
18	14E31A0223	SAPAVATH ANITHA	P	P	P	P	P	P	P	P	P	P	P	P	P	P	P	P	P	P	P	P	P	P	P	P	P	P	P	P	P	P	P	P	P	P	P

19	14E31A0224	SOMANABOINA RAGHU	P	P	P	P	P	P	P	P	P	P	P	P	P	P	P	P	P	P	P	P	P	P	P	P	P	P	P	P	P	P	P	P	P	P	
20	14E31A0225	SRIRAM BALA GOUD	P	P	P	P	P	P	P	P	P	P	P	P	P	P	P	P	P	P	P	P	P	P	P	P	P	P	P	P	P	P	P	P	P	P	P
21	14E31A0226	SUTHARI MANOJ KUMAR	P	P	P	P	P	P	P	P	P	P	P	P	P	P	P	P	P	P	P	P	P	P	P	P	P	P	P	P	P	P	P	P	P	P	P
22	14E31A0227	TALLURI GRESHMA CHOW	P	P	P	P	P	P	P	P	P	P	P	P	P	P	P	P	P	P	P	P	P	P	P	P	P	P	P	P	P	P	P	P	P	P	P
23	14E31A0228	VARUKOLU SHEKHAR	P	P	P	P	P	P	P	P	P	P	P	P	P	P	P	P	P	P	P	P	P	P	P	P	P	P	P	P	P	P	P	P	P	P	P
24	15E35A0201	AGUMAMIDI SAIRAM	P	P	P	P	P	P	P	P	P	P	P	P	P	P	P	P	P	P	P	P	P	P	P	P	P	P	P	P	P	P	P	P	P	P	P
25	15E35A0202	BASAKONDA BHOOMESH	P	P	P	P	P	P	P	P	P	P	P	P	P	P	P	P	P	P	P	P	P	P	P	P	P	P	P	P	P	P	P	P	P	P	P
26	15E35A0204	DYAVANAPPELLI RAJKUMAR	P	P	P	P	P	P	P	P	P	P	P	P	P	P	P	P	P	P	P	P	P	P	P	P	P	P	P	P	P	P	P	P	P	P	P
27	15E35A0205	GUNDAGANI MAHESH	P	P	P	P	P	P	P	P	P	P	P	P	P	P	P	P	P	P	P	P	P	P	P	P	P	P	P	P	P	P	P	P	P	P	P
28	15E35A0206	JAKKAWAR VIJAY	P	P	P	P	P	P	P	P	P	P	P	P	P	P	P	P	P	P	P	P	P	P	P	P	P	P	P	P	P	P	P	P	P	P	P
29	15E35A0207	KATTA SAIKRISHNA	P	P	P	P	P	P	P	P	P	P	P	P	P	P	P	P	P	P	P	P	P	P	P	P	P	P	P	P	P	P	P	P	P	P	P
30	15E35A0208	TANVEER KHAN	P	P	P	P	P	P	P	P	P	P	P	P	P	P	P	P	P	P	P	P	P	P	P	P	P	P	P	P	P	P	P	P	P	P	P
31	15E35A0209	TEKKAM HARISH	P	P	P	P	P	P	P	P	P	P	P	P	P	P	P	P	P	P	P	P	P	P	P	P	P	P	P	P	P	P	P	P	P	P	P
32	13E31A0215	GADDAM RAKESH	P	P	P	P	P	P	P	P	P	P	P	P	P	P	P	P	P	P	P	P	P	P	P	P	P	P	P	P	P	P	P	P	P	P	P
		Signature of the Faculty																																			

R. Venkath

Professor & Head

Dept. of Electrical & Electronics E.
 Acharya Institute of Science & Techno.
 Wvasapur, Bandlaguda, Keshavnagar,
 Hyderabad - 500 005.

MAHAVEER INSTITUTE OF SCIENCE AND TECHNOLOGY

(Affiliated to JNTUH, Hyderabad and Approved by AICTE, New Delhi)
Vyasapuri, Bandlaguda, Post: Keshavagiri, Hyderabad- 500005



organized by
Department of Electrical and Electronics Engineering

CERTIFICATE

This is certify that **Madugula Sai baba** bearing Hall Ticket No **14E35A020**
B.Tech Third Year has Participated in **Importancy of Earthing Training**
Program From **07-02-2017** to **20-02-2017** organized by **Department of**
Electrical and Electronics Engineering.

HOD
Dr.R.V.Amarnath

Dr.M.Rajendar Reddy
VITS

PRINCIPAL
Dr.K.S.S.S.N.R

PRINCIPAL
MAHAVEER INSTITUTE OF SCIENCE AND TECHNOLOGY
VYASAPURI, BANDLAGUDA, HYDERABAD - 500005

Vysapuri, Bandlaguda Post, Keshavnagar,

MAHAVEER



Hyderabad-500 005, TELANGANA INDIA

Tel: 040-64596979, 8978380692 Fax: 040-24455903

E-mail: e3hod_eee@gmail.com,

Website: www.mist.ac.in.

Approved by AICTE Affiliated to JNTUH Hyd

DEPARTMENT OF ELECTRICAL & ELECTRONICS

Date: 0-08-2016

To
The Principal,
Mist,
Hyderabad,

Sub-Proposal for Add on course-Reg.

Respected sir,

We are going to conduct two weeks workshop on **MULTISIM Programming**. We require your approval to go head for further proceeding and hope to get an opportunity to serve you the best.

With thanks and regards

R. V. Amal

HOD-EEE

Professor & HOD

Dept. of Electrical & Electronics Engg
Mahaveer Institute of Science & Technology

Vysapuri, Bandlaguda, Keshavnagar

Hyderabad-500 005.

[Handwritten Signature]

PRINCIPAL
MAHAVEER
INSTITUTE OF SCIENCE & TECHNOLOGY
Bandlaguda, Hyderabad-500 005.

Vysapuri Bandlaguda Post: Keshavgiri.

MAHAVEER



Hyderabad-500 005, TELANGANA INDIA
Tel: 040-64596979, 8978380692 Fax: 040-24455003
E-mail: e3hod.eee@gmail.com,
Website: www.mist.ac.in.

Approved by AICTE. Affiliated to JNTUH, Hyd

DEPARTMENT OF ELECTRICAL & ELECTRONICS

Date 009-08-2016

CIRCULAR

Technical Trainings for II B Tech students are starting from **16-08-2016** onwards. All HODs and placements coordinators have to manage the trainings and ensure 95% attendance all through the sessions.

All mentors need to send the compiled feedback report to HOD at e3hod.eee@gmail.com daily. Mentors are advised to take care of PNR (Students not participating in training).

Agenda: **Multisim Program**

Design & Development of Curriculum for Add on Courses Faculty names: Dr RV AMARNATH

2 G Prem kumar reddy

PRINCIPAL
MAHAVEER
INSTITUTE OF SCIENCE & TECHNOLOGY
Bandlaguda, Hyd-500 005.

R.V. Amarnath
HOD-EEE

Professor & Head
Dept. of Electrical & Electronics Engg
Mahaveer Institute of Science & Technology,
Vysapuri, Bandlaguda, Keshavgiri,
Hyderabad - 500 005.

Vysapuri, Bandlaguda Post:Keshavgiiri,

MAHAVEER



Hyderabad-500 005, TELANGANA INDIA

Tel: 040-64596979,8978380692 Fax: 040-24455903

E-mail: pjhod_eee@gmail.com,

Website: www.mist.ac.in.

Approved by AICTE Affiliated to JNTUH Hyd

DEPARTMENT OF ELECTRICAL & ELECTRONICS

SYLLABUS FOR Multisim Program

SNO	TOPIC COVERED	DURATION
1	Introduction	3
2	Concept of multisim	3
3	Feature of multisim	3
4	commands of simulating software (MULTISIM) circuit.	3
5	Simulate of various combinational circuits.	3
6	Series and parallel circuit of resistor Building a Business Case	3
7	inductor, capacitor and its combination in ac circuits	3
8	Half wave, full wave and bridge	3
9	power amplifier and oscillator	3
10	Measurement of voltage and current in various electrical	3

R.V Amaraiah
HOD-EEE

Principal

Dept. of Electrical & Electronics Engg.
Mahaveer Institute of Science & Technology
Vysapuri, Bandlaguda, Keshavgiiri,
Hyderabad - 500 005.

R.V Amaraiah
PRINCIPAL
MAHAVEER
INSTITUTE OF SCIENCE & TECHNOLOGY
Bandlaguda, Hyd-500-005.

Vysapuri, Bandlaguda Post, Keshavnagar,

MAHAVEER



Hyderabad 500 005, TELANGANA INDIA

Tel: 040-64596979, 8978380692 Fax: 040-24455003

E-mail: e3hod.eee@gmail.com

Website: www.mist.ac.in

Approved by AICTE. Affiliated to JNTUH Hyd

DEPARTMENT OF ELECTRICAL & ELECTRONICS

LIST OF REGISTERED STUDENTS FOR Multisim Program

SNO	HALL TICKET NO	NAME OF THE STUDENT
1	15E31A0201	ADARI UMASHANKAR
2	15E31A0203	ARRUM VAMSHIKRISHNA
3	15E31A0205	B AKHILA
4	15E31A0206	BALLE ARAVIND KUMAR
5	15E31A0207	BANOOTH BALAJI
6	15E31A0208	BHUKYA PRAVALIKA
7	15E31A0209	BURRA HARISH
8	15E31A0210	CHEVITI VINAY KUMAR
9	15E31A0211	GANDU SAI KIRAN
10	15E31A0213	GLUDA AVINASH
11	15E31A0216	KASIREDDY SAI KIRAN REDDY
12	15E31A0217	KATAKAM ANUDEEP KUMAR
13	15E31A0218	KAVYAN
14	15E31A0219	KADAPATI SURESH
15	15E31A0220	KORUSAR SURESH KISHOR
16	15E31A0221	KUCHIBOR PRANEE THEDEEP REDDY
17	15E31A0222	KUSUNOJU MADHU
18	15E31A0224	NADDIPALLI KANCHANA
19	15E31A0225	NAKIDI ABHISHEK
20	15E31A0226	NERLAKANTI NANDUWARDHAN REDDY

PRINCIPAL
MAHAVEER
INSTITUTE OF TECHNOLOGY
HYD-005

**DEPARTMENT OF ELECTRICAL & ELECTRONICS**

21	15E31A0227	RAIHOD AMBADAS
22	15E31A0228	SHIVANNAGARI BHASKARREDDY
23	15E31A0229	SILUSANI NAVYASRI
24	15E31A0230	SODI SRIKRISHNA
25	15E31A0231	THONGALA SHINEY
26	15E31A0232	VOGULAPU RAJESH
27	15E31A0233	YARUKALA SAI PRAKASH
28	15E31A0234	J RAVI TEJA
29	16E35A0201	ALLE H NISHITA
30	16E35A0202	ERRALLA DEEPAK
31	16E35A0203	JAKANAPALLY SHIRISHA
32	16E35A0204	JALLA ANJANEYULU
33	16E35A0205	KRISHNATEJA ALLE H
34	16E35A0206	KRISHNATEJA ALLE H
35	16E35A0207	PURENARSENA
36	16E35A0208	RAVULA PAVAN KUMAR
37	16E35A0209	SURYA SRAVANTHI
38	16E35A0210	VANGALA RANLETH KUMAR
39	16E35A0211	YALAGANDULA DURGA DEVI

PRINCIPAL
MAHAVEER

Department of Electrical & Electronics Engineering
Institute of Science & Technology

Vysapuri, Bandlaguda, Hyderabad - 500 005.

R.V. Murali

Professor & Head

Department of Electrical & Electronics Engineering
Institute of Science & Technology
Vysapuri, Bandlaguda, Keshavnagar,
Hyderabad - 500 005.

Vysapuri, Bandlaguda Post:Keshavgiri,

MAHAVEER



Hyderabad-500 005, TELANGANA INDIA

Tel: 040-64596979,8978380692 Fax: 040-24455903

E-mail: e3hod.eee@gmail.com,

Website: www.mist.ac.in,

Approved by AICTE Affiliated to JNTUH Hyd

DEPARTMENT OF ELECTRICAL & ELECTRONICS

Multisim Program QUESTION PAPER

Duration: 120 Minutes

4 X5 = 20 Marks

Answer the following all questions. Each question carries 5 marks.

1. How to resolve the issue in desmond ?
2. Explain the concept of multisim for coupled inductor dc-dc converter ?
3. Explain features included in multisim?
4. How to design control feedback loop to control duty cycle for voltage regulation of ac- dc conveter?

Keshav

PRINCIPAL
MAHAVEER
INSTITUTE OF SCIENCE & TECHNOLOGY
Bandlaguda, Hyderabad

R.V. Amruth
HOD-EEE

Dept. of Electrical & Electronics Engineering
Mahaveer Institute of Science & Technology
Vysapuri, Bandlaguda, Keshavnagar,
Hyderabad - 500 005.

Vysapuri, Bandlaguda Post, Keshavnagar,

MAHAVEER



Hyderabad-500 005, TELANGANA INDIA

Tel: 040-64596979, 8978380692 Fax: 040-24455003

E-mail: e3hod.eee@gmail.com,

Website: www.mist.ac.in,

Approved by AICTE. Affiliated to JNTUH, Hyd

DEPARTMENT OF ELECTRICAL & ELECTRONICS

RESULT SHEET FOR Multicim Program REGISTERED STUDENTS

SNO	ROLL TICKET NO	NAME OF THE STUDENT	MARKS (100)	RESULT
1	15E31A0201	ADARI UMASHANKAR	70	PASS
2	15E31A0203	ARRUM VAMSHIKRISHNA	10	PASS
3	15E31A0205	B AKHILA	70	PASS
4	15E31A0206	BALLE ARAVIND KUMAR	10	PASS
5	15E31A0207	BANOTH BALAJI	70	PASS
6	15E31A0208	BHUKYA PRAVALIKA	70	PASS
7	15E31A0209	BURRA HARISH	10	PASS
8	15E31A0210	CHEVITH VINAY KUMAR	70	PASS
9	15E31A0211	GANDI SAIKIRAN	10	PASS
10	15E31A0213	GUDA AVINASHI	70	PASS
11	15E31A0216	KASIREDDY SAI KIRAN REDDY	70	PASS
12	15E31A0217	KATAKAM ANUDEEP KUMAR	10	PASS
13	15E31A0218	KAVYA N	70	PASS
14	15E31A0219	KOKKULA SAIKIRAN	70	PASS
15	15E31A0220	KOONARAPU AKHIL	17	PASS
16	15E31A0221	KUCHOOR PRANEETHDEEP REDDY	70	PASS
17	15E31A0222	15E31A0222	70	PASS
18	15E31A0224	NADDIPATI KRANVIJAYA	70	PASS
19	15E31A0225	NAKIDI ABHISHEK	70	PASS
20	15E31A0226	NERI AKANHI NANDU ARDHAN REDDY	70	PASS
21	15E31A0227	RATHOD AMBADAS	10	PASS
22	15E31A0228	SHIVANNAGARI BHASKARREDDY	70	PASS
23	15E31A0229	SILUSANI NAVYASRI	19	PASS
24	15E31A0230	SODI SRIKRISHNA	70	PASS
25	15E31A0231	THONGALA SHINEY	10	PASS

K. Srinivas

PRINCIPAL
MAHAVEER
15/11/2015

Vysapuri, Bandlaguda Post: Keshavpuri,

MAHAVEER



Hyderabad-500 005, TELANGANA INDIA
Tel: 040-64596979, 8978380692 Fax: 040-24455003
E-mail: e3hod.eee@gmail.com,
Website: www.mistlac.in.

Approved by AICTE, Affiliated to JNTU(H) Hyd

DEPARTMENT OF ELECTRICAL & ELECTRONICS

26	15E31A0232	VOGULAPU RAJESH	20	PASS
27	15E31A0233	YARUKALA SAI PRAKASH	20	PASS
28	15E31A0234	JRAVI TEJA	16	PASS
29	16E35A0201	ALE TI NISHILA	20	PASS
30	16E35A0202	ERRALLA DEEPAK	20	PASS
31	16E35A0203	JAKANAPALLY SHIRISHA	20	PASS
32	16E35A0204	JALLA ANJANEYULU	18	PASS
33	16E35A0205	KRISHNATEJA ALE TI	19	PASS
34	16E35A0206	PEDDA GOLLA SHIRISHA YADAV	18	PASS
35	16E35A0207	PURI NARSING	17	PASS
36	16E35A0208	RAVULA PAVAN KUMAR	19	PASS
37	16E35A0209	SURYA SRIVANSHI	19	PASS
38	16E35A0210	VANGALA RANEETHI KUMAR	19	PASS
39	16E35A0211	YALAGANDULA DURGA DEVI	19	PASS

No. of students Registered: 39

No. of students Passed: 39

No. of students failed: NIL

PRINCIPAL
MAHAVEER
VIT of SCIENCE & TECHNOLOGY
Bandlaguda, Hyd-500 005.

R.V. Ananth

Professor in Charge
Dept. of Electrical & Electronics Engg
Mahaveer Institute of Science & Technology
Keshavpuri, Bandlaguda, Keshavpuri,
Hyderabad - 500 005.

Vysapuri, Bandlaguda Post Keshavgiri,

MAHAVEER



Hyderabad-500 005, TELANGANA INDIA

Tel: 040-64596979,8978380692 Fax: 040-24455003

E-mail: e3hod.eee@gmail.com

Website: www.mist.ac.in

Approved by AICTE Affiliated to JNTUH Hyd

DEPARTMENT OF ELECTRICAL & ELECTRONICS

SUMMARY REPORT OF Multisim Program

Objective: In the fast growing electrical field for understanding of installation of machinery, operation of any equipment, to do maintenance of any equipment and wiring of panel or buildings, knowledge of drawing reading and drawing making is required. For better understanding of various electrical circuit and working of components, knowledge of simulation software is required. Learning of software like CAD, PSIM and MULTISIM will enhance student's ability for working in this fast growing electrical market

COORDINATOR

Copy to

1. Department Notice Board
2. Principal for Information
3. Committee Members (Academic)



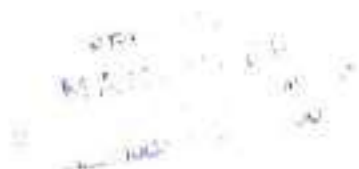

Two week certificate course

011

Multisim programme

16th August–1st September, 2016)

Timings: 09.30 am to 11.30 am



Organized by



Dept. of Electrical & Electronics Engineering

Mahaaveer Institute of Science & Technology

Vyasapuri, Bandlaguda, Hyderabad 500005.

(Affiliated to JNTUH)

About the College

As an Institute committed to quality education **MIST** aims at providing learning with a technology edge. Right from its inception in **2001**, it has turning itself to meet this objective. It endeavors to provide consistent training to the students to help them evolve as competent professionals in the highly competitive world.

About the Department

The Department of **Electrical & Electronics Engineering** was established in **2001** which offers **B.Tech, and M.Tech (POWER Engineering and Energy Systems)** courses with highly qualified, dedicated and motivated faculty. The courses and programmes offered by the department not only impart technical expertise to the students but also gives a professional experience.

Organizing committee

Chief Patron

Smt S Sudershan Reddy, Chairman, MIST

Sri S Surendar Reddy, Secretary, MIST

Sri S Dhananjay Reddy, Joint Secretary, MIST

Patron

Dr KSSSN Reddy, Principal, MIST

Convener

Dr R.V. Amarnath, Professor, HoD EEE Dept.

Co-convenor

Mr.G. Prem Kumar Reddy, Assoc. Prof., EEE Dept.

Program Coordinators

Mr.A.MAHEESH, Assistant Professor, EEE Dept.

Mr.G.Greeshma, Assistant Professor, EEE Dept.

Mrs.R.KALYANI, Assistant Professor, EEE Dept.

Mr. B.SATISH, Assistant Professor, EEE Dept.

Mr.T.Ravibabu, Assistant Professor, EEE Dept.

Mr.P.Phanindra, Assistant Professor, EEE Dept.

Mr.S.Suresh, Assistant Professor, EEE Dept.

Course Details

- Introduction
- Concept of multism
- Feature of multism
- commands of simulating software MULTSIM) circuit.
- Simulate of various combinational circuits
- Series and parallel circuit of resistor Building a Business Case
- inductor, capacitor and its combination in ac circuits

Resource Person

Mr.G.Srinivas

VITS

Objectives of Workshop

Objective: In the fast growing electrical field for understanding of installation of machinery, operation of any equipment, to do maintenance of any equipment and wiring of panel or buildings, knowledge of drawing, reading and drawing making is required. For better understanding of various electrical circuit and working of components, knowledge of simulation software is required. Learning of software like CAD, PSIM and MULTSIM will

MAHAVEER INSTITUTE OF SCIENCE AND TECHNOLOGY

(Affiliated to JNTUH, Hyderabad and Approved by AICTE, New Delhi)
Vyasapuri, Bandlaguda, Post: Keshavagiri, Hyderabad- 500005



organized by
Department of Electrical and Electronics Engineering

CERTIFICATE

This is certify that **K.Madhu** bearing Hall Ticket No **15E31A0222** of **B.T. Second Year** has Participated in **Multisim Programming Training Prog** From 16-08-2016 to 29-08-2016 organized by **Department of Electrical Electronics Engineering.**

HOD
Dr.R.V.Amarnath

G.Srinivas
VITS

PRINCIPAL
Dr.K.S.S.N.R

PRINCIPAL
MAHAVEER INSTITUTE OF SCIENCE AND TECHNOLOGY
BANDLAGUDA



MAHAVEER
INSTITUTE OF SCIENCE & TECHNOLOGY

Approved by AICTE, Affiliated to JNTU, Hyderabad.
Vasavuri, Bandlaguda, Post: Keshavnagar, Hyderabad-503005.

Organising committee

CHIEF PATRON

Sri.S.Sudershan Reddy

Chairman

Sri. S. Surendar Reddy

Secretary

Sri S. Dhanunjay Reddy

Joint Secretary

DIRECTOR

Dr. H. S. N. Murthy

PATRON

Dr.K.S.S.Reddy, Principal

CONVENER

Mr.G.K.Shanmukh Dev,

Asso.Prof,Dept. Of Mechanical

PROGRAM COORDINATORS

Mr.B.Venkateswar Reddy

K.Devi Singh

Conducted On

02/5/2016- 12/5/2016

About the College

As an Institute committed to quality education, MIST aims at providing learning with a Technology-edge. It endeavors to provide consistent training to its students to help them evolve as competent professionals in the highly competitive world. Right from its inception in 2001, it has been tuning itself to meet this objective. A new civilization is emerging in our lives. This civilization brings with it a new way of working. Millions are already tuning their lives to the rhythms of tomorrow.

About the Mechanical Department

The Mechanical engineering is one of the core engineering departments, which has potential to accommodate all efficient engineers. The Mechanical engineers serve all other branches of engineering directly or indirectly. The Mechanical engineers can find their place in Automobile engineering sector, Steel Plants, Power plants, Software industries, Manufacturing industries, Design industries, Military, Naval and Air force, Defense research organizations, Material research organizations etc.

About the Workshop

AutoCAD is globally used by surveyors, designers, engineers, drafters. Globally, AutoCAD has proven as an efficient and user-friendly Program. Program, Commercial drafting and computer-aided design(CAD) software applications are AutoCAD. AutoCAD software is recognized internationally for its remarkable editing capabilities, which make it likely to digitally draw building plans or recreate 3D images. AutoCAD is compatible with other applications like 3D Max. The designers can even import or export DWG & DXG Files to the application. Also, these files can even be exported from AutoCAD to other applications for creating more improved projects & presentations.



Two week
Certification Course
on

Auto CAD

Organized by

Department of Mechanical
Engineering

Vysaapuri, Bandipetguda Post, Keshavnagar,
Hyderabad-500 005, Telangana (INDIA)
Tel: 040-64596979, 20020773, Fax: 040-24455003
E-mail: principal.mahaveer@gmail.com
Website: www.mist.ac.in

MAHAVEER



Approved by AICTE, Affiliated to JNTU, Hyderabad.

Date: 30-04-2016

To
The Principal
MIST,
Hyderabad.

Sub: Proposal for Add-on Course-Reg.

Respected sir,

We are going to conduct 10 days Technical Training for II B. Tech students on "Introduction to Auto CAD". We require your approval to go head for proceeding and hope to get an opportunity to serve you the best.

With thanks and regards

G. K. Shanmukh Dev
G.K. SHANMUKH DEV

HOD

Department of Mechanical Engineering

Keshav

Principal
MIST
Hyderabad-500 005

Vysapuri, Bandlaguda Post:Keshavgiri,
Hyderabad-500 005, Telangana INDIA
Tel: 040-64596979,20020773, Fax: 040-24455003
E-mail: principal.mahaveer@gmail.com,
Website: www.mst.ac.in,

MAHAVEER
INSTITUTE OF SCIENCE & TECHNOLOGY
Approved by AICTE, Affiliated to JNTUH,Hyd.



Date: 30.04.2016

CIRCULAR

Technical Training for II B. Tech students are starting from 2nd MAY, 2020 onwards. All HODs and Placements coordinators have to manage the trainings and ensure 95% attendance all through the sessions.

All Mentors need to send the compiled feedback report to G.K.Shanmukh Dev, HOD at e3hod.mech@gmail.com daily.

Agenda: 1. Introduction to AUTOCAD.

Design and Development of curriculum for Add on course:

Name of the Faculty : B.VENKATESWAR REDDY

G.K. Shanmukh Dev
G.K.SHANMUKH DEV

HOD

Department of Mechanical Engineering

K. S. Reddy
PRINCIPAL
MAHAVEER
INSTITUTE OF SCIENCE & TECHNOLOGY
Bandlaguda, Hyd-500 005.



Auto CAD SYLLABUS

1: Getting Started with AutoCAD

- Opening and Creating Drawings
- Exploring the AutoCAD interface
- Zooming and Panning

2: Basic Drawing & Editing Commands

- Using the Mouse, Keyboard, and Enter Key to work quickly and efficiently in AutoCAD
- Lines
- Circles
- Rectangles

3: Projects - Creating a Simple Drawing

- Creating Simple Drawings
- Using Object Snap Tracking to extrapolate a projected top view
- Using Modify tools to arrange an office layout

4: Drawing Precision in AutoCAD

- Polar and Ortho Tracking
- Entering Coordinates and Angles
- Object Snaps and Tracking

5: Making Changes in Your Drawing

- Move
- Copy
- Rotate
- Mirror
- Scale
- Using the reference option with the Scale Tool

7: Organizing Your Drawing with Layers

- Layer States
- Properties by Layer
- Layer Tools

8: Advanced Object Types

- Polylines

[Handwritten signature]



- Polygons
- Arcs
- Ellipses

9: Advanced Editing Commands

- Trim and Extend
- Fillet and Chamfer
- Polyline Edit and Spline
- Offset and Explode
- Join

10: Inserting Blocks

- The Insert Block Command
- Inserting Blocks with Tool Palettes
- Dynamic Blocs
- Migrating Blocks and other Elements between Drawings with Design Center

11: Text

- The Multiline Text Tool
- The Single Line Text Tool
- Editing Text
- Text in Model Space vs. Paper Space
- The Multileader Tool

12: Hatching

- The Hatch Command
- The Hatch Editor Ribbon Tab
- Saving and Applying Hatches with Tool Palettes

13: Adding Dimensions

- Using Dimensioning Tools
- Dimensioning in a Layout Tab vs. the Model Tab
- Using Dimension Styles
- Editing Dimensions

14: Projects - Annotating Your Drawing

- Dimensioning a Mechanical Drawing



Department of Mechanical Engineering Auto CAD Technical Training student attendance list 2016-17

SL.NO.	ROLL NO.	NAME OF THE STUDENT	YEAR
1	15E31A0301	ABDUL ABRAR	II
2	15E31A0302	ABDUL RAHMAN	II
3	15E31A0303	ANAND KUMAR	II
4	15E31A0304	AQUEEB UDDIN FIRDUSH	II
5	15E31A0305	ATTLURI SURESH REDDY	II
6	15E31A0306	BANDA SATYA SHIVA REDDY	II
7	15E31A0310	BHOOMENI NARENDHAR	II
8	15E31A0311	BICHKUNDA SUNIL KUMAR	II
9	15E31A0313	CHIDIRALA RAJKUMAR	II
10	15E31A0315	DESHAGOUNI MOHAN SAI	II
11	15E31A0317	GURRALA VENKATA NARSI REDDY	II
12	15E31A0318	HUSSAIN FAIZ ULLAH	II
13	15E31A0319	K SAMPATH	II
14	15E31A0320	KASIREDDY SAIMANOJ REDDY	II
15	15E31A0321	KATTA SRIKANTH REDDY	II
16	15E31A0322	KESHETTI NIKHIL	II
17	15E31A0325	M A LATEEF	II
18	15E31A0327	MANCHIKANTI ARAVIND REDDY	II
19	15E31A0329	MD UBED UL RAHMAN	II
20	15E31A0331	MOHAMMED ABDULLAH ZUBAIR	II
21	15E31A0332	MOHAMMED AJAZ	II
22	15E31A0333	MOHAMMED ISMAIL FURQAN	II

[Handwritten signature]

Vysapuri, Bandlaguda Post Keshavnagar,
Hyderabad-500 005, Telangana INDIA
Tel: 040-64596979, 20020773, Fax: 040-24455003
E-mail: principal.mahaveer@gmail.com
Website: www.mist.ac.in

MAHAVEER



Approved by AICTE, Affiliated to JNTU(Hyd)

23	15E31A0334	MOHD ABDUL ATIF	II
24	15E31A0336	MOHD ASIM KHAN	II
25	15E31A0337	MOHD FARHAN AHMED SHAREEF	II
26	15E31A0338	MOHD SALA UDDIN	II
27	15E31A0340	MOHD TALHA	II
28	15E31A0341	MUDAVATH SRINIVAS	II
29	15E31A0342	NELLURI AJAY KUMAR	II
30	15E31A0343	PADAMATINTI AVINASH	II
31	15E31A0344	PALNATI SRIKANTH REDDY	II
32	15E31A0346	POLAKA PARDHA SARADHI REDDY	II
33	15E31A0349	SABHAVAT SEVYA	II
34	15E31A0350	SHADMAN ASHRAF	II
35	15E31A0351	SHAIK ABDUL SAIF	II
36	15E31A0352	SHAIK ARIF HUSSAIN	II
37	15E31A0354	SOHAIL MOHAMMED MASOOD AHMED KHAN	II
38	15E31A0356	SYED BAHAUDDIN	II
39	15E31A0360	SYED QAMAR UDDIN RAZA SHAH QUADRI	II
40	15E31A0361	SYED SHAHED AHMED	II
41	15E31A0362	T KULDEEP SINGH	II
42	15E31A0363	TANNEERU RAJA	II
43	15E31A0365	VANGAPALLY SRINIVAS	II
44	16E35A0301	AMAR BIRADAR	II
45	16E35A0302	BHUKYA RAMA	II
46	16E35A0303	DHARAVATH RAVINDER NAYAK	II

Principal
Mahaveer Institute of Technology
Hyderabad-500 005

Vysapuri, Bandlaguda Post Keshavnagar,
Hyderabad-500 005, Telangana INDIA
Tel: 040-64896979, 20020773, Fax: 040-24450003
E-mail: principal.mahaveer@gmail.com
Website: www.mist.ac.in

MAHAVEER



Approved by AICTE, Affiliated to JNTU(Hyd)

47	16E35A0304	EROJI SURESH	II
48	16E35A0305	GOURAV KUMAR JHA	II
49	16E35A0306	KALIKOTA SAI CHARAN	II
50	16E35A0307	MANYALA SAITEJA	II
51	16E35A0308	TADEM BHARATH KUMAR	II
52	16E35A0310	TANGELLA ASHOKA VARDHAN RAJU	II
53	14E31A0303	ANSAR AHMED KHAN	II
54	14E31A0334	MOHAMMED ABRAR AHMED	II
55	14E31A0335	MOHAMMED AKIF AHMED	II
56	14E31A0373	G KARTHIK RAJ	II
57	14E31A0374	A KAUSHIK VILAS	II
58	14E31A0386	MOHAMMED SOHAIB	II
59	14E31A0397	SYED SIKANDER ALI	II
60	14E31A0398	SYED VIKAYAT ULLAH	II
61	15E35A0301	E MADIUKAR	II
62	13E31A0304	AKASH HANVETH	II
63	14E31A0390	RAHUL SINGH	II
64	14E31A0376	IMAMID HASAN KHAN	II
65	14E31A0359	TAMMARASHI AJAY KUMAR	II
66	13E31A0350	S KUNAL	II
67	14E31A0341	MOHD KHAHA MOHIUDDIN	II
68	14E31A0352	SAIFULLAH EKMAN JALKOTE	II
69	14E31A0337	MOHD ADNAN AZHAR	II
70	14E31A0339	MOHD ABDUL HAMEED GOURI	II

K. S. S.
PRINCIPAL
2020



Technical Training Exam on Auto CAD Software (A.Y-2016-17)

2x10=20 Marks

Answer All the Questions

1. Draw the given 2D model into 3D model by using AutoCad

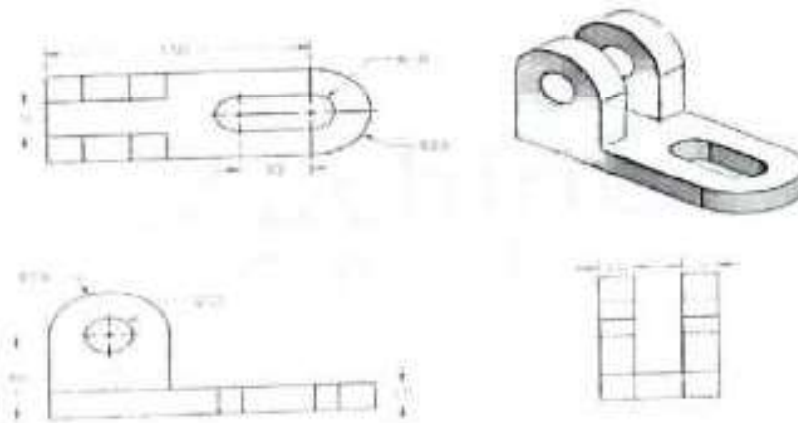

2. Draw the given 2D model into 3D model by using Auto CAD.

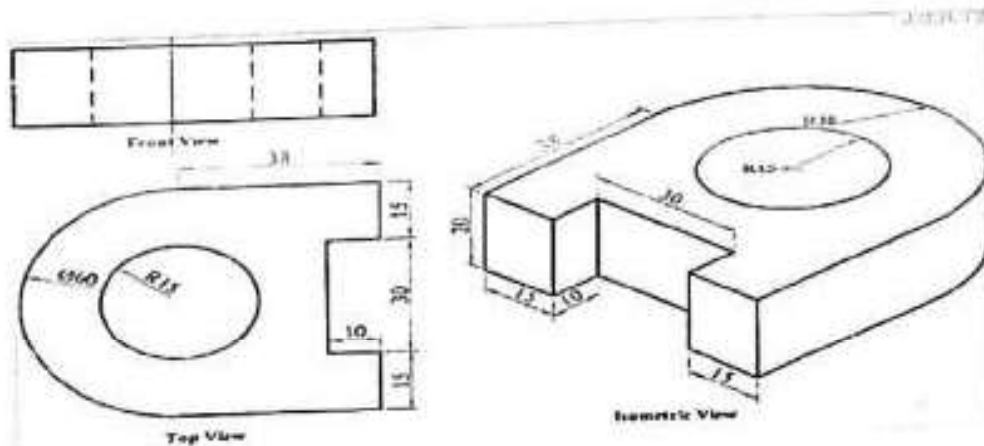

Vysapuri, Bandlaguda Post, Keshavnagar,
Hyderabad-500 005, Telangana, INDIA
Tel: 048-64596379, 20020773, Fax: 040-24455003
E-mail: principal.mahaveer@gmail.com
Website: www.mst.ac.in

MAHAVEER



Approved by AICTE, Affiliated to JNTU(Hydr)

Department of Mechanical Engineering
Auto CAD Technical Training student Marks list 2016-17

S.NO	Roll No	Name of the student	YEAR	MARKS	PASS/FAIL
1	15E31A0301	ABDUL ABRAR	II	16	PASS
2	15E31A0302	ABDUL RAHMAN	II	16	PASS
3	15E31A0303	ANAND KUMAR	II	12	PASS
4	15E31A0304	AQUEEB UDDIN FIRDUSH	II	12	PASS
5	15E31A0305	ATTLURI SURESH REDDY	II	16	PASS
6	15E31A0306	BANDA SATYA SHIVA REDDY	II	16	PASS
7	15E31A0310	BHOOMENI NARENDHAR	II	16	PASS
8	15E31A0311	BICKKUNDA SUNIL KUMAR	II	16	PASS
9	15E31A0313	CHIDIRALA RAJKUMAR	II	16	PASS
10	15E31A0315	DESHAGOUNI MOHAN SAI	II	16	PASS
11	15E31A0317	GURRALA VENKATA NARSI REDDY	II	16	PASS
12	15E31A0318	HUSSAIN FAIZ ULLAH	II	16	PASS
13	15E31A0319	K SAMPATH	II	16	PASS
14	15E31A0320	KASIREDDY SAIMANOJ REDDY	II	16	PASS
15	15E31A0321	KATTA SRIKANTH REDDY	II	16	PASS
16	15E31A0322	KESHETTI NIKHIL	II	16	PASS
17	15E31A0325	M A LATEEF	II	16	PASS
18	15E31A0327	MANCHIKANTI ARAVIND REDDY	II	16	PASS
19	15E31A0329	MD UBED UL RAHMAN	II	15	PASS
20	15E31A0331	MOHAMMED ABDULLAH ZUBAIR	II	16	PASS
21	15E31A0332	MOHAMMED AJAZ	II	16	PASS
22	15E31A0333	MOHAMMED ISMAIL FURQAN	II	15	PASS
23	15E31A0334	MOHD ABDUL ATIF	II	16	PASS

Keshi
MAHAVEER
Principal
Bandlaguda, Hyderabad-500 005.

Vysapur, Bandlaguda Post Keshavnagar,
Hyderabad 500 025, Telangana INDIA
Tel: 040-64596979, 20020773, Fax: 040-24455003
E-mail: principal.mahaveer@gmail.com
Website: www.mahaveer.ac.in

MAHAVEER



Approved by AICTE, Affiliated to JNTUH Hyd

24	15E31A0336	MOHD ASIM KHAN	II	14	PASS
25	15E31A0337	MOHD FARHAN AHMED SHAREEF	II	15	PASS
26	15E31A0338	MOHD SALA UDDIN	II	15	PASS
27	15E31A0340	MOHD TALHA	II	16	PASS
28	15E31A0341	MUDAVATH SRINIVAS	II	14	PASS
29	15E31A0342	NELLURI AJAY KUMAR	II	16	PASS
30	15E31A0343	PADAMATINTI AVINASH	II	15	PASS
31	15E31A0344	PALNATI SRIKANTH REDDY	II	14	PASS
32	15E31A0346	POLAKA PARDHA SARADHI REDDY	II	18	PASS
33	15E31A0349	SABHAVAT SEVYA	II	15	PASS
34	15E31A0350	SHADMAN ASHRAF	II	16	PASS
35	15E31A0351	SHAIK ABDUL SAIF	II	15	PASS
36	15E31A0352	SHAIK ARIF HUSSAIN	II	16	PASS
37	15E31A0354	SOHAIL MOHAMMED MASOOD AHMED KHAN	II	16	PASS
38	15E31A0356	SYED BHAUDDIN	II	15	PASS
39	15E31A0360	SYED QAMAR UDDIN RAZA SHAH QUADRI	II	16	PASS
40	15E31A0361	SYED SHAHED AHMED	II	16	PASS
41	15E31A0362	T KULDEEP SINGH	II	15	PASS
42	15E31A0363	TANNEERU RAJA	II	16	PASS
43	15E31A0365	VANGAPALLY SRINIVAS	II	14	PASS
44	16E35A0301	AMAR BIRADAR	II	15	PASS
45	16E35A0302	BHUKYA RAMA	II	15	PASS
46	16E35A0303	DHARAVATH RAVINDER NAYAK	II	16	PASS
47	16E35A0304	EROJI SURESH	II	14	PASS
48	16E35A0305	GOURAV KUMAR JHA	II	16	PASS

Mahaveer
MAHAVEER
INSTITUTE OF TECHNOLOGY
Bandlaguda Post - 500 025

Vysapur, Bandlaguda Post, Keshavnagar,
Hyderabad 500 005, Telangana INDIA
Tel: 040-64596979, 20020773, Fax: 040-24405003
E-mail: principal.mahaveer@gmail.com
Website: www.mist.ac.in

MAHAVEER



Approved by AICTE, Affiliated to JNTU Hyd

49	16E35A0306	KALIKOTA SAI CHARAN	II	15	PASS
50	16E35A0307	MANYALA SAHEJA	II	14	PASS
51	16E35A0308	TADEM BHARATH KUMAR	II	18	PASS
52	16E35A0310	TANGELLA ASHOKA VARDHAN RAJU	II	15	PASS
53	14E31A0303	ANSAR AHMED KHAN	II	16	PASS
54	14E31A0334	MOHAMMED ABRAR AHMED	II	15	PASS
55	14E31A0335	MOHAMMED AKIF AHMED	II	15	PASS
56	14E31A0373	G KARTHIK RAJ	II	18	PASS
57	14E31A0374	A KAUSHIK VILAS	II	15	PASS
58	14E31A0386	MOHAMMED SOHAIB	II	16	PASS
59	14E31A0397	SYED SIKANDER ALI	II	15	PASS
60	14E31A0398	SYED VIKAYAT ULLAH	II	16	PASS
61	15E35A0301	E MADHUKAR	II	15	PASS
62	13E31A0304	AKASH HANVETHI	II	16	PASS
63	14E31A0390	RAHUL SINGH	II	15	PASS
64	14E31A0376	IMAMD HASAN KHAN	II	14	PASS
65	14E31A0359	TAMMARASHI AJAY KUMAR	II	18	PASS
66	13E31A0350	S KUNAL	II	15	PASS
67	14E31A0341	MOHD KHANNA MOHIDDIN	II	16	PASS
68	14E31A0352	SAIFULLAH EKMAN JALKOTE	II	16	PASS
69	14E31A0337	MOHD ADNAN AZHAR	II	15	PASS
70	14E31A0339	MOHD ABDUL HAMEED GOURI	II	14	PASS

Vysapuri, Bandlaguda Post, Keshavnagar,
Hyderabad-500 066, Telangana (India)
Tel: 040-64596975, 20020173, Fax: 040-24455003
E-mail: principal.mahaveer@gmail.com,
Website: www.mst.ac.in

MAHAVEER



Approved by AICTE, Affiliated to JNTUHHyd

Auto CAD COURSE
Summary

Department of Mechanical Engineering

- Use AutoCAD for daily working process.
- Navigate throughout AutoCAD using major navigating tools.
- Understand the concept and techniques to draw.
- Create multiple designs using several of tools.
- Create layers to control the objects' visibility.
- Explain drawing using annotations.
- Plot or print the drawing by scale.
- To use constraint for certain design.

Copy to :

1. Department of Notice Board
2. Principal for Information
3. Committe Members(Academic)

Kshatris

PT. PRINCIPAL
10/10/2015
10/10/2015
10/10/2015

Vysapur, Bandlaguda Post Keshavnagar,
Hyderabad-500 055, Telangana INDIA
Tel: 040-64596979, 23020773, Fax: 040-24455003
E-mail: principal.mahaveer@gmail.com
Website: www.mia.ac.in

MAHAVEER



Approved by AICTE, Affiliated to JNTU(Hyd)

CERTIFICATE OF COURSE COMPLETION

This certificate is presented to Syed Bahauddin of MIST,
who has successfully completed technical training course on "Auto
CAD" held from 02-05-2016 to 12-05-2016 and found the
student performance to be excellent.



ESTD : 2001

G.K. Shanmukh Dev
G.K. SHANMUKH DEV

HOD

Department of Mechanical Engineering

K. Srinivas

Principal
Mahaveer Institute of Science & Technology
Bandlaguda Post, Hyderabad - 500 055

Vyasapuri, Bandlaguda Post, Kothuramreddy,
Hyderabad-500 005, Telangana INDIA
Tel: 040-64500979, 20020773, Fax: 040-2-4455003
E-mail: gm@mvst.ac.in, gm@mvst.ac.in, gm@mvst.ac.in
Website: www.mvst.ac.in

MCAHAWVER



APPROVED BY AICTE. AFFILIATED TO JNTU R14, HYDR.

DEPARTMENT OF MECHANICAL ENGINEERING

List of students enrolled in Auto CAD (2016-2017)

S.No	Roll No	Name of the student	2/5/16	3/5/16	4/5/16	5/5/16	6/5/16	7/5/16	8/5/16	9/5/16	10/5/16	11/5/16	12/5/16
1	15E31A0301	ABDUL ABRAR	P	P	P	P	P	P	P	P	P	P	P
2	15E31A0302	ABDUL RAHMAN	P	P	P	P	P	P	P	P	P	P	P
3	15E31A0303	ANAND KUMAR	P	P	P	P	P	P	P	P	P	P	P
4	15E31A0304	AQUEEB UDDIN FIRDUSHI	P	P	P	P	P	P	P	P	P	P	P
5	15E31A0305	ATTLURI SURESH REDDY	P	P	P	P	P	P	P	P	P	P	P
6	15E31A0306	BANDA SATYA SHIVA REDDY	P	P	P	P	P	P	P	P	P	P	P
7	15E31A0310	BHOOMENI NAKENDHAR	P	P	P	P	P	P	P	P	P	P	P
8	15E31A0311	BICKUNDA SUNIL KUMAR	P	P	P	P	P	P	P	P	P	P	P
9	15E31A0313	CHIDIRALA RAJKUMAR	P	P	P	P	P	P	P	P	P	P	P
10	15E31A0315	DESHAGOUNI MOHAN SAI	P	P	P	P	P	P	P	P	P	P	P

PRINCIPAL

M. A. V. R. S. S. S.

Principal
(Signature)

Vysavi, Banthiguda Post, Kothavalasa
 Hyd-500 045, Telangana (INDIA)
 Tel: 040-84696979, 20820773, Fax: 040-2455003
 E-mail: principal.mahaveer@mahaveer.ac.in
 Website: www.mahaveer.ac.in

MAHAVER



Approved by AICTE. Affiliated to JNTU-Hydr.

DEPARTMENT OF MECHANICAL ENGINEERING

List of students enrolled in Auto CAD (2016-2017)

11	15E31A0317	GURRALA VENKATA NARSI REDDY	P	P	P	P	P	P	P	P	P	P	P
12	15E31A0318	HUSSAIN FAIZ ULLAH	P	P	P	P	P	P	P	P	P	P	P
13	15E31A0319	K SAMPATH KASIREDDY	P	P	P	P	P	P	P	P	P	P	P
14	15E31A0320	SAIMANOJ REDDY	P	P	P	P	P	P	P	P	P	P	P
15	15E31A0321	KATTA SRIKANTH REDDY	P	P	P	P	P	P	P	P	P	P	P
16	15E31A0322	KISHETTI NIKHIL	P	P	P	P	P	P	P	P	P	P	P
17	15E31A0325	M.A.LATEEF MANCHIKANTI	P	P	P	P	P	P	P	P	P	P	P
18	15E31A0327	ARAVIND REDDY	P	P	P	P	P	P	P	P	P	P	P
19	15E31A0329	MD UBED UL RAHMAN	P	P	P	P	P	P	P	P	P	P	P
29	15E31A0331	MOHAMMED ABDULLAH ZUBAIR	P	P	P	P	P	P	P	P	P	P	P

REVISION
 1/1/2017
 1/1/2017



DEPARTMENT OF MECHANICAL ENGINEERING

List of students enrolled in Auto CAD (2016-2017)

42	15E31A0363	TANNEERU RAJA	P	P	P	P	P	P	P	P	P	P	P	P	P	P	P	P	P
43	15E31A0365	VANGAPALLY SRINIVAS	P	P	P	P	P	P	P	P	P	P	P	P	P	P	P	P	P
44	16E35A0301	AMAR BIRADAR	P	P	P	P	P	P	P	P	P	P	P	P	P	P	P	P	P
45	16E35A0302	BHUKYA RAMA	P	P	P	P	P	P	P	P	P	P	P	P	P	P	P	P	P
46	16E35A0303	DHARAVATHI RAVINDER NAYAK	P	P	P	P	P	P	P	P	P	P	P	P	P	P	P	P	P
47	16E35A0304	EROJI SURESH	P	P	P	P	P	P	P	P	P	P	P	P	P	P	P	P	P
48	16E35A0305	GOURAV KUMAR JHA	P	P	P	P	P	P	P	P	P	P	P	P	P	P	P	P	P
49	16E35A0306	KALIKOTA SAM CHARAN	P	P	P	P	P	P	P	P	P	P	P	P	P	P	P	P	P
50	16E35A0307	MANYALA SATEJA	P	P	P	P	P	P	P	P	P	P	P	P	P	P	P	P	P
51	16E35A0308	TADEM BIHARATHI KUMAR	P	P	P	P	P	P	P	P	P	P	P	P	P	P	P	P	P
52	16E35A0310	TANGELLA ASHOKA VARDHAN RAJU	P	P	P	P	P	P	P	P	P	P	P	P	P	P	P	P	P



MAHAVEER
INSTITUTE OF SCIENCE & TECHNOLOGY

Approved by AICTE, Affiliated to JNTU, Hyderabad.
Vyasaapur, Bhalapalle, Post: Bhalapalle, Hyderabad-500005.

ESTD: 2001



About the College

As an Institute committed in quality education, MIST aims at providing learning with a Technology-edge. It endeavors to provide consistent training to its students to help them evolve as competent professionals in the highly competitive world. Right from its inception in 2001, it has been tuning itself to meet this objective. A new civilization is emerging in our lives. This civilization brings with it a new way of working. Millions are already tuning their lives to the rhythms of tomorrow.

About the Mechanical Dept.

The Mechanical engineering is one of the core engineering departments, which has potential to accommodate all efficient engineers. The Mechanical engineers serve all other branches of engineering directly or indirectly. The Mechanical engineers can find their place in Automobile engineering sector, Steel Plants, Power plants, Software industries, Manufacturing industries, Design industries, Military, Naval and Air force, Defense research organizations, Material research organizations etc.

About the Workshop

CATIA delivers the unique ability not only to model any product, but to do so in the context of its real-life behavior design in the age of experience. CATIA (Computer-Aided Three dimensional Interactive Application) software is a complete multi-platform solution for computer-aided design, manufacturing, engineering, 3D and PLM. Marketed by manufacturer Dassault Systemes, the software is ideal for creating solids, surfaces, assemblies, drawings, fabrication and analysis. However, CATIA offers more advanced functionality for surfaces and modules for different industries.

Organizing committee

CHIEF PATRON

Sri.S.Sudershan Reddy

Chairman

Sri. S. Surendar Reddy

Secretary

Sri S. Dhanunjay Reddy

Joint Secretary

DIRECIOR

Dr. H. S. N. Murthy

PATRON

Dr K.S.S.N Reddy, Principal

CONVENER

Mr.G.K.ShanmukhDev

Asso. Prof, Dept. Of Mechanical

PROGRAM COORDINATORS

Mr.G.K.ShanmukhDev

Mr.B.Venkateswar Reddy

Duration

02/05/2016-12/5/2016

**Two week
Certification Course
on**

Introduction to CATIA

Organized by

**Department of Mechanical
Engineering**

Vysapuri, Bandlaguda Post-Keshavnagar,
Hyderabad-500 005, Telangana INDIA
Tel: 040-64596979, 20020773, Fax: 040-24455003
E-mail: principal.mahaveer@gmail.com
Website: www.mist.ac.in

MAHAVEER



Approved by AICTE, Affiliated to JNTUHYD

Date: 29-04-2016

To
The Principal
MIST,
Hyderabad.

Sub: Proposal for Add-on Course-Reg.

Respected sir,

We are going to conduct 10 days- Technical Training for III B. Tech students on "Introduction to CATIA". We require your approval to go head for proceeding and hope to get an opportunity to serve you the best.

With thanks and regards

Kishu

G.K. Shanmukh Dev
G.K.SHANMUKH DEV

HOD

Department of Mechanical Engineering

PRINCIPAL
MAHAVEER
INSTITUTE OF TECHNOLOGY AND ENGINEERING
VYSAPURI, BANDLAGUDA POST, KESHAVNAGAR,
HYDERABAD-500 005, TELANGANA INDIA



Date: 30.04.2016

CIRCULAR

Technical Training for III B. Tech students are starting from 2nd MAY, 2016 onwards. All HODs and Placements coordinators have to manage the trainings and ensure 95% attendance all through the sessions.

All Mentors need to send the compiled feedback report to G. K. Shanmukh Dev, HOD.

Agenda:

1. Introduction to CATIA.

Design and Development of curriculum for Add on course:

Name of the Faculty : 1. G.K.Shanmukh Dev

PRINCIPAL
MAHAVEER
INSTITUTE OF SCIENCE & TECHNOLOGY
BANDLAGUDA
HYDERABAD - 500 005

G.K. Shanmukh Dev
G.K.SHANMUKH DEV

HOD

Department of Mechanical Engineering



CATIA SYLLABUS

Total Hours: 48

I. Introduction:

- Modulus
- Features (powerful Tools
- Parametric modeling
- Feature based approach
- Parent – child Relationship)
- Associative and Model Centric
- b) Information about Interface
- Tools, Menu, etc.

II. Sketcher:

- Getting Started
- Interface
- Sketch tools
- Profiles
- Operations
- Constraints
- Sketcher preferences
- References

III. Part Features:

- Sketch Based Features
- Pad
- Pocket
- Thin
- Shaft
- Groove

Kishu

PRINCIPAL
MAHAVEER
INSTITUTE OF TECHNOLOGY
Bandlaguda, Hyderabad



- Hole
- Threaded Hole
- Rib
- Slot,Stiffener
- Multi section solid

IV.Dress-up Features

- Fillet
- Chamfer
- Draft
- Shell
- Thickness
- Thread/Tap

V.ReferenceElement

- Point
- Line
- Plane

VI. Assembly Modeling:

- Assembly Constraints
- Manipulation
- Defining a multi & fast multi-instantiation
- Analyzing an assembly

VII. Drafting:

- Sheets & Views
- View modification
- Generating dimensions
- Bill of material

Synopsis: Bandlaguda Post Mahaveer
Hyderabad-501 005, Telangana INDIA
Tel: 040 8459079, 20020773, Fax: 040 2445003
E-mail: principal.mahaveer@mahaveer.com
Website: www.mahaveer.com

MAHAVEER



Approved by AICTE Affiliated to JNTUH Hyd

- Dimensions
- Annotations
- Dress up Elements
- Properties
- Exporting and Importing files

Khatij

PRINCIPAL
MAHAVEER
INSTITUTE OF SCIENCE & TECHNOLOGY
Bandlaguda, Hyderabad-501 005.



Department of Mechanical Engineering CATIA Technical Training student attendance list 2016-17

S.NO.	ROLL NO	NAME OF THE STUDENT	YEAR
1	14E31A0301	ALLI ARAVIND	III
2	14E31A0302	ANNAPU PUSHPANJALI	III
3	14E31A0306	B KISHORE	III
4	14E31A0307	B VISHNU	III
5	14E31A0308	BALUSA VIVEK	III
6	14E31A0309	BOTTU SAI MUKUND	III
7	14E31A0310	C SAI KIRAN	III
8	14E31A0311	CHINTHIRALA NAGARJUNA	III
9	14E31A0313	DUDUKA SHIVAKUMAR	III
10	14E31A0314	DUSA YASHWANTH	III
11	14E31A0315	EPPA RAGHU	III
12	14E31A0316	ESUNATHI KALYAN	III
13	14E31A0317	GANGULA VINAY KUMAR REDDY	III
14	14E31A0318	GOPIDI ABHINAV REDDY	III
15	14E31A0319	GORIGE RAVIKANTH	III
16	14E31A0320	GOWLIKAR BHARGAV KUMAR	III
17	14E31A0321	JADALA VAMISHI KRISHNA	III
18	14E31A0322	JITENDRA SINGH	III
19	14E31A0323	KATAPAAGA NIKHIL KALYAN	III
20	14E31A0325	KASOJU SAI KIRAN	III
21	14E31A0326	KATAKAM VINODKUMAR	III
22	14E31A0327	YAMINI SAI KUMAR	III
23	14E31A0328	KOTTALA SUSHMITHA	III
24	14E31A0329	KUCHANPALLY SANTHOSH REDDY	III
25	14E31A0330	MADDIBOENA SIVAPRAGATHILAKSHMI	III
26	14E31A0331	MAMMAI AKHILESH	III
27	14E31A0333	MEDI AKHIL	III
28	14E31A0338	MOHAMMED KHAN	III
29	14E31A0340	MOHD AJAZ KHAN	III
30	14E31A0343	MOTHAJIGARI VIJAY	III
31	14E31A0346	MUPPARAM SADHANA	III
32	14E31A0347	NEELI AKASH	III
33	14E31A0348	P KRISHNA	III

Handwritten signature
Principal
MAHAVEER
Department of Mechanical Engineering
Banilapada Post, Keshavnagar, Hyderabad-500004

Vysapuri, Bandlaguda Post Keshavnagar,
Hyderabad 500 005, Telangana INDIA
Tel: 040 64096979, 20020773, Fax: 040 24455003
E-mail: principal@mahaveer@gmail.com
Website: www.mst.ac.in

MAHAVEER



Approved by AICTE - Affiliated to JNTU(Hydr)

34	14E31A0349	PALATI RUKMANGADIDU	III
35	14E31A0353	SHAIK AQIB	III
36	14E31A0354	SHAIK MOHAMMED RAYAN	III
37	14E31A0355	SHAIK SOHAIL	III
38	14E31A0358	SYED MUZAMEEL ALI	III
39	14E31A0360	VADLA PRASHANTH	III
40	14E31A0361	AMIT KUMAR PANDEY	III
41	14E31A0363	ARROJU SHRAVANKUMAR	III
42	14E31A0365	BOMMARAJU SAIKUMAR	III
43	14E31A0367	FAZAL AHMED KAMIL	III
44	14E31A0369	G RAGHUVERDHAN REDDY	III
45	14E31A0372	GORIGE NARENDER	III
46	14E31A0377	JAMALPUR ADITHYA	III
47	14E31A0378	KADAVENDI ARAVIND	III
48	14E31A0380	KOPPULA NARESH REDDY	III
49	14E31A0382	MA RAHEMAN	III
50	14E31A0383	MD MUQTAR AHMED KHAN	III
51	14E31A0384	MOHAMMED ABDUL RAHEMAN	III
52	14E31A0385	MOHAMMED OMER	III
53	14E31A0387	MOHAMMED AKBAR	III
54	14E31A0388	MOHD FAROOQ	III
55	14E31A0389	MOHD SOHAIL	III
56	14E31A0391	N VINESH REDDY	III
57	14E31A0392	NANDIGAM SURENDRA	III
58	14E31A0393	PITLA SWAMY	III
59	14E31A0396	RINIU GEORGE	III
60	14E31A03A0	VAIDURI KRISHNA	III
61	14E31A03A1	YERRA ARVIND REDDY	III
62	14E31A03A2	SHEOB AHMED	III
63	14E31A03A3	SYED MD AHMED MOHIUDDIN QUADRI	III
64	13E31A0380	MOHD FARHAN UDDIN	III
65	15E35A0302	H AKHILESH	III
66	15E35A0303	HEERAKAR RAHUL	III
67	15E35A0304	MAMIDIGA NAGESH	III
68	15E35A0305	MD SHOEB AKRAM	III
69	15E35A0307	MYAKALA SHIVAKUMAR	III
70	15E35A0308	SYED ASHFAQ	III
71	13E31A0318	C VENKATESH	III

Kalyan

PRINCIPAL
MAHAVEER
EDUCATION SOCIETY
HYDRABAD



Technical Training Exam on Catia Software (A.Y-2016-17)

2x10=20 Marks

Answer All the Questions

1. Draw the given figure by using Catia software.

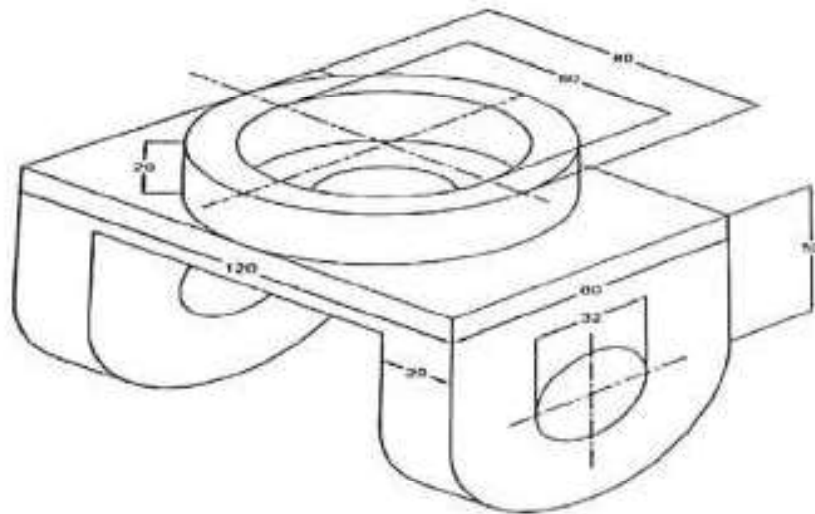

2. Draw the given 2D model into 3D model by using Catia.

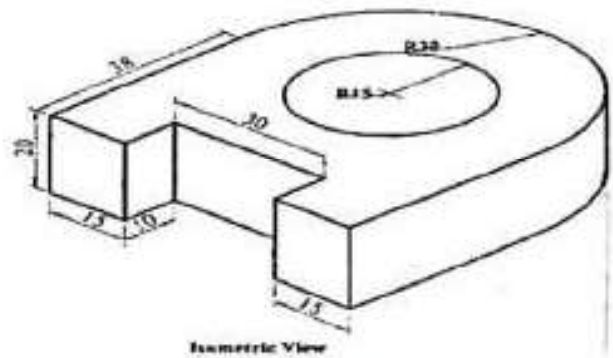
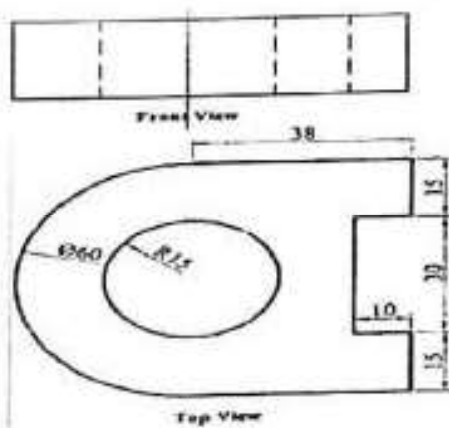

Handwritten signature and stamp in blue ink.

Vysapur, Bandlaguda Post, Keshavnagar,
Hyderabad 500 005, Telangana INDIA
Tel: 040-64596379, 20070773, Fax: 040-24655003
E-mail: principal.mahaveer@gmail.com
Website: www.mist.ac.in

MAHAVEER



Approved by AICTE - Affiliated to JNTUH Hyderabad

Department of Mechanical Engineering CATIA Technical Training student Marks list 2016-17

Sl.NO	Roll No	Name of the student	YEAR	MARKS	PASS/FAIL
1	14E31A0301	ALLI ARAVIND	III	15	PASS
2	14E31A0302	ANNAPU PUSHIPANJALI	III	16	PASS
3	14E31A0306	B KISHORE	III	18	PASS
4	14E31A0307	B VISHNU	III	15	PASS
5	14E31A0308	BALUSA VIVEK	III	15	PASS
6	14E31A0309	BOTTU SAI MUKUND	III	15	PASS
7	14E31A0310	C SAI KIRAN	III	16	PASS
8	14E31A0311	CHINTHIRALA NAGARJUNA	III	15	PASS
9	14E31A0313	DUDUKA SHIVAKUMAR	III	16	PASS
10	14E31A0314	DUSA YASHWANTH	III	12	PASS
11	14E31A0315	EPPA RAGHU	III	15	PASS
12	14E31A0316	ESUNATHI KALYAN	III	16	PASS
13	14E31A0317	GANGULA VINAY KUMAR REDDY	III	12	PASS
14	14E31A0318	GOPIDI ABHINAV REDDY	III	15	PASS
15	14E31A0319	GORIGE RAVIKANTH	III	16	PASS
16	14E31A0320	GOWLIKAR BHARGAV KUMAR	III	14	PASS
17	14E31A0321	JADALA YAMSHI KRISHNA	III	15	PASS
18	14E31A0322	JITENDRA SINGH	III	17	PASS
19	14E31A0323	KATAPAAGA NIKHIL KALYAN	III	15	PASS
20	14E31A0325	KASOJU SAIKIRAN	III	16	PASS
21	14E31A0326	KATAKAM VINODKUMAR	III	16	PASS
22	14E31A0327	YAMINI SAI KUMAR	III	15	PASS
23	14E31A0328	KOTTALA SUSHMITHA	III	16	PASS
24	14E31A0329	KUCHANPALLY SANTHOSH REDDY	III	14	PASS
25	14E31A0330	MADDIBOENA SIVAPRAGATHILAKSHMI	III	15	PASS
26	14E31A0331	MAMMAI AKHILESH	III	15	PASS
27	14E31A0333	MEDI AKHIL	III	16	PASS
28	14E31A0338	MOHAMMED KHAN	III	14	PASS
29	14E31A0340	MOHD AJAZ KHAN	III	15	PASS
30	14E31A0343	MOTHAJIGARI VIJAY	III	15	PASS
31	14E31A0346	MUPPARAM SADHANA	III	14	PASS

Kanhu
P.P. 11/11/17
MAH
INSTITUTE OF
ENGINEERING

Synergy, Bangalore & First Kashi.com
Hyderabad 500 005, Telangana-INDIA
Tel: 040-8430979-20026731 Fax: 040-2488003
E-mail: principal.mahaveer@gmail.com
Website: www.mv.ac.in

MAHAVEER



Approved by AICTE, Government of India, Dt:10/04/19/27

70	15E35A0308	SYEDASHFAQ	III	16	PASS
71	13E31A0318	C VENKATESH	III	17	PASS

Kishu
PRINCIPAL
MAHAVEER
EDUCATION SOCIETY
Bangalore, 560 005, India



CATIA COURSE Summary

- In this course, you will learn how to utilize the core functionality enhancements in Catia.
- First, you will become familiar with using and customizing the new ribbon interface in Catia.
- The new measure and sectioning interfaces will also be examined. Next, you will become familiar with the Sketcher workflow and reference enhancements.
- Part modeling enhancements to features such as Extrude, Corner Chamfer, Sweeps, Blends, and Datum Curves will then be examined.
- You will also learn about new and enhanced Assembly capabilities, such as selecting multiple components, the new relationship constraints, and enhancements for dragging components.
- Then, you will examine the new Table and Balloon functionality for 2-D drawings, and review various detailing enhancements.
- At the end of each module, you will complete a set of review questions to reinforce critical topics from that module. At the end of the course, you will complete a course assessment in Catia intended to evaluate your understanding of the course as a whole.

Copy to :

1. Department of Notice Board
2. Principal for Information
3. Committee Members (Academic)

MAHAVEER
EDUCATION SOCIETY
HYD-500 005.

Vysakh, Bandlaguda First Keshavnagar
Hyderabad 500 005, Telangana INDIA
Tel: 040 64596979 20020773, Fax: 040 24435003
E-mail: principal.mahaveer@gmail.com
Website: www.mist.ac.in

MAHAVEER



Approved by AICTE, Affiliated by JNTUHY1

CERTIFICATE OF COURSE COMPLETION

This certificate is presented to N. Akash of
MIST, who has successfully completed technical training course on
"CATIA" held from 02-05-2016 to 12-05-2016 and found the
student performance to be excellent.

K. Veer
Principal
MIST
Bandlaguda, Hyderabad



ESTD : 2001

G.K. Shanmukh Dev
G.K. SHANMUKH DEV

HOD

Department of Mechanical Engineering

About the College

As an Institute committed in quality education, MIST aims at providing learning with a Technology-edge. It endeavors to provide consistent training to its students to help them evolve as competent professionals in the highly competitive world. Right from its inception in 2001, it has been tuning itself to meet this objective. A new civilization is emerging in our lives. This civilization belongs with a new way of working. Millions are already tuning their lives to the rhythms of tomorrow.

About Mechanical Dept.

The Mechanical engineering is one of the core engineering departments, which has potential to accommodate all efficient engineers. The Mechanical engineers serve all other branches of engineering directly or indirectly. The Mechanical engineers can find their place in Automobile engineering sector, Steel Plants, Power plants, Software industries, Manufacturing industries, Design industries, Military, Naval and Air force, Defense research organizations, Material research organizations etc.

About the Workshop

The course builds from the big ideas in finite element analysis and computational fluid dynamics to ANSYS case studies that progress from real world applications and examples. ANSYS is the flagship engineering software solution that uses finite element analysis (FEA), which is a numerical and computational method used to solve the real engineering problems related to physics, structural analysis, heat transfer, fluid flow, mass transport, and electromagnetic potential field. To solve the problem, it subdivides a large problem into smaller, simpler parts that are called finite elements and solve the problem by minimizing an associated error function.

Organising committee

CHIEF PATRON

Sri.S.Sudershan Reddy

Chairman

Sri. S. Surendar Reddy

Secretary

Sri S. Dhanunjay Reddy

Joint Secretary

DIRECTOR

Dr. H. S. N. Murthy

PATRON

Dr.S.S.S.N.Reddy,Principal

CONVENER

G.K.Shanmukh Dev,

ASSO.Prof,Dept. Of Mechanical

PROGRAM COORDINATORS

G.Siva Giridhar Yadav

Conducted On

02/05/2016- 13/05/2016



MAHAVEER

INSTITUTE OF SCIENCE & TECHNOLOGY

Approved by AICTE, Affiliated to JNTU, Hyderabad.

Venugopal, Binnaguda, Post: Keshavnagar, Hyderabad-500005.

ESTD: 2001



Two week

Certification Course

on

ANSYS

Organized by

Department of Mechanical
Engineering

Vysapuri, Bandlaguda Post:Keshavpuri,
Hyderabad-500 605, Telangana INDIA
Tel: 040-24459979,20020773, Fax: 040-24455003
E-mail: principal.mahaveer@gmail.com
Website: www.mist.ac.in

MAHAVEER



Approved by AICTE, Affiliated to JNTUH Hyd

Date: 30-04-2016

To
The Principal
MIST,
Hyderabad.

Sub: Proposal for Add-on Course-Reg.

Respected sir,

We are going to conduct 10 days Technical Training for IV B. Tech students on "Introduction to ANSYS". We require your approval to go ahead for proceeding and hope to get an opportunity to serve you the best.

With thanks and regards

Kishu
PRINCIPAL
MAHAVEER
INSTITUTE OF TECHNOLOGY & ENGINEERING
VYSAPURI, BANDLAGUDA POST, KESHAVPURI,
HYDERABAD-500 605, TELANGANA INDIA

G.K. Shanmukh Dev
G.K.SHANMUKH DEV

HOD

Department of Mechanical Engineering



Date: 01.05.2016

CIRCULAR

Technical Training for IV B. Tech students are starting from 2nd MAY, 2016 onwards, All HODs and Placements coordinators have to manage the trainings and ensure 95% attendance all through the sessions.

All Mentors need to send the compiled feedback report to G.K.Shanmukh Dev, HOD at e3hod.mech@gmail.com daily.

Agenda: 1. Introduction to ANSYS.

Design and Development of curriculum for Add on course:

Name of the Faculty : G.Siva Giridhar Yadav

PRINCIPAL
MAHAVEER
INSTITUTE OF SCIENCE & TECHNOLOGY
BANDLAGUDA, HYD-500 005.

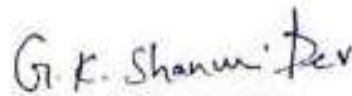
G.K.SHANMUKH DEV

HOD

Department of Mechanical Engineering

Vysapuri, Bandlaguda Post, Keshavnagar,
Hyderabad-500 005, Telangana INDIA
Tel: 040-64596979, 20020773, Fax: 040-24455003
E-mail: principal.mahaveer@gmail.com,
Website: www.mst.ac.in

MAHAVEER



Approved by AICTE. Affiliated to JNTUH Hyd

ANSYS SYLLABUS

S.NO	TOPIC COVERED	DURATION (Hours)
1	INTRODUCTION TO FEA AND	3
2	BASIC SOLID MODELING	3
3	ADVANCED SOLID MODELING	3
4	FINITE ELEMENT MODELING (FEM) - I	3
5	FINITE ELEMENT MODELING (FEM) - II	3
6	SOLUTION AND POSTPROCESSOR	3
7	STATIC STRUCTURAL ANALYSIS	3
8	ADVANCED STRUCTURAL ANALYSIS (DYNAMIC AND NONLINEAR)	3
9	ADVANCED STRUCTURAL ANALYSIS	2
10	THERMAL ANALYSIS	2
11	GENERATING THE REPORT OF ANALYSIS	2

K. Srinivas

PRINCIPAL
MAHAVEER
INSTITUTE OF TECHNOLOGY
BANDLAGUDA POST, VYSAPURI,
HYDERABAD-500 005, T.S.



Department of Mechanical Engineering ANSYS Technical Training student attendance list 2016-2017

S.NO.	ROLL NO.	NAME OF THE STUDENT	YEAR
1	13E31A0302	AENUGU MAHESH	IV
2	13E31A0303	AERAGONI MAHESH	IV
3	13E31A0305	ALI HASAN BAMSADOOS	IV
4	13E31A0306	AMGOTH SUNILKUMAR	IV
5	13E31A0307	ANTHATI JASHWANTH GOUD	IV
6	13E31A0308	ANTHATI PRAVEEN	IV
7	13E31A0309	AVARI SAICHAND	IV
8	13E31A0310	AVUCHARLA RAKESH	IV
9	13E31A0311	AVULA GOPI	IV
10	13E31A0312	AVULA LOHIT	IV
11	13E31A0314	BANALA SANDEEP	IV
12	13E31A0315	BANDI MURALIDHAR	IV
13	13E31A0316	BOLISHETTI VAMSHI KRUSHNA	IV
14	13E31A0317	BOMMARAJU SAI MANOJ KUMAR	IV
15	13E31A0319	CHAGANTI VENKATESH	IV
16	13E31A0320	CHAPIDI KRISHNAKANTH	IV
17	13E31A0322	CHINTA BENU MADHAV	IV
18	13E31A0323	BOROLE AKASH	IV
19	13E31A0324	DEVARKONDA BALAJI	IV
20	13E31A0325	GUDAVALLI SREEDHAR	IV
21	13E31A0326	GUMMADAVELLI DURGA VENKATA RAMA TEJA	IV
22	13E31A0327	JANGILI NAVEEN	IV

K. Srinivas
PRINCIPAL
MAHAVEER
INSTITUTE OF SCIENCE AND TECHNOLOGY
Bandlaguda, Hyderabad-500005

Vysapuri, Bandlaguda Post, Keshavnagar,
Hyderabad-500 005, Telangana INDIA.
Tel: 040-84596079, 26020773, Fax: 040-24435003
E-mail: principal.mahaveer@ymail.com
Website: www.must.ac.in

MAHAVEER



Approved by AICTE - Affiliated to JNTU-Hyd

23	13E31A0328	JUBREVAR AKSHAY	IV
24	13E31A0329	K J V CHAITANYA KUMAR	IV
25	13E31A0330	K. PAVAN KUMAR	IV
26	13E31A0331	KADAVAKOLLU BHAVANI SANKAR	IV
27	13E31A0332	KARNI VEERENDRA	IV
28	13E31A0333	KATTA KRANTHI KUMAR	IV
29	13E31A0337	MALOTHI SURENDER NAYAK	IV
30	13E31A0338	MD IRFAN	IV
31	13E31A0339	MOHAMMED AHMED MOHUDDIN	IV
32	13E31A0340	MOHAMMED SHOIB ALI	IV
33	13E31A0341	MONGALA ABHINAV	IV
34	13E31A0342	MUSHKAM SHEKHAR	IV
35	13E31A0343	PARVATHA VINAY KUMAR	IV
36	13E31A0344	PEDDINTY RANJITH KUMAR	IV
37	13E31A0345	PERURI VIJAY KUMAR	IV
38	13E31A0346	PORANDLA SHARATHCHANDRA	IV
39	13E31A0347	R KAMAL	IV
40	13E31A0348	RAMELLI VAMSHIDHER	IV
41	13E31A0349	RAPARITHI ANIL KUMAR	IV
42	13E31A0351	S.MUKESH KUMAR	IV
43	13E31A0352	SAMDELA MANEESH	IV
44	13E31A0353	SATLA SRIKAR RAJ	IV
45	13E31A0354	SHAH MAHAMMED RIZWAN TABARUK ALI	IV
46	13E31A0356	SUNKI SRINIVAS	IV
47	13E31A0357	SWAMY SACHIDANAND	IV
48	13E31A0358	THATI KRISHINA RAO	IV

K. S. S. S.
PRINCIPAL
M. MAHAVEER
OF SCIENCE & TECHNOLOGY
BANDLAGUDA, HYD-500 005.

Vysapuri, Bandlaguda Post Keshavnagar,
Hyderabad-500 005, Telangana INDIA
Tel: 040-64596379, 20020773, Fax: 040-24455003
E-mail: principal.mahaveer@gmail.com,
Website: www.nvat.ac.in.

MAHAVEER



Approved by AICTE, Affiliated to JNTU(Hydr)

49	13E31A0359	THATIKANTH ANIL	IV
50	13E31A0360	VIKAS KUMAR	IV
51	13E31A0361	D SAI AKASHI	IV
52	13E31A0362	DAMERA RANJITH	IV
53	13E31A0363	DEGA MADHUKAR	IV
54	13E31A0364	DHARAVATHI ROOP SINGH	IV
55	13E31A0365	ERRI KAMALAKAR	IV
56	13E31A0366	G VENKATESH	IV
57	13E31A0367	GONALOLU PRADEEP KUMAR	IV
58	13E31A0368	GUDELLI VJAYKUMAR	IV
59	13E31A0369	J.SHIVA RAJ	IV
60	13E31A0370	JADDU EKAMBARA SRINIVASA PHANI KUMAR	IV
61	13E31A0371	JALINGAM HEMANTH KUMAR	IV
62	13E31A0372	K BHARATHSIMHA REDDY	IV
63	13E31A0373	K PRAVEEN	IV
64	13E31A0375	K SANDEEP REDDY	IV
65	13E31A0376	K SHIVAJI	IV
66	13E31A0377	KADANACHI ADARSH KUMAR	IV
67	13E31A0379	M RAMU	IV
68	13E31A0381	MOHITH S.R. MANE	IV
69	13E31A0382	MOLLA NOOR BASHA	IV
70	13E31A0383	P.PRADEEP NAIK	IV
71	13E31A0384	PANDEY PRINCE CHINTAMANI	IV
72	13E31A0385	RETINENI BALARAM	IV
73	13E31A0387	SYED MUFAQUAM ALI	IV
74	13E31A0388	SYED ZIAUDDIN	IV

K. Srinivasulu Reddy
PRINCIPAL
MAHAVEER
EDUCATION SOCIETY
Bandlaguda, Hyderabad-500 005.

Vysapuri, Bandlaguda Post Keshavnagar,
Hyderabad-500 005, Telangana INDIA
Tel: 040-64550979, 20020773, Fax: 040-24455093
E-mail: principal.mahaveer@gmail.com
Website: www.mst.ac.in

MAHAVEER



Approved by AICTE, Affiliated to JNTU-Hyd

75	13E31A0389	T.DIVYA TEJA	IV
76	13E31A0390	T.VINEETHI	IV
77	13E31A0391	THADAKAPPELLI PRAVEEN	IV
78	13E31A0392	THATIKONDA SREERKAR	IV
79	13E31A0393	THOTA RAMESH	IV
80	13E31A0394	TIPPANI ASHREETH PRASHANTH	IV
81	13E31A0395	VADICHARLA RAMESH	IV
82	13E31A0396	Y LALITH KUMAR	IV
83	13E31A0398	GANGULA SRINIVAS	IV
84	13E31A0399	DASARI RAJU PRANEETH	IV
85	13E31A03A0	MANNEM JASVANTH	IV
86	13E31A03A1	SODI ARJUN	IV
87	13E31A03A2	MUDAVATH NARESH	IV
88	14E35A0303	SONU GUPTA	IV

Kshirika
PRINCIPAL
MAHAVEER
INSTITUTE OF SCIENCE & TECHNOLOGY
Bandlaguda, Hyderabad-500 005.



Technical Training Exam on ANSYS Software (A.Y-2016-2017)

2x10=20 Marks

Answer All the Questions

1. Given the 2D truss structure represented in Figure 1.1, where:
- $h = 5$ m
 - $L = 3$ m
 - $P = 1000$ N
 - $E = 1.0 \times 10^9$ N/m² (Young's modulus)
 - $A = 0.1$ m² (Cross-section area of each beam element)

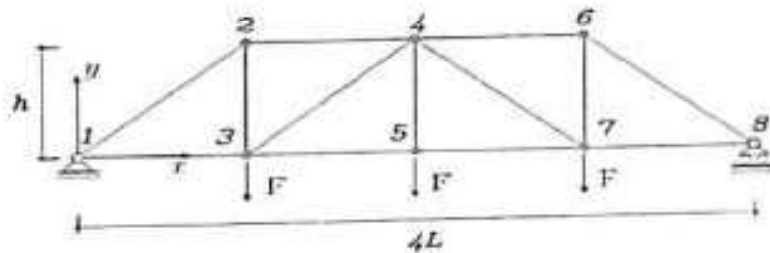

Figure 1.1: Example truss structure, constraints and loads

2.

- 7.13 Determine the stresses in the plate with the hole subjected to the tensile stress shown in Figure P7-13. Graph the stress variation σ_x versus the distance y from the hole. Let $E = 200$ GPa, $\nu = 0.25$, and $r = 25$ mm. (Use various mesh densities, depending on your computer program in your finite element model.) Use symmetry as appropriate.

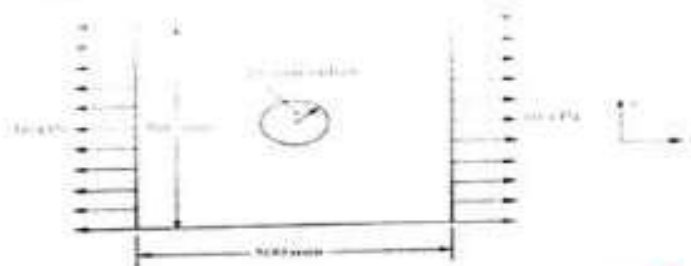

Figure P7-13

Principal
PRINCIPAL
M. MAHAVEER
- VIKRANT TECHNOLOGIST
Bandlaguda, Hyderabad 500 005.



Department of Mechanical Engineering					
ANSYS Technical Training student attendance list 2016-2017					
S.NO	Roll No	Name of the student	YEAR	MARKS	PASS/FAIL
1	13E31A0302	AENUGU MAHESH	IV	15	PASS
2	13E31A0303	AERAGONI MAHESH	IV	16	PASS
3	13E31A0305	ALI HASAN BAMA SDOOS	IV	18	PASS
4	13E31A0306	AMGOTHI SUNIL KUMAR	IV	15	PASS
5	13E31A0307	ANTHATI JASHWANTH GOUD	IV	15	PASS
6	13E31A0308	ANTHATI PRAVEEN	IV	15	PASS
7	13E31A0309	AVARI SAICHAND	IV	16	PASS
8	13E31A0310	AVUCHARLA RAKESH	IV	15	PASS
9	13E31A0311	AVULA GOPI	IV	16	PASS
10	13E31A0312	AVULA LOHIT	IV	12	PASS
11	13E31A0314	BANALA SANDEEP	IV	15	PASS
12	13E31A0315	BANDI MURALIDHAR	IV	16	PASS
13	13E31A0316	BOLISHETTI VAMSHI KRUSHNA	IV	12	PASS
14	13E31A0317	BOMMARAJU SAI MANOJ KUMAR	IV	15	PASS
15	13E31A0319	CHAGANTI VENKATESH	IV	16	PASS
16	13E31A0320	CHAPIDI KRISHNA KANTHI	IV	14	PASS
17	13E31A0322	CHINTA BENU MADHAV	IV	15	PASS
18	13E31A0323	BOROLE AKASH	IV	17	PASS
19	13E31A0324	DEVARKONDA BALAJI	IV	15	PASS
20	13E31A0325	GUDAVALLI SREEDHAR	IV	16	PASS
21	13E31A0326	GUMMADAVELLI DURGA VENKATA RAMA TEJA	IV	16	PASS
22	13E31A0327	JANGILI NAVEEN	IV	15	PASS
23	13E31A0328	JUBREVAR AKSHAY	IV	16	PASS

K. Srinivas
 PRINCIPAL
 MAHAVEER
 INSTITUTE OF TECHNOLOGY & RESEARCH
 Venkatpur, Hyderabad-502 005.

Vysrepu, Bandlaguda Post, Keshavnagar,
Hydrabad 500 026, Telangana INDIA
Tel: 040-64896579, 20026773, Fax: 040-24480002
E-mail: principal.mahaveer@gmail.com
Website: www.mca.ac.in

MAHAVEER



Approved by AICTE, Affiliated to JNTUHYD

24	13E31A0329	K J V CHAITANYA KUMAR	IV	14	PASS
25	13E31A0330	K. PAVAN KUMAR	IV	15	PASS
26	13E31A0331	KADAVAKOLLU BHAVANI SANKAR	IV	15	PASS
27	13E31A0332	KARNI VEERENDRA	IV	16	PASS
28	13E31A0333	KATTA KRANTHI KUMAR	IV	14	PASS
29	13E31A0337	MALOTHU SURENDER NAYAK	IV	15	PASS
30	13E31A0338	MD IRFAN	IV	15	PASS
31	13E31A0339	MOHAMMED AHMED MOHUDDIN	IV	14	PASS
32	13E31A0340	MOHAMMED SHOIB ALI	IV	16	PASS
33	13E31A0341	MONGALA ABHINAV	IV	16	PASS
34	13E31A0342	MUSHKAM SHEKHAR	IV	14	PASS
35	13E31A0343	PARVATHA VINAY KUMAR	IV	15	PASS
36	13E31A0344	PEDDINTY RANJITH KUMAR	IV	16	PASS
37	13E31A0345	PERURI VIJAY KUMAR	IV	15	PASS
38	13E31A0346	PORANDLA SHARATHCHANDRA	IV	16	PASS
39	13E31A0347	R KAMAL	IV	14	PASS
40	13E31A0348	RAMELI VAMSHIDHAR	IV	12	PASS
41	13E31A0349	RAPARTHI ANIL KUMAR	IV	15	PASS
42	13E31A0351	S.MUKESH KUMAR	IV	16	PASS
43	13E31A0352	SAMDELA MANEESH	IV	15	PASS
44	13E31A0353	SATLA SRIKAR RAJ	IV	16	PASS
45	13E31A0354	SHAH MAHAMMED RIZWAN TABARUK ALI	IV	15	PASS
46	13E31A0356	SUNKI SRINIVAS	IV	14	PASS
47	13E31A0357	SWAMY SACHIDANAND	IV	18	PASS

K. Subudh

PRINCIPAL
MAHAVEER
INSTITUTE OF STUDIES & RESEARCH
BANDLAGUDA

Vissapuri Bandlaguda Post Keshavnagar,
Hyderabad-500025, Telangana INDIA
Tel: 040-8668979/20320771, Fax: 040-24450002
E-mail: govt.mahaveer@gmail.com
Website: www.mvt.ac.in

MAHAVEER



Approved by AICTE Affiliated to JNTU, HYD

48	13E31A0358	HATH KRISHNA RAO	IV	15	PASS
49	13E31A0359	HATHKANTHANI	IV	16	PASS
50	13E31A0360	VIKAS KUMAR	IV	15	PASS
51	13E31A0361	D SAI AKASH	IV	16	PASS
52	13E31A0362	DAMERA RANJITH	IV	15	PASS
53	13E31A0363	DEGA MADHUKAR	IV	16	PASS
54	13E31A0364	DHARAVATH ROOP SINGH	IV	14	PASS
55	13E31A0365	ERRI KAMALAKAR	IV	12	PASS
56	13E31A0366	G VENKATESH	IV	15	PASS
57	13E31A0367	GONALOLU PRADEEP KUMAR	IV	16	PASS
58	13E31A0368	GUDELLI VIJAYKUMAR	IV	15	PASS
59	13E31A0369	JSHIVA RAJ	IV	16	PASS
60	13E31A0370	JADDU EKAMBARA SRINIVASA PHANI KUMAR	IV	15	PASS
61	13E31A0371	JALINGAM HEMANTH KUMAR	IV	14	PASS
62	13E31A0372	K BHARATHSIMHA REDDY	IV	18	PASS
63	13E31A0373	K PRAVEEN	IV	15	PASS
64	13E31A0375	K SANDEEP REDDY	IV	16	PASS
65	13E31A0376	K SHIVAJI	IV	15	PASS
66	13E31A0377	KADANACHI ADARSH KUMAR	IV	15	PASS
67	13E31A0379	M RAMU	IV	16	PASS
68	13E31A0381	MOHITH S.R. MANE	IV	18	PASS
69	13E31A0382	MOLLA NOOR BASHA	IV	17	PASS
70	13E31A0383	P.PRADEEP NAIK	IV	16	PASS
71	13E31A0384	PANDEY PRINCE CHINTAMANI	IV	15	PASS
72	13E31A0385	RETINENI BALARAM	IV	16	PASS

K. Sankar
PRINCIPAL
MAHAVEER
UNIVERSITY OF EXTENSION & INNOVATION
HYDRABAD, TELANGANA 500025

Venugopal, Bandlaguda Post, Keshavnagar,
Hyderabad 500 005, Telangana INDIA
Tel: 040-64036379, 20020773, Fax: 040-24435093
E-mail: principal@mahaveer@gmail.com
Website: www.mahaveer.in

MAHAVEER



Approved by AICTE, Affiliated to JNTU Hyderabad

73	13E31A0387	SYED MUIAQUAM ALI	IV	18	PASS
74	13E31A0388	SYED ZIAUDDIN	IV	15	PASS
75	13E31A0389	T.DIVYA TEJA	IV	15	PASS
76	13E31A0390	T.VINEETHI	IV	15	PASS
77	13E31A0391	THADAKAPPELLI PRAVEEN	IV	16	PASS
78	13E31A0392	THATIKONDA SREEKAR	IV	15	PASS
79	13E31A0393	THOTA RAMESH	IV	16	PASS
80	13E31A0394	TIPPANI ASHREETHI PRASHANTHI	IV	12	PASS
81	13E31A0395	VADICHARLA RAMESH	IV	15	PASS
82	13E31A0396	Y LALITH KUMAR	IV	16	PASS
83	13E31A0398	GANGULA SRINIVAS	IV	12	PASS
84	13E31A0399	DASARI RAJU PRANEETHI	IV	15	PASS
85	13E31A03A0	MANNEM JASVANTHI	IV	16	PASS
86	13E31A03A1	SODI ARJUN	IV	14	PASS
87	13E31A03A2	MUDAVATH NARESH	IV	15	PASS
88	14E35A0303	SONU GUPTA	IV	17	PASS

K. Srinivas

M/
Principal
Bandlaguda



ANSYS COURSE Summary

Department of Mechanical Engineering

1. The Geometry preparation training course is for users who want to create and modify geometry in preparation for CFD or FEA analysis. The training will be focused in either ANSYS Design Modeler or ANSYS Space Claim.
2. The ANSYS Meshing training course will give you the tools for generating good quality meshes for Fluent and CFX. The trainee will choose which tool should be used: ANSYS Meshing, Fluent Meshing or ICEM CFD.
3. This course will show how to set up a range of simulation types in the ANSYS Fluent or ANSYS CFX solver, as well as how to post process the results by using our CFD Post Tool.
4. This course will show how to set up a range of simulation types in ANSYS Mechanical, as well as how to post process and evaluate your results.
5. To acquire advance knowledge to perform explicit simulations with ANSYS Explicit STR, ANSYS AUTODYN or ANSYS LS-DYNA.
6. This is an introductory to intermediate level training for using ANSYS HFSS for all applications, like RF/microwave, antennas or planar problems. Participants will get understanding of HFSS modeling, solution process and post-processing features, which can be used for other advanced applications. The course will also cover advanced topics like dynamic link between EM and circuit, impedance matching, overview of HFSS 3D layout interface and speeding-up HFSS simulation using HPC.
7. Provide the needed tools for the complete simulation of a pressure Vessel from scratch. Several types of analysis and boundary conditions will be discussed, by using pressure vessels examples.
8. To acquire advance knowledge for performing mechanical simulation in Fixed Offshore Structures.

Copy to :

1. Department of Notice Board
2. Principal for Information
3. Committee Members (Academic)

K. Srinivas
PRINCIPAL
MAHAVEER
INSTITUTE OF TECHNOLOGY
Bapatnagar, Hyderabad-505001

Vysapuri, Bandlaguda Post, Keshavnagar,
Hyderabad 500 085, Telangana, INDIA
Tel: 040-6453670, 20020713, Fax: 949 2445200
E-mail: principal.mahaveer@gmail.com
Website: www.mist.ac.in

MAHAVEER



Approved by AICTE. Affiliated to JNTUH Hyd

CERTIFICATE OF COURSE COMPLETION

This certificate is presented to D. Sai Akash of
MIST, who has successfully completed technical training course on
"ANSYS" held from 02-05-2016 to 13-05-2016 and found the
student performance to be excellent.

K. Srinivas
Principal
MAHAVEER
INSTITUTE OF SCIENCE
AND TECHNOLOGY
BANDLAGUDA POST, KESHAVNAGAR,
HYDERABAD - 500 085



ESTD : 2001

G.K. Shanmukh Dev
G.K. SHANMUKH DEV

HOD

Department of Mechanical Engineering

DEPARTMENT OF MECHANICAL ENGINEERING

List of students enrolled in ANSYS (2016-2017)

S.No	Roll No	Name of the student	2/5/16	3/5/16	4/5/16	5/5/16	6/5/16	7/5/16	10/5/16	11/5/16	12/5/16
1	13E31A0302	AENUGU MAHESH	P	P	P	P	P	P	P	P	P
2	13E31A0303	AERAGONI MAHESH	P	P	P	P	P	P	P	P	P
3	13E31A0305	ALI HASAN BAMA DOOS	P	P	P	P	P	P	P	P	P
4	13E31A0306	AMGOTH SUNIL KUMAR	P	P	P	P	P	P	P	P	P
5	13E31A0307	ANTHATHI JASHWANATH GOUD	P	P	P	P	P	P	P	P	P
6	13E31A0308	ANTHATHI PRAVATHAN	P	P	P	P	P	P	P	P	P
7	13E31A0309	AVARI SAICHAND	P	P	P	P	P	P	P	P	P
8	13E31A0310	AVUCHARLA RAKESH	P	P	P	P	P	P	P	P	P
9	13E31A0311	AVULA GOPI	P	P	P	P	P	P	P	P	P
10	13E31A0312	AVULA LOHITH	P	P	P	P	P	P	P	P	P
11	13E31A0314	BANALA SANDEEP	P	P	P	P	P	P	P	P	P
12	13E31A0315	BANDI MURALI BHAR	P	P	P	P	P	P	P	P	P
13	13E31A0316	BOLISHETTI VAMSHI KRUSHNA	P	P	P	P	P	P	P	P	P
14	13E31A0317	BOMMARAJU SAIVANUJ KUMAR	P	P	P	P	P	P	P	P	P
15	13E31A0319	CHAGANTI VENKATESH	P	P	P	P	P	P	P	P	P
16	13E31A0320	CHAPIDI KRISHN ANANTH	P	P	P	P	P	P	P	P	P
17	13E31A0322	CHINTA BENI MAUDILAV	P	P	P	P	P	P	P	P	P

W. Srinivas
13/05/2016 11:11
13/05/2016 11:11

Vysapuri, Bandlaguda Post:Keshavgiri,

Hyderabad-500 005, TELANGANA INDIA
Tel: 040-64596979,8978380692.Fax: 040-24455003
E-mail: e3hod_it@gmail.com,
Website: www.mist.ac.in,

MAHAVEER

INSTITUTE OF SCIENCE & TECHNOLOGY

Approved by AICTE, Affiliated to JNTUH,Hyd.



DEPARTMENT OF ELECTRONICS AND COMMUNICATION ENGINEERING

Date: 01-08-2016

CIRCULAR

Technical Trainings MS-Office for III B. Tech students are starting from 17-08-2016 onwards. All the students III year ,B.Tech I Semester should attend.

Design and development of curriculum for add-on courses :

Faculty Names: 1.Prof B Visweswar Rao
2.Mr. Ohul Reddy
3. Mr. G. Krishna Murthy

HOD, ECE

Cc: Principal for information
Coordinator to inform the students
Notice board & department File.



PRINCIPAL
MAHAVEER
INSTITUTE OF SCIENCE & TECHNOLOGY
Bandlaguda, Hyd-500 005.

Vysapuri, Bandlaguda Post:Keshavgiri,

Hyderabad-500 005, TELANGANA INDIA
Tel: 040-64596979,8978380692,Fax: 040-24455003
E-mail: e3hod.it@gmail.com,
Website: www.mist.ac.in,

MAHAVEER

INSTITUTE OF SCIENCE & TECHNOLOGY

Approved by AICTE, Affiliated to JNTUH,Hyd.



DEPARTMENT OF ELECTRONICS AND COMMUNICATION ENGINEERING

SYLLABUS FOR Technical Training MS-Office

SNO	TOPIC COVERED	DURATION
1	Ms. word : Creating, editing, saving and printing text documents	3
2	Inserting tables, smart art, page breaks	3
3	Using lists and styles	3
4	Working with images	3
5	Using Spelling and Grammar check	3
6	Mail Merge	3
7	Ms. Excel: Spreadsheet basics	3
8	Creating, editing, saving and printing spreadsheets	3
9	Working with functions & formulas	3
10	Graphically representing data : Charts & Graphs	3
11	Speeding data entry : Using Data Forms	3
12	Analyzing data : Data Menu, Subtotal, Filtering Data	3
13	Ms. Power Point : Opening, viewing, creating, and printing slides	3
14	Applying auto layouts	3
15	Adding custom animation	3
16	Using slide transitions	3
17	Creating Professional Slide for Presentation.	3

K. Sankar

PRINCIPAL
MAHAVEER
INSTITUTE OF SCIENCE & TECHNOLOGY
Bandlaguda, Hyd-500 005.

Vysapuri, Bandlaguda Post:Keshavgiri,

Hyderabad-500 005, TELANGANA INDIA
Tel: 040-64596979,8978380692, Fax: 040-24455003
E-mail: e3hod_it@gmail.com,
Website: www.mist.ac.in,

MAHAVEER

INSTITUTE OF SCIENCE & TECHNOLOGY

Approved by AICTE, Affiliated to JNTUH,Hyd.



DEPARTMENT OF ELECTRONICS AND COMMUNICATION ENGINEERING

LIST OF REGISTERED STUDENTS FOR Technical Training MS-Office

S.No	Hall Ticket No	Name of the Candidate
1	15E31A0403	AKULA SHERCHENDRA
2	15E31A0404	ALLA VENKATA KRISHNA VAMSHI
3	15E31A0405	ALLE VINAY KUMAR
4	15E31A0406	ANNARAM BALAKRISHNA GOUD
5	15E31A0407	B RAKESH
6	15E31A0408	BANDAPELLI SPOORTHI
7	15E31A0409	BHOOKYA YAKANNA
8	15E31A0410	BIRUDU HARINI
9	15E31A0412	BODDU VASU
10	15E31A0413	BONAJURI SRINIVAS
11	15E31A0414	C UMA
12	15E31A0415	D SAITEJA
13	15E31A0416	DAPPU VENKATESH
14	15E31A0417	DOSADA SOWMYA
15	15E31A0418	EDAM SAICHANDANA
16	15E31A0419	GANDLA SAICHANDRA
17	15E31A0421	GODEM MOONIKA
18	15E31A0422	GOPI KIRAN REDDY
19	15E31A0423	GOVIND SOWMYA
20	15E31A0424	GUNTI PRAKASH
21	15E31A0425	KADICHERLA ASHWINI
22	15E31A0426	KAKELETI JAISURYA SRINIVASA RAO
23	15E31A0427	KURMA DATTA SAI
24	15E31A0428	M RADHIKA
25	15E31A0412	MOONIKA THODSAM
26	15E31A0413	NANGUNURI VISIBU
27	15E31A0435	PABBA SUNDARA CHATTANYA
28	15E31A0436	SAI SRUKANTH YADAV
29	15E31A0438	PALIREDDY NARASIMHA REDDY
30	15E31A0439	PASARAM SAJ ABHISHEK

K. Srinivas
PRINCIPAL
MAHAVEER
INSTITUTE OF SCIENCE & TECHNOLOGY
Bandlaguda, Hyd-500 005

Vysapuri, Bandlaguda Post:Keshavgiri,

Hyderabad-500 005, TELANGANA INDIA
Tel: 040-64596979,8978380692 Fax: 040-24455003
E-mail: e3hod.it@gmail.com,
Website: www.mist.ac.in,

MAHAVEER

INSTITUTE OF SCIENCE & TECHNOLOGY

Approved by AICTE, Affiliated to JNTUH,Hyd



DEPARTMENT OF ELECTRONICS AND COMMUNICATION ENGINEERING

Technical Training MS-Office QUESTION PAPER

Duration: 120 Minutes

15 X 2 = 30 Marks

Answer the following all questions. Each question carries 1 mark.

1. How to add foot-note & end note in word?
2. What is the shortcut keys for creating hyperlink?
3. How you can insert an online picture in your word document in word 2013?
4. How you can create a custom watermark?
5. What is the short cut key to insert a page break?
6. What is Microsoft Excel?
7. How can you add cells, rows or columns in Excel?
8. How would you format a cell? What are the options?
9. What are charts in MS Excel?
10. What is Freeze Panes in MS-Excel?
11. Is it possible to make Pivot table using multiple sources of data?
12. What are the advantages of using formula in Excel sheet?
13. What is a Macro in-Excel? How to create an Excel Macro?
14. How can you show your presentation online in PowerPoint?
15. How you can record a slide show in PowerPoint?

HOD-ECE

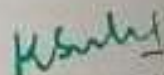
PRINCIPAL
MAHAVEER
INSTITUTE OF SCIENCE & TECHNOLOGY
Bandlaguda, Hyd-500 005

Vysapuri, Bandlaguda Post:Keshavgiri,

MAHAVEER

INSTITUTE OF SCIENCE & TECHNOLOGY

Approved by AICTE, Affiliated to JNTUH,Hyd.



Hyderabad-500 005, TELANGANA INDIA
Tel: 040-64596979,8978380692.Fax: 040-24455003
E-mail: e3hod_it@gmail.com,
Website: www.mist.ac.in,

DEPARTMENT OF ELECTRONICS AND COMMUNICATION ENGINEERING

RESULT SHEET FOR FOR Technical Training MS-Office

S.No	Hall Ticket No	Name of the Candidate	ATTENDANCE(20hrs)	Marks Obtained(30)
1	ISE31A0403	AKULA SHUCHENDRA	17	23
2	ISE31A0404	ALLA VENKATA KRISHNA VAMSHI	20	29
3	ISE31A0405	ALLE VINAY KUMAR	18	23
4	ISE31A0406	ANNARAM BALAKRISHNA GOUD	20	20
5	ISE31A0407	B RAKESH	19	27
6	ISE31A0408	BANDAPILLI SPOKIBITHI	17	24
7	ISE31A0409	BHODKYA YAKANNA	18	21
8	ISE31A0410	BRUDU HARRINI	20	25
9	ISE31A0412	BODDU VASU	20	25
10	ISE31A0413	BONAGIRI SRINIVAS	20	20
11	ISE31A0414	C LUMA	20	21
12	ISE31A0415	D SAITEJA	18	23
13	ISE31A0416	DAPPU VENKATESH	19	22
14	ISE31A0417	DOSADA SOWMYA	20	23
15	ISE31A0418	EDAM SAICHANDANA	8	23
16	ISE31A0419	GANDHARVA SAICHANDRA	20	29
17	ISE31A0421	GODEM MOONIKA	18	23
18	ISE31A0422	GOPUKRISHNA REDDY	7	20
19	ISE31A0423	GOVIND SOWMYA	20	27
20	ISE31A0424	GUNTI PRAKASHI	18	24
21	ISE31A0425	KADISHERLA ASHWINI	20	21
22	ISE31A0426	KAKULETI JAISURYA SRINIVASA RAO	19	25
23	ISE31A0427	KURMA DATHANAI	17	25
24	ISE31A0428	M RATHIKA	18	20
25	ISE31A0432	MOONIKA THODSAM	20	21
26	ISE31A0433	NANGUNUR VISHNU	20	23
27	ISE31A0435	PABBA SUNDARA CHAITANYA	20	22
28	ISE31A0436	SAI KRISHANTH YADAV	20	23
29	ISE31A0438	PALREDDY NARASIMHA REDDY	18	23
30	ISE31A0439	PASAKAM SAI ABHISEK	19	28

Handwritten signature

*MAHAVEER
INSTITUTE OF SCIENCE & TECHNOLOGY
Bandlaguda, Hyderabad 500 005*

Vysapuri, Bandlaguda Post:Keshavgiri,

Hyderabad-500 005, TELANGANA INDIA
Tel: 040-64596979,8978380692. Fax: 040-24455003
E-mail: e3hod.it@gmail.com.
Website: www.mist.ac.in,

MAHAVEER

INSTITUTE OF SCIENCE & TECHNOLOGY

Approved by AICTE, Affiliated to JNTUH,Hyd.



DEPARTMENT OF ELECTRONICS AND COMMUNICATION ENGINEERING

32	15E31A0440	PEDDOLA NAVEEN REDDY	14	23
32	15E31A0441	PETIGOLI SUCHITHA REDDY	19	29
33	15E31A0442	RAGHAVENDAR PAGIDYALA	20	23
34	15E31A0443	RENKUNTA SAI RAM	13	20
35	15E31A0444	SANA BEGUM	20	27
36	15E31A0445	SAPPIDI KARTHIK REDDY	18	24
7	15E31A0446	SATHI VARUN	17	21
38	15E31A0447	SHAIK AMAIR HUSSAIN	20	25
39	15E31A0448	SUNKARI SRINATHI	18	25
40	15E31A0450	THUPPARTHI SURYA TEJA	20	20
41	15E31A0451	BANALLA DIVYA SAI	19	21
42	15E31A0453	BOMMA PAVANI	17	33
43	14E31A0444	P VINEETH REDDY	18	22
44	13E31A0420	T N Srikanth Babu	20	29
45	14E31A0437	V MADHU TEJA	20	23
46	14E31A0452	T SHASHANK KUMAR REDDY	18	20
47	14E31A0468	D KALYAN	19	27
48	14E31A0464	AZMEERA NIKHIL	18	24
49	14E31A0492	B DEEKSHIT BEJU	14	21
50	14E31A04A0	N HARI PRASAD	20	25
51	15E35A0410	S RAJ KUMAR	18	25

K. Srinivas

PRINCIPAL
MAHAVEER
INSTITUTE OF SCIENCE & TECHNOLOGY
Bandlaguda, Hyd-500 005.

Vyāpuri, Bandlaguda Post:Keshavgiri,

Hyderabad-500 005, TELANGANA INDIA
Tel: 040-64596979,8978380692.Fax: 040-24456003
E-mail: e3hod.it@gmail.com,
Website: www.mist.ac.in,

MAHAVEER

INSTITUTE OF SCIENCE & TECHNOLOGY

Approved by AICTE, Affiliated to JNTUH,Hyd.



DEPARTMENT OF ELECTRONICS AND COMMUNICATION ENGINEERING

SUMMARY REPORT OF Technical Training MS-Office

The purpose of the **MS Word** is to allow the users to type and save documents.

Microsoft **word** is used to save documents.

The documents can be copied to flash drive which serves as an external memory for your computer.

This allows you to use the saved documents conveniently taking with you anywhere.

MS Excel is a spreadsheet programme developed by Microsoft in 1985, with the sole purpose of helping businesses compile all their financial data, yearly credit, and yearly debit sheets.

Fast forward to the future after 31 years, it is now the most commonly used program for creating graphs and pivot tables.

Making your presentation more interesting through the use of multimedia can help to improve the audience's focus.

PowerPoint allows you to use images, audio and video to have a greater visual impact.

These visual and audio cues may also help a presenter be more improvisational and interactive with the audience.

COORDINATOR

Copy to:

1. Department Notice Board
2. Principal for Information
3. Committee Members (Academic)

PRINCIPAL
MAHAVEER
INSTITUTE OF SCIENCE & TECHNOLOGY
BANDLAGUDA, HYD-500 005

Attendance sheet for Technical Trainee MS-Office registered students

S.No	Roll Ticket No	Name of the Candidate	1	2	3	4	5	6	7	8	9	10	11	12	13	14	15	16	17	18	19	20	ATTENDANC 1/200001	
1	1SE31A0403	AKULA SURESHKANDRA	1	2	3	A	4	5	6	7	8	9	10	11	12	13	14	15	16	17	18	19	20	17
2	1SE31A0404	ALLA VENKATA KRISHNA	1	2	3	A	4	5	6	7	8	9	10	11	12	13	14	15	16	17	18	19	20	20
3	1SE31A0405	ALLE VINAY KUMAR	1	2	3	A	4	5	6	7	8	9	10	11	12	13	14	15	16	17	18	19	20	18
4	1SE31A0406	ANNARAM BALAKRISHNA GOUD	1	2	3	A	4	5	6	7	8	9	10	11	12	13	14	15	16	17	18	19	20	20
5	1SE31A0407	B HAKESH	1	2	3	A	4	5	6	7	8	9	10	11	12	13	14	15	16	17	18	19	20	19
6	1SE31A0408	BANDAPATI SPOORTHEE	1	2	3	A	4	5	6	7	8	9	10	11	12	13	14	15	16	17	18	19	20	17
7	1SE31A0409	BHODRYA YAKANNA	1	2	3	A	4	5	6	7	8	9	10	11	12	13	14	15	16	17	18	19	20	18
8	1SE31A0410	BREJDEHABINI	1	2	3	A	4	5	6	7	8	9	10	11	12	13	14	15	16	17	18	19	20	20
9	1SE31A0412	BODDU VASU	1	2	3	A	4	5	6	7	8	9	10	11	12	13	14	15	16	17	18	19	20	20
10	1SE31A0413	BONAGUDU SRINIVAS	1	2	3	A	4	5	6	7	8	9	10	11	12	13	14	15	16	17	18	19	20	20
11	1SE31A0414	C UMA	1	2	3	A	4	5	6	7	8	9	10	11	12	13	14	15	16	17	18	19	20	20
12	1SE31A0415	D SATEJA	1	2	3	A	4	5	6	7	8	9	10	11	12	13	14	15	16	17	18	19	20	18
13	1SE31A0416	DAPRIVENKATESH	1	2	3	A	4	5	6	7	8	9	10	11	12	13	14	15	16	17	18	19	20	19
14	1SE31A0417	DOSADA SOMAYA	1	2	3	A	4	5	6	7	8	9	10	11	12	13	14	15	16	17	18	19	20	20
15	1SE31A0418	EDAM SACHENDANA	1	2	3	A	4	5	6	7	8	9	10	11	12	13	14	15	16	17	18	19	20	20
16	1SE31A0419	GANDLA SACHCHANDRA	1	2	3	A	4	5	6	7	8	9	10	11	12	13	14	15	16	17	18	19	20	20
17	1SE31A0421	GODIM MOUNICA	1	2	3	A	4	5	6	7	8	9	10	11	12	13	14	15	16	17	18	19	20	18
18	1SE31A0422	GOPI KIBARI REDDY	1	2	3	A	4	5	6	7	8	9	10	11	12	13	14	15	16	17	18	19	20	17
19	1SE31A0423	GOVIND SOMAYA	1	2	3	A	4	5	6	7	8	9	10	11	12	13	14	15	16	17	18	19	20	20
20	1SE31A0424	GUNTI NALANH	1	2	3	A	4	5	6	7	8	9	10	11	12	13	14	15	16	17	18	19	20	18
21	1SE31A0425	SADIGEJILA ASHWINI	1	2	3	A	4	5	6	7	8	9	10	11	12	13	14	15	16	17	18	19	20	20
22	1SE31A0426	SANKLETI JASURYA SRINIVASA	1	2	3	A	4	5	6	7	8	9	10	11	12	13	14	15	16	17	18	19	20	19
23	1SE31A0427	KURMA DATILA SAI	1	2	3	A	4	5	6	7	8	9	10	11	12	13	14	15	16	17	18	19	20	17
24	1SE31A0428	M RABHINA	1	2	3	A	4	5	6	7	8	9	10	11	12	13	14	15	16	17	18	19	20	18
25	1SE31A0432	MOUNICA THODSAM	1	2	3	A	4	5	6	7	8	9	10	11	12	13	14	15	16	17	18	19	20	20
26	1SE31A0433	NANJUNUBI VISHNU	1	2	3	A	4	5	6	7	8	9	10	11	12	13	14	15	16	17	18	19	20	20
27	1SE31A0435	PABBA KUNDARA CHAITANYA	1	2	3	A	4	5	6	7	8	9	10	11	12	13	14	15	16	17	18	19	20	20
28	1SE31A0436	SAI SRICANTH YADAV	1	2	3	A	4	5	6	7	8	9	10	11	12	13	14	15	16	17	18	19	20	20
29	1SE31A0438	PAUREDDY NAKASHIMIA REDDY	1	2	3	A	4	5	6	7	8	9	10	11	12	13	14	15	16	17	18	19	20	18
30	1SE31A0439	PASARAM SAI ABHISHEK	1	2	3	A	4	5	6	7	8	9	10	11	12	13	14	15	16	17	18	19	20	19
31	1SE31A0440	PEEDULLA NAVREDDY REDDY	1	2	3	A	4	5	6	7	8	9	10	11	12	13	14	15	16	17	18	19	20	19

Benapally, Hyd-500 006

32	13E31A0441	PULLEGE SUCHITHA REDDY	1	2	3	4	5	6	7	8	9	10	11	12	13	14	15	16	17	18	19	20
33	13E31A0442	BACHAVENDAR JAGDEYALA	1	2	3	4	5	6	7	8	9	10	11	12	13	14	15	16	17	18	19	20
34	13E31A0443	RENIKUNTA SAIKRAM	1	2	3	4	5	6	7	8	9	10	11	12	13	14	15	16	17	18	19	20
35	13E31A0444	SANA BEGLUM	1	2	3	4	5	6	7	8	9	10	11	12	13	14	15	16	17	18	19	20
36	13E31A0445	SAPPIRE KARTHIK REDDY	1	2	3	4	5	6	7	8	9	10	11	12	13	14	15	16	17	18	19	20
37	13E31A0446	SATHI VARUN	1	2	3	4	5	6	7	8	9	10	11	12	13	14	15	16	17	18	19	20
38	13E31A0447	SHAIK AMAR HUSSAIN	1	2	3	4	5	6	7	8	9	10	11	12	13	14	15	16	17	18	19	20
39	13E31A0448	SUNKARI SRINATHI	1	2	3	4	5	6	7	8	9	10	11	12	13	14	15	16	17	18	19	20
40	13E31A0450	THIPPARTHI SUGVA TEJA	1	2	3	4	5	6	7	8	9	10	11	12	13	14	15	16	17	18	19	20
41	13E31A0452	WANALLA DIVYA SAI	1	2	3	4	5	6	7	8	9	10	11	12	13	14	15	16	17	18	19	20
42	13E31A0455	BOMMA PAVANI	1	2	3	4	5	6	7	8	9	10	11	12	13	14	15	16	17	18	19	20
43	14E31A0444	P VINIETHI REDDY	1	2	3	4	5	6	7	8	9	10	11	12	13	14	15	16	17	18	19	20
44	13E31A0420	J N SollandBaba	1	2	3	4	5	6	7	8	9	10	11	12	13	14	15	16	17	18	19	20
45	14E31A0457	V MADHULTEJA	1	2	3	4	5	6	7	8	9	10	11	12	13	14	15	16	17	18	19	20
46	14E31A0455	T SRIVASTAV KUMAR REDDY	1	2	3	4	5	6	7	8	9	10	11	12	13	14	15	16	17	18	19	20
47	14E31A0468	D KALYAN	1	2	3	4	5	6	7	8	9	10	11	12	13	14	15	16	17	18	19	20
48	14E31A0464	AZMEELA NIKHIL	1	2	3	4	5	6	7	8	9	10	11	12	13	14	15	16	17	18	19	20
49	14E31A0462	S DEEKSHIT REDU	1	2	3	4	5	6	7	8	9	10	11	12	13	14	15	16	17	18	19	20
50	14E31A0440	N HARI PRASAD	1	2	3	4	5	6	7	8	9	10	11	12	13	14	15	16	17	18	19	20
51	15E35A0410	S RAJ KUMAR	1	2	3	4	5	6	7	8	9	10	11	12	13	14	15	16	17	18	19	20

Co-ordinator

HOD, ECE Dept

PRINCIPAL
MAHAVEER
INSTITUTE OF SCIENCE & TECHNOLOGY
Bansal Nagar, Hyd-500 005.

Vysapuri Bandlaguda Post:Keshavgi,

MAHAVEER

INSTITUTE OF SCIENCE & TECHNOLOGY
Approved by AICTE, Affiliated to JNTUH,Hyd



Hyderabad-500 005, TELANGANA INDIA
Tel: 040-64596979,8978380692,Fax: 040-24455003
E-mail: e3hod.it@gmail.com
Website: www.mist.ac.in,

DEPARTMENT OF ELECTRONICS AND COMMUNICATION ENGINEERING

Date: 02-01-2017

CIRCULAR

Technical Trainings for **Cloud computing** III & IV B. Tech students are starting from **21-01-2017** onwards. All the students III year ,B.Tech I Semester should attend.

Design and development of curriculum for add-on courses :

Faculty Names: 1. Prof. B. Visweswara Rao
2. Dr. V. Gunashekhar Reddy
3. Mr. Ch. Sandeep Kumar

HOD, ECE

Cc: Principal for information
: Coordinator to inform the students
: Notice board & department File.



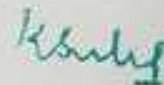

PRINCIPAL
MAHAVEER
INSTITUTE OF SCIENCE & TECHNOLOGY
Bandlaguda, Hyd-500 005.

Vysapuri, Bandlaguda Post:Keshavgi,

MAHAVEER

INSTITUTE OF SCIENCE & TECHNOLOGY

Approved by AICTE, Affiliated to JNTUH,Hyd.



Hyderabad-500 005, TELANGANA INDIA
Tel: 040-64596979,8978380692 Fax: 040-24455003
E-mail: e3hod.it@gmail.com,
Website: www.mist.ac.in,

DEPARTMENT OF ELECTRONICS AND COMMUNICATION ENGINEERING

SYLLABUS FOR Cloud computing

SNO	TOPIC COVERED	DURATION
1	Introduction to Cloud Computing	3
2	Adopting the Cloud	3
3	Exploiting Software as a Service (SaaS)	3
4	Delivering Platform as a Service (PaaS)	3
5	Deploying Infrastructure as a Service (IaaS)	3
6	Building a Business Case	3
7	Migrating to the Cloud	3
8	Introduction to Hadoop	3
9	Hadoop Architecture, Distributed Storage & YARN	3
10	Data Ingestion into Big Data Systems	3
11	Distributed Processing	3
12	Apache Hive	3
13	NoSQL Data bases-HBase	3

HOD-ECE



PRINCIPAL
MAHAVEER
INSTITUTE OF SCIENCE & TECHNOLOGY
Bandlaguda, Hyd-500 005

Vysapuri, Bandlaguda Post:Keshavgi,

Hyderabad-500 005, TELANGANA INDIA
Tel: 040-64596979,8978380692 Fax: 040-24455003
E-mail: e3hod.it@gmail.com
Website: www.mist.ac.in,

MAHAVEER

INSTITUTE OF SCIENCE & TECHNOLOGY
Approved by AICTE, Affiliated to JNTUH,Hyd



DEPARTMENT OF ELECTRONICS AND COMMUNICATION ENGINEERING

LIST OF REGISTERED STUDENTS FOR Cloud computing

S.No	Hall Ticket No	Name of the Candidate
1	15E31A0403	AKULA SHUCHENDRA
2	15E31A0404	ALLA VENKATA KRISHNA YAMSHI
3	15E31A0405	ALLE VINAY KUMAR
4	15E31A0406	ANNARAM BALAKRISHNA GOUD
5	15E31A0407	BRAKESH
6	15E31A0408	BANDAPELLI SPOORTHI
7	15E31A0409	BHOKYA YAKANNA
8	15E31A0410	BIRUDU HARINI
9	15E31A0412	BODDU VASU
10	15E31A0413	BONAGIRE SHANTYAS
11	15E31A0414	CUMA
12	15E31A0415	D SAITEJA
13	15E31A0416	DAPPU VENKATESH
14	15E31A0417	DORADA SOMYA
15	15E31A0418	EDAMS SICHANDANA
16	15E31A0419	GANDLA SAICHANDRA
17	15E31A0421	GEETHA MOLUNKA
18	15E31A0422	GOPU KIRAN REDDY
19	15E31A0423	GOVIND SOMAYA
20	15E31A0424	GUNTI PRAKASH
21	15E31A0425	KADICHERLA ASHWINI
22	15E31A0426	KAKILETI JAISURYA SRINIVASA RAO
23	15E31A0427	KURMA DATHA SAI
24	15E31A0428	M RADHIKA
25	15E31A0432	MOUNIKA THEOSAM
26	15E31A0433	NANUNURIVISHNU
27	15E31A0435	PABBA SUNDARA CHAITANYA
28	15E31A0436	SAI SRKANTH YADAV
29	15E31A0438	PALREDDY NARASIMHA REDDY
30	15E31A0439	PASARAM SAI ARBIBEK

Khanh

PRINCIPAL
MAHAVEER
INSTITUTE OF SCIENCE & TECHNOLOGY
Bandlaguda, Hyd - 500 005

Vysapuri, Bandlaguda Post, Keshavgi.

MAHAVEER

INSTITUTE OF SCIENCE & TECHNOLOGY

Approved by AICTE, Affiliated to JNTU-Hyd.



Hyderabad-500 005, TELANGANA INDIA
Tel: 040-64596979, 8978380692 Fax: 040-24455093
E-mail: s3hod.it@gmail.com
Website: www.mist.ac.in

DEPARTMENT OF ELECTRONICS AND COMMUNICATION ENGINEERING

31	15E11A0440	PEERKOLLA NAVJEN REDDY
32	15E11A0441	PULLURU RUCHITJA REDDY
33	15E11A0442	RAGHAYENDRA PADIYALA
34	15E11A0443	RONIKUNTA BARAM
35	15E11A0444	SANA BEGUM
36	15E11A0445	SAJJIDI KARTHIK REDDY
7	15E11A0446	SATHE VARUN
38	15E11A0447	SEKAR AMAR SUBBAM
39	15E11A0448	SUNDEAR SINDHATH
40	15E11A0450	THIPPARTHI SUREYA TIJA
41	15E11A0453	WANALEA DIVYA SAI
42	15E11A0455	SRINAMA PAYANI
43	15E11A0444	P.VRISHATH REDDY
44	15E11A0420	JN SivaPrasad
45	14E11A0437	V.MADHU TIJA
46	14E11A0455	V.SHARMAN KUMAR REDDY
47	14E11A0468	D.KALYAN
48	14E11A0464	AZMEERA NIKHIL
49	14E11A0492	S.DEEKSHIT REJU
50	14E11A0450	N HARI PRASAD
51	15E11A0419	SUKA KUMAR

Handwritten signature

PRINCIPAL
MAHAVEER
INSTITUTE OF SCIENCE & TECHNOLOGY
Bandlaguda, Hyd-500 005.

Vysapuri, Bandlaguda Post:Keshavgiri,

Hyderabad-500 005, TELANGANA INDIA
Tel: 040-64596979,8978380692 Fax: 040-24455003
E-mail: e3hod.it@gmail.com,
Website: www.mist.ac.in,

MAHAVEER

INSTITUTE OF SCIENCE & TECHNOLOGY

Approved by AICTE, Affiliated to JNTUH,Hyd.



DEPARTMENT OF ELECTRONICS AND COMMUNICATION ENGINEERING

Cloud computing QUESTION PAPER

Duration: 120

Minutes 10 X 3 = 300 Marks

Answer the following all questions. Each question carries 2 marks.

1. What is cloud computing?
2. What are the types of cloud?
3. What are the benefits of cloud computing?
4. Is the cloud secure?
5. How do I develop a cloud strategy?
6. What is Hadoop and its components.
7. What are HDFS and YARN?
8. Compare HDFS with Network Attached Storage (NAS).
9. List the difference between Hadoop 1 and Hadoop 2.
10. What happens when two clients try to access the same file in the HDFS?

HOD-EC

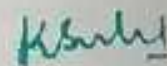

PRINCIPAL
MAHAVEER
INSTITUTE OF SCIENCE & TECHNOLOGY
Bandlaguda, Hyd-500 005.

Vysapuri, Bandlaguda Post:Keshavgi,ri,

Hyderabad-500 005, TELANGANA INDIA
Tel: 040-64696979,8978380692, Fax: 040-24455003
E-mail: e3hod.it@gmail.com,
Website: www.mist.ac.in,

MAHAVEER

INSTITUTE OF SCIENCE & TECHNOLOGY
Approved by AICTE, Affiliated to JNTUH,Hyd.



DEPARTMENT OF INFORMATION TECHNOLOGY

RESULT SHEET FOR Cloud computing REGISTERED STUDENTS

S.No	Roll Ticket No	Name of the Candidate	ATTENDANCE (20hrs)	Marks Obtained(50)
1	11EE1A0403	AKULA SHUCHENDRA	17	23
2	11EE1A0404	ALLA VENKATA KRISHNA VAMSHI	20	29
3	11EE1A0405	ALLE VINAY KUMAR	18	23
4	11EE1A0406	ANNARAM BALAKRISHNA GOUD	20	26
5	11EE1A0407	B RAKESH	19	27
6	11EE1A0408	BANGAPELLI SPOOR THI	17	24
7	11EE1A0409	BHICORVA YAKANNA	18	25
8	11EE1A0410	BREDDU HARINI	20	25
9	11EE1A0412	BODDU VASU	20	25
10	11EE1A0413	BONAGIRI SRINIVAS	20	20
11	11EE1A0414	C UMA	20	21
12	11EE1A0415	D SAITEJA	18	23
13	11EE1A0416	DAPPU VENKATESH	19	22
14	11EE1A0417	DOSADA SOWMYA	20	23
15	11EE1A0418	EDAM SAICHANDANA	18	23
16	11EE1A0419	GANDLA SAICHANDRA	20	29
17	11EE1A0421	GOJEM MOUNIKA	18	23
18	11EE1A0422	GOPU XIRAN REDDY	17	20
19	11EE1A0423	GOVIND SOWMYA	20	27
20	11EE1A0424	GUNTI PRARASHI	18	24
21	11EE1A0425	RADICHEMLA ASHWINI	20	21
22	11EE1A0426	KAKILETI JAISURYA SRINIVASA RAO	19	25
23	11EE1A0427	KURMA DATHA SAI	17	25
24	11EE1A0428	M RADHIKA	18	20
25	11EE1A0431	MOUNIKA THODSAM	20	21
26	11EE1A0433	MANGUNURI VISHNU	20	23
27	11EE1A0435	PABBA SUNDARA CHAITANYA	20	22
28	11EE1A0436	SAI SRIKANTH YADAV	20	23
29	11EE1A0438	FALREDDY NARASIMHA REDDY	11	23
30	11EE1A0439	PASADAM SAI ABHIRAM	11	29

K. K. K.

PRINCIPAL
MAHAVEER
INSTITUTE OF SCIENCE & TECHNOLOGY
Bandlaguda, Hyd-500 005

Vysapuri, Bandlaguda Post:Keshavgiri,

Hyderabad-500 005, TELANGANA INDIA

Tel: 040-64596979,8978380692 Fax: 040-24455003

E-mail: e3hod.it@gmail.com.

Website: www.mist.ac.in,

MAHAVEER

INSTITUTE OF SCIENCE & TECHNOLOGY

Approved by AICTE, Affiliated to JNTUH,Hyd.



DEPARTMENT OF ELECTRONICS AND COMMUNICATION ENGINEERING

32	ISE31A0440	PEDDOLA NAVEEN REDDY	18	23
32	ISE31A0441	PULUGU SUCHETHA REDDY	19	20
33	ISE31A0442	RAGHAVENDAR PAGIDYALA	20	23
34	ISE31A0443	RENIKUNYA NABHAM	18	20
35	ISE31A0444	SANA BEGUM	20	27
36	ISE31A0445	SAPPIDI KARTHIK REDDY	18	24
7	ISE31A0446	SATHI VARUN	17	21
38	ISE31A0447	SHAIK AMAIR HUSSAIN	20	25
39	ISE31A0448	SUNKARI SRINATH	18	25
40	ISE31A0450	THEPPARETHI SURYA TEJA	20	20
41	ISE31A0453	BANALLA DIVYA SAI	19	21
42	ISE31A0455	BROMMA PAVANI	17	23
43	ISE31A0444	P VINEETH REDDY	18	22
44	ISE31A0420	J N Sekantibabu	20	29
45	ISE31A0457	V MADHU TEJA	20	23
46	ISE31A0455	T BHASHANK KUMAR REDDY	18	20
47	ISE31A0468	D K AJAYAN	19	27
48	ISE31A0464	AZMEERA NIKHIL	18	24
49	ISE31A0492	S DEEKSHIT REJU	19	21
50	ISE31A04A0	N HARI PRASAD	20	25
51	ISE31A0410	S RAJ KUMAR	18	25

K. Anil

PRINCIPAL
M. AVEER
INSTITUTE OF SCIENCE & TECHNOLOGY
Bandlaguda, Hy-500 005.

Vysapuri, Bandlaguda Post:Keshavgiri,

MAHAVEER

INSTITUTE OF SCIENCE & TECHNOLOGY

Approved by AICTE, Affiliated to JNTUH,Hyd



Hyderabad-500 005, TELANGANA INDIA

Tel: 040-64596979,8978380692 Fax: 040-24450003

E-mail: e3hod.it@gmail.com

Website: www.mist.ac.in

DEPARTMENT OF ELECTRONICS AND COMMUNICATION ENGINEERING

SUMMARY REPORT OF Cloud computing

Cloud computing is perhaps the most flamboyant technological innovation of the 21st century.

This is because it has seen the fastest adoption into the mainstream than any other technology in the domain.

This adoption has been fueled mainly by the ever-increasing number of smart phones and mobile devices that can access the internet.

Cloud computing is not just for organizations and businesses; it's also useful for the average person as well.

It enables us to run software programs without installing them on our computers; it enables us to store and access our multimedia content via the internet, it enables us to develop and test programs without necessarily having servers and so on.

Hadoop is an open source platform that provides excellent data management provision.

It is a framework that supports the processing of large data sets in a distributed computing environment.

It is designed to expand from single servers to thousands of machines, each providing computation and storage.

Its distributed file system facilitates rapid data transfer rates among nodes and allows the system to continue operating uninterrupted in case of a node failure, which minimizes the risk of catastrophic system failure, even if a significant number of nodes become out of action.

COORDINATOR

Copy to:

1. Department Notice Board
2. Principal for Information
3. Committee Members (Academic)

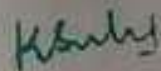

PRINCIPAL
MAHAVEER
INSTITUTE OF SCIENCE & TECHNOLOGY
Bandlaguda, Hyderabad-500 005

Attendance sheet for CLOUD COMPUTING registered students:

S.no.	Roll Ticket No	Name of the Candidate	1	2	3	4	5	6	7	8	9	10	11	12	13	14	15	16	17	18	19	20	ATTENDANCE SHEET
1	15E31A0403	AKULIA SHEERJENDOLA	1	2	3	4	5	6	7	8	9	10	11	12	13	14	15	16	17	18	19	20	ATTENDANCE SHEET
2	15E31A0404	ALLA VENKATA KRISHNA VAMSHI	1	2	3	4	5	6	7	8	9	10	11	12	13	14	15	16	17	18	19	20	ATTENDANCE SHEET
3	15E31A0405	ALLE VINAY KUMAR	1	2	3	4	5	6	7	8	9	10	11	12	13	14	15	16	17	18	19	20	ATTENDANCE SHEET
4	15E31A0406	ANNABAM BALAKRISHNA DODD	1	2	3	4	5	6	7	8	9	10	11	12	13	14	15	16	17	18	19	20	ATTENDANCE SHEET
5	15E31A0407	B. RAJESH	1	2	3	4	5	6	7	8	9	10	11	12	13	14	15	16	17	18	19	20	ATTENDANCE SHEET
6	15E31A0408	BANDAPALLI SPOURTHI	1	2	3	4	5	6	7	8	9	10	11	12	13	14	15	16	17	18	19	20	ATTENDANCE SHEET
7	15E31A0409	BHOOKYA TANASIMA	1	2	3	4	5	6	7	8	9	10	11	12	13	14	15	16	17	18	19	20	ATTENDANCE SHEET
8	15E31A0410	BIRUDU HARINI	1	2	3	4	5	6	7	8	9	10	11	12	13	14	15	16	17	18	19	20	ATTENDANCE SHEET
9	15E31A0412	BODDU VASU	1	2	3	4	5	6	7	8	9	10	11	12	13	14	15	16	17	18	19	20	ATTENDANCE SHEET
10	15E31A0413	BONAGIRI SRIKAVAS	1	2	3	4	5	6	7	8	9	10	11	12	13	14	15	16	17	18	19	20	ATTENDANCE SHEET
11	15E31A0414	C. IJBA	1	2	3	4	5	6	7	8	9	10	11	12	13	14	15	16	17	18	19	20	ATTENDANCE SHEET
12	15E31A0415	D. SATEJA	1	2	3	4	5	6	7	8	9	10	11	12	13	14	15	16	17	18	19	20	ATTENDANCE SHEET
13	15E31A0416	DAPPU VENKATESH	1	2	3	4	5	6	7	8	9	10	11	12	13	14	15	16	17	18	19	20	ATTENDANCE SHEET
14	15E31A0417	DODADA SWAMYA	1	2	3	4	5	6	7	8	9	10	11	12	13	14	15	16	17	18	19	20	ATTENDANCE SHEET
15	15E31A0418	EDAN SAICHANDANA	1	2	3	4	5	6	7	8	9	10	11	12	13	14	15	16	17	18	19	20	ATTENDANCE SHEET
16	15E31A0419	GANDELA SAICHANDANA	1	2	3	4	5	6	7	8	9	10	11	12	13	14	15	16	17	18	19	20	ATTENDANCE SHEET
17	15E31A0421	GODEM MURRIBA	1	2	3	4	5	6	7	8	9	10	11	12	13	14	15	16	17	18	19	20	ATTENDANCE SHEET
18	15E31A0422	GOPI KIRAN REDDY	1	2	3	4	5	6	7	8	9	10	11	12	13	14	15	16	17	18	19	20	ATTENDANCE SHEET
19	15E31A0423	GOVIND SOWMYA	1	2	3	4	5	6	7	8	9	10	11	12	13	14	15	16	17	18	19	20	ATTENDANCE SHEET
20	15E31A0424	GUNTI PRAKASH	1	2	3	4	5	6	7	8	9	10	11	12	13	14	15	16	17	18	19	20	ATTENDANCE SHEET
21	15E31A0425	KADURIBILLA ASHWINI	1	2	3	4	5	6	7	8	9	10	11	12	13	14	15	16	17	18	19	20	ATTENDANCE SHEET
22	15E31A0426	KARLETTI JASURVA SRIKAVAS RAO	1	2	3	4	5	6	7	8	9	10	11	12	13	14	15	16	17	18	19	20	ATTENDANCE SHEET
23	15E31A0427	KURBAN DATTIA SAI	1	2	3	4	5	6	7	8	9	10	11	12	13	14	15	16	17	18	19	20	ATTENDANCE SHEET
24	15E31A0428	M. RAJIBIKA	1	2	3	4	5	6	7	8	9	10	11	12	13	14	15	16	17	18	19	20	ATTENDANCE SHEET
25	15E31A0432	MOUNISA THOOSAM	1	2	3	4	5	6	7	8	9	10	11	12	13	14	15	16	17	18	19	20	ATTENDANCE SHEET
26	15E31A0433	MANGI NURE VIRENSU	1	2	3	4	5	6	7	8	9	10	11	12	13	14	15	16	17	18	19	20	ATTENDANCE SHEET
27	15E31A0435	PABBA SUNDARA CHAITANYA	1	2	3	4	5	6	7	8	9	10	11	12	13	14	15	16	17	18	19	20	ATTENDANCE SHEET
28	15E31A0436	SAI SRIGANTH YADAV	1	2	3	4	5	6	7	8	9	10	11	12	13	14	15	16	17	18	19	20	ATTENDANCE SHEET
29	15E31A0438	PAJUREDDY NARASIMHA REDDY	1	2	3	4	5	6	7	8	9	10	11	12	13	14	15	16	17	18	19	20	ATTENDANCE SHEET
30	15E31A0439	PALAKAM SAI ABHIRAM	1	2	3	4	5	6	7	8	9	10	11	12	13	14	15	16	17	18	19	20	ATTENDANCE SHEET

31	19E31A0443	WISWIKULA NAVEEN REDDY	1	2	A	3	4	5	6	7	8	9	10	11	12	13	14	15	16	17	18
32	19E31A0441	PULUGU ECHITHA REDDY	1	2	3	4	5	6	7	8	9	10	11	12	13	14	15	16	17	18	19
33	19E31A0442	KAOHA VENDOR PAGIDYALA	1	2	3	4	5	6	7	8	9	10	11	12	13	14	15	16	17	18	19
34	19E31A0443	RENKUNTA SURESH	1	2	3	4	5	6	7	8	9	10	11	12	13	14	15	16	17	18	19
35	19E31A0444	SANA BEGUM	1	2	3	4	5	6	7	8	9	10	11	12	13	14	15	16	17	18	19
36	19E31A0445	SAJJIDI KARTHIC REDDY	1	2	3	4	5	6	7	8	9	10	11	12	13	14	15	16	17	18	19
37	19E31A0446	SATHI VARUN	1	2	3	4	5	6	7	8	9	10	11	12	13	14	15	16	17	18	19
38	19E31A0447	SHAK ANAJE HUSSAIN	1	2	3	4	5	6	7	8	9	10	11	12	13	14	15	16	17	18	19
39	19E31A0448	SANKARI SORNATH	1	2	3	4	5	6	7	8	9	10	11	12	13	14	15	16	17	18	19
40	19E31A0449	THIRUPATHI SURYA TEJA	1	2	3	4	5	6	7	8	9	10	11	12	13	14	15	16	17	18	19
41	19E31A0451	BANALLA DIVYA SAI	1	2	3	4	5	6	7	8	9	10	11	12	13	14	15	16	17	18	19
42	19E31A0453	CHIRMA PAVAN	1	2	3	4	5	6	7	8	9	10	11	12	13	14	15	16	17	18	19
43	19E31A0444	P VINETH REDDY	1	2	3	4	5	6	7	8	9	10	11	12	13	14	15	16	17	18	19
44	19E31A0429	J N Srinanth Babu	1	2	3	4	5	6	7	8	9	10	11	12	13	14	15	16	17	18	19
45	19E31A0457	V MADHU TEJA	1	2	3	4	5	6	7	8	9	10	11	12	13	14	15	16	17	18	19
46	19E31A0455	T SHASHANK KUMAR REDDY	1	2	3	4	5	6	7	8	9	10	11	12	13	14	15	16	17	18	19
47	19E31A0444	D KALYAN	1	2	3	4	5	6	7	8	9	10	11	12	13	14	15	16	17	18	19
48	19E31A0444	AJMEERA NIGHEL	1	2	3	4	5	6	7	8	9	10	11	12	13	14	15	16	17	18	19
49	19E31A0452	SURESHITH REDY	1	2	3	4	5	6	7	8	9	10	11	12	13	14	15	16	17	18	19
50	19E31A0440	N RAJESH PRASAD	1	2	3	4	5	6	7	8	9	10	11	12	13	14	15	16	17	18	19
51	19E31A0449	S RAJ KUMAR	1	2	3	4	5	6	7	8	9	10	11	12	13	14	15	16	17	18	19

Dr. J. Mahaveer
HOD, ECE Dept

Mahaveer

PRINCIPAL
MAHAVEER
INSTITUTE OF SCIENCES & TECHNOLOGY
Guntur, Andhra Pradesh, Hyderabad - 500 088.

S. N. Srinivas
Co-ordinator

Vysapuri, Bandlaguda Post:Keshavgiri.

Hyderabad-500 005, TELANGANA INDIA
Tel: 040-64596979,8978380692,Fax: 040-24455003
E-mail: e3hod.cse@gmail.com.
Website: www.mist.ac.in.

MAHAVEER

INSTITUTE OF SCIENCE & TECHNOLOGY

Approved by AICTE, Affiliated to JNTUH,Hyd.



DEPARTMENT OF COMPUTER SCIENCE AND ENGINEERING

Date: 03-09-2018

CIRCULAR

Technical Trainings for III & IV B. Tech students are starting from 10-09-2018 onwards. All HODs and placements coordinators have to manage the trainings and ensure 95% attendance all through the sessions.

All mentors need to send the compiled feedback report to HOD at e3hod@gmail.com daily. Mentors are advised to take care of FNR (Students not participating in training).

Agenda: **PC Hardware and Networking**

HOD CSE

PRINCIPAL
MAHAVEER
INSTITUTE OF SCIENCE & TECHNOLOGY
Bandlaguda, Hyderabad-500 005.

Vysapuri, Bandlaguda Post:Keshavgiri,

MAHAVEER

INSTITUTE OF SCIENCE & TECHNOLOGY

Approved by AICTE, Affiliated to JNTUH,Hyd.



Hyderabad-500 005, TELANGANA INDIA

Tel: 040-84596979,8978380692 Fax: 040-24455003

E-mail: g3hod.cse@gmail.com

Website: www.mist.ac.in

DEPARTMENT OF COMPUTER SCIENCE AND ENGINEERING

SYLLABUS FOR PC Hardware and Networking

SNO	TOPIC COVERED	DURATION
1	Introduction about computer	2
2	Basic Networking concepts	6
3	Introduction to various networking devices	4
4	Inside the PC	4
5	Network basic and configuration	4
6	Introduction to servers and network security	10

HOD-CSE 

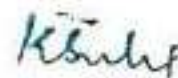

PRINCIPAL
MAHAVEER
INSTITUTE OF SCIENCE & TECHNOLOGY
Bandlaguda, Hyd-500 005.

Vysapuri, Bandlaguda Post:Keshavgirl,

Hyderabad-500 005, TELANGANA INDIA
Tel: 040-64596979,8978380692. Fax: 040-24455003
E-mail: e3hod.cse@gmail.com,
Website: www.mist.ac.in,

MAHAVEER

INSTITUTE OF SCIENCE & TECHNOLOGY
Approved by AICTE. Affiliated to JNTUH,Hyd.



DEPARTMENT OF COMPUTER SCIENCE AND ENGINEERING

LIST OF REGISTERED STUDENTS FOR PC Hardware and Networking

SNO	HALL TICKET NO	NAME OF THE STUDENT
1	14E31A0501	ADUNUTULA VISHNU PREETH REDDY
2	14E31A0502	AENUGU RASAGNYA
3	14E31A0503	AKULA NIHARIKA
4	14E31A0504	ALLE AKHILENDRA SATYANARAYANA
5	14E31A0505	AMIR SOHAIL
6	14E31A0507	ANUMULA VINOD ABHISHEK
7	14E31A0508	ASTAM PRANAY REDDY
8	14E31A0511	CHENNAPPAGARI AISHWARYA
9	14E31A0513	DONGRE JAIPAL
10	14E31A0514	EDUKOJU ANUPRIYA
11	14E31A0517	GADDALAPALI SRINIVAS
12	14E31A0518	GAJARLA KARUNASAGAR
13	14E31A0519	GAJJALA DHRUVA MANASA
14	14E31A0520	GILLA RAJESH
15	14E31A0521	YEDULAPURAM SAHITHI
16	14E31A0522	GUMMALLA SAI NISHANTH REDDY
17	14E31A0523	GUNUPURU ROJA RANI
18	14E31A0524	ISLAVATH KISHORE
19	14E31A0526	KHUSHBHU DONGARE
20	14E31A0527	KULKARNI SANKIRTH

K. S. S. S.

PRINCIPAL

MAHAVEER
INSTITUTE OF SCIENCE & TECHNOLOGY
Bandlaguda, Hyderabad-500 005.

Vysapuri, Bandlaguda Post, Keshavgi,

Hyderabad-500 005, TELANGANA INDIA
Tel: 040-64596979, 8978330692 Fax: 040-24455003
E-mail: g3hod.cse@gmail.com,
Website: www.mist.ac.in,

MAHAVEER

INSTITUTE OF SCIENCE & TECHNOLOGY

Approved by AICTE, Affiliated to JNTUH, Hyd.



DEPARTMENT OF COMPUTER SCIENCE AND ENGINEERING

21	14E31A0528	KUNA SAI SANGEETHA
22	14E31A0529	LOKANADAM DEVI
23	14E31A0530	M A MUJADID MOHIUDDIN
24	14E31A0533	MEDI NITHIN
25	15E31A0501	ABHISHEK KUMAR GAUTAM
26	15E31A0502	AFRIN
27	15E31A0503	ALLA VANAJA CHOWDARI
28	15E31A0504	AMANCHERLA GAYATHRI SUSHMA
29	15E31A0505	ANNARAPU KSHETHRA
30	15E31A0506	ARVA SHASHANK
31	15E31A0507	BADAM SHARATH KUMAR
32	15E31A0508	BAGGARI SIVA NARAYANA REDDY
33	15E31A0509	BEJAVADA KRISHNA SAI
34	15E31A0510	BELUGUPPA H S LAHARI
35	15E31A0512	BUNNE VAMSHI KRISHNA
36	15E31A0514	CHITTIMALLA SAIRAM
37	15E31A0515	D ESHWAR PRASAD
38	15E31A0516	DHYADE SHAILAJA
39	15E31A0517	DIDYALA KIRAN KUMAR
40	15E31A0518	NAKKA CHAITANYA
41	15E31A0519	G MAHESHWARI

K. K. K.

PRINCIPAL

M. S. S. S. S.
MAHAVEER INSTITUTE OF SCIENCE & TECHNOLOGY
Bandlaguda, Hyd-500 005

Vysapuri, Bandlaguda Post:Keshavgiri,

Hyderabad-500 005, TELANGANA INDIA
Tel: 040-64596979,8978380692 Fax: 040-24455003
E-mail: e3hod.cse@gmail.com,
Website: www.mist.ac.in,

MAHAVEER

INSTITUTE OF TECHNOLOGY & TRAINING
Approved by AICTE, Affiliated to JNTUH,Hyd



DEPARTMENT OF COMPUTER SCIENCE AND ENGINEERING

42	15E31A0520	GOLUKAR SUSHMA
43	15E31A0521	GUDURU SANKEERTH
44	15E31A0523	GURRAM RAJESH
45	15E31A0527	KARIGIRI RAMYA
46	15E31A0528	KOMANDLA ANILA REDDY
47	15E31A0530	L NAVYATHA
48	15E31A0531	M VARUN KUMAR REDDY
49	15E31A0537	NAGUBANDI SAIRAM PRUDHVI
50	15E31A0542	NIMMALA VINAYKUMAR
51	15E31A0543	NITISH REDDY K
52	15E31A0544	P VAMSHI KRISHNA
53	15E31A0545	PAYAPULA MAHENDAR
54	15E31A0546	PINJALA DHANRAJ SAGAR

Handwritten signature

PRINCIPAL
DEPARTMENT OF
COMPUTER SCIENCE & TECHNOLOGY
Bandlaguda Post-500 005

Vysapuri, Bandlaguda Post:Keshavgiri,

Hyderabad-500 005, TELANGANA INDIA

Tel: 040-64596979,8978380692.Fax: 040-24455003

E-mail: e3hod.cse@gmail.com,

Website: www.mist.ac.in,

MAHAVEER

INSTITUTE OF TECHNOLOGY & MANAGEMENT

Approved by AICTE, Affiliated to JNTUH,Hyd;



DEPARTMENT OF COMPUTER SCIENCE AND ENGINEERING

PC Hardware and Networking QUESTION PAPER

Duration: 120 Minutes

10 X 2 = 20 Marks

Answer the following all questions. Each question carries 2 marks.

1. What Is A Computer?
2. What Are The Different Functions Of A Computer?
3. How A Minicomputer Different From A Mainframe?
4. What Is Super Computer?
5. Differentiate Input and Output Device?
6. What Is A Storage Device? What Is The Common Classification?
7. What Do You Mean By A Processing Device? What Are The Various Types Of Processing Devices?
8. What Is An Interface?
9. What is a network?
10. What are the different types of networks?

HOD-CSE

PRINCIPAL
MAHAVEER
INSTITUTE OF TECHNOLOGY & MANAGEMENT
Bandlaguda, Hyd-500 005.

Vysapuri, Bandlaguda Post:Keshavgi,

Hyderabad-500 005, TELANGANA INDIA

Tel: 040-64596979,8978380692.Fax: 040-24455003

E-mail: e3hod.cse@gmail.com,

Website: www.mist.ac.in,

MAHAVEER

INSTITUTE OF LIBERAL & TECHNOLOGY

Approved by AICTE, Affiliated to JNTUH,Hyd.



DEPARTMENT OF COMPUTER SCIENCE AND ENGINEERING

RESULT SHEET PC Hardware and Networking REGISTERED STUDENTS

SNO	HALL TICKET NO	NAME OF THE STUDENT	MARKS (20)	RESULT
1	14E31A0501	ADUNUTULA VISHNU PREETH REDDY	20	PASS
2	14E31A0502	AENUGU RASAGNYA	19	PASS
3	14E31A0503	AKULA NIHARIKA	20	PASS
4	14E31A0504	ALLE AKHILENDRA SATYANARAYANA	18	PASS
5	14E31A0505	AMIR SOHAIL	20	PASS
6	14E31A0507	ANUMULA VINOD ABHISHEK	20	PASS
7	14E31A0508	ASTAM PRANAY REDDY	16	PASS
8	14E31A0511	CHENNAPPAGARI AISHWARYA	20	PASS
9	14E31A0513	DONGRE JAIPAL	20	PASS
10	14E31A0514	EDUKOJU ANUPRIYA	17	PASS
11	14E31A0517	GADDALAPALLI SRINIVAS	20	PASS
12	14E31A0518	GAJARLA KARUNASAGAR	20	PASS
13	14E31A0519	GAJALA DHRUVA MANASA	16	PASS
14	14E31A0520	GILLA RAJESH	20	PASS
15	14E31A0521	YEDULAPURAM SAHITHI	20	PASS
16	14E31A0522	GUMMALLA SAI NISHANTH REDDY	18	PASS
17	14E31A0523	GUNUPURU ROJA RANI	20	PASS
18	14E31A0524	ISLAVATH KISHORE	19	PASS
19	14E31A0526	KHUSHBHU DONGARE	20	PASS

K. Srinivas
PRINCIPAL

14E31A0527
14E31A0528
14E31A0529
14E31A0530
14E31A0531
14E31A0532
14E31A0533
14E31A0534
14E31A0535
14E31A0536
14E31A0537
14E31A0538
14E31A0539
14E31A0540
14E31A0541
14E31A0542
14E31A0543
14E31A0544
14E31A0545
14E31A0546
14E31A0547
14E31A0548
14E31A0549
14E31A0550
14E31A0551
14E31A0552
14E31A0553
14E31A0554
14E31A0555
14E31A0556
14E31A0557
14E31A0558
14E31A0559
14E31A0560
14E31A0561
14E31A0562
14E31A0563
14E31A0564
14E31A0565
14E31A0566
14E31A0567
14E31A0568
14E31A0569
14E31A0570
14E31A0571
14E31A0572
14E31A0573
14E31A0574
14E31A0575
14E31A0576
14E31A0577
14E31A0578
14E31A0579
14E31A0580
14E31A0581
14E31A0582
14E31A0583
14E31A0584
14E31A0585
14E31A0586
14E31A0587
14E31A0588
14E31A0589
14E31A0590
14E31A0591
14E31A0592
14E31A0593
14E31A0594
14E31A0595
14E31A0596
14E31A0597
14E31A0598
14E31A0599
14E31A0600

Vysapuri, Bandlaguda Post:Keshavgiri.

Hyderabad-500 005, TELANGANA INDIA
Tel: 040-64596979,8978380692.Fax: 040-24455003
E-mail: e3hod_cse@gmail.com,
Website: www.mist.ac.in,

MAHAVEER

UNIVERSITY OF SCIENCE & TECHNOLOGY

Approved by AICTE, Affiliated to JNTUH,Hyd.



DEPARTMENT OF COMPUTER SCIENCE AND ENGINEERING

20	14E31A0527	KULKARNI SANKIRTH	18	PASS
21	14E31A0528	KUNA SAI SANGEETHA	20	PASS
22	14E31A0529	LOKANADAM DEVI	20	PASS
23	14E31A0530	M A MUJADID MOHIUDDIN	16	PASS
24	14E31A0533	MEDI NITHIN	20	PASS
25	15E31A0501	ABHISHEK KUMAR GAUTAM	20	PASS
26	15E31A0502	AFRIN	20	PASS
27	15E31A0503	ALLA VANAIA CHOWDARI	18	PASS
28	15E31A0504	AMANCHERLA GAYATHRI SUSHMA	19	PASS
29	15E31A0505	ANNARAPU KSHETHRA	20	PASS
30	15E31A0506	ARVA SHASHANK	18	PASS
31	15E31A0507	BADAM SHARATH KUMAR	17	PASS
32	15E31A0508	BAGGARI SIVA NARAYANA REDDY	20	PASS
33	15E31A0509	BEJAVADA KRISHNA SAI	19	PASS
34	15E31A0510	BELUGUPPA H S LAHARI	20	PASS
35	15E31A0512	BUNNE VAMSHI KRISHNA	18	PASS
36	15E31A0514	CHITTIMALLA SAIRAM	20	PASS
37	15E31A0515	D ESHWAR PRASAD	20	PASS
38	15E31A0516	DHYADE SHAILAJA	16	PASS
39	15E31A0517	DIDYALA KIRAN KUMAR	20	PASS
40	15E31A0518	NAKKA CHAITANYA	20	PASS

K. Sankar
PRINCIPAL
MAHAVEER
UNIVERSITY OF SCIENCE & TECHNOLOGY
BANDLAGUDA POST, KESHAVGIRI, HYDRABAD-500005.

Vysapuri, Bandlaguda Post:Keshavgiri,

MAHAVEER

INSTITUTE OF SCIENCE & TECHNOLOGY

Approved by AICTE, Affiliated to JNTUH,Hyd.



Hyderabad-500 005, TELANGANA INDIA

Tel: 040-64596979,8978380692,Fax: 040-24455003

E-mail: e3hod.cse@gmail.com,

Website: www.mist.ac.in,

DEPARTMENT OF COMPUTER SCIENCE AND ENGINEERING

41	15E31A0519	G MAHESHWARI	17	PASS
42	15E31A0520	GOULIKAR SUSHMA	20	PASS
43	15E31A0521	GUDURU SANKEERTH	20	PASS
44	15E31A0523	GURRAM RAJESH	16	PASS
45	15E31A0527	KARIGIRI RAMYA	20	PASS
46	15E31A0528	KOMANDLA ANILA REDDY	20	PASS
47	15E31A0530	L NAVYATHA	18	PASS
48	15E31A0531	M VARUN KUMAR REDDY	20	PASS
49	15E31A0537	NAGUBANDI SAIRAM PRUDHVI	19	PASS
50	15E31A0542	NIMMALA VINAYKUMAR	20	PASS
51	15E31A0543	NITISH REDDY K	18	PASS
52	15E31A0544	P VAMSHI KRISHNA	20	PASS
53	15E31A0545	PAYAPULA MAHENDAR	20	PASS
54	15E31A0546	PINJALA DHANRAJ SAGAR	16	PASS

No. of students Registered:54

No. of students Passed:54

No. of students failed:NIL

K. Srinivas
PRINCIPAL
MAHAVEER
INSTITUTE OF SCIENCE & TECHNOLOGY
Bandlaguda, Hyderabad-500 005.

Vysapuri, Bandlaguda Post:Keshavgiri,

Hyderabad-500 005, TELANGANA INDIA
Tel: 040-64596979,8978380692,Fax: 040-24455003
E-mail: a3hod.cse@gmail.com
Website: www.mist.ac.in,

MAHAVEER

INSTITUTE OF SCIENCE & TECHNOLOGY

Approved by AICTE, Affiliated to JNTUH,Hyd.



DEPARTMENT OF COMPUTER SCIENCE AND ENGINEERING

SUMMARY REPORT OF PC Hardware and Networking

- Computer Hardware is the combination of physical components or parts that makes the computer system. Physical components include **monitor, keyboard, mouse, hard disk drive, graphic card, RAM, motherboard**, etc.
- Networking is the field of computer science that allows computers to exchange data or information.

COORDINATOR

Copy to:

1. Department Notice Board
2. Principal for Information
3. Committee Members (Academic)

U. K. Reddy
PRINCIPAL
MAHAVEER
INSTITUTE OF SCIENCE & TECHNOLOGY
BANDLAGUDA, HYD-500 005.

Vysapuri, Bandlaguda Post:Keshavgin,

MAHAVEER

INSTITUTE OF SCIENCE & TECHNOLOGY

Approved by AICTE. Affiliated to JNTUH,Hyd.



Hyderabad-500 005, TELANGANA INDIA
Tel: 040-64596979,6978080692 Fax: 040-24455003
E-mail: s3hod.it@gmail.com,
Website: www.mist.ac.in,

DEPARTMENT OF INFORMATION TECHNOLOGY

Date:25-01-2017

To,

The principal,
MIST,
Hyderabad.

Sub: Proposal for Add-on Course-Reg.

Dear Sir,

We are going to conduct two weeks workshop on **Technical Training MS-Office**. We require your approval to go head for further proceeding and hope to get an opportunity to serve you the best.

With thanks and Regards

Kshy
MAHAVEER
INSTITUTE OF SCIENCE & TECHNOLOGY
Bandlaguda, Hyd-500 005.

Vysapur, Bandlaguda Post:Keshavgiri,

Hyderabad-500 005, TELANGANA INDIA
Tel: 040-64596979,8978380692.Fax: 040-24455003
E-mail: e3hod.it@gmail.com,
Website: www.mist.ac.in,

MAHAVEER

INSTITUTE OF SCIENCE & TECHNOLOGY

Approved by AICTE. Affiliated to JNTUH,Hyd.



DEPARTMENT OF INFORMATION TECHNOLOGY

Date: 01-02-2017

CIRCULAR

Technical Trainings for III & IV B. Tech students are starting from 06-02-2017 onwards. All HODs and placements coordinators have to manage the trainings and ensure 95% attendance all through the sessions.

All mentors need to send the compiled feedback report to HOD at e3hod@gmail.com daily. Mentors are advised to take care of PNR (Students not participating in training).

Agenda: Technical Training MS-Office

Design and Development of Curriculum for Add on Course:

Name of the Faculty: 1.CH B NAGALAKSHMI
2.A NANDA GOPAL REDDY
3.KBVK NAGA SREE

HOD

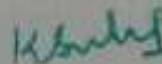

PRINCIPAL
MAHAVEER
INSTITUTE OF SCIENCE & TECHNOLOGY
Bandlaguda, Hyd-500 005

Vysapur, Sandlaguda Post, Keshavnagar,

MAHAVEER



Hyderabad-500 005, TELANGANA INDIA
Tel: 040-64505979, 8978388082. Fax: 040-24455803
E-mail: admission@mist.ac.in
Website: www.mist.ac.in

Approved by AICTE, Affiliated to JNTU-Hyd

DEPARTMENT OF INFORMATION TECHNOLOGY

SYLLABUS FOR Technical Training MS-Office

SNO	TOPIC COVERED	DURATION
1	Ms. word : Creating, editing, saving and printing text documents -	3
2	inserting tables, smart art, page breaks	3
3	Using lists and styles	3
4	Working with images	3
5	Using Spelling and Grammar check	3
6	Mail Merge	3
7	Ms. Excel: Spreadsheet basics	3
8	Creating, editing, saving and printing spreadsheets	3
9	Working with functions & formulas	3
10	Graphically representing data : Charts & Graphs	3
11	Speeding data entry : Using Data Forms	3
12	Analyzing data : Data Menu, Subtotal, Filtering Data	3
13	Ms. Power Point : Opening, viewing, creating, and printing slides	3
14	Applying auto layouts	3
15	Adding custom animation	3
16	Using slide transitions	3
17	Creating Professional Slide for Presentation.	3

M. K. Reddy
MIST

Subodh
MAHAVEER
INSTITUTE OF SCIENCE & TECHNOLOGY
Sandlaguda, Hyderabad-500 005

Vijayapuri, Hanamkonda Post, Keshavnagar,

Hyderabad-500 005, TELANGANA INDIA
Tel: 040-64536979, 8978380692 Fax: 040-24455003
E-mail: e3hodl1@gmail.com
Website: www.mst.ac.in

MAHAVEER

Approved by AICTE, Affiliated to JNTUH Hyd



DEPARTMENT OF INFORMATION TECHNOLOGY

LIST OF REGISTERED STUDENTS FOR Technical Training MS-Office

SNO	ROLL TICKET NO.	NAME OF THE STUDENT
1	13E31A1201	AKKINEPALLY SPANDANA
2	13E31A1202	BADDAM RAJ KUMAR
3	13E31A1203	BURUGU DEEPA
4	13E31A1204	CHEITHI REDDY ABAVIND REDDY
5	13E31A1207	T KARIZHAKAR
6	14E31A1202	AREKATELA DIVYA
7	14E31A1204	BE-SAI KIRAN REDDY
8	14E31A1205	BANDHYALA AKSHAY REDDY
9	14E31A1206	DEVARAMENI SRAVANI
10	14E31A1208	GANGIDI ANUSHA
11	14E31A1209	GANTE SANTHOSH
12	14E31A1210	GUJJA SAI AKHIL
13	14E31A1211	KAVETI LAJANI
14	14E31A1212	KORASIKA SAI KIRAN
15	14E31A1214	KURNAMONI DILIP
16	14E31A1215	MAHENDER SINGH
17	14E31A1216	MANDIRALI MOURICA
18	14E31A1218	MAJIMELA VINAY REDDY
19	14E31A1220	NARAGODI SHIVA VENKATA SAI
20	14E31A1221	PRANATHI PADAKANTI
21	14E31A1222	RAMA BAKESH
22	14E31A1223	RAMIDI KAVYA REDDY
23	14E31A1224	SREERAMINENI SRUJANA
24	14E31A1225	THIPPARAJU SRIVANI
25	14E31A1227	VEERAMREDDY MANASA

K. Sankar
MAHAVEER
INSTITUTE OF TECHNOLOGY
Hanamkonda Post, Keshavnagar, Hyderabad-500 005



DEPARTMENT OF INFORMATION TECHNOLOGY

Technical Training MS-Office QUESTION PAPER

Duration: 120 Minutes

20 X 1 = 20 Marks

Answer the following all questions. Each question carries 1 mark.

1. How to add first-page & end-note in word?
2. What is the shortcut keys for creating hyperlink?
3. How you can insert an online picture in your word document in word 2017?
4. How you can create a custom watermark?
5. What is the short cut key to insert a page break?
6. What is Microsoft Excel?
7. How can you add cells, rows or columns in Excel?
8. How would you format a cell? What are the options?
9. What are charts in MS Excel?
10. What is Freeze Panes in MS-Excel?
11. Is it possible to make Pivot table using multiple sources of data?
12. What are the advantages of using formulas in Excel sheet?
13. What is a Macro in Excel? How to create an Excel Macro?
14. How can you show your presentation online in PowerPoint?
15. How you can insert a slide show in PowerPoint?
16. Can we make PowerPoint slides into PDF files in PowerPoint?
17. How you can convert text to shapes in PowerPoint?
18. How to customize your slide PowerPoint?
19. How you can protect your presentation in PowerPoint?
20. How you can customize slide layout?

K. Srinivas
Principal
MAHAVEER
INSTITUTE OF SCIENCE & TECHNOLOGY
Banjara Hills, Hyd-500 005.

A. Srinivas
Asst. Prof.

Vysavuri, Bandlaguda Post, Kashavuri,

MAHAVEER



Hyderabad-500 005, TELANGANA INDIA
Tel: 040-64506979, 8978380692, Fax: 040-24455003
E-mail: edheda@gmail.com,
Website: www.mist.ac.in

Approved by AICTE, Affiliated to JNTUH, Hyd.

DEPARTMENT OF INFORMATION TECHNOLOGY

RESULT SHEET FOR Technical Training MS-Office REGISTERED STUDENTS

SSO	ROLL TICKET NO	NAME OF THE STUDENT	MARKS/100	RESULT
1	13E31A1201	AKKINEPALLY SPANDANA	20	PASS
2	13E31A1202	BADDAM RAJ KUMAR	19	PASS
3	13E31A1203	BURUGU DEEPA	20	PASS
4	13E31A1204	CHETHI REDDY ARAVIND REDDY	18	PASS
5	13E31A1207	T KARUNAKAR	20	PASS
6	14E31A1202	AREKATLA DIVYA	20	PASS
7	14E31A1204	B SAI KIRAN REDDY	19	PASS
8	14E31A1205	BANDHYALA AISHAY REDDY	20	PASS
9	14E31A1206	DEVARANENI SRAVANI	19	PASS
10	14E31A1208	GANGIDI ANUSHA	20	PASS
11	14E31A1209	GANTE SANTHOSH	20	PASS
12	14E31A1210	GUNJA SAI AKHIL	18	PASS
13	14E31A1211	KAVETI LALANI	20	PASS
14	14E31A1212	KORASIKA SAI KIRAN	20	PASS
15	14E31A1214	KURNAMONI DILIP	17	PASS
16	14E31A1215	MAHENDER SINGH	20	PASS
17	14E31A1216	MAMIDIPALLY MOUNICA	20	PASS
18	14E31A1218	NALIMELA VINAY REDDY	20	PASS
19	14E31A1220	NARAGONI SHIVA VENKATA SAI	20	PASS
20	14E31A1221	PRANATHI PADAKANTI	19	PASS
21	14E31A1222	RAMA RAKESH	18	PASS
22	14E31A1223	RAMIDI KAVYA REDDY	20	PASS
23	14E31A1224	SREERAMINENI SRUJANA	19	PASS
24	14E31A1225	THIPPARAFU SRIVANI	20	PASS
25	14E31A1227	VEERAMREDDY MANASA	18	PASS

No. of students Registered: 25

No. of students Passed: 25

No. of students failed: NIL

Kshudh
PRINCIPAL
MAHAVEER
INSTITUTE OF MANAGEMENT & TECHNOLOGY
Bandlaguda, Hyderabad-500 005

Vycapuri, Bandlaguda Post, Keshavnagar,

Hyderabad-500 095, TELANGANA INDIA
Tel: 040-64506979, 8978380092. Fax: 040-24455003
E-mail: aihod.it@gmail.com,
Website: www.mist.ac.in

MAHAVEER

Department of Information & Communication
Approved by AICTE, Affiliated to JNTUH, Hyd



DEPARTMENT OF INFORMATION TECHNOLOGY

SUMMARY REPORT OF Technical Training MS-Office

The purpose of the **MS Word** is to allow the users to type and save documents.

Microsoft **word** is used to save documents.

The documents can be copied to flash drive which serves as an external memory for your computer.

This allows you to use the saved documents conveniently taking with you anywhere.

MS Excel is a spreadsheet programme developed by Microsoft in 1985, with the sole purpose of helping businesses compile all their financial data, yearly credit, and yearly debit sheets.

Fast forward to the future after 31 years, it is now the most commonly used program for creating graphs and pivot tables.

Making your presentation more interesting through the use of multimedia can help to improve the audience's focus.

PowerPoint allows you to use images, audio and video to have a greater visual impact.

These visual and audio cues may also help a presenter be more improvisational and interact with the audience.

PRINCIPAL

Copy to

1. Department Notice Board
2. Principal for Information
3. Committee Members (Academic)

Khanji
PRINCIPAL
MAHAVEER
Department of Information & Communication
Vycapuri, Hyd-500 095

MAHAVIYER INSTITUTE OF SCIENCE & TECHNOLOGY
 DEPARTMENT OF INFORMATION TECHNOLOGY
 Technical Training MS-Office ATTENDANCE SHEET

SNO	NO	NAME OF THE STUDENT	Date														
			6	7	8	9	10	11	12	13	14	15	16	17	18		
1	13E31A1201	AKKINEPALLY SPANDANA	P	P	P	P	P	P	P	P	P	P	P	P	P	P	P
2	13E31A1202	BADDAM RAJ KUMAR	P	P	P	P	P	P	P	P	P	P	P	P	P	P	P
3	13E31A1203	BURUGU DEEPA	P	P	P	P	P	P	P	P	P	P	P	P	P	P	P
4	13E31A1204	CHEETHIREDDY ARAVIND REDDY	P	P	P	P	P	P	P	P	P	P	P	P	P	P	P
5	13E31A1205	T KARUNAKAR	P	P	P	P	P	P	P	P	P	P	P	P	P	P	P
6	14E31A1202	AREKATLA DIVYA	P	P	P	P	P	P	P	P	P	P	P	P	P	P	P
7	14E31A1204	B SAI KIRAN REDDY	P	P	P	P	P	P	P	P	P	P	P	P	P	P	P
8	14E31A1205	BANDHYALA AKSHAY REDDY	P	P	P	P	P	P	P	P	P	P	P	P	P	P	P
9	14E31A1206	DEVARAMESH SRIVANI	P	P	P	P	P	P	P	P	P	P	P	P	P	P	P
10	14E31A1208	GANGIDU ANUSHA	P	P	P	P	P	P	P	P	P	P	P	P	P	P	P
11	14E31A1209	GANTE SANTHOSH	P	P	P	P	P	P	P	P	P	P	P	P	P	P	P
12	14E31A1210	GUDJA SATAKHIL	P	P	P	P	P	P	P	P	P	P	P	P	P	P	P
13	14E31A1211	KAVETLAL ANJ	P	P	P	P	P	P	P	P	P	P	P	P	P	P	P
14	14E31A1212	KOTASIKA SAI KIRAN	P	P	P	P	P	P	P	P	P	P	P	P	P	P	P
15	14E31A1214	KURNAMONI DILIP	P	P	P	P	P	P	P	P	P	P	P	P	P	P	P
16	14E31A1215	MISHENDER SINGH	P	P	P	P	P	P	P	P	P	P	P	P	P	P	P
17	14E31A1216	MAAMIDIPALLY MOLUNIKA	P	P	P	P	P	P	P	P	P	P	P	P	P	P	P
18	14E31A1218	NALIMELA VINAY REDDY	P	P	P	P	P	P	P	P	P	P	P	P	P	P	P
19	14E31A1220	NARAGONI SHIVA VENKATA SAI	P	P	P	P	P	P	P	P	P	P	P	P	P	P	P
20	14E31A1221	PRANATHI PADAKANTI	P	P	P	P	P	P	P	P	P	P	P	P	P	P	P
21	14E31A1222	RAMA BAKESH	P	P	P	P	P	P	P	P	P	P	P	P	P	P	P
22	14E31A1223	RAMIDI KAVYA REDDY	P	P	P	P	P	P	P	P	P	P	P	P	P	P	P
23	14E31A1224	SREERAMINI SRUJANA	P	P	P	P	P	P	P	P	P	P	P	P	P	P	P
24	14E31A1225	THIPPARAJU SRIVANI	P	P	P	P	P	P	P	P	P	P	P	P	P	P	P
25	14E31A1227	VEERAMREDDY MIANASA	P	P	P	P	P	P	P	P	P	P	P	P	P	P	P

Handwritten signature

Signature of the Faculty
 MAHAVIYER
 Technical Training MS-Office
 Hyderabad, Hyd-500 005.

Handwritten signature

Vysaapuri, Bandlaguda Post, Keshavnagar,

Hyderabad-500 005, TELANGANA INDIA
Tel: 040-64596579, 8978380692 Fax: 040-24455003
E-mail: ejhod.it@gmail.com
Website: www.mist.ac.in

MAHAVEER

INSTITUTE OF SCIENCE & TECHNOLOGY

Approved by AICTE. Affiliated to JNTU-Hyd.



DEPARTMENT OF INFORMATION TECHNOLOGY

Date: 25-07-2016

To,

The principal,
MIST,
Hyderabad.

Sub: Proposal for Add-on Course-Reg.

Dear Sir,

We are going to conduct two weeks workshop on Cloud computing with HADOOP FRAMEWORK. We require your approval to go head for further proceeding and hope to get an opportunity to serve you the best.

With thanks and Regards

HOD

PRINCIPAL
MAHAVEER
INSTITUTE OF SCIENCE & TECHNOLOGY
Bandlaguda, Hyderabad 500 005.

Vysapuri, Bandlaguda Post: Keshavpuri,

Hyderabad-500 005, TELANGANA INDIA
Tel: 040-64596979, 8978380692 Fax: 040-24455003
E-mail: e3hod.it@gmail.com,
Website: www.mist.ac.in,

MAHAVEER

INSTITUTE OF SCIENCE & TECHNOLOGY

Approved by AICTE. Affiliated to JNTU-Hydr.



DEPARTMENT OF INFORMATION TECHNOLOGY

Date: 01-08-2016

CIRCULAR

Technical Trainings for II & IV B.Tech students are starting from **15-08-2016** onwards. All HODs and placements coordinators have to manage the trainings and ensure 95% attendance all through the sessions.

All mentors need to send the compiled feedback report to HOD at e3hod@gmail.com daily. Mentors are advised to take care of PNR (Students not participating in training).

Agenda: **Cloud computing with HADOOP FRAMEWORK**

Design and Development of Curriculum for Add on Course:

Name of the Faculty: 1.CH B NAGALAKSHMI
2.S.SRINIVAS
3.V NARESH KUMAR REDDY

HOD

PRINCIPAL
MAHAVEER
INSTITUTE OF SCIENCE & TECHNOLOGY
Bandlaguda Post, Hyderabad-500 005

Vyasaiah, Bandlaguda Post, Keshavnagar,

Hyderabad-500 005, TELANGANA INDIA

Tel: 040-64596979, 8970380602 Fax: 040-24455003

E-mail: ai2hod.its@gmail.com

Website: www.mist.ac.in

MAHAVEER

INSTITUTE OF SCIENCE & TECHNOLOGY

Approved by AICTE, Affiliated to JNTUH Hyd.



DEPARTMENT OF INFORMATION TECHNOLOGY

SYLLABUS FOR Cloud computing with HADOOP FRAMEWORK

S.NO	TOPIC COVERED	DURATION
1	Introduction to Cloud Computing	3
2	Adopting the Cloud	3
3	Exploiting Software as a Service (SaaS)	3
4	Delivering Platform as a Service (PaaS)	3
5	Deploying Infrastructure as a Service (IaaS)	3
6	Building a Business Case	3
7	Migrating to the Cloud	3
8	Introduction to Hadoop	3
9	Hadoop Architecture, Distributed Storage & YARN	7
10	Data Ingestion into Big Data Systems	3
11	Distributed Processing	3
12	Apache Hive	3
13	NoSQL, Data lakes-HBase	3

Handwritten signature
17-11

Handwritten signature
PROVINCIAL
MAHAVEER
INSTITUTE OF SCIENCE & TECHNOLOGY
Bandlaguda, Hyderabad-500 005



DEPARTMENT OF INFORMATION TECHNOLOGY

LIST OF REGISTERED STUDENTS FOR Cloud computing with HADOOP FRAMEWORK

SNO	HALL TICKET NO	NAME OF THE STUDENT
1	13E31A1201	AKKINEPALLY SPANDANA
2	13E31A1202	BADDAM RAJ KUMAR
3	13E31A1203	BURUGU DEEPA
4	13E31A1204	CHETHI REDDY ARAVIND REDDY
5	13E31A1207	T KARUNAKAR
6	15E31A1202	AMAN SINGH BADVAL
7	15E31A1203	ARUTLA RAJ GOPAL
8	15E31A1204	BALLA UPENDRA
9	15E31A1205	BALMOORI SARITHI
10	15E31A1206	CHATLA NIKHIL KUMAR
11	15E31A1207	D KRISHNA SRI
12	15E31A1208	D LAXMI SAROJA
13	15E31A1209	DORAGARI NIKHITHA
14	15E31A1210	DUMALA VENU
15	15E31A1211	GANDHASIRI BHARATH KUMAR
16	15E31A1212	GUNNALA SIRISHA
17	15E31A1213	K RASHMITHA
18	15E31A1214	KALIGOTA VIGNESH REDDY
19	15E31A1215	KAPARTHI SRIVARDHAN

Kanthy
PRINCIPAL
MAHAVEER
INSTITUTE OF SCIENCE & TECHNOLOGY
Bandlaguda, Hyderabad

Vysavuri, Bandlaguda Post: Keshavgiri,

Hyderabad-500 005, TELANGANA INDIA
Tel: 040-64596979,8978380692, Fax: 040-24455003
E-mail: e3hod.ii@gmail.com,
Website: www.mist.ac.in,

MAHAVEER

INSTITUTE OF SCIENCE & TECHNOLOGY

Approved by AICTE, Affiliated to JNTUH, Hyd.



DEPARTMENT OF INFORMATION TECHNOLOGY

20	15E31A1216	KARKONI NILESH
21	15E31A1217	KATAM PRIYANKA
22	15E31A1218	KATHROJU ASHOK
23	15E31A1219	KOLANU GREESHMA REDDY
24	15E31A1220	KONIDENA SAI VARSHITHA
25	15E31A1221	KOTLA VISVASRI
26	15E31A1222	KURUKUNTLA HARISH SAGAR
27	15E31A1223	KUSUMA SAI VAMSHI ADITYA
28	15E31A1224	M BHAGYA LAXMI
29	15E31A1225	MITTAKANTI ANUSHA
30	15E31A1228	PINGALI SINDHU
31	15E31A1229	POSHETTY MANISHA
32	15E31A1231	SRIPEDAMBUDUR SRINIVAS SWAMY
33	15E31A1232	TUNIKI SHIVAKUMAR
34	15E31A1233	VILASAGARAM DEVENDAR
35	15E31A1235	YETHONDA NARAHARIKRISHNA
36	14E31A1213	K.AKSHAY REDDY

K. Sankar
PRINCIPAL
MAHAVEER
INSTITUTE OF SCIENCE & TECHNOLOGY
Bandlaguda, Hyd-500 005.

AK

Vysapuri, Bandlaguda Post:Keshavgirl,

Hyderabad-500 005, TELANGANA INDIA
Tel: 040-64596979,8978380692 Fax: 040-24455003
E-mail: cs3hod.it@gmail.com
Website: www.mist.ac.in,

MAHAVEER

INSTITUTE OF SCIENCE & TECHNOLOGY

Approved by AICTE, Affiliated to JNTUH,Hyd.



DEPARTMENT OF INFORMATION TECHNOLOGY

Cloud computing with HADOOP FRAMEWORK QUESTION PAPER

Duration: 120 Minutes

10 X 2 = 20 Marks

Answer the following all questions. Each question carries 2 marks.

1. What is cloud computing?
2. What are the types of cloud?
3. What are the benefits of cloud computing?
4. Is the cloud secure?
5. How do I develop a cloud strategy?
6. What is Hadoop and its components.
7. What are HDFS and YARN?
8. Compare HDFS with Network Attached Storage (NAS).
9. List the difference between Hadoop 1 and Hadoop 2.
10. What happens when two clients try to access the same file in the HDFS?

Konky

PRINCIPAL
MAHAVEER
INSTITUTE OF SCIENCE & TECHNOLOGY
Bandlaguda, Hyd-500 005.

Ashey

HOOD-IT
Head of Department
Department of Information Technology
MIST, Hyderabad-500005

Vysapuri, Bandlaguda Post, Keshavgi,ri,

Hyderabad-500 005, TELANGANA INDIA
Tel: 040-64596979,8978380692 Fax: 040-24455003
E-mail: e3hod.it@gmail.com,
Website: www.mist.ac.in,

MAHAVEER

INSTITUTE OF SCIENCE & TECHNOLOGY

Approved by AICTE, Affiliated to JNTUH,Hyd.



DEPARTMENT OF INFORMATION TECHNOLOGY

RESULT SHEET FOR Cloud computing with HADOOP FRAMEWORK REGISTERED STUDENTS

SNO	HALL TICKET NO	NAME OF THE STUDENT	MARKS (20)	RESULT
1	13E31A1201	AKKINEPALLY SPANDANA	20	PASS
2	13E31A1202	BADDAM RAJ KUMAR	19	PASS
3	13E31A1203	BURUGU DEEPA	20	PASS
4	13E31A1204	CETHI REDDY ARAVIND REDDY	18	PASS
5	13E31A1207	T KAPUNAKAR	20	PASS
6	15E31A1202	AMAN SINGH BADYAL	20	PASS
7	15E31A1203	ARUTLA RAJ GOPAL	19	PASS
8	15E31A1204	BALLA UPENDRA	20	PASS
9	15E31A1205	BALMOORI SAHITHI	18	PASS
10	15E31A1206	CHATLA NIKHIL KUMAR	20	PASS
11	15E31A1207	D KRISHNA SRI	20	PASS
12	15E31A1208	D LAXMI SAROJA	16	PASS
13	15E31A1209	DORAGARI NIKHITHA	20	PASS
14	15E31A1210	DUMALA VENU	20	PASS
15	15E31A1211	GANDHASIRI BHARATH KUMAR	17	PASS
16	15E31A1212	GUNNALA SIRISHA	20	PASS
17	15E31A1213	K RASHMITHA	20	PASS
18	15E31A1214	KALIGOTA VIGNESH REDDY	16	PASS
19	15E31A1215	KAPARTHI SRIVARDHAN	21	PASS
20	15E31A1216	KARKONI NILESH	20	PASS
21	15E31A1217	KATAM PRIYANKA	14	PASS
22	15E31A1218	KATHROJU ASHOK	20	PASS
23	15E31A1219	KOLANU GREESHMA REDDY	19	PASS
24	15E31A1220	KONIDENA SAI VARSHITHA	20	PASS
25	15E31A1221	KOTLA VISWASRI	18	PASS
26	15E31A1222	KURUKUNTLA HARISH SAGAR	20	PASS
27	15E31A1223	KUSUMA SAI VAMSHI ADITYA	20	PASS
28	15E31A1224	M BHAGYA LAXMI	16	PASS
29	15E31A1225	MITTAKANTI ANUSHA	20	PASS
30	15E31A1228	PINGALI SINDHU	20	PASS

K. Sankar
M
Institute of Science & Technology
Bandlaguda, Hyderabad-500

Vysapuri, Bandlaguda Post:Keshavgiri,

Hyderabad-500 005, TELANGANA INDIA
Tel: 040-64596979,8978380692.Fax: 040-24455003
E-mail: e3hod.its@gmail.com,
Website: www.mist.ac.in,

MAHAVEER

INSTITUTE OF SCIENCE & TECHNOLOGY

Approved by AICTE, Affiliated to JNTU4,Hyd.



DEPARTMENT OF INFORMATION TECHNOLOGY

31	15E31A1229	POSHETTY MANISHA	20	PASS
32	15E31A1231	SRIPEDAMBUDUR SRINIVAS SWAMY	18	PASS
33	15E31A1232	TUNIKI SHIVAKUMAR	19	PASS
34	15E31A1233	VILASAGARAM DEVENDAR	18	PASS
35	15E31A1235	YETHONDA NARAHARIKRISHNA	17	PASS
36	14E31A1213	KAKSHAY REDDY	19	PASS

No. of students Registered:36

No. of students Passed:36

No. of students failed:NIL

K. Sankar
PRINCIPAL
MAHAVEER
INSTITUTE OF SCIENCE & TECHNOLOGY
Bandlaguda, Hyd-500 005.

Vysapuri, Bandlaguda Post:Keshavpuri,

Hyderabad-500 005, TELANGANA INDIA
Tel: 040-64596979,8978380692,Fax: 040-24455003
E-mail: s3hod.it@gmail.com,
Website: www.mist.ac.in,

MAHAVEER

INSTITUTE OF SCIENCE & TECHNOLOGY

Approved by AICTE, Affiliated to JNTUH,Hyd.



DEPARTMENT OF INFORMATION TECHNOLOGY

SUMMARY REPORT OF Cloud computing with HADOOP FRAMEWORK

Cloud computing is perhaps the most flamboyant technological innovation of the 21st century. This is because it has seen the fastest adoption into the mainstream than any other technology in the domain.

This adoption has been fueled mainly by the ever-increasing number of smart phones and mobile devices that can access the internet.

Cloud computing is not just for organizations and businesses; it's also useful for the average person as well.

It enables us to run software programs without installing them on our computers; it enables us to store and access our multimedia content via the internet, it enables us to develop and test programs without necessarily having servers and so on.

Hadoop is an open source platform that provides excellent data management provision. It is a framework that supports the processing of large data sets in a distributed computing environment.

It is designed to expand from single servers to thousands of machines, each providing computation and storage.

Its distributed file system facilitates rapid data transfer rates among nodes and allows the system to continue operating uninterrupted in case of a node failure, which minimizes the risk of catastrophic system failure, even if a significant number of nodes become out of action.

COORDINATOR

Copy to:

1. Department Notice Board
2. Principal for Information
3. Committee Members (Academic)

PRINCIPAL
MAHAVEER
INSTITUTE OF SCIENCE & TECHNOLOGY
Bandlaguda, Hyd-500 005.

MHAHAVEER INSTITUTE OF SCIENCE & TECHNOLOGY
DEPARTMENT OF INFORMATION TECHNOLOGY

Cloud Computing with HADOOP FRAMEWORK ATTENDANCE SHEET

SNO	HALL TICKET	NAME OF THE STUDENT	Date	15	16	17	18	19	20	21	22	23	24	25	26	27	28	29	30	31
1	15E31A1201	AKKINEPALLY SPANDANA		P	A	P	P	P	P	P	P	P	P	P	P	P	P	P	P	P
2	15E31A1202	BADDAM RAJ KUMAR		P	P	A	P	P	P	P	P	P	P	P	P	P	P	P	P	P
3	15E31A1203	BURUGU DEEPA		P	P	A	P	P	P	P	P	P	P	P	P	P	P	P	P	P
4	15E31A1204	CHETHI REDDY ARAVIND REDDY		P	P	A	P	P	P	P	P	P	P	P	P	P	P	P	P	P
5	15E31A1207	T KARUNAKAR		P	P	A	P	P	P	P	P	P	P	P	P	P	P	P	P	P
6	15E31A1202	AMAN SINGH BADYAL		P	P	A	P	P	P	P	P	P	P	P	P	P	P	P	P	P
7	15E31A1203	ARUTLA RAJ GOPAL		P	P	A	P	P	P	P	P	P	P	P	P	P	P	P	P	P
8	15E31A1204	BALLA UPENDRA		P	P	A	P	P	P	P	P	P	P	P	P	P	P	P	P	P
9	15E31A1205	BALMOORI SAHITHI		P	P	A	P	P	P	P	P	P	P	P	P	P	P	P	P	P
10	15E31A1206	CHATLA NIKHIL KUMAR		P	P	A	P	P	P	P	P	P	P	P	P	P	P	P	P	P
11	15E31A1207	D KRISHNA SRI		P	P	A	P	P	P	P	P	P	P	P	P	P	P	P	P	P
12	15E31A1208	D LAXMI SAROJA		P	P	A	P	P	P	P	P	P	P	P	P	P	P	P	P	P
13	15E31A1209	DORAGARI NIKHITHA		P	P	A	P	P	P	P	P	P	P	P	P	P	P	P	P	P
14	15E31A1210	DUMALA VENU		P	P	A	P	P	P	P	P	P	P	P	P	P	P	P	P	P
15	15E31A1211	GANDEHASIRI BHARATHI KUMAR		P	P	A	P	P	P	P	P	P	P	P	P	P	P	P	P	P
16	15E31A1212	GUNNALA SIRISHA		P	P	A	P	P	P	P	P	P	P	P	P	P	P	P	P	P
17	15E31A1213	K RASHMITHA		P	P	A	P	P	P	P	P	P	P	P	P	P	P	P	P	P
18	15E31A1214	KALIGOTA VIGNESH REDDY		P	P	A	P	P	P	P	P	P	P	P	P	P	P	P	P	P
19	15E31A1215	KAPARTHI SRIVARDHAN		P	P	A	P	P	P	P	P	P	P	P	P	P	P	P	P	P
20	15E31A1216	KARKONI NILESH		P	P	A	P	P	P	P	P	P	P	P	P	P	P	P	P	P
21	15E31A1217	KATAMPRIYANKA		P	P	A	P	P	P	P	P	P	P	P	P	P	P	P	P	P
22	15E31A1218	KATHROJU ASHOK		P	P	A	P	P	P	P	P	P	P	P	P	P	P	P	P	P
23	15E31A1219	KOLANU GRESHMA REDDY		P	P	A	P	P	P	P	P	P	P	P	P	P	P	P	P	P
24	15E31A1220	KONIDENA SAI VARSHITHA		P	P	A	P	P	P	P	P	P	P	P	P	P	P	P	P	P
25	15E31A1221	KOTLA VISWASRI		P	P	A	P	P	P	P	P	P	P	P	P	P	P	P	P	P
26	15E31A1222	RURUKUNTLA HARISH SAGAR		P	P	A	P	P	P	P	P	P	P	P	P	P	P	P	P	P
27	15E31A1223	RUSUMA SATYAMSHI ADITYA		P	P	A	P	P	P	P	P	P	P	P	P	P	P	P	P	P
28	15E31A1224	M BHAGYA LAXMI		P	P	A	P	P	P	P	P	P	P	P	P	P	P	P	P	P

W. PRINCIPAL
MHAHAVEER
INSTITUTE OF SCIENCE & TECHNOLOGY
WIND-500 005

Vysapuri, Bandlaguda Post:Keshavgiri,
Hyderabad-500 005, Telangana INDIA
Tel: 040-64596979,20020773, Fax: 040-24455003
E-mail: principal.mahaveer@gmail.com,
Website: www.mist.ac.in,

MAHAVEER

INSTITUTE OF SCIENCE & TECHNOLOGY
Approved by AICTE, Affiliated to JNTUH,Hyd.



DEPARTMENT OF AERONAUTICAL ENGINEERING

PROPOSAL LETTER

Hyderabad,

10/08/2016.

To,
The principal,
MIST,
Hyderabad.

Sub: Proposal for two weeks workshop on Micro Category Multi rotor Drone Pilot Course-Reg,

Dear Sir,

We are working as asst professor in the department of AERONAUTICAL ENGINEERING. Sir, we are going to conduct three weeks workshop on Micro Category Multi rotor Drone Pilot Course. We require your approval to go head for further proceeding and hope to get an opportunity to serve you the best.

With thanks and Regards

From,
AERO Department
Mist,
Bandlaguda,

Handwritten signature
PRINCIPAL
MAHAVEER
INSTITUTE OF SCIENCE & TECHNOLOGY
Bandlaguda, Hyd-500 005.

Handwritten signature

Vysapuri, Bandlaguda Post:Keshavgiri,
Hyderabad-500 005, Telangana INDIA
Tel: 040-64596979,20020773, Fax: 040-24455003
E-mail: principal.mahaveer@gmail.com,
Website: www.mist.ac.in,

MAHAVEER
INSTITUTE OF SCIENCE & TECHNOLOGY
Approved by AICTE, Affiliated to JNTUH,Hyd.



DEPARTMENT OF AERONAUTICAL ENGINEERING

Date: 12.08.2016

CIRCULAR

Technical Training for II B. Tech students are starting from 12-08-2016 onwards. All HODs and Placements coordinators have to manage the trainings and ensure 95% attendance all through the sessions.

All Mentors need to send the compiled feedback report to A RangaReddy, HOD at e3hod.aero@gmail.com daily.

Agenda: 1. **Micro Category Multicopter Drone Pilot Course**

Prof RANGA REDDY

HOD

Course Designed By

Y RAGHUVeer

G RAJESH KUMAR

Kshy
PRINCIPAL
MAHAVEER
INSTITUTE OF SCIENCE & TECHNOLOGY
Bandlaguda, Hyd-500 005.



Multi rotor Drone Pilot Course

SYLLABUS

1: Introduction to Multirotor Drones, DGCA Regulations

- Regulations of DGCA
- Basic Principles of Flight
- Multirotor Introduction
- Drone Equipment Maintenance

2: Introduction to Flight Simulator Training

- Introduction to Flight Simulator
- Flight Simulator Training

3: Important Parts and Components in a Multirotor

- Drone Assembling
- Identification of each component in a Multirotor Assembling and calibrating
- Practical flying with instructor

Keshav
PRINCIPAL
MAHAVEER
INSTITUTE OF SCIENCE & TECHNOLOGY
Bandlaguda, Hyd-500 005.



Multi rotor Drone Pilot Course

STUDENT LIST 2016-17

	Hall Ticket No	Name of the Candidate	year
1	14E31A2101	ABDUL AZIZ	II
2	14E31A2102	BHUKYA VENKATESH	II
3	14E31A2103	BRAHMANLAPALLY SAI KIRAN	II
4	14E31A2104	CH PHANEENDRA	II
5	14E31A2105	CHEEKATI PREETHI RACHEL	II
6	14E31A2106	CHOPPALA VISHAL	II
7	14E31A2108	GUMMADI ANIRUDH	II
8	14E31A2109	GUVVALA RAKESH	II
9	14E31A2110	INDROJU ARCHITHA	II
10	14E31A2111	KESHABOINA RAHUL	II
11	14E31A2112	KISARI NITHIN KUMAR	II
12	14E31A2113	MALIK NOUMAN BADR	II
13	14E31A2114	MARKANTI ANJANEYULU	II
14	14E31A2116	MD ALTAMASH NIZAMI AL SABHA	II
15	14E31A2117	MOHAMMAD ADNAN	II
16	14E31A2118	MOHAMMAD FAIYAZ	II
17	14E31A2119	MOHAMMED ABDUL QADEER	II
18	14E31A2120	MOHD ABDUL MALIK YASER	II
19	14E31A2121	MOHD MAJID ALI INSHAAL	II
20	14E31A2122	MOTHA SAIKIRAN	II
21	14E31A2123	MOTHUKURI SAI KRISHNA	II
22	14E31A2124	MUDAVATH ANIL	II
23	14E31A2125	MURAHARI KISHORE	II
24	14E31A2126	MYATHARI SALOMON	II
25	14E31A2127	PEDHAGOVINDU SURYANSH SAGAR	II
26	14E31A2128	PERAM AMULYA	II
27	14E31A2129	POTLURU JAGADEESH	II

Kishu
PRINCIPAL
MAHAVEER
INSTITUTE OF SKILLS & TECHNOLOGY
Bandlaguda, Hyd-500 005

J. Dhanasekhar
HOD

Vysapuri, Bandlaguda Post:Keshavgiri,
Hyderabad-500 005, Telangana INDIA
Tel: 040-64596979,20020773, Fax: 040-24455003
E-mail: principal.mahaveer@gmail.com,
Website: www.mist.ac.in,

MAHAVEER

INSTITUTE OF SCIENCE & TECHNOLOGY

Approved by AICTE. Affiliated to JNTUH,Hyd.



Technical Training Exam on
(A.Y-2016-17)

4x5=20 Marks

Answer All the Questions Multirotor Drone Pilot Course

1. Basic Principles of Flight?
2. Multi rotor Introduction?
3. Drone Equipment Maintenance?
4. Drone Assembling?

Keshav

PRINCIPAL
MAHAVEER
INSTITUTE OF SCIENCE & TECHNOLOGY
Bandlaguda, Hydr-500 005.



Micro Category Multi rotor Drone Pilot Course

Training student marks list 2016-17

S NO	Hall Ticket No	Name of the Candidate	year	marks	pass/fail
1	14E31A2101	ABDUL AZIZ	II	18	pass
2	14E31A2102	BHUKYA VENKATESH	II	17	pass
3	14E31A2103	BRAHMANLAPALLY SAI KIRAN	II	15	pass
4	14E31A2104	CH PHANEENDRA	II	17	pass
5	14E31A2105	CHEEKATI PREETHI RACHEL	II	16	pass
6	14E31A2106	CHOPPALA VISHAL	II	12	pass
7	14E31A2108	GUMMADI ANIRUDH	II	17	pass
8	14E31A2109	GUVVALA RAKESH	II	13	pass
9	14E31A2110	INDROJU ARCHITHA	II	17	pass
10	14E31A2111	KESHABOINA RAHUL	II	17	pass
11	14E31A2112	KISARI NITHIN KUMAR	II	15	pass
12	14E31A2113	MALIK NOUMAN BADR	II	17	pass
13	14E31A2114	MARKANTI ANJANEYULU	II	12	pass
14	14E31A2116	MD ALTAMASH NIZAMI AL SABHA	II	17	pass
15	14E31A2117	MOHAMMAD ADNAN	II	16	pass
16	14E31A2118	MOHAMMAD FAIYAZ	II	17	pass
17	14E31A2119	MOHAMMED ABDUL QADEER	II	19	pass
18	14E31A2120	MOHD ABDUL MALIK YASER	II	17	pass
19	14E31A2121	MOHD MAJID ALI INSHAAL	II	16	pass
20	14E31A2122	MOTHA SAIKIRAN	II	17	pass
21	14E31A2123	MOTHUKURI SAI KRISHNA	II	18	pass
22	14E31A2124	MUDAVATH ANIL	II	17	pass
23	14E31A2125	MURAHARI KISHORE	II	15	pass
24	14E31A2126	MYATHARI SALOMON	II	17	pass
25	14E31A2127	PEDHAGOVINDU SURYANSH SAGAR	II	17	pass
26	14E31A2128	PERAM AMULYA	II	15	pass
27	14E31A2129	POTLURU JAGADEESH	II	17	pass

Kanika
MIST
Institute of Science & Technology
Bandlaguda, Hyderabad-500 005.

A. Annureddy
HOD

MAHAVEER INSTITUTE OF SCIENCE AND TECHNOLOGY
AERONAUTICAL ENGINEERING
COURSE ATTENDANCE LIST

S NO	HT NO	NAME	DATE	12	15	16	17	19	22	23	24	25	26
1	14E31A2101	ABDUL AZIZ		P	P	P	P	P	P	P	P	P	P
2	14E31A2102	BHUKYA VENKATESH		P	P	P	P	P	P	P	P	P	P
3	14E31A2103	BRAHMAN LAPALLY SAI KIRAN		P	P	P	P	P	P	P	P	P	P
4	14E31A2104	CH PHANEENDRA		P	P	P	P	P	P	P	P	P	P
5	14E31A2105	CHEEKATI PREETHI RACHEL		P	P	P	P	P	P	P	P	P	P
6	14E31A2106	CHOPPALA VISHAL		P	P	P	P	P	P	P	P	P	P
7	14E31A2108	GUMMADI ANIRUDH		P	P	P	P	P	P	P	P	P	P
8	14E31A2109	GU'VVALA RAKESH		P	P	P	P	P	P	P	P	P	P
9	14E31A2110	INDROJU ARCHITHA		P	P	P	P	P	P	P	P	P	P
10	14E31A2111	KESHABOINA RAHUL		P	P	P	P	P	P	P	P	P	P
11	14E31A2112	KISARI NITHIN KUMAR		P	P	P	P	P	P	P	P	P	P
12	14E31A2113	MALIK NOUMAN BADR		P	P	P	P	P	P	P	P	P	P
13	14E31A2114	MARKANTI ANJANEYULU		P	P	P	P	P	P	P	P	P	P
14	14E31A2116	MD ALTAMASH NEZAMI AL SABHA		P	P	P	P	P	P	P	P	P	P
15	14E31A2117	MOHAMMAD ADNAN		P	P	P	P	P	P	P	P	P	P
16	14E31A2118	MOHAMMAD FAIYAZ		P	P	P	P	P	P	P	P	P	P
17	14E31A2119	MOHAMMED ABDUL QADEER		P	P	P	P	P	P	P	P	P	P
18	14E31A2120	MOHD ABDUL MALIK YASER		P	P	P	P	P	P	P	P	P	P
19	14E31A2121	MOHD MAJID ALI INSHAAL		P	P	P	P	P	P	P	P	P	P
20	14E31A2122	MOTHA SAIKIRAN		P	P	P	P	P	P	P	P	P	P
21	14E31A2123	MOTHUKURI SAI KRISHNA		P	P	P	P	P	P	P	P	P	P
22	14E31A2124	MUDAVATH ANIL		P	P	P	P	P	P	P	P	P	P
23	14E31A2125	MURAHARI KISHORE		P	P	P	P	P	P	P	P	P	P
24	14E31A2126	MYATHARI SALOMON		P	P	P	P	P	P	P	P	P	P
25	14E31A2127	PEDHAGOVIDU SURYANSH SAGAR		P	P	P	P	P	P	P	P	P	P
26	14E31A2128	PERAM AMULYA		P	P	P	P	P	P	P	P	P	P
27	14E31A2129	POTLURU JAGADEESH		P	P	P	P	P	P	P	P	P	P

Principal

MAHAVEER
INSTITUTE OF SCIENCE & TECHNOLOGY
BANGALORE, 560025

M. Anand

H/o



Course :Multi rotor Drone Pilot Course

Report summary

A multirotor or multicopter is a rotorcraft with more than two lift-generating rotors. An advantage of multirotor aircraft is the simpler rotor mechanics required for flight control. Unlike single- and double-rotor helicopters which use complex variable pitch rotors whose pitch varies as the blade rotates for flight stability and control, multirotors often use fixed-pitch blades; control of vehicle motion is achieved by varying the relative speed of each rotor to change the thrust and torque produced by each.

There are four main physical types of professional drones: multi-rotor, fixed-wing, single-rotor helicopter, and fixed-wing hybrid VTOL. The different body styles of each type of drone contribute to the amount of weight they can carry (payload), efficiency and duration of the flight.

N. Dornaleary

HOD

Kanby
M.A. P. A. V. S. S. S. S.
INSTITUTE OF SCIENCE & TECHNOLOGY
Bandlaguda, Hyderabad-500 005

Vysapuri, Bandlaguda Post:Keshavgirl,
Hyderabad-500 005, Telangana INDIA
Tel: 040-64596979,20020773, Fax: 040-24455003
E-mail: principal.mahaveer@gmail.com,
Website: www.mist.ac.in,

MAHAVEER

INSTITUTE OF SCIENCE & TECHNOLOGY
Approved by AICTE, Affiliated to JNTUH,Hyd.



CERTIFICATE OF COURSE COMPLETION

This certificate is presented to BHUKYA VENKATESH of MIST, who has successfully completed technical training course on “Micro Category Multirotor Drone Pilot Course” held from 12-08-2016 to 26-08-2016 and found the student performance to be excellent.



ESTD : 2001

A RANGA REDDY

HOD (AERO)

Kanish
MAHAVEER
INSTITUTE OF SCIENCE & TECHNOLOGY
Bandlaguda, Hyd-500 005

Vysapuri, Bandlaguda Post:Keshavgiri,

Hyderabad-500 005, TELANGANA INDIA
Tel: 040-64596979,8978380692,Fax: 040-24455003
E-mail: e3hod.it@gmail.com,
Website: www.mist.ac.in,

MAHAVEER
INSTITUTE OF SCIENCE & TECHNOLOGY
Approved by AICTE, Affiliated to JNTUH,Hyd.



DEPARTMENT OF HUMANITIES AND SCIENCES

Date: 25-08-16

To,
The principal,
MIST ,
Hyderabad.

Sub: Proposal for Add-on-course-Reg
Dear sir,

We are going to conduct Add-On course on Atomic structure. we require your approval to go head for further proceeding and hope to get an opportunity to serve you the best.

With thanks and Regards

PRINCIPAL
MAHAVEER
INSTITUTE OF SCIENCE & TECHNOLOGY
Bandlaguda, Hyd-500 005.

HOD
Department of Humanities & Sciences
Mahaveer Institute of Science & Technology,
HYDERABAD

Vysapuri, Bandlaguda Post:Keshavgiri,

Hyderabad-500 005, TELANGANA INDIA
Tel: 040-64596979,8978380692,Fax: 040-24455003
E-mail: e3hod.it@gmail.com,
Website: www.mist.ac.in,

MAHAVEER
INSTITUTE OF SCIENCE & TECHNOLOGY
Approved by AICTE, Affiliated to JNTUH,Hyd.



DEPARTMENT OF HUMANITIES AND SCIENCES

Date: 25-08-16

CIRCULAR

CRASH COURSE FOR I B.Tech students are starting from 25-08-16 onwards. All HODs and placements coordinators have to manage the trainings and ensure 95% attendance all through the sessions.

All mentors need to send the compiled feedback report to HOD at e3hod@gmail.com daily. Mentors are advised to take care of PNR (Students not participating in training).

Agenda: **ATOMIC STRUCTURE**

Design and Development of Curriculum for Add on Course

Name of Faculty: 1.Dr.Deetphi
2.Ayya swamy

PRINCIPAL
MAHAVEER
INSTITUTE OF SCIENCE & TECHNOLOGY
Bandlaguda, Hyd-500 005.



HOD
Department of Humanities & Sciences
Mahaveer Institute of Science & Technology,
HYDERABAD

HOD

Vysapuri, Bandlaguda Post:Keshavgi,

Hyderabad-500 005, TELANGANA INDIA
Tel: 040-64596979,8978380692,Fax: 040-24455003
E-mail: e3hod.it@gmail.com,
Website: www.mist.ac.in,

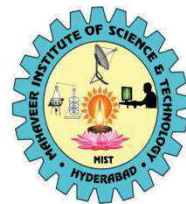
MAHAVEER
INSTITUTE OF SCIENCE & TECHNOLOGY
Approved by AICTE, Affiliated to JNTUH,Hyd.



DEPARTMENT OF HUMANITIES AND SCIENCES

SYLLABUS FOR ATOMIC STRUCTURE

SNO	TOPIC COVERED	DURATION
1	Sub-atomic Particles.	3
2	Atomic models.	3
3	Dual nature of Matter.	3
4	Photoelectric Effect.	3
5	Electromagnetic Radiations.	3
6	Quantum Mechanical Model of Atoms.	3
7	Electronic Configuration.	3
8	Discovery of Electron Proton and Neutron.	3

PRINCIPAL
MAHAVEER
INSTITUTE OF SCIENCE & TECHNOLOGY
Bandlaguda, Hyd-500 005.

HOD
Department of Humanities & Sciences
Mahaveer Institute of Science & Technology,
HYDERABAD

HOD

Vysapuri, Bandlaguda Post:Keshavgiri,

Hyderabad-500 005, TELANGANA INDIA

Tel: 040-64596979,8978380692,Fax: 040-24455003

E-mail: e3hod.it@gmail.com,

Website: www.mist.ac.in,

MAHAVEER
INSTITUTE OF SCIENCE & TECHNOLOGY

Approved by AICTE, Affiliated to JNTUH,Hyd.

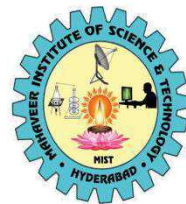

DEPARTMENT OF HUMANITIES AND SCIENCES

LIST OF REGISTERED STUDENTENS FOR ATOMIC STRUCTURE

SNO	HOLL TICKET NO	NAME OF THE STUDENT
1	16E31A0407	B NAVYA SRI
2	16E31A0413	DESHAM PREETHIKA
3	16E31A0435	PAKEER GANESH
4	16E31A0465	B PRADEEP
5	16E31A04A0	THOTA NARESH
6	16E31A0212	K VEERESH
7	16E31A0222	MUTHINENI VAMSHI
8	16E31A0225	PUNNA VAISHNAVI
9	16E31A0228	ROSHAN PATNAIK
10	16E31A1202	ADURLA PAVAN
11	16E31A1219	PAIPATI SHILPA REDDY
12	16E31A1228	VADHADIYA SRINA
13	16E31A1231	YASA ABHINAYA
14	16E31A0505	AVULA VAISHNAVI
15	16E31A0518	KONDA SOWMYA
16	16E31A0564	BOMMA NITIN
17	16E31A0578	JAKKULA NARESH
18	16E31A0585	MAROJU SHIVANI
19	16E31A0593	NATTI SRILEKHA
20	16E31A05B3	AKULA VARSHINI
21	16E31A05C7	KODALI SAI KRISHNA
22	16E31A05F0	VOJJALA MANASA
23	16E31A0306	G VENU GOPAL
24	16E31A0313	KOVA SAIKUMAR
25	16E31A0324	NALLA TEJASWI

Keshavi

PRINCIPAL
MAHAVEER
INSTITUTE OF SCIENCE & TECHNOLOGY
Bandlaguda, Hyd-500 005.

Vysapuri, Bandlaguda Post:Keshavgi,

Hyderabad-500 005, TELANGANA INDIA

Tel: 040-64596979,8978380692,Fax: 040-24455003

E-mail: e3hod.it@gmail.com,

Website: www.mist.ac.in,

MAHAVEER

INSTITUTE OF SCIENCE & TECHNOLOGY

Approved by AICTE, Affiliated to JNTUH,Hyd.

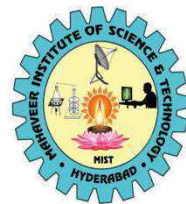

DEPARTMENT OF HUMANITIES AND SCIENCES

ATOMIC STRUCTURE QUESTION PAPER

DURATION:120 MINUTES

MAX.MARKS 50

ANSWER ANY FIVE QUESTION.

5*10=50

1. what are Atomic models.
2. Discribe Dual nature of Matter
3. Explain the concept of Photoelectric Effect
4. Explain Quantum Mechanical Model of Atoms
5. What is Electronic Configuration
6. Explain the process of Discovery of Electron Proton and Neutron

PRINCIPAL
MAHAVEER
INSTITUTE OF SCIENCE & TECHNOLOGY
Bandlaguda, Hyd-500 005.

Vysapuri, Bandlaguda Post:Keshavgi,

Hyderabad-500 005, TELANGANA INDIA

Tel: 040-64596979,8978380692,Fax: 040-24455003

E-mail: e3hod.it@gmail.com,

Website: www.mist.ac.in,

MAHAVEER
INSTITUTE OF SCIENCE & TECHNOLOGY

Approved by AICTE, Affiliated to JNTUH,Hyd.



DEPARTMENT OF HUMANITIES AND SCIENCES

RESULT SHEET FOR ATOMIC STRUCTURE REGISTERED STUDENTS

SNO	HOLL TICKET NO	NAME OF THE STUDENT	MARKS(20)	RESULT
1	16E31A0407	B NAVYA SRI	20	PASS
2	16E31A0413	DESHAM PREETHIKA	19	PASS
3	16E31A0435	PAKEER GANESH	20	PASS
4	16E31A0465	B PRADEEP	18	PASS
5	16E31A04A0	THOTA NARESH	20	PASS
6	16E31A0212	K VEERESH	19	PASS
7	16E31A0222	MUTHINENI VAMSHI	18	PASS
8	16E31A0225	PUNNA VAISHNAVI	20	PASS
9	16E31A0228	ROSHAN PATNAIK	18	PASS
10	16E31A1202	ADURLA PAVAN	18	PASS
11	16E31A1219	PAIPATI SHILPA REDDY	19	PASS
12	16E31A1228	VADHADIYA SRINA	19	PASS
13	16E31A1231	YASA ABHINAYA	20	PASS
14	16E31A0505	AVULA VAISHNAVI	20	PASS
15	16E31A0518	KONDA SOWMYA	20	PASS
16	16E31A0564	BOMMA NITIN	19	PASS
17	16E31A0578	JAKKULA NARESH	19	PASS
18	16E31A0585	MAROJU SHIVANI	18	PASS
19	16E31A0593	NATTI SRILEKHA	18	PASS
20	16E31A05B3	AKULA VARSHINI	20	PASS
21	16E31A05C7	KODALI SAI KRISHNA	18	PASS
22	16E31A05F0	VOJJALA MANASA	17	PASS
23	16E31A0306	G VENU GOPAL	16	PASS
24	16E31A0313	KOVA SAIKUMAR	20	PASS
25	16E31A0324	NALLA TEJASWI	19	PASS

No.of students registred:20

No.of students passed :20

No.of students failed :Nil

PRINCIPAL
MAHAVEER
INSTITUTE OF SCIENCE & TECHNOLOGY
Bandlaguda, Hyd-500 005.

HOD
Department of Humanities & Sciences
Mahaveer Institute of Science & Technology,
HYDERABAD

Vysapuri, Bandlaguda Post:Keshavgiri,

Hyderabad-500 005, TELANGANA INDIA

Tel: 040-64596979,8978380692,Fax: 040-24455003

E-mail: e3hod.it@gmail.com,

Website: www.mist.ac.in,

MAHAVEER
INSTITUTE OF SCIENCE & TECHNOLOGY

Approved by AICTE, Affiliated to JNTUH,Hyd.



DEPARTMENT OF HUMANITIES AND SCIENCES

SUMMARY REPORT OF CERTIFICATE COURSE ON ATOMIC STRUCTURE

Atoms consist of protons and neutrons in the nucleus, surrounded by electrons that reside in orbitals. Orbitals are classified according to the four quantum numbers that represent any one particular orbital's energy, shape, orientation, and the spin of the occupying electron. The first section of this SparkNote on Atomic Structure will focus on the electron and the mechanism of describing electrons and their orbitals. As we shall see in the second section, electrons fill up orbitals in a systematic fashion, following the rules of the Aufbau principle. The configuration of electrons in an atom play a vital role in chemistry. Virtually every chemical process relies on the interactions of electrons between atoms, most particularly on the tendency of atoms to follow the octet rule, the tendency to gain a full valence shell electrons. In the second section of this SparkNote, we will discuss the properties of electrons, distinguishing between valence electrons and inner electrons, then broadening the discussion into an examination of the properties of electron configurations.

COPY TO:

1. Department notice board.
2. Principal for information
3. committee members (academic)

PRINCIPAL
MAHAVEER
INSTITUTE OF SCIENCE & TECHNOLOGY
Bandlaguda, Hyd-500 005.

MAHAVEER INSTITUTE OF SCIENCE & TECHNOLOGY
DEPARTMENT OF HUMANITIES AND SCIENCE
ATOMIC STRUCTURE ATTENDANCE SHEET

S.NO	H.T NO	NAME OF THE STUDENT	Date																			
			1	2	3	4	5	6	7	8	9	10	11	12	13	14	15	16	17	18	19	20
1	16E31A0407	B NAVYA SRI	P	P	P	P	P	P	P	P	P	P	P	P	P	P	P	P	P	P	P	P
2	16E31A0411	DESHAM PREETHIKA	P	P	P	P	P	P	P	P	P	P	P	P	P	P	P	P	P	P	P	P
3	16E31A0452	PAKEER GANESH	P	P	P	P	P	P	P	P	P	P	P	P	P	P	P	P	P	P	P	P
4	16E31A0465	B PRADEEP	P	P	P	P	P	P	P	P	P	P	P	P	P	P	P	P	P	P	P	P
5	16E31A04A0	THOTA NARESH	P	P	P	P	P	P	P	P	P	P	P	P	P	P	P	P	P	P	P	P
6	16E31A0212	K VEERESH	P	P	P	P	P	P	P	P	P	P	P	P	P	P	P	P	P	P	P	P
7	16E31A0222	MUTHINENI VAMSHI	P	P	P	P	P	P	P	P	P	P	P	P	P	P	P	P	P	P	P	P
8	16E31A0225	PUNNA VAISHNAVI	P	P	P	P	P	P	P	P	P	P	P	P	P	P	P	P	P	P	P	P
9	16E31A0228	ROSHAN PATNAIK	P	P	P	P	P	P	P	P	P	P	P	P	P	P	P	P	P	P	P	P
10	16E31A1202	ADURLA PAVAN	P	P	P	P	P	P	P	P	P	P	P	P	P	P	P	P	P	P	P	P
11	16E31A1219	PAIPATI SHILPA REDDY	P	P	P	P	P	P	P	P	P	P	P	P	P	P	P	P	P	P	P	P
12	16E31A1228	VADHADIYA SRINA	P	P	P	P	P	P	P	P	P	P	P	P	P	P	P	P	P	P	P	P
13	16E31A1231	YASA ABHINAYA	P	P	P	P	P	P	P	P	P	P	P	P	P	P	P	P	P	P	P	P
14	16E31A0505	AVULA VAISHNAVI	P	P	P	P	P	P	P	P	P	P	P	P	P	P	P	P	P	P	P	P
15	16E31A0518	KONDA SOWMYA	P	P	P	P	P	P	P	P	P	P	P	P	P	P	P	P	P	P	P	P
16	16E31A0564	BOMMA NITIN	P	P	P	P	P	P	P	P	P	P	P	P	P	P	P	P	P	P	P	P
17	16E31A0578	JAKKULA NARESH	P	P	P	P	P	P	P	P	P	P	P	P	P	P	P	P	P	P	P	P
18	16E31A0585	MAROJU SHIVANI	P	P	P	P	P	P	P	P	P	P	P	P	P	P	P	P	P	P	P	P
19	16E31A0593	NATTI SRILEKHA	P	P	P	P	P	P	P	P	P	P	P	P	P	P	P	P	P	P	P	P
20	16E31A05B3	AKULA VARSHINI	P	P	P	P	P	P	P	P	P	P	P	P	P	P	P	P	P	P	P	P
21	16E31A05C7	KODALI SAI KRISHNA	P	P	P	P	P	P	P	P	P	P	P	P	P	P	P	P	P	P	P	P
22	16E31A05F0	VOJITALA MANASA	P	P	P	P	P	P	P	P	P	P	P	P	P	P	P	P	P	P	P	P
23	16E31A0306	O VENU GOPAL	P	P	P	P	P	P	P	P	P	P	P	P	P	P	P	P	P	P	P	P
24	16E31A0313	KOVA SAIKUMAR	P	P	P	P	P	P	P	P	P	P	P	P	P	P	P	P	P	P	P	P
25	16E31A0324	NALLA TEJASWI	P	P	P	P	P	P	P	P	P	P	P	P	P	P	P	P	P	P	P	P

M Ratibla



**MAHAVEER INSTITUTE OF
SCIENCE AND TECHNOLOGY**
APPROVED BY AICTE AFFILIATED TO JNTUH - HYD.
DEPARTMENT OF
HUMANITIES AND SCIENCES

Certificate

This is to certify that Mr/Ms B BHAVYA SRI
bearing Hall Ticket No 16E31A0407 of B.Tech First Year
has participated In Certificate course on
ATOMIC STRUCTURE

From 25-08-16 to 16-09-16

Organized by Dept. of Humanities and Sciences

M Pratibha

HOD
Department of Humanities & Sciences
Mahaveer Institute of Science & Technology
HYDRABAD

M. S. S. S.

PRINCIPAL
MAHAVEER INSTITUTE OF SCIENCE & TECHNOLOGY
HYDRABAD

Vysapuri, Bandlaguda Post:Keshavgi,
Hyderabad-500 005, Telangana INDIA
Tel: 040-64596979,20020773, Fax: 040-24455003
E-mail: principal.mahaveer@gmail.com,
Website: www.mist.ac.in,

MAHAVEER
INSTITUTE OF SCIENCE & TECHNOLOGY
Approved by AICTE, Affiliated to JNTUH,Hyd.



DEPARTMENT OF CIVIL ENGINEERING

PROPOSAL LETTER

Hyderabad,

16/08/2017.

To,
The principal,
MIST,
Hyderabad.

Sub: Proposal for three weeks workshop on ETABS-Reg.

Dear Sir,

We are working as asst professor in the department of CIVIL ENGINEERING. Sir, we are going to conduct three weeks workshop on ETABS. We require your approval to go head for further proceeding and hope to get an opportunity to serve you the best .

With thanks and Regards



K. Srinivas
PRINCIPAL
MAHAVEER
INSTITUTE OF SCIENCE & TECHNOLOGY
Bandlaguda, Hyderabad-500005.

From,
Civil Department
Mist,
Bandlaguda,

Vysapuri, Bandlaguda Post:Keshavgirl,
Hyderabad-500 005, Telangana INDIA
Tel: 040-64596979,20620773, Fax: 040-24455003
E-mail: principal.mahaveer@gmail.com,
Website: www.mist.ac.in,

MAHAVEER
INSTITUTE OF SCIENCE & TECHNOLOGY
Approved by AICTE, Affiliated to JNTUH,Hyd.



DEPARTMENT OF CIVIL ENGINEERING

CIRCULAR

Hyderabad.

Date: 22.08.2017

Technical Training for III B. Tech students are starting from 22 -08- 2017 onwards. All HODs and Placements coordinators have to manage the trainings and ensure 95% attendance all through the sessions.

All Mentors need to send the compiled feedback report to Ch.Swethamber, HOD at c3hod.civil@gmail.com daily.

Agenda: 1. Introduction to ETABS.

CHLSWETHAMBER

HOD



Designed by : M.VASANTHALAXMI

B RAJASEKHAR

Principil
PRINCIPIL
MAHAVEER
INSTITUTE OF SCIENCE & TECHNOLOGY
Bandlaguda, Hyd-500 005



DEPARTMENT OF CIVIL ENGINEERING

ETABS SYLLABUS

- 1: The knowledge about specialized software such as ETABS, SAFE to model and analyze for buildings.
- 2: Be able to model, analyze, and solve structural models on Specialized software and access analysis results such as force, Displacement and another parameter for structural design.
- 3: Be able to communicate and work in the group flexibly and Efficiently.
- 4: Explaining concepts, terminology and rules used in ETABS, SAFE software.
- 5: Modeling and analyzing type of simple and complex structural Systems.
- 6: Analyzing and determining the values of internal forces, Displacements and other parameters for structural design.
- 7: Working in the group to solve the problems relates to using Software ETABS, SAFE.
- 8: Choosing appreciable communication skills such as speech, Text, images, graphics, when expressing personal views.



Keshav
PRINCIPAL
MAHAVEER
INSTITUTE OF SCIENCE & TECHNOLOGY
Bandlaguda, Hyderabad - 500 005.

Vysapuri, Bandlaguda Post:Keshavgirl,
Hyderabad-500 005, Telangana INDIA
Tel: 040-64596979,20020773, Fax: 040-24455003
E-mail: principal.mahaveer@gmail.com,
Website: www.mist.ac.in,

MAHAVEER
INSTITUTE OF SCIENCE & TECHNOLOGY
Approved by AICTE, Affiliated to JNTUH,Hyd



DEPARTMENT OF CIVIL ENGINEERING
ETABS Technical Training student Marks list 2017-18

S.No	Hall Ticket No	Name of the Candidate
1	I5E31A0101	A DIVISHA
2	I5E31A0103	BAGUROTHUSAIUJWALA
3	I5E31A0108	CHANDAVENKATESH
4	I5E31A0109	DHADIVIJAY
5	I5E31A0111	ELISHETTY TEJASWINI
6	I5E31A0112	ERUKULLASRIKANTH
7	I5E31A0115	GOPIPRANAY
8	I5E31A0117	LOKASANISURENDERREDDY
9	I5E31A0118	M AVINASHI
10	I5E31A0119	MADIRENARESH
11	I5E31A0120	MD ABDULMUNAM
12	I5E31A0121	MD SALMAN CHOUDHARY
13	I5E31A0122	MOHAMMED ETHESHAM



Kishu

PRINCIPAL
MAHAVEER
INSTITUTE OF SCIENCE & TECHNOLOGY
Bandlaguda, Hyderabad - 500 005

Vysapuri, Bandlaguda Post:Keshavgiri,
Hyderabad-500 005, Telangana INDIA
Tel: 040-64596979,20020773, Fax: 040-24455003
E-mail: principal.mahaveer@gmail.com,
Website: www.mist.ac.in,

MAHAVEER

INSTITUTE OF SCIENCE & TECHNOLOGY
Approved by AICTE, Affiliated to JNTUH, Hyd.



14	15E31A0123	MOHDAHMED
15	15E31A0124	MUBARAK ALDAYANI
16	15E31A0125	NENAVATH SANTHOSH
17	15E31A0130	PITTALA RAJESH KUMAR
18	15E31A0131	SABIRALIE
19	15E31A0133	SHEELAM PRAMOD KUMAR
20	15E31A0134	SIDDINICHANDU
21	15E31A0140	VADLASHIRAVAN KUMAR
22	15E31A0142	ZEESHAN ASHIRAF
23	15E31A0143	M A KHADERANSARI
24	15E31A0144	PALAJUSRICHAITHANYA
25	15E31A0145	GOLLAVISHNUYADAV
26	16E35A0101	GADDAM CHARAN
27	16E35A0102	GUNDALAMANISHI
28	16E35A0103	JANAPATIRAVI
29	16E35A0104	M PRASHANTH
30	16E35A0105	M. RANJITHA
31	16E35A0107	P.PRAVALIKA
32	16E35A0108	POGAKUKEERTHIMADIHURI



K. S. S. S.
PRINCIPAL
MAHAVEER
INSTITUTE OF SCIENCE & TECHNOLOGY
Bandlaguda, Hyd.

Vysapuri, Bandlaguda Post:Keshavgi,
Hyderabad-500 005, Telangana INDIA
Tel: 040-64596979,20020773, Fax: 040-24455003
E-mail: principal.mahaveer@gmail.com,
Website: www.mist.ac.in,

MAHAVEER

INSTITUTE OF SCIENCE & TECHNOLOGY
Approved by AICTE, Affiliated to JNTUH,Hyd.



33	16E35A0109	REDAPAKA MAHESHWARI
34	14E31A0102	ABDURRAHEEMMUNAWWAR
35	14E31A0133	MOHAMMED ABDULALIFUZAIL

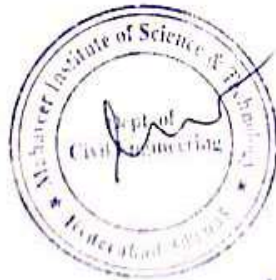

Keshavgi

PRINCIPAL
MAHAVEER
INSTITUTE OF SCIENCE & TECHNOLOGY
Bandlaguda, Hyderabad-500005.

MAHAVEER INSTITUTE OF SCIENCE & TECHNOLOGY, HYDERABAD

CIVIL ENGINEERING STUDENTS ATTENDANCE

B.TECH III YEAR I SEM I SEM 2017-2018 BATCH (Date : 22-08-2017 to 01-09-2017)

S.No	Hall Ticket No	Name of the Candidate	1	2	3	4	5	6	7	8	9	10
1	15E31A0101	A DIVISHA	P	P	A	P	P	P	P	P	A	P
2	15E31A0105	BAGUROTHU SAUJWALA	A	P	P	P	A	P	P	P	P	P
3	15E31A0108	CHANDA VENKATESH	P	P	P	A	P	A	P	P	P	P
4	15E31A0109	DHADI VIJAY	P	P	P	P	A	P	P	P	P	A
5	15E31A0111	ELISHETTY TEJASWINI	A	P	P	P	P	A	P	P	A	P
6	15E31A0112	ERUKULLA SRIKANTH	P	A	P	P	A	P	P	P	P	P
7	15E31A0115	GOPI PRANAY	P	P	P	P	P	A	P	A	P	P
8	15E31A0117	LOKASANI SURENDER REDDY	P	A	A	P	P	P	P	P	P	P
9	15E31A0118	M AVINASHI	P	P	P	P	P	P	P	A	P	P
10	15E31A0119	MADIRE NARESH	P	P	A	P	A	P	P	P	P	P
11	15E31A0120	MD ABDUL MUNAM MD SALMAN	P	A	P	P	P	P	A	P	A	P
12	15E31A0121	CHIOUDIARY	P	P	P	A	P	P	A	P	P	P

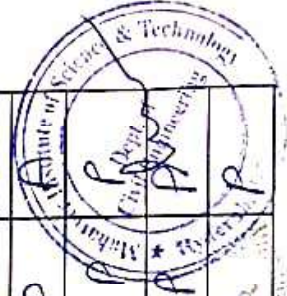

MAHAVEER INSTITUTE OF SCIENCE & TECHNOLOGY
HYDERABAD
DEPT. OF CIVIL ENGINEERING

29	16E35A0104	M PRASHANTH	P	P	P	P	A	P	P	P	P
30	16E35A0105	M. RANJITHA	P	P	P	P	A	P	P	P	P
31	16E35A0107	P. PRAVALIKA	P	P	P	P	P	A	P	P	P
32	16E35A0108	POGAKU KEERTHI MADHURI	P	P	P	P	P	P	P	P	P
33	16E35A0109	REDAPAKA MAHESHWARI	A	P	P	P	P	A	P	P	P
34	14E31A0102	ABDUR RAHEEM MUNNAWAR	P	P	P	P	P	A	P	P	P
35	14E31A0133	MOHD ABDUL ALLI FUZAIL	A	P	P	P	P	P	P	P	P



K. Srinivas
 PRINCIPAL
 Government of Karnataka
 Bangalore

Vysapuri, Bandlaguda Post:Keshavgi,
Hyderabad-500 005, Telangana INDIA
Tel: 040-64596979,20020773, Fax: 040-24455003
E-mail: principal.mahaveer@gmail.com,
Website: www.mist.ac.in,

MAHAVEER
INSTITUTE OF SCIENCE & TECHNOLOGY
Approved by AICTE, Affiliated to JNTUH,Hyd.



DEPARTMENT OF CIVIL ENGINEERING

Technical Training Exam on Etabs Software

(A.Y-2017-18)

2x10=20 Marks

Answer All the Questions

1) Design of composite steel using etabs

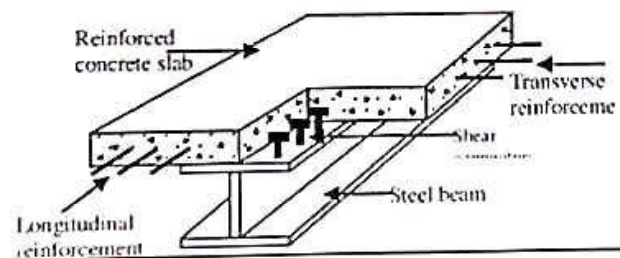

2) composite coloum using etabs



K. Srinivas
PRINCIPAL
MAHAVEER
INSTITUTE OF SCIENCE & TECHNOLOGY
Bandlaguda, Hyderabad-500 005.

Vysapuri, Bandlaguda Post:Keshavgi,
Hyderabad-500 005, Telangana INDIA
Tel: 040-64596979,20020773..Fax: 040-24455003
E-mail: principal.mahaveer@gmail.com,
Website: www.mist.ac.in,

MAHAVEER

INSTITUTE OF SCIENCE & TECHNOLOGY
Approved by AICTE, Affiliated to JNTUH,Hyd.

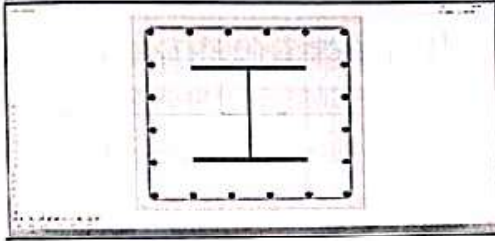

DEPARTMENT OF CIVIL ENGINEERING

Department of Mechanical Engineering ETABS Technical Training student Marks list 2017-18

Sl.NO	Hall Ticket No	Name of the Candidate	YEAR	MARKS	PASS/FAIL
1	15E31A0101	A DIVISHA	III	16	PASS
2	15E31A0103	BAGUROTHUSAIUJWALA	III	16	PASS
3	15E31A0108	CHANDAVENKATESH	III	12	PASS
4	15E31A0109	DHADIVIJAY	III	12	PASS
5	15E31A0111	ELISHETTY TEJASWINI	III	16	PASS
6	15E31A0112	ERUKULLASRIKANTH	III	16	PASS
7	15E31A0115	GOPIPRANAY	III	16	PASS
8	15E31A0117	LOKASANISURENDERREDDY	III	16	PASS
9	15E31A0118	M AVINASHI	III	16	PASS
10	15E31A0119	MADIRENARESHI	III	16	PASS
11	15E31A0120	MD ABDULMUNAM	III	16	PASS
12	15E31A0121	MD SALMAN CHOUDHARY	III	16	PASS



K. S. S. S.
PRINCIPAL
MAHAVEER
INSTITUTE OF SCIENCE & TECHNOLOGY
bandlaguda, Hyd-500 005.

Vysapurli, Bandlaguda Post, Keshavnagar,
Hyderabad-509 005, Telangana INDIA
Tel: 040-84696379, 20020773, Fax: 040-24455003
E-mail: principal.mahaveer@gmail.com
Website: www.mist.ac.in

MAHAVEER

INSTITUTE OF SCIENCE & TECHNOLOGY
Approved by AICTE, Affiliated to JNTUH, Hyd.



13	15E31A0122	MOHAMMED ETHESHAM	III	16	PASS
14	15E31A0123	MOHDAHMED	III	16	PASS
15	15E31A0124	MUBARAK ALDAYANI	III	16	PASS
16	15E31A0125	NENAVATHI SANTHOSH	III	16	PASS
17	15E31A0130	PITTALA RAJESH KUMAR	III	16	PASS
18	15E31A0131	SABIRALIE	III	16	PASS
19	15E31A0133	SHEELAM PRAMOD KUMAR	III	15	PASS
20	15E31A0134	SIDDINICHANDU	III	16	PASS
21	15E31A0140	VADLASHIRAVAN KUMAR	III	16	PASS
22	15E31A0142	ZEESHAN ASHRAF	III	15	PASS
23	15E31A0143	M A KHADERANSARI	III	16	PASS
24	15E31A0144	PALAJUSRICHAITHANYA	III	14	PASS
25	15E31A0145	GOLLAVISINUYADAV	III	15	PASS
26	16E35A0101	GADDAM CHARAN	III	15	PASS
27	16E35A0102	GUNDALAMANISHI	III	16	PASS
28	16E35A0103	JANAPATIRAVI	III	14	PASS
29	16E35A0104	M PRASHANTI	III	16	PASS
30	16E35A0105	M. RANJITHA	III	15	PASS
31	16E35A0107	P.PRAVALIKA	III	14	PASS
32	16E35A0108	POGAKUKERTHIMADIHURI	III	18	PASS
33	16E35A0109	REDAPAKA MAHESHWARI	III	15	PASS
34	14E31A0102	ABDURRAHEEMHUNAWWAR	III	16	PASS
35	14E31A0133	MOHAMMED ABDULALIFUZAIL	III	15	PASS



K. Srinivas
PRINCIPAL
MAHAVEER
INSTITUTE OF SCIENCE & TECHNOLOGY
Bandlaguda, Hyd-509 005.

Vysapuri, Bandlaguda Post:Keshavgiri,
Hyderabad-500 005, Telangana INDIA
Tel: 040-84598979,20020773, Fax: 040-24455003
E-mail: principal.mahaveer@gmail.com,
Website: www.mist.ac.in,

MAHAVEER

INSTITUTE OF SCIENCE & TECHNOLOGY
Approved by AICTE, Affiliated to JNTUH,Hyd.



DEPARTMENT OF CIVIL ENGINEERING

Etabs course

Summary

Department of Civil Engineering

- Use ETABS for daily working process.
- Navigate throughout ETABS using major navigating tools.
- Understand the concept and techniques to draw.
- Create multiple designs using several of tools.
- Create layers to control the objects' visibility.
- Explain drawing using annotations.
- To use constraint for certain design.



K. Srinivas
PRINCIPAL
MAHAVEER
INSTITUTE OF SCIENCE & TECHNOLOGY
Bandlaguda Post, Keshavgiri, Hyderabad-500 005

Vysapuri, Bandlaguda Post:Keshavgiri,
Hyderabad-500 005, Telangana INDIA
Tel: 040-64598379,20020773, Fax: 040-24455003
E-mail: principal.mahaveer@gmail.com,
Website: www.mist.ac.in,

MAHAVEER

INSTITUTE OF SCIENCE & TECHNOLOGY
Approved by AICTE, Affiliated to JNTUH,Hyd.



CERTIFICATE OF COURSE COMPLETION

This certificate is presented to _____ of MIST, who has successfully completed technical training course on "ETABS" held from _____ to _____ and found the student performance to be excellent.



ESTD : 2001

CILSWETHAMBER

HOD

Civil Department

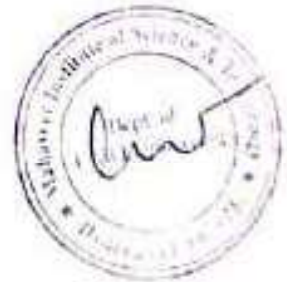

K. Kishore
PRINCIPAL
MAHAVEER
INSTITUTE OF SCIENCE & TECHNOLOGY
Vysapuri, Bandlaguda Post, Hyderabad-500 005.

Vysapuri, Bandlaguda Post:Keshavgiri,
Hyderabad-500 005, Telangana INDIA
Tel: 040-64596979,20020773, Fax: 040-24455003
E-mail: principal.mahaveer@gmail.com,
Website: www.mist.ac.in,

MAHAVEER

INSTITUTE OF SCIENCE & TECHNOLOGY

Approved by AICTE, Affiliated to JNTUH,Hyd.



PROPOSAL LETTER

Hyderabad,

25/08/2017.

To,
The principal,
MIST,
Hyderabad.

Sub: Proposal for three weeks workshop on GEO5-Reg,

Dear Sir,

We are working as asst professor in the department of CIVIL ENGINEERING. Sir, we are going to conduct three weeks workshop on GEO5. We require your approval to go head for further proceeding and hope to get an opportunity to serve you the best .

With thanks and Regards

From,
Civil Department
Mist,
Bandlaguda,
Hyderabad.



Kishu

PRINCIPAL
MAHAVEER
INSTITUTE OF SCIENCE & TECHNOLOGY
Bandlaguda, Hyd-500 005

Vysapuri, Bandlaguda Post:Keshavgiri,
Hyderabad-500 005, Telangana INDIA
Tel: 040-64596979,20020773, Fax: 040-24455003
E-mail: principal.mahaveer@gmail.com,
Website: www.mist.ac.in,

MAHAVEER
INSTITUTE OF SCIENCE & TECHNOLOGY
Approved by AICTE, Affiliated to JNTUH,Hyd.



Date: 01.09.2017

CIRCULAR

Technical Training for II B. Tech students are starting from 20th SEPTEMBER, 2017 onwards.
All HODs and Placements coordinators have to manage the trainings and ensure 95% attendance
all through the sessions.

All Mentors need to send the compiled feedback report to CH.SWETHAMBER, HOD at
e3hod.civil@gmail.com daily.

Agenda: 1. Introduction to GEO5 SOFTWARE

CH.SWETHAMBER
HOD

Design by: B.RAMANA KUMAR
B.RAJASHEKAR

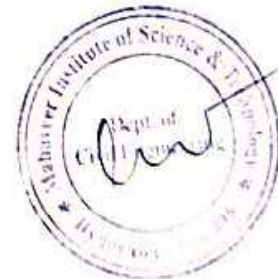

PRINCIPAL
MAHAVEER
INSTITUTE OF SCIENCE & TECHNOLOGY
bandlaguda, Hyd-500 005.

Vysapuri, Bandlaguda Post-Kosavgirl,
Hyderabad-509 005, Telangana INDIA
Tel: 040-64596979, 20920773, Fax: 040-24455003
E-mail: principal.mahaveer@gmail.com
Website: www.mst.ac.in,

MAHAVEER
INSTITUTE OF SCIENCE & TECHNOLOGY
Approved by AICTE, Affiliated to JNTUH,Hyd.



GEO5 SYLLABUS

Getting started with GEO5 SOFTWARE

- 1) Design of a cantilever wall
- 2) Verification of a gravity wall
- 3) Design of a non-anchored retaining wall
- 4) Design of an anchored retaining wall
- 5) Verification of a multi anchored wall
- 6) Slope stability analysis
- 7) Design of the geometry of a spread footing
- 8) Settlement of a spread footing
- 9) Analysis of a consolidation under embankment
- 10) Pile foundations-introduction

PRINCIPAL
MAHAVEER
INSTITUTE OF SCIENCE & TECHNOLOGY
Bandlaguda, Hyderabad-509005



Vysapuri, Bandlaguda Post:Keshavgi,
Hyderabad-500 005, Telangana INDIA
Tel: 040-64596979,20020773, Fax: 040-24455003
E-mail: principal.mahaveer@gmail.com,
Website: www.mist.ac.in,

MAHAVEER

INSTITUTE OF SCIENCE & TECHNOLOGY

Approved by AICTE, Affiliated to JNTUH,Hyd.



MAHAVEER INSTITUTE OF SCIENCE & TECHNOLOGY, HYDERABAD			
B.TECH IV YEAR I SEM			
CIVIL ENGINEERING 2017-18 BATCH			
S.No	Hall Ticket No	Name of the Candidate	Year
1	14E31A0101	A SRIKANTH	IV
2	14E31A0103	AMBATI NEELIMA	IV
3	14E31A0104	ANKITH KUMAR TIWARI	IV
4	14E31A0105	AREF ABDUR RAHMAN AL KASERI	IV
5	14E31A0106	AVULA AJAYA LAKSHMI	IV
6	14E31A0107	BATHARAJU ARUN KUMAR	IV
7	14E31A0108	BATTIINI VINAY	IV
8	14E31A0109	BEJJURI PRASHANTH	IV
9	14E31A0111	BOINPELLI SHRUTHI	IV
10	14E31A0112	BUDUGULA KIRAN KUMAR	IV
11	14E31A0113	CHITIKESHI OMPRAKASHI	IV
12	14E31A0114	EPPA OMPRAKASHI	IV
13	14E31A0115	FAIZAN BAIG	IV
14	14E31A0116	GADDAVARI SHIVA KRISHINA	IV
15	14E31A0117	GANDLA SUHRUDH	IV
16	14E31A0118	GORLA SHRAVANI	IV
17	14E31A0119	GOTTE TEJASWEI	IV
18	14E31A0120	ISLAVATH PAVANKUMAR	IV
19	14E31A0121	JADHAV SAI KRISHINA	IV

K. Subh
PRINCIPAL
MAHAVEER
INSTITUTE OF SCIENCE & TECHNOLOGY
Bandlaguda, Hyderabad.



20	14E31A0122	KONUGANTI NIKHIL REDDY	IV
21	14E31A0123	MAJJARI CHANDRA SHEKHAR	IV
22	14E31A0124	MASARATH JAHAN	IV
23	14E31A0125	MEKAPOTHULA SANDEEP	IV
24	14E31A0126	MIR SIDDIQ MUQTADIR ALI HASHIMI	IV
25	14E31A0127	MOGILI LIKHITHA	IV
26	14E31A0128	MOGULAM ROHITH	IV
27	14E31A0129	MOHAMMED AIRAJ MOHIUDDIN	IV
28	14E31A0130	MOHAMMED ASIM SULEMAN	IV
29	14E31A0131	MOHAMMED JAWAD UDDIN	IV
30	14E31A0134	MOHD ABDUL RAOOF	IV
31	14E31A0136	MOHD IBRAHIMA FARUQE	IV
32	14E31A0137	MOHD MOHIUDDIN FAIZ	IV
33	14E31A0139	NAARSING AISHWARYA	IV
34	14E31A0140	NIMMALA THIRUPATHI	IV
35	14E31A0141	PALAM SRIKANTH REDDY	IV
36	14E31A0142	PERAPOGU SHASHI KIRAN	IV
37	14E31A0144	RAVINTHALA NARENDRA BABU	IV
38	14E31A0145	SAYYAD SOHEL	IV
39	14E31A0147	SHAIK RAHIL FARAZ	IV
40	14E31A0148	SILUVERI MADHUKAR	IV
41	14E31A0149	SOMA SRILATHA	IV
42	14E31A0150	SYED ISMAIL	IV
43	14E31A0151	SYED KALEEM ULLAH QUADRI	IV
44	14E31A0152	SYED MOHAMMED FIRDOUSE	IV

PRINCIPAL
MAHAVEER
 INSTITUTE OF SCIENCE & TECHNOLOGY
 Bandlaguda, Hyd-500 002

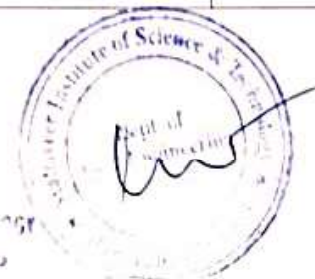

45	14E31A0153	SYED MUSTAFA ALI	IV
46	14E31A0154	SYED NUMAN	IV
47	14E31A0155	SYED SAAD SHAREEF	IV
48	14E31A0157	VAISHNAVI UPADHYAY	IV
49	14E31A0158	VANAPARTHI SANTHOSH VARMA	IV
50	14E31A0159	VEMULA AVINASHI	IV
51	15E35A0101	ALTAF AHMED	IV
52	15E35A0102	B SAI KRISHNA	IV
53	15E35A0103	BORRA RAGHU RAM	IV
54	15E35A0104	GANGULA RATHINA KUMAR	IV
55	15E35A0105	KASTHOORI VENKATAKRISHNA	IV
56	15E35A0106	MD JUNED	IV
57	15E35A0107	METHUKU SAGAR REDDY	IV
58	15E35A0108	MOHAMMED NADEEMUDDIN	IV
59	15E35A0109	NALLA SHESHU VARDHAN REDDY	IV
60	15E35A0110	NALLAPU VEERA HANUMANATHA RAO	IV
61	15E35A0112	V KAVITHA	IV
62	13E31A0102	ABDUL RAHMAN BIN HASSAN AL YAFAI	IV
63	13E31A0105	AMBALA RAJKUMAR	IV
64	13E31A0138	MUSKU SANTOSH	IV
65	13E31A0113	DABBA ROHITH	IV

K. Srinivas

PRINCIPAL
MAHAVEER
INSTITUTE OF SCIENCE & TECHNOLOGY
Bandlaguda, Hyderabad



MAHAVEER INSTITUTE OF SCIENCE & TECHNOLOGY, HYDERABAD
CIVIL ENGINEERING STUDENTS ATTENDANCE

B.TECH IV YEAR I SEM I 2017-2018 BATCH (Date :20-09-2017 to 30-10-2017)

S.No	Hall Ticket No	Name of the Candidate	1	2	3	4	5	6	7	8	9	10
1	14E31A0101	A SRIKANTH	P	P	P	A	P	P	P	P	A	P
2	14E31A0103	AMBATI NEELIMA	A	P	P	P	P	P	P	P	P	P
3	14E31A0104	ANKITH KUMAR TIWARI	P	P	P	P	P	P	A	P	P	P
4	14E31A0105	ARIF ABDUR RAHMAN AL KASERI	P	P	P	P	P	P	P	P	A	P
5	14E31A0106	AVULA AJAYA LAKSHMI	A	P	P	P	P	P	P	P	P	P
6	14E31A0107	BATHARAJU ARUN KUMAR	P	P	P	P	P	P	P	P	P	P
7	14E31A0108	BATTHINIVINAY	P	P	P	P	P	P	P	P	P	A
8	14E31A0109	BEJU RUPRASHANTH	P	P	P	P	P	P	P	P	P	P
9	14E31A0111	ROINPELLESHRUTHI	P	P	P	P	P	P	P	P	P	P
10	14E31A0112	RUDUGULA KIRAN KUMAR	P	P	P	P	P	A	P	P	P	P
11	14E31A0113	CHITIKESHI OMPRAKASH	P	P	P	P	P	P	P	P	A	P
12	14E31A0114	EPPA OMPRAKASH	P	P	P	P	P	P	P	P	P	P
13	14E31A0115	FAIZAN BAIG	P	P	P	P	P	P	P	P	P	P
14	14E31A0116	GADDAV ARISHIVA KRISHNA	P	P	P	P	P	P	P	P	P	P
15	14E31A0117	GANDLA SUHRUDH	P	P	P	P	P	P	P	P	P	P
16	14E31A0118	GORLA SHRAVANI	P	P	P	P	P	P	P	P	P	P
17	14E31A0119	GOTTE TEJASWEI	P	P	P	P	P	P	A	P	P	P
18	14E31A0120	ISLAVATH PAVANKUMAR	P	A	P	P	P	P	P	P	P	P
19	14E31A0121	JADHAV SAI KRISHNA	P	P	P	P	P	P	P	P	P	P
20	14E31A0122	KONUGANTI NIKHIL REDDY	P	P	A	P	P	P	P	A	P	P
21	14E31A0123	MAJJARI CHANDRA SHEKHAR	P	P	P	P	P	P	P	P	P	P
22	14E31A0124	MASARATH JAHAN	P	A	P	P	P	A	P	P	P	P
23	14E31A0125	MEKAPOTHULA SANDEEP	P	P	P	P	P	P	P	P	P	P
24	14E31A0126	MIR SIDDIQ MUQTADIR ALI HASHMI	P	P	P	P	P	P	P	P	P	P
25	14E31A0127	MOGGILI LIKHITHA	P	P	P	P	P	P	P	P	P	P
26	14E31A0128	MOGULAM ROHITH	A	P	P	P	A	P	P	P	P	P
27	14E31A0129	MOHAMMED AIRAJ MOHUDDIN	P	P	P	P	P	A	P	P	P	P
28	14E31A0130	MOHAMMED ASIM SULLEMAN	P	P	P	P	P	P	P	P	P	P
29	14E31A0131	MOHAMMED JAWAD UDDIN	P	P	P	P	P	P	P	P	P	P
30	14E31A0134	MOHD ABDUL KAOOF	A	P	P	P	P	P	P	P	P	P
31	14E31A0136	MOHD IBRAHIMA FARUQE	P	P	P	P	P	P	P	P	P	P
32	14E31A0137	MOHD MOHIUDDIN FAIZ	P	P	P	P	P	P	P	P	P	A



PRINCIPAL
MAHAVEER
INSTITUTE OF SCIENCE & TECHNOLOGY
 Bandlaguda, Hyd-500 005.

Vysapuri, Bandlaguda Post:Keshavgi,
Hyderabad-500 005, Telangana INDIA
Tel: 040-64596979,20020773, Fax: 040-24455003
E-mail: principal.mahaveer@gmail.com,
Website: www.mist.ac.in,

MAHAVEER
INSTITUTE OF SCIENCE & TECHNOLOGY
Approved by AICTE, Affiliated to JNTUH,Hyd.



Technical Training Exam on GEOS Software
(A.Y-2017-18)

2x10=20 Marks

Answer All the Questions

1. What is FLAC SOFTWARE ?
2. What is optum G2?

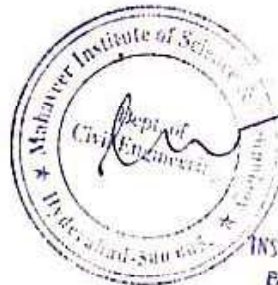

K. S. S. S.
PRINCIPAL
MAHAVEER
INSTITUTE OF SCIENCE & TECHNOLOGY
Bandlaguda, Hyd-500 005.

Vysapuri, Bandlaguda Post:Keshavgiri,
Hyderabad-500 005, Telangana INDIA
Tel: 040-64596979,20020773, Fax: 040-24455003
E-mail: principal.mahaveer@gmail.com,
Website: www.mist.ac.in,

MAHAVEER
INSTITUTE OF SCIENCE & TECHNOLOGY
Approved by AICTE, Affiliated to JNTUH,Hyd.



MAHAVEER INSTITUTE OF SCIENCE & TECHNOLOGY, HYDERABAD					
B.TECH IV YEAR I SEM					
CIVIL ENGINEERING 2017-18 BATCH					
S.No	Hall Ticket No	Name of the Candidate	Year	Marks	Pass/Fail
1	14E31A0101	A SRIKANTH	IV	16	Pass
2	14E31A0103	AMBATI NEELIMA	IV	15	Pass
3	14E31A0104	ANKITH KUMAR TIWARI	IV	14	Pass
4	14E31A0105	AREF ABDUR RAHMAN AL KASERI	IV	15	Pass
5	14E31A0106	AVULA AJAYA LAKSHMI	IV	12	Pass
6	14E31A0107	BATHARAJU ARUN KUMAR	IV	13	Pass
7	14E31A0107	BATHARAJU ARUN KUMAR	IV	14	Pass
8	14E31A0108	BATTHINI VINAY	IV	16	Pass
9	14E31A0109	BEJJURI PRASHANTH	IV	15	Pass
10	14E31A0111	BOINPELLI SHRUTHI	IV	14	Pass
11	14E31A0112	BUDUGULA KIRAN KUMAR	IV	13	Pass
12	14E31A0113	CHITIKESHI OMPRAKASHI	IV	14	Pass
13	14E31A0114	EPPA OMPRAKASHI	IV	14	Pass
14	14E31A0115	EPPA OMPRAKASHI	IV	12	Pass
15	14E31A0115	FAIZAN BAIG	IV	15	Pass
16	14E31A0116	GADDAVARI SHIVA KRISHNA	IV	15	Pass
17	14E31A0116	GADDAVARI SHIVA KRISHNA	IV	14	Pass
18	14E31A0117	GANDLA SUHRUDI	IV	14	Pass
19	14E31A0117	GANDLA SUHRUDI	IV	15	Pass
20	14E31A0118	GORLA SHRAVANI	IV	15	Pass
21	14E31A0118	GORLA SHRAVANI	IV	14	Pass
22	14E31A0119	GOTTE TEJASWEI	IV	14	Pass

Keshav
500 005, Keshavgiri,
Hyderabad-500 005, Telangana INDIA
MAHAVEER
INSTITUTE OF SCIENCE & TECHNOLOGY
Approved by AICTE, Affiliated to JNTUH,Hyd.

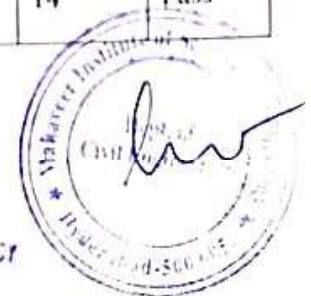

18	14E31A0120	ISLAVATHI PAVANKUMAR	IV	12	Pass
19	14E31A0121	JADHAV SAI KRISHNA	IV	15	Pass
20	14E31A0122	KONUGANTI NIKHIL REDDY	IV	16	Pass
21	14E31A0123	MAJJARI CHANDRA SHEKHAR	IV	15	Pass
22	14E31A0124	MASARATH JAHAN	IV	14	Pass
23	14E31A0125	MEKAPOTHULA SANDEEP	IV	15	Pass
24	14E31A0126	MIR SIDDIQ MUQTADIR ALI HASHMI	IV	16	Pass
25	14E31A0127	MOGILI LIKHITHA	IV	15	Pass
26	14E31A0128	MOGULAM ROHITH	IV	14	Pass
27	14E31A0129	MOHAMMED AIRAJ MOHIUDDIN	IV	15	Pass
28	14E31A0130	MOHAMMED ASIM SULEMAN	IV	12	Pass
29	14E31A0131	MOHAMMED JAWAD UDDIN	IV	13	Pass
30	14E31A0134	MOHD ABDUL RAOOF	IV	14	Pass
31	14E31A0136	MOHD IBRAHIMA FARUQE	IV	12	Pass
32	14E31A0137	MOHD MOHIUDDIN FAIZ	IV	16	Pass
33	14E31A0139	NAARSING AISHWARYA	IV	15	Pass
34	14E31A0140	NIMMALA THIRUPATHI	IV	13	Pass
35	14E31A0141	PALAM SRIKANTH REDDY	IV	12	Pass
36	14E31A0142	PERAPOGU SHASHI KIRAN	IV	13	Pass
37	14E31A0144	RAVINOTHALA NARENDRA BABU	IV	15	Pass
38	14E31A0145	SAYYAD SOHEL	IV	16	Pass
39	14E31A0147	SHAIK RAHIL FARAZ	IV	14	Pass
40	14E31A0148	SILVERI MADHUKAR	IV	12	Pass
41	14E31A0149	SOMA SRILATHA	IV	13	Pass
42	14E31A0150	SYED ISMAIL	IV	13	Pass

PRINCIPAL
MAHAVEER
 INSTITUTE OF SCIENCE & TECHNOLOGY
 Bangalore, 11st 500 022



43	14E31A0151	SYED KALEEM ULLAH QUADRI	IV	15	Pass
44	14E31A0152	SYED MOHAMMED FIRDOUSE	IV	16	Pass
45	14E31A0153	SYED MUSTAFA ALI	IV	14	Pass
46	14E31A0154	SYED NUMAN	IV	15	Pass
47	14E31A0155	SYED SAAD SHAREEF	IV	13	Pass
48	14E31A0157	VAISHNAVI UPADHYAY	IV	12	Pass
49	14E31A0158	VANAPARTHI SANTHOSH VARMA	IV	12	Pass
50	14E31A0159	VEMULA AVINASHI	IV	15	Pass
51	13E31A0102	ABDUL RAHMAN BIN HASSAN AL YAFAI	IV	15	Pass
52	15E35A0101	ALTAF AHMED	IV	16	Pass
53	15E35A0102	B SAI KRISHNA	IV	12	Pass
54	15E35A0103	BORRA RAGHU RAM	IV	13	Pass
55	15E35A0104	GANGULA RATINA KUMAR	IV	15	Pass
56	15E35A0105	KASTHOORI VENKATAKRISHNA	IV	16	Pass
57	15E35A0106	MD JUNED	IV	16	Pass
58	15E35A0107	METHUKU SAGAR REDDY	IV	15	Pass
59	15E35A0108	MOHAMMED NADEEMUDDIN	IV	13	Pass
60	15E35A0109	NALLA SHESHU VARDHAN REDDY	IV	14	Pass
61	15E35A0110	NALLAPU VEERA HANUMANTHA RAO	IV	14	Pass
62	15E35A0112	V KAVITHA	IV	12	Pass
63	13E31A0103	ABDUL RAHMAN BIN HASSAN AL YAFAI	IV	12	Pass
64	13E31A0105	AMBALA RAJKUMAR	IV	13	Pass
65	13E31A0138	MUSKU SANTOSHI	IV	12	Pass
66	13E31A0113	DABBA ROHITHI	IV	13	Pass

PRINCIPAL
MAHAVEER
 INSTITUTE OF SCIENCE & TECH
 Bankalaguda, Hyd-500 005.



Vysapuri, Bandlaguda Post:Keshavnagar,
Hyderabad-500 005, Telangana INDIA
Tel: 040-54596979,20020773, Fax: 040-24455003
E-mail: principal.mahaveer@gmail.com,
Website: www.mist.ac.in,

MAHAVEER
INSTITUTE OF SCIENCE & TECHNOLOGY
Approved by AICTE, Affiliated to JNTU(Hyd).



GEO5 COURSE
Summary

Department of Civil Engineering

- Use GEO5 for daily working process.
- Navigate throughout GEO5 using major navigating tools.
- Understand the concept and techniques to draw.
- Create multiple designs using several of tools.
- Create layers to control the objects' visibility.
- Explain drawing using annotations.
- Plot or print the drawing by scale.
- To use constraint for certain design.

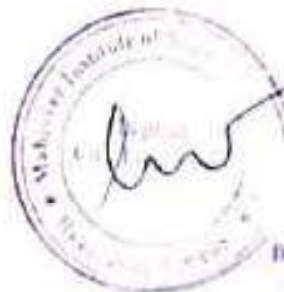

Kishor
PRINCIPAL
MAHAVEER
INSTITUTE OF SCIENCE & TECHNOLOGY
Bandlaguda, Hydr 500 005.

Vysapuri, Bandlaguda Post:Keshavgi,
Hyderabad-500 005, Telangana INDIA
Tel: 040-64596979,20020773, Fax: 040-24455003
E-mail: principal.mahaveer@gmail.com,
Website: www.mist.ac.in,

MAHAVEER
INSTITUTE OF SCIENCE & TECHNOLOGY
Approved by AICTE, Affiliated to JNTUH,Hyd.



CERTIFICATE OF COURSE COMPLETION

This certificate is presented to _____ of MIST, who has successfully completed technical training course on "GEO5" held from _____ to _____ and found the student performance to be excellent.



ESTD : 2001

CH.SWETHAMBER

HOD



Kshiraj

PRINCIPAL
MAHAVEER
INSTITUTE OF SCIENCE & TECHNOLOGY
Bandlaguda, Hyd-500 005.

Vysapuri, Bandlaguda Post:Keshavnagar,
Hyderabad-500 005, Telangana INDIA
Tel: 040-94596979,20020773, Fax: 040-24455003
E-mail: principal.mahaveer@gmail.com,
Website: www.mist.ac.in,

MAHAVEER

INSTITUTE OF SCIENCE & TECHNOLOGY

Approved by AICTE, Affiliated to JNTUH, Hyd.



PROPOSAL LETTER

Hyderabad,

08/03/2017.

To
The principal,
MIST,
Hyderabad.

Sub: Proposal for three weeks workshop on STADD PROVIS-Reg.

Dear Sir,

We are working as asst professor in the department of CIVIL ENGINEERING. Sir,
we are going to conduct three weeks workshop on STADD PROVIS. We require your
approval to go head for further proceeding and hope to get an opportunity to serve you
the best .

With thanks and Regards

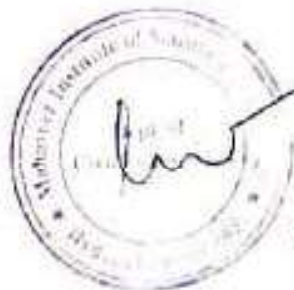

**PRINCIPAL
MAHAVEER**
INSTITUTE OF SCIENCE & TECHNOLOGY
BANDLAGUDA, HYDERABAD

From,
Civil Department,
Mist,
Bandlaguda,
Hyderabad.

Vysapuri, Bandlaguda Post:Keshavgi,
Hyderabad-500 005, Telangana INDIA
Tel: 040-64596979,20020773, Fax: 040-24455003
E-mail: principal.mahaveer@gmail.com,
Website: www.mist.ac.in,

MAHAVEER
INSTITUTE OF SCIENCE & TECHNOLOGY
Approved by AICTE, Affiliated to JNTUH,Hyd.



Date: 10.03.2017

CIRCULAR

Technical Training for II B. Tech students are starting from 10th March, 2017 onwards. All HODs and Placements coordinators have to manage the trainings and ensure 95% attendance all through the sessions.

All Mentors need to send the compiled feedback report to, HOD at e3hod.civil@gmail.com daily.

Agenda: 1. Introduction to STAAD ProVi8.

DESIGNED BY

M. SAI KUMAR SAGAR

K. SAI PRADEEP

CH SWETHAMBER

HOD

K. Sagar
PRINCIPAL
MAHAVEER
INSTITUTE OF SCIENCE & TECHNOLOGY
Bandlaguda Post, Hyderabad-500 005.

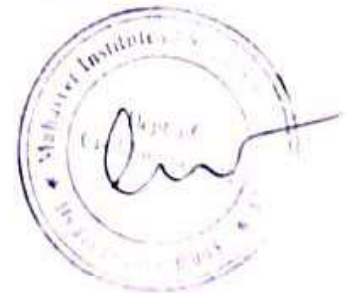



STAAD.ProVi8 SYLLABUS

Chapter 1: Before you start using Bentley STAAD.ProVi8

- h. Understanding Unit Conversion Tables
- i. Overview of Structural Design & Analysis
- j. Stresses and Stains
- k. Shear Force & Bending Moment Diagrams
- l. Introduction to Types of Structures
- m. Overview of Steel, Concrete and Foundation Design
- n. Introduction to Finite Element Analysis

Chapter 2: Introduction to STAAD.Pro

- l. About Bentley STAAD.Pro
- m. Starting STAAD.Pro
- n. Graphical User Interface
- o. Starting a New Project
- p. Working with User Interface:
 - Menu Bars
 - Tool Bars
 - Tabs
 - Snap Node / Beam Window
 - Data Area
 - Main Window
- q. Opening and Existing Project
- r. Saving a Project
- s. Configuring Units
- t. Keyboard Shortcuts
- u. Importing Model in STAAD.Pro
- v. Coordinate Systems

Chapter 3: Structural Modeling

- l. Adding Beams using Tools
- m. Creating Beams (Collinear, Along Axes)
- n. Creating Plates
- o. Creating Surfaces
- p. Creating Solid Elements
- q. Creating Structure
- r. Stretching and Intersecting Members
- s. Merging Members and Nodes
- t. Renumbering Nodes, Members and Elements
- u. Splitting and Breaking Beams
- v. Cutting Sections

Chapter 4: Material Constants and Section Properties

- f. Material Constants
- g. Creating and Editing Material Properties
- h. Assigning Materials to the Structure
- i. Orthotropic Materials
- j. Section Properties
 - Prismatic Sections
 - Tapered Sections

K. Mahaveer

PRINCIPAL
MAHAVEER
INSTITUTE OF SCIENCE & TECHNOLOGY
BANDLAGUDA, HYD-500005



- Steel Sections
- Steel Joist and JoistGirders
- Plate/SurfaceThickness

Chapter 5: Member Specifications and Supports

- e. NodeSpecification
- f. MemberSpecifications
 - Release
 - Offset
 - Property Reductionfactors
 - Cable
 - Truss
 - Compression
 - Tension
 - Inactive
- g. PlateSpecifications
 - Release
 - ignore InplaneRotation
 - PlaneStress
- h. Supports:
 - Fixed
 - Pinned
 - FixedBut
 - Enforced
 - EnforcedBut
 - MultilinearSpring
 - Foundation
 - Inclined
 - Tension/Compression OnlySprings

Chapter 6: Loads

- d. Types of Loads: Selfweight, Nodal, Member, Area, Floor, Plate, Surface andSolid,
- e. LoadGeneration
- f. LoadCombinations

Chapter 7: Performing Analysis

- c. PreAnalysis
 - ProblemStatistics
 - JointCoordinates
 - MemberInformation
 - MaterialProperties
 - SupportInformation
 - Element & SolidInformation
- d. PerformingAnalysis

Chapter 8: Post Processing & Report Creation

- e. Post AnalysisPrint
 - Loadlists
 - JointDisplacement
 - MemberForces
 - SupportReactions
 - CG
 - ModeShapes
 - SectionDisplacement
 - Analysis Results
 - MemberStresses
 - ElementForces/Stresses
- f. ViewingResults



PRINCIPAL
MAHAVEER
 INSTITUTION OF SCIENCE & TECHNOLOGY
 Gandhinagar, Hyderabad-500075

- g. OutputFile
- h. Post ProcessingMode

Chapter 9: Analysis Case Studies / Workshops

- e. RCCDesign&Analysis(BeamsandColumns)
- f. SteelDesign&Analysis(FramesandTrusses)
- g. MiscellaneousAnalysis
- h. Practice examples forStudents

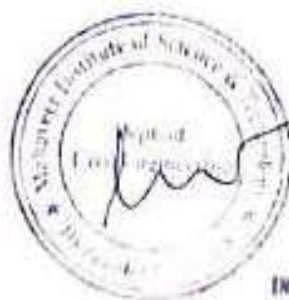

Manaveer

PRINCIPAL
MANAVEER
INSTITUTE OF SCIENCE & TECHNOLOGY
Bardhaman, West-Bengal, INDIA

Vysapuri, Bandlaguda Post: Keshavgi, Hyderabad-500 005, Telangana INDIA
 Tel: 040-64596979, 20020773, Fax: 040-24455003
 E-mail: principal.mahaveer@gmail.com
 Website: www.mist.ac.in

MAHAVEER

INSTITUTE OF SCIENCE & TECHNOLOGY
 Approved by AICTE, Affiliated to JNTUH, Hyd.



**Department of Mechanical Engineering
 STAAD PROVi8 Technical Training student attendance list
 2017-18**

SL.NO.	ROLL NO.	NAME OF THE STUDENT	YEAR
1	14E31A0101	A SRIKANTH	IV
2	14E31A0103	AMBATI NEELIMA	IV
3	14E31A0104	ANKITH KUMAR TIWARI	IV
4	14E31A0105	AREF ABUR RAHMAN AL KASERI	IV
5	14E31A0106	AVULA AJAYA LAKSHMI	IV
6	14E31A0107	BATHARAJU ARUN KUMAR	IV
7	14E31A0108	BATTHINI VINAY	IV
8	14E31A0109	BEJJURI PRASHANTH	IV
9	14E31A0111	BOINPELLI SHRUTHI	IV
10	14E31A0112	BUDUGULA KIRAN KUMAR	IV
11	14E31A0113	CHITIKESHI OMPRAKASH	IV
12	14E31A0114	EPPA OMPRAKASH	IV
13	14E31A0115	FAIZAN BAIG	IV
14	14E31A0116	GADDAVARI SHIVA KRISHNA	IV
15	14E31A0117	GANDLA SUHRUDH	IV
16	14E31A0118	GORLA SHRAVANI	IV
17	14E31A0119	GOTTE TEJASWEI	IV
18	14E31A0120	ISLAVATH PAVANKUMAR	IV
19	14E31A0121	JADHAV SAI KRISHNA	IV
20	14E31A0122	KONUGANTI NIKHIL REDDY	IV
21	14E31A0123	MAJJARI CHANDRA SHEKHAR	IV
22	14E31A0124	MASARATH JAHAN	IV
23	14E31A0125	MEKAPOTHULA SANDEEP	IV
24	14E31A0126	MIR SIDDIQ MUQTADIR ALI HASHMI	IV
25	14E31A0127	MOGILI LIKHITHA	IV
26	14E31A0128	MOGULAM ROHITH	IV
27	14E31A0129	MOHAMMED AIRAJ MOHIUDDIN	IV
28	14E31A0130	MOHAMMED ASIM SULEMAN	IV
29	14E31A0131	MOHAMMED JAWAD UDDIN	IV
30	14E31A0134	MOHD ABDUL RAOOF	IV
31	14E31A0136	MOHD IBRAHIMA FARUQUE	IV



**PRINCIPAL
 MAHAVEER
 INSTITUTE OF SCIENCE & TECHNOLOGY
 Bandlaguda, Hyderabad-500 005**

32	14E31A0137	MOHD MOHIUDDIN FAIZ	IV
33	14E31A0139	NAARSING AISHWARYA	IV
34	14E31A0140	NIMMALA THIRUPATHI	IV
35	14E31A0141	PALAM SRIKANTH REDDY	IV
36	14E31A0142	PERAPOGU SHASHI KIRAN	IV
37	14E31A0144	RAVINOTHALA NARENDRA BABU	IV
38	14E31A0145	SAYYAD SOHEL	IV
39	14E31A0147	SHAIK RAHIL FARAZ	IV
40	14E31A0148	SILUVERI MADHUKAR	IV
41	14E31A0149	SOMA SRILATHA	IV
42	14E31A0150	SYED ISMAIL	IV
43	14E31A0151	SYED KALEEM ULLAH QUADRI	IV
44	14E31A0152	SYED MOHAMMED FIRDOUSE	IV
45	14E31A0153	SYED MUSTAFA ALI	IV
46	14E31A0154	SYED NUMAN	IV
47	14E31A0155	SYED SAAD SHAREEF	IV
48	14E31A0157	VAISHNAVI UPADHYAY	IV
49	14E31A0158	VANAPARTHI SANTHOSH VARMA	IV
50	14E31A0159	VEMULA AVINASH	IV
51	15E35A0101	ALTAF AHMED	IV
52	15E35A0102	B SAI KRISHNA	IV
53	15E35A0103	BORRA RAGHU RAM	IV
54	15E35A0104	GANGULA RATHNA KUMAR	IV
55	15E35A0105	KASTHOORI VENKATAKRISHNA	IV
56	15E35A0106	MD JUNED	IV
57	15E35A0107	METHUKU SAGAR REDDY	IV
58	15E35A0108	MOHAMMED NADEEMUDDIN	IV
59	15E35A0109	NALLA SHESHU VARDHAN REDDY	IV
60	15E35A0110	NALLAPU VEERA HANUMANATHA RAO	IV
61	15E35A0112	V KAVITHA	IV
62	13E31A0102	ABDUL RAHMAN BIN HASSAN AL YAFAI	IV
63	13E31A0105	AMBALA RAJKUMAR	IV
64	13E31A0138	MUSKU SANTOSH	IV
65	13E31A0113	DABBA ROHITH	IV

K. S. V.

PRINCIPAL
MAHAVEER
 INSTITUTE OF SCIENCE & TECHNOLOGY
 mandlagadda, Hyderabad-500 005.



**MAHAVEER INSTITUTE OF SCIENCE & TECHNOLOGY, HYDERABAD
CIVIL ENGINEERING STUDENTS ATTENDANCE**

		B.TECH IV YEAR II SEM 2017-2018 BATCH (Date - 10/03/2017 - 21/03/2017)										
S.No	No	Name of the Candidate	1	2	3	4	5	6	7	8	9	10
1	14E31A0101	A SRIKANTH	A	P	P	P	P	P	P	P	P	P
2	14E31A0103	AMBATHINEELIMA	P	P	P	P	P	P	P	P	P	P
3	14E31A0104	ANKITH KUMAR TIWARI	P	P	P	P	P	P	P	P	P	P
4	14E31A0105	ARIF ABDUR RAHMAN AL KASERI	P	P	P	P	P	P	A	A	P	P
5	14E31A0106	AVULA AJAYA LAKSHMI	P	P	P	P	P	P	P	P	P	P
6	14E31A0107	BATHARAJU ARUN KUMAR	A	P	P	P	P	P	P	P	P	P
7	14E31A0108	BATTHINI VINAY	P	P	P	P	P	P	P	P	P	P
8	14E31A0109	BEJURIPRASHANTH	P	P	P	P	P	P	P	P	P	P
9	14E31A0111	BOJINPELLI SHIRUTHI	P	P	P	P	P	P	P	P	P	P
10	14E31A0112	BUDUGULA KIRAN KUMAR	P	P	P	P	P	P	P	P	P	P
11	14E31A0113	CHITKESHI OMIPRAKASH	P	P	P	P	P	P	P	P	P	P
12	14E31A0114	EPPA OMIPRAKASH	P	P	P	P	P	P	P	P	P	P
13	14E31A0115	FAIZAN BAIG	P	P	P	P	P	P	P	P	P	P
14	14E31A0116	GADDAVARI SHIVA KRISHNA	P	P	P	P	P	P	P	P	P	P
15	14E31A0117	GANDLA SUSRUDH	P	P	P	P	P	P	P	P	P	P
16	14E31A0118	GORLA SHRAVANI	P	P	P	P	P	P	P	P	P	P
17	14E31A0119	GOTTE TEJASWEI	P	P	P	P	P	P	P	P	P	P
18	14E31A0120	ISLAVATH PAVANKUMAR	P	P	P	P	P	P	P	P	P	P
19	14E31A0121	JADHAV SAJ KRISHNA	A	P	P	P	P	P	P	P	P	P
20	14E31A0122	KONIGANTENIKHIL REDDY	P	P	P	P	P	P	P	P	P	P
21	14E31A0123	MAJARI CHANDRA SHEKHAR	P	P	P	P	P	P	P	P	P	P
22	14E31A0124	MASARATH JAHAN	P	P	P	P	P	P	P	P	P	P
23	14E31A0125	MEKAPOTHULA SANDEEP	P	P	P	P	P	P	P	P	P	P
24	14E31A0126	MIR SIDDIQ MUQTADIR ALI HASHIMI	P	P	P	P	P	P	P	P	P	P
25	14E31A0127	MOGILLI LIKHITHA	A	P	P	P	P	P	P	P	P	P

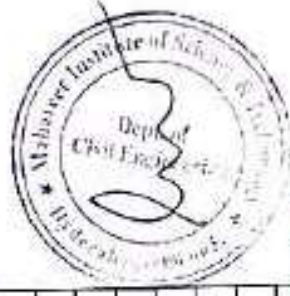

Handwritten signature

PRINCIPAL
M.A.H.AVEER
 INSTITUTE OF SCIENCE & TECHNOLOGY
 Rangaiguda, Hyd-500 005.



Sulby

PRINCIPAL

MAHAVEER

INSTITUTE OF SCIENCE & TECHNOLOGY
Bandlaguda, Hyd-500 005.

26	14E31A0128	MOGULAM ROHITH	P	P	P	A	P	P	A	P	P	P	P
27	14E31A0129	MOHAMMED AIRAJ MOHIUDDIN	P	P	P	P	P	P	P	P	P	P	P
28	14E31A0130	MOHAMMED ASIM SULEMAN	P	P	A	P	P	P	A	P	P	P	P
29	14E31A0131	MOHAMMED JAWAD UDDIN	P	P	P	P	P	P	P	A	P	P	P
30	14E31A0134	MOHD ABDUL RAOOF	P	P	P	P	P	A	P	P	P	P	P
31	14E31A0136	MOHD IBRAHIMA FARUQUE	P	P	A	P	P	P	P	A	P	P	P
32	14E31A0137	MOHD MOHIUDDIN FAIZ	P	P	P	P	P	P	P	P	P	P	P
33	14E31A0139	NAARSING AISHWARYA	P	P	P	A	P	P	A	P	P	P	P
34	14E31A0140	NIMMALA THIRUPATHI	P	P	P	P	P	P	P	P	P	P	P
35	14E31A0141	PALAM SRIKANTH REDDY	P	P	A	P	P	P	A	P	P	P	P
36	14E31A0142	PERAPOGU SHASHI KIRAN	P	P	P	P	P	P	A	P	P	A	P
37	14E31A0144	RAVINOTHALA NARENDRA BABU	P	P	A	P	P	P	P	P	P	P	P
38	14E31A0145	SAYYAD SOHEL	P	P	P	P	P	P	A	P	P	P	P
39	14E31A0147	SHAIK RAHIL FARAZ	P	P	P	P	P	P	P	P	A	P	P
40	14E31A0148	SILUVERIMADHUKAR	A	P	P	P	P	P	P	P	P	P	P
41	14E31A0149	SOMA SRILATHA	P	P	P	P	P	A	P	P	P	P	P
42	14E31A0150	SYED ISMAIL	P	P	P	P	P	P	P	A	P	P	P
43	14E31A0151	SYED KALFEM ULLAH QUADRI	P	P	P	P	P	P	P	A	P	P	A
44	14E31A0152	SYED MOHAMMED FIRDOUSE	A	P	A	P	P	P	P	P	P	P	P
45	14E31A0153	SYED MUSTAFA ALI	P	P	P	P	P	P	P	P	P	P	P
46	14E31A0154	SYED NUMAN	P	P	A	P	P	A	P	P	P	P	P
47	14E31A0155	SYED SAAD SHAREEF	P	P	P	P	P	P	P	P	P	P	P
48	14E31A0157	VAINSHAVI UPADHYAY	P	A	P	A	P	P	P	P	P	P	P
49	14E31A0158	VANAPARTHI SANTHOSH VARMA	P	P	P	P	A	P	P	P	A	P	P
50	14E31A0159	VEMULA AVINASH	P	P	A	P	P	P	P	P	P	A	P
51	15E35A0101	ALTAF AHMED	P	A	P	P	A	P	P	P	P	P	P
52	15E35A0102	B SAIKRISHNA	P	A	P	P	A	P	P	P	P	P	P
53	15E35A0103	BORRA RAGHU RAM	P	P	P	P	P	A	P	P	A	P	P
54	15E35A0104	GANGULA RAJHINA KUMAR	P	A	P	P	P	P	P	P	P	P	A
55	15E35A0105	KASTHOORI VENKATAKRISHNA	P	P	P	P	P	P	P	P	P	P	P
			A	P	P	P	A	P	P	P	P	P	P



Technical Training Exam on STAAD ProV18 Software (A.Y-2016-17)

2x10=20 Marks

Answer All the Questions

- a. Analyse the given beam using Staad Pro Cross section of Beam 200mmx400mm Grade of Concrete M 25 Grade of Steel Fe 415. Plot SFD,BMD and deflected profile.

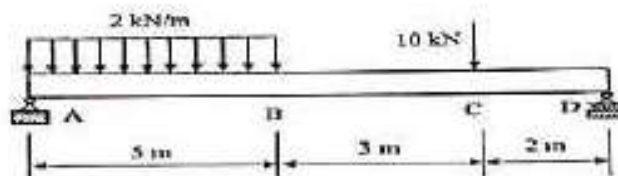

- b. Analyse the given beam using Staad Pro Cross section of Beam 200mmx400mm Grade of Concrete M 30 Grade of Steel Fe 415. Plot SFD,BMD and deflected profile.

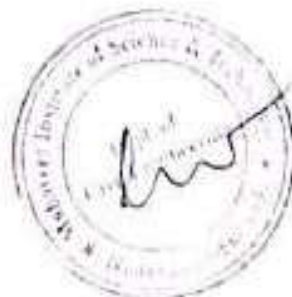
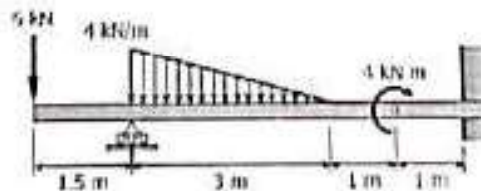

K. Subh
PRINCIPAL
MAHAVEER
INSTITUTE OF SCIENCE & TECHNOLOGY
Vysapuri, Bandlaguda Post, Keshavnagar,
Hyderabad-500 005.

- c. Analyse the given beam using Staad Pro Cross section of Beam 200mmx400mm Grade of Concrete M 25-Grade of Steel Fe 415. Plot SFD,BMD and deflected profile.

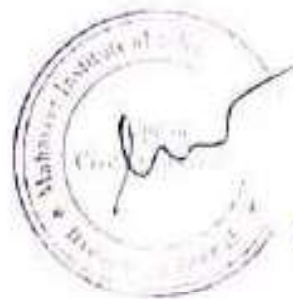
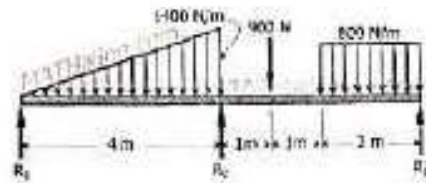

Abhishek
PRINCIPAL
MANAGER
Institute of Science & Technology
Campus: Gandhinagar, Sec-14, GGS, Indraprastha



Department of Mechanical Engineering
STAAD PROVi8 Technical Training student Marks list 2017-18

Sl.NO	Roll No	Name of the student	YEAR	MARKS	PASS/I
1	14E31A0101	A SRIKANTH	IV	15	PAS:
2	14E31A0103	AMBATI NEELIMA	IV	15	PAS:
3	14E31A0104	ANKITH KUMAR TIWARI	IV	16	PAS:
4	14E31A0105	AREF ABDUR RAHMAN AL KASERI	IV	15	PAS:
5	14E31A0106	AVULA AJAYA LAKSHMI	IV	15	PAS:
6	14E31A0107	BATHARAJU ARUN KUMAR	IV	15	PAS:
7	14E31A0108	BATTHINI VINAY	IV	15	PAS:
8	14E31A0109	BEJJURI PRASHANTH	IV	16	PAS:
9	14E31A0111	BOINIPELLI SHRUTHI	IV	15	PAS:
10	14E31A0112	BUDUGULA KIRAN KUMAR	IV	14	PAS:
11	14E31A0113	CHITIKESHI OMPRAKASH	IV	18	PAS:
12	14E31A0114	EPPA OMPRAKASH	IV	15	PAS:
13	14E31A0115	FAIZAN BAIG	IV	16	PAS:
14	14E31A0116	GADDAVARI SHIVA KRISHNA	IV	16	PAS:
15	14E31A0117	GANDLA SUHRUDH	IV	15	PAS:
16	14E31A0118	GORLA SHRAVANI	IV	16	PAS:
17	14E31A0119	GOTTE TEJASWEI	IV	16	PAS:
18	14E31A0120	ISLAVATH PAVANKUMAR	IV	16	PAS:
19	14E31A0121	JADHAV SAI KRISHNA	IV	16	PAS:
20	14E31A0122	KONUGANTI NIKHIL REDDY	IV	16	PAS:
21	14E31A0123	MAJJARI CHANDRA SHEKHAR	IV	16	PAS:
22	14E31A0124	MASARATH JAHAN	IV	15	PAS:
23	14E31A0125	MEKAPOTHULA SANDEEP	IV	15	PAS:
24	14E31A0126	MIR SIDDIQ MUQTADIR ALI HASHMI	IV	15	PAS:

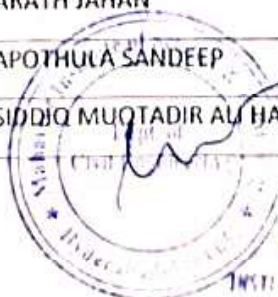

PRINCIPAL
MAHAVEER

INSTITUTE OF SCIENCE & TECHNOLOGY

Hyderabad, Telangana, India

25	14E31A0127	MOGILI LIKHITHA	IV	15	PASS
26	14E31A0128	MOGULAM ROHITH	IV	15	PASS
27	14E31A0129	MOHAMMED AIRAJ MOHIUDDIN	IV	15	PASS
28	14E31A0130	MOHAMMED ASIM SULEMAN	IV	15	PASS
29	14E31A0131	MOHAMMED JAWAD UDDIN	IV	16	PASS
30	14E31A0134	MOHD ABDUL RAOOF	IV	15	PASS
31	14E31A0136	MOHD IBRAHIMA FARUQE	IV	14	PASS
32	14E31A0137	MOHD MOHIUDDIN FAIZ	IV	18	PASS
33	14E31A0139	NAARSING AISHWARYA	IV	15	PASS
34	14E31A0140	NIMMALA THIRUPATHI	IV	16	PASS
35	14E31A0141	PALAM SRIKANTH REDDY	IV	16	PASS
36	14E31A0142	PERAPOGU SHASHI KIRAN	IV	15	PASS
37	14E31A0144	RAVINTHALA NARENDRA BABU	IV	16	PASS
38	14E31A0145	SAYYAD SOHEL	IV	15	PASS
39	14E31A0147	SHAIK RAHIL FARAZ	IV	14	PASS
40	14E31A0148	SILUVERI MADHUKAR	IV	18	PASS
41	14E31A0149	SOMA SRILATHA	IV	15	PASS
42	14E31A0150	SYED ISMAIL	IV	16	PASS
43	14E31A0151	SYED KALEEM ULLAH QUADRI	IV	16	PASS
44	14E31A0152	SYED MOHAMMED FIRDOUSE	IV	15	PASS
45	14E31A0153	SYED MUSTAFA ALI	IV	16	PASS
46	14E31A0154	SYED NUMAN	IV	14	PASS
47	14E31A0155	SYED SAAD SHAREEF	IV	18	PASS
48	14E31A0157	VAISHNAVI UPADHYAY	IV	15	PASS
49	14E31A0158	VANAPARTHI SANTHOSH VARMA	IV	16	PASS
50	14E31A0159	VEMULA AVINASH	IV	15	PASS

K. S. S.
PRINCIPAL
MAHAVEER
 INSTITUTE OF SCIENCE & TECHNOLOGY
 Mandragada, HAT-509 005.

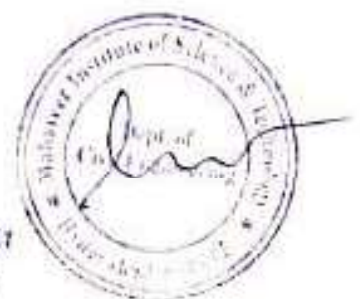

51	13E31A0102	ABDUL RAHMAN BIN HASSAN AL YAFAI	IV	15	PASS
52	15E35A0101	ALTAF AHMED	IV	16	PASS
53	15E35A0102	B SAI KRISHNA	IV	15	PASS
54	15E35A0103	BORRA RAGHU RAM	IV	14	PASS
55	15E35A0104	GANGULA RATHNA KUMAR	IV	18	PASS
56	15E35A0105	KASTHOORI VENKATAKRISHNA	IV	15	PASS
57	15E35A0106	MD JUNED	IV	16	PASS
58	15E35A0107	METHUKU SAGAR REDDY	IV	16	PASS
59	15E35A0108	MOHAMMED NADEEMUDDIN	IV	15	PASS
60	15E35A0109	NALLA SHESHU VARDHAN REDDY	IV	16	PASS
61	15E35A0110	NALLAPU VEERA HANUMANTHA RAO	IV	15	PASS
62	15E35A0112	V KAVITHA	IV	16	PASS
63	13E31A0105	AMBALA RAJKUMAR	IV	15	PASS
64	13E31A0138	MUSKU SANTOSH	IV	14	PASS
65	13E31A0113	DABBA ROHITH	IV	18	PASS

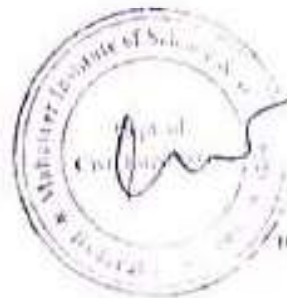

K. S. S.
PRINCIPAL
MAHAVEER

Vysapuri, Bandlaguda Post:Keshavgiri,
Hyderabad-500 005, Telangana INDIA
Tel: 040-64596979,20020773, Fax: 040-24455003
E-mail: principal.mahaveer@gmail.com,
Website: www.mist.ac.in,

MAHAVEER

Approved by AICTE, Affiliated to JNTUH,Hyd.



STAAD PROVi8 COURSE

Summery

Department of Civil Engineering

- Model Generation and Editing
- Assigning loads
- Creating Load Combinations
- Concrete Design
- Seismology
- Steel Design
- Foundation Designs
- Report Generation and Plotting

Handwritten signature in green ink

PRINCIPAL
MAHAVEER
INSTITUTE OF SCIENCE & TECHNOLOGY
HYD.

Vysapuri, Bandlaguda Post:Keshavgiri,
Hyderabad-500 005, Telangana INDIA
Tel: 040-64596979,20020773, Fax: 040-24455003
E-mail: principal.mahaveer@gmail.com,
Website: www.mist.ac.in,

MAHAVEER
INSTITUTE OF SCIENCE & TECHNOLOGY
Approved by AICTE, Affiliated to JNTUH,Hyd.



CERTIFICATE OF COURSE COMPLETION

This certificate is presented to _____ of
MIST,who has successfully completed technical training course
on “STAAD PROVi8” held from _____ to _____
and found the student performance to be excellent.



CH. SWETHAMBER
HOD
Civil department

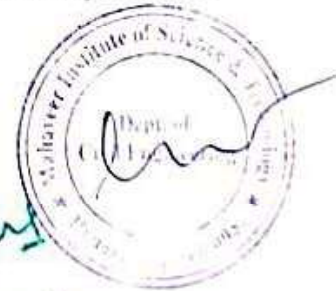

PRINCIPAL
MAHAVEER
INSTITUTE OF SCIENCE & TECHNOLOGY
Bandlaguda, Hyd-500 005.

Vysakhri, Bandlaguda Post, Keshavnagar,

MAHAVEER



Hyderabad-500 005, TELANGANA INDIA

Tel: 040-84596979, 8978380692 Fax: 040-24455903

E-mail: y3hod_eee@gmail.com

Website: www.mist.ac.in

Approved by AICTE, Affiliated to JNTUH, Hyd.

DEPARTMENT OF ELECTRICAL & ELECTRONICS

Date: 2-02-2018

To
The Principal,
Mist,
Hyderabad.

Sub-Proposal for Add on course-Reg.

Respected sir,

We are going to conduct two weeks workshop on **INDUSTRIAL MANAGEMENT**. We require your approval to go head for further proceeding and hope to get an opportunity to serve you the best.

With thanks and regards

R.V.Amavuth
HOD-EEE

Wahid

PRINCIPAL
MAHAVEER
INSTITUTE OF SCIENCE & TECHNOLOGY
Bandlaguda, Hyd-500 005.

Professor & HOD
Dept. of Electrical & Electronics
Mahaveer Institute of Science & Technology
Vysakhri, Bandlaguda, Keshavnagar,
Hyderabad - 500 005.

Vysapuri, Bandlaguda Post, Keshavnagar,

MAHAVEER



Hyderabad-500 005, TELANGANA INDIA

Tel: 040-64596979, 8978380692 Fax: 040-24455003

E-mail: e3hod_eee@gmail.com

Website: www.mist.ac.in

Approved by AICTE. Affiliated to: JNTU-Hyd

DEPARTMENT OF ELECTRICAL & ELECTRONICS

Date: 02-02-2018

CIRCULAR

Technical Trainings for II B.Tech students are starting from 13-02-2018 onwards. All HODs and placements coordinators have to manage the trainings and ensure 95% attendance all through the sessions.

All mentors need to send the compiled feedback report to HOD at e3hod_eee@gmail.com daily. Mentors are advised to take care of PNR (Students not participating in training).

Agenda: Industrial Management

Design & Development of Curriculum for Add on Courses Faculty Names 1. Dr R.V. AMARNATH
2. P.V.V SATYANARAYANA

PRINCIPAL
MAHAVEER
INSTITUTE OF SCIENCE & TECHNOLOGY
Bandlaguda, Hyd-500 005.

R.V. Amarnath
HOD-EEE

Professor & Head
Dept. of Electrical & Electronics Engg.
Mahaveer Institute of Science & Technology
Vysapuri, Bandlaguda, Keshavnagar,
Hyderabad - 500 005.

Vysapuri, Bandlaguda Post, Keshavpur,

MAHAVEER



Hyderabad-500 005, TELANGANA INDIA

Tel: 040-64596979, 8978380692 Fax: 040-24455903

E-mail: e3hod.eee@gmail.com

Website: www.mist.ac.in

Approved by AICTE. Affiliated to JNTUH, Hyd.

DEPARTMENT OF ELECTRICAL & ELECTRONICS

SYLLABUS FOR Industrial Management

SNO	TOPIC COVERED	DURATION
1	Introduction	3
2	Basics of control systems	3
3	Importance of control system	3
4	Open loop and closed loop systems	3
5	Components of control system	3
6	Different input buttons	3
7	Electrical actuators and controller	3
8	Block diagram reduction techniques	3
9	Working of Potentiometer	3
10	Control procedure in Control system	3

R.V. Amrath
HOD-EEE

Professor & Head
Dept. of Electrical & Electronics
Mahaveer Institute of Science & Tech.
Vysapuri, Bandlaguda, Keshav,
Hyderabad - 500 005.

R.V. Amrath
PRINCIPAL
MAHAVEER
INSTITUTE OF SCIENCE & TECHNOLOGY
Bandlaguda, Hyd-500 005.

Vysapuri, Bandlaguda Post, Keshavgiri,

MAHAVEER



Hyderabad-500 005, TEL: ANGANA INDIA

Tel: 040-64596979, 8978380692, Fax: 040-24465003

E-mail: e3hod.eee@gmail.com,

Website: www.mist.ac.in,

Approved by-AICTE, Affiliated to JNTUH, Hyd

DEPARTMENT OF ELECTRICAL & ELECTRONICS

LIST OF REGISTERED STUDENTS FOR Industrial Management

SNO	HALL TICKET NO	NAME OF THE STUDENT
1	16E31A0201	ABDUL RAHEMAN
2	16E31A0202	AKKALADEVI RAMYASRI
3	16E31A0203	ARUKONDA MANIDEEP
4	16E31A0204	HANOTH PRAVEENKUMAR
5	16E31A0205	BEJAWADA SANDEEP
6	16E31A0206	BYRA NAGARANI
7	16E31A0207	DESHWAL VINEET
8	16E31A0208	EEGA PRACHYUTH
9	16E31A0209	GUDAPATI VEENA
10	16E31A0210	JADAV SATHISH
11	16E31A0211	JYESTA RAJESWARI
12	16E31A0212	K.VEERESH
13	16E31A0213	KARLA GNANAPRASUNA
14	16E31A0214	MANDADI SOUNDARYA
15	16E31A0215	MANNE SRIDHAR
16	16E31A0216	MAVILLA RAGHAVENDER GOUD
17	16E31A0217	MD DANISH PERWEZ
18	16E31A0218	MEGAVATH PAVAN KUMAR
19	16E31A0219	MITTAPELLY MAHESH
20	16E31A0221	MS MANSHI DUBEY
21	16E31A0222	MUTHINENI VAMSHI
22	16E31A0223	PINREDDY AJITH REDDY
23	16E31A0224	PITTALA PAVAN KALYAN
24	16E31A0225	PUNNA VAISHNAVI
25	16E31A0226	RANJESHU VEER
26	16E31A0227	RENDLA RANJITH
27	16E31A0228	ROSHAN PATNAIK
28	16E31A0229	SANABOINA KRISHNAVAMS
29	16E31A0230	SHIRAM SHEETLY SAIKUMAR
30	16E31A0231	UPPUNUTALA ARUN KUMAR

Kishu
PRINCIPAL
MAHAVEER
INSTITUTE OF SCIENCE & TECHNOLOGY
Bandlaguda, Hyd-500 005.

R. Varma
Professor & Head
Dept. of Electrical & Electronics Engg
Mahaveer Institute of Science & Technology
Vysapuri, Bandlaguda, Keshavgiri,
Hyderabad - 500 005.

Vysaviotti, Bandlaguda Post, Keshavnagar,

MAHAVEER



Hyderabad-500 005, TELANGANA, INDIA

Tel: 040-64596979, 8979380692 Fax: 040-24455003

E-mail: e3hod.yes@gmail.com

Website: www.mist.ac.in

Approved by AICTE, Affiliated to JNTU(Hydr)

DEPARTMENT OF ELECTRICAL & ELECTRONICS

RESULT SHEET FOR Industrial Management REGISTERED STUDENTS

SNO	HALL TICKET NO	NAME OF THE STUDENT	MARKS (20)	RESULT
1	16E31A0201	ABDEL RAHEMAN	20	PASS
2	16E31A0202	AKKALADEVI RAMYASRI	19	PASS
3	16E31A0203	ARJUNDA MANDHEP	20	PASS
4	16E31A0204	BANOTH PRAVEENKUMAR	18	PASS
5	16E31A0205	BEJAWADA SANDEEP	20	PASS
6	16E31A0206	BYRA NAGARANI	20	PASS
7	16E31A0207	DISHWAL VINEET	16	PASS
8	16E31A0208	EEGA PRACHYUTH	20	PASS
9	16E31A0209	GUDAPATI VEENA	20	PASS
10	16E31A0210	JADAV SATHISH	17	PASS
11	16E31A0211	JYESTA RAJESWARI	20	PASS
12	16E31A0212	K VEERESH	20	PASS
13	16E31A0213	KARLA GNANAPRASUNA	16	PASS
14	16E31A0214	MANDADI SOUNDARYA	20	PASS
15	16E31A0215	MANNE SRIDHAR	20	PASS
16	16E31A0216	MAVILLA RAGHAVENDER GOUD	18	PASS
17	16E31A0217	MD DANISH PERWEZ	20	PASS
18	16E31A0218	MEGAVATH PAVAN KUMAR	19	PASS
19	16E31A0219	MITTAPELLY MAHESH	20	PASS
20	16E31A0221	MS MANSHI DUBEY	18	PASS
21	16E31A0222	CHITRAVAI ANSHU	20	PASS
22	16E31A0223	PUSREDDY SATHI KIRAN	20	PASS
23	16E31A0224	PILLALA PAVAN KALYAN	16	PASS
24	16E31A0225	PUNNA VAISHNAVI	20	PASS
25	16E31A0226	RAJARAJU VIJAY	19	PASS
26	16E31A0227	RENDELA RANJITH	20	PASS
27	16E31A0228	ROSHAN PATNAIK	18	PASS
28	16E31A0229	SANABOINA KRISHNAVAMSI	20	PASS
29	16E31A0230	SHIRAM SHETTY SAI KUMAR	20	PASS
30	16E31A0231	UPPUNUTALA ARUN KUMAR	16	PASS

Kalyan MUNICIPAL
MAHAVEER
INSTITUTE OF SCIENCE & TECHNOLOGY
Bandlaguda, Hyd-500 005.

Vysapur, Bandlaguda Post, Keshavnagar,

MAHAVEER



Hyderabad-500 005, TELANGANA INDIA

Tel: 040-64596979, 8978380692 Fax: 040-24455003

E-mail: e3hod.eee@gmail.com

Website: www.mist.ac.in

Approved by AICTE. Affiliated to JNTUHH, Hyd.

DEPARTMENT OF ELECTRICAL & ELECTRONICS

No. of students Registered: 30

No. of students Passed: 30

No. of students failed: NIL

R. V. Amritha

PROFESSOR & HEAD

Dept. of Electrical & Electronics Engg
Mahaveer Institute of Science & Technology
Vysapur, Bandlaguda, Keshavnagar,
Hyderabad - 500 005.

K. S. S. S.

PRINCIPAL
MAHAVEER
INSTITUTE OF SCIENCE & TECHNOLOGY
Bandlaguda, Hyd-500 005.

Vysapuri, Bandlaguda Post, Keshavnagar,

MAHAVEER



Hyderabad-500 005, TELANGANA INDIA

Tel: 040-64596979, 8978380692 Fax: 040-24455903

E-mail: e3hod.eee@gmail.com

Website: www.misl.ac.in

Approved by AICTE, Affiliated to JNTU(H)Hyd.

DEPARTMENT OF ELECTRICAL & ELECTRONICS

Industrial Management QUESTION PAPER

Duration: 120 Minutes

4 X 5 = 20 Marks

Answer the following all questions. Each question carries 5 marks.

1. What is the main objective of Industrial Management?
2. What are the Responsibility of a Production Manager?
3. Explain shutdown maintenance and predictive maintenance?
4. Explain preventive maintenance and corrective maintenance ?

K. Srinivas

PRINCIPAL
MAHAVEER
INSTITUTE OF SCIENCE & TECHNOLOGY
Bandlaguda, Hyd-500 005.

R. V. Anasethi
HOD-EEE

Professor & Head
Dept. of Electrical & Electronics Engg
Mahaveer Institute of Science & Technology
Vysapuri, Bandlaguda, Keshavnagar,
Hyderabad - 500 005.

Vysapuri, Bandlaguda Post:Keshavgiri,

MAHAVEER



Hyderabad-500 005, TELANGANA INDIA

Tel: 040-64596979,8978380692, Fax: 040-24455003

E-mail: e3hod.eee@gmail.com,

Website: www.mist.ac.in,

Approved by AICTE, Affiliated to JNTU(Hydr)

DEPARTMENT OF ELECTRICAL & ELECTRONICS

SUMMARY REPORT OF Industrial Management

Industrial management is the organizational process that includes **strategic planning, setting objectives, managing resources, deploying the human and financial assets needed to achieve objectives, and measuring results.**

COOR
FOR

Copy to:

1. Department Notice Board
2. Principal for Information
3. Committee Members (Academic)

Kshy

PRINCIPAL
MAHAVEER
INSTITUTE OF SCIENCE & TECHNOLOGY
Bandlaguda, Hyd-500 005.

	1	2	3	4	5	6	7	8	9	10	11	12	13	14	15	16	17	18	19	20	21	22	23	24	25	26	27	28	29	30
1	16E31A0201	ABDEL RAHEMAN	P	P	P	P	P	P	P	P	P	P	P	P	P	P	P	P	P	P	P	P	P	P	P	P	P	P	P	P
2	16E31A0202	AKKALADEVI RAMYANRI	P	P	P	P	P	P	P	P	P	P	P	P	P	P	P	P	P	P	P	P	P	P	P	P	P	P	P	P
3	16E31A0204	BANOTH PRAVEENKUMAR	P	P	P	P	P	P	P	P	P	P	P	P	P	P	P	P	P	P	P	P	P	P	P	P	P	P	P	P
4	16E31A0206	BYRA NAGARANI	P	P	P	P	P	P	P	P	P	P	P	P	P	P	P	P	P	P	P	P	P	P	P	P	P	P	P	P
5	16E31A0207	DESHWAL VINEET	P	P	P	P	P	P	P	P	P	P	P	P	P	P	P	P	P	P	P	P	P	P	P	P	P	P	P	P
6	16E31A0208	EEGA PRACHYUTHI	P	P	P	P	P	P	P	P	P	P	P	P	P	P	P	P	P	P	P	P	P	P	P	P	P	P	P	P
7	16E31A0209	GUDAPATI VEENA	P	P	P	P	P	P	P	P	P	P	P	P	P	P	P	P	P	P	P	P	P	P	P	P	P	P	P	P
8	16E31A0210	JADAV SATHISH	P	P	P	P	P	P	P	P	P	P	P	P	P	P	P	P	P	P	P	P	P	P	P	P	P	P	P	P
9	16E31A0211	JYESTHA RAJESWARI	P	P	P	P	P	P	P	P	P	P	P	P	P	P	P	P	P	P	P	P	P	P	P	P	P	P	P	P
10	16E31A0212	K V PRESH	P	P	P	P	P	P	P	P	P	P	P	P	P	P	P	P	P	P	P	P	P	P	P	P	P	P	P	P
11	16E31A0213	KARTI GGNANAPRASANA	P	P	P	P	P	P	P	P	P	P	P	P	P	P	P	P	P	P	P	P	P	P	P	P	P	P	P	P
12	16E31A0214	MANDADI SOUNIDARVA	P	P	P	P	P	P	P	P	P	P	P	P	P	P	P	P	P	P	P	P	P	P	P	P	P	P	P	P
13	16E31A0218	MEGAVATH PAVAN KUMAR	P	P	P	P	P	P	P	P	P	P	P	P	P	P	P	P	P	P	P	P	P	P	P	P	P	P	P	P
14	16E31A0221	MIS MANSHI DUBEY	P	P	P	P	P	P	P	P	P	P	P	P	P	P	P	P	P	P	P	P	P	P	P	P	P	P	P	P
15	16E31A0223	PINREDDY AJITHI REDDY	P	P	P	P	P	P	P	P	P	P	P	P	P	P	P	P	P	P	P	P	P	P	P	P	P	P	P	P
16	16E31A0224	PITTALA PAVAN KAIYAN	P	P	P	P	P	P	P	P	P	P	P	P	P	P	P	P	P	P	P	P	P	P	P	P	P	P	P	P
17	16E31A0225	PUNNA VAISHNAVI	P	P	P	P	P	P	P	P	P	P	P	P	P	P	P	P	P	P	P	P	P	P	P	P	P	P	P	P
18	16E31A0226	RAJARAPU VIDAY	P	P	P	P	P	P	P	P	P	P	P	P	P	P	P	P	P	P	P	P	P	P	P	P	P	P	P	P
19	16E31A0227	RENDELA RANJITH	P	P	P	P	P	P	P	P	P	P	P	P	P	P	P	P	P	P	P	P	P	P	P	P	P	P	P	P
20	16E31A0228	ROSHAN PATNAIK	P	P	P	P	P	P	P	P	P	P	P	P	P	P	P	P	P	P	P	P	P	P	P	P	P	P	P	P
21	16E31A0229	SANABONA KRISHNAVAMSI	P	P	P	P	P	P	P	P	P	P	P	P	P	P	P	P	P	P	P	P	P	P	P	P	P	P	P	P
22	17E35A0201	ARMUR AVINASH	P	P	P	P	P	P	P	P	P	P	P	P	P	P	P	P	P	P	P	P	P	P	P	P	P	P	P	P
23	17E35A0202	AVANIGANTI SATEESH	P	P	P	P	P	P	P	P	P	P	P	P	P	P	P	P	P	P	P	P	P	P	P	P	P	P	P	P
24	17E35A0203	BANDE APAVANI	P	P	P	P	P	P	P	P	P	P	P	P	P	P	P	P	P	P	P	P	P	P	P	P	P	P	P	P
25	17E35A0204	CHOPPARI ABHIJASHI	P	P	P	P	P	P	P	P	P	P	P	P	P	P	P	P	P	P	P	P	P	P	P	P	P	P	P	P
26	17E35A0205	DONGALA NARESH	P	P	P	P	P	P	P	P	P	P	P	P	P	P	P	P	P	P	P	P	P	P	P	P	P	P	P	P
27	17E35A0206	EGURI A MAJHU	P	P	P	P	P	P	P	P	P	P	P	P	P	P	P	P	P	P	P	P	P	P	P	P	P	P	P	P
28	17E35A0207	GADDASULA NARISHI	P	P	P	P	P	P	P	P	P	P	P	P	P	P	P	P	P	P	P	P	P	P	P	P	P	P	P	P
29	17E35A0208	KALLEPALLY KEEBHANS	P	P	P	P	P	P	P	P	P	P	P	P	P	P	P	P	P	P	P	P	P	P	P	P	P	P	P	P
30	17E35A0209	MUNISHETTI NIHARIKA	P	P	P	P	P	P	P	P	P	P	P	P	P	P	P	P	P	P	P	P	P	P	P	P	P	P	P	P
31	17E35A0210	NAMPALLY NIKHIL	P	P	P	P	P	P	P	P	P	P	P	P	P	P	P	P	P	P	P	P	P	P	P	P	P	P	P	P
32	17E35A0211	PATHIPAKA SAKHARAN	P	P	P	P	P	P	P	P	P	P	P	P	P	P	P	P	P	P	P	P	P	P	P	P	P	P	P	P
33	17E35A0212	YADAGHRI LALITHA KUMARI	P	P	P	P	P	P	P	P	P	P	P	P	P	P	P	P	P	P	P	P	P	P	P	P	P	P	P	P
34	16E35A0202	ERRALLA DEEPAK	P	P	P	P	P	P	P	P	P	P	P	P	P	P	P	P	P	P	P	P	P	P	P	P	P	P	P	P

Signature of the Faculty

Dr. Narayana Murthy
 Professor & Head
 Dept. of Industrial & Manufacturing Engineering
 Institute of Technology & Management
 Visagapatnam, Rayachoti, AP, India

2
17
100

RINCEP
S.S.S.

MAHAVEER INSTITUTE OF SCIENCE AND TECHNOLOGY

(Affiliated to JNTUH, Hyderabad and Approved by AICTE, New Delhi)
Vyasapuri, Bandlaguda, Post: Keshavagiri, Hyderabad- 500005



ESTD 2001

organized by

Department of Electrical and Electronics Engineering

CERTIFICATE

This is certify that Rajarapu Vijay bearing Hall Ticket No 16E31A02,
B.Tech Second Year has Participated in Industrial management Training
Program From 13-02-2018 to 26-02-2018 organized by Department
Electrical and Electronics Engineering.

R.V. Amarnath

HOD

Dr.R.V.Amarnath

Dr.M.Rajendar Reddy

Dr.M.Rajendar Reddy

VITS

Dr.K.S.S.S.N

PRINCIPAL

Dr.K.S.S.S.N

Five week certificate course

!!!

Industrial Management

(14th Feb-01st Mar 2018)
Timings: 10.30 am to 1.30 pm



Organized by



Dept. Of Electrical & Electronics Engineering
Mahaveer Institute of Science & Technology
Vyasapuri, Bandlaguda, Hyderabad 500005.
(Affiliated to JNTUHR)

About the College

As an institute committed to quality education, **MIST** aims at providing learning with a technology edge. Right from its inception in 2001, it has turned itself to meet this objective. It endeavours to provide consistent training to the students to help them evolve as competent professionals in the highly competitive world.

About the Department

The Department of **Electrical & Electronics Engineering** was established in 2001 which offers **B.Tech, and M.Tech (POWER Engineering and Energy Systems)** courses with highly qualified, dedicated and motivated faculty. The courses and programmes offered by the department not only impart technical expertise to the students but also gives a professional experience.

Organizing committee

Chief Patrons

Smt. S Sudershan Reddy, Chairman, MIST
Sri S. Surendar Reddy, Secretary, MIST

Patron

Dr. KSSSN Reddy, Principal, MIST

Convener

Dr. K.V. Anuramath, Professor, HoD EEE Dept

Co-convenor

Mr. G.Prem Kumar Reddy, Associate Prof. EEE

Program Co-ordinators

Mr. B. SATISH Assistant Professor, EEE
Mrs. N. SARASWATHI Assistant Professor, EEE
Mr. A. MAHESH Assistant Professor, EEE
Mr. T. Ravi Babu Assistant Professor, EEE
Mr. P. Phaniendra, Assistant Professor, EEE
Mr. G. Harinarum, Assistant Professor, EEE
Mr. B. Sravyasuba, Assistant Professor, EEE

Course Details

- Introduction
- Basics of control systems
- Importance of control system system.
- Open loop and closed loop systems
- Components of control system
- Electrical actuators and controller
- Control procedure in Control system

Resource Person

Dr. M. Rajendar Reddy, VITS

Objective of Workshop

Industrial management is the organizational process that includes strategic planning, setting objectives, managing resources, deploying the human and financial assets needed to achieve objectives, and measuring results.

Who can Participate

Students and Faculty members of various Universities, Colleges and Industries.

Contact details

Feel free to ask your queries either by E-Mail
(eeehod.see@gmail.com), (or) 8919959541
Contact – 8309846628, 8985906696.

Venue:

Main Seminar Hall

Mahaveer Institute of Science &
Technology
Vyasapuri, Bandlaguda, Pvr Keshavpur,
Hyderabad- 500005, Telangana, India

Vysapuri, Bandlaguda Post:Keshavgiri,

MAHAVEER



Hyderabad-500 005, TELANGANA INDIA

Tel: 040-64596979,8978380692, Fax: 040-24455003

E-mail: e3hod.eee@gmail.com,

Website: www.mist.ac.in,

INSTITUTE OF SCIENCE & TECHNOLOGY

Approved by AICTE, Affiliated to JNTUH,Hyd.

DEPARTMENT OF ELECTRICAL & ELECTRONICS

Date: 02-09-2017

To
The Principal,
Mist,
Hyderabad.

Sub:Proposal for Add on course-Reg.

Respected sir,

We are going to conduct two weeks workshop on **ELECTRICAL INSTALLATION STANDARDS**. We require your approval to go head for further proceeding and hope to get an opportunity to serve you the best.

With thanks and regards.

R.V:Amrath

HOD-EEE

Professor & Head

Dept. of Electrical & Electronics Engrg
Mahaveer Institute of Science & Technology
Vysapuri, Bandlaguda, Keshavgiri,
Hyderabad - 500 005.

Kishu
PRINCIPAL
MAHAVEER
INSTITUTE OF SCIENCE & TECHNOLOGY
Bandlaguda, Hyd-500 005,
Bandlaguda, Hyd-500 005.

Vysapuri, Bandlaguda Post:Keshavgiri,

MAHAVEER



Hyderabad-500 005, TELANGANA INDIA

Tel: 040-64596979,8978380692,Fax: 040-24455903

E-mail: e3hod.eee@gmail.com,

Website: www.mist.ac.in,

Approved by AICTE, Affiliated to JNTUH,Hyd.

DEPARTMENT OF ELECTRICAL & ELECTRONICS

Date: 02-09-2017

CIRCULAR

Technical Trainings for III B. Tech students are starting from 12-09-2017 onwards. All HODs and placements coordinators have to manage the trainings and ensure 95% attendance all through the sessions.

All mentors need to send the compiled feedback report to HOD at e3hod.eee@gmail.com daily. Mentors are advised to take care of PNR (Students not participating in training).

Agenda: **Electrical Installation Standards**

Design & Development of Curriculum for Add on Course Faculty Names 1. Dr Rv Amarnath

2. G Prem kumar reddy

K. Srinivas
PRINCIPAL
MAHAVEER
INSTITUTE OF SCIENCE & TECHNOLOGY
Bandlaguda, Hyd-500 005.

R.V. Amarnath
HOD-EEE
Professor & Head
Dept. of Electrical & Electronics Engg
Mahaveer Institute of Science & Technology
Vysapuri, Bandlaguda, Keshavgiri,
Hyderabad - 500 005.

Vysapuri, Bandlaguda Post:Keshavgiri,

MAHAVEER



Hyderabad-500 005, TELANGANA INDIA

Tel: 040-64596979,8978380692,Fax: 040-24455003

E-mail: e3hcdl.eee@gmail.com,

Website: www.mist.ac.in,

Approved by AICTE, Affiliated to JNTUH,Hyd.

DEPARTMENT OF ELECTRICAL & ELECTRONICS

SYLLABUS FOR Electrical Installation Standards

SNO	TOPIC COVERED	DURATION
1	<i>Introduction</i>	3
2	<i>Electric shock</i>	3
3	<i>Exposed metals</i>	3
4	<i>Fuses</i>	3
5	<i>Circuit breaker</i>	3
6	<i>Boiler</i>	3
7	<i>Turbine</i>	3
8	<i>Alternator</i>	3
9	<i>Pulvarization</i>	3
10	<i>Working of tps</i>	3

PRINCIPAL,
MAHAVEER
INSTITUTE OF SCIENCE & TECHNOLOGY
Bandlaguda, Hyd-500 005.

R.V. Amrath
HOD-EEE

Professor & Head
Dept. of Electrical & Electronics Engg
Mahaveer Institute of Science & Technology
Vysapuri, Bandlaguda, Keshavgiri,
Hyderabad - 500 005.

**DEPARTMENT OF ELECTRICAL & ELECTRONICS****LIST OF REGISTERED STUDENTS FOR Electrical Installation Standards**

SNO	HALL TICKET NO	NAME OF THE STUDENT
1	15E31A0201	ADARI UMASHANKAR
2	15E31A0203	ARRUM VAMSHIKRISHNA
3	15E31A0205	B AKHILA
4	15E31A0206	BALLE ARAVIND KUMAR
5	15E31A0207	BANOTH BALAJI
6	15E31A0208	BITUKYA PRAVALIKA
7	15E31A0209	BURRA HARISH
8	15E31A0210	CHEVITI VINAY KUMAR
9	15E31A0211	GANDI SAI KIRAN
10	15E31A0213	GUDA AVINASH
11	15E31A0216	KASIREDDY SAI KIRAN REDDY
12	15E31A0217	KATAKAM ANUDEEP KUMAR
13	15E31A0218	KAVYA N
14	15E31A0219	KOKKULA SAIKIRAN
15	15E31A0220	KOONARAPU AKHIL
16	15E31A0221	KUCHOOR PRANEETHDEEP REDDY
17	15E31A0222	KUSUNOJU MADHU
18	15E31A0224	NADDIPALLI KANCHANA
19	15E31A0225	NAKIDI ABHISHEK
20	15E31A0226	NERLAKANTI NANDUVARDHAN REDDY
21	15E31A0227	RATHOD AMBADAS
22	15E31A0228	SHIVANNAGARI BHASKARREDDY
23	15E31A0229	SHIVAMALLA SIVA SRI
24	15E31A0230	SGDENRIKRISHNA
25	15E31A0231	THONGALA SHINEY
26	15E31A0232	VOGULAPU RAJESH
27	15E31A0233	VARUKALA SAI PRAKASH
28	15E31A0234	J RAVI TEJA
29	16E35A0201	ALETI NISHITA
30	16E35A0202	ERRALLA DEEPAK
31	16E35A0203	JAKANAPALLY SHRISHA
32	16E35A0204	JALLA ANJANEYULU
33	16E35A0205	KRISHNATEJA ALETI
34	16E35A0206	PEDDA GOLLA SHRISHA YADAV
35	16E35A0207	PURI NARSING

PRINCIPAL
MAHAVEER
 INSTITUTE OF SCIENCE & TECHNOLOGY
 Bandlaguda, Hyd-500 005.

Vysapuri, Bandlaguda Post:Keshavgiri,

MAHAVEER



Hyderabad-500 005, TELANGANA INDIA

Tel: 040-64596979,8978380692, Fax: 040-24455003

E-mail: e3hod.eee@gmail.com,

Website: www.mist.ac.in,

Approved by AICTE, Affiliated to JNTU(Hydr.)

DEPARTMENT OF ELECTRICAL & ELECTRONICS

36	16E35A0208	RAVULA PAVAN KUMAR
37	16E35A0209	SURYA SRAVANTHI
38	16E35A0210	VANGALA RANEETH KUMAR
39	16E35A0211	YALAGANDULA DURGA DEVI

R.V. Amath

Professor & Head

Dept. of Electrical & Electronics Engg.
Mahaveer Institute of Science & Technology
Vysapuri, Bandlaguda, Keshavgiri
Hyderabad - 500 005.

K. Srinivas

PRINCIPAL
MAHAVEER
INSTITUTE OF SCIENCE & TECHNOLOGY
Bandlaguda, Hyd-500 005.

Vysapuri, Bandlaguda Post:Keshavgiri,

MAHAVEER



Hyderabad-500 005, TELANGANA INDIA

Tel: 040-64596979,8978380692, Fax: 040-24455003

E-mail: e3hod.eee@gmail.com,

Website: www.mist.ac.in,

Approved by AICTE, Affiliated to JNTUH.Hyd.

DEPARTMENT OF ELECTRICAL & ELECTRONICS

Electrical Installation Standards QUESTION PAPER

Duration: 120 Minutes

4 X 5 = 20 Marks

Answer the following all questions. Each question carries 5 marks.

- Q1.Explain electric shock?
- Q2.Explain all exposed metals in electrical circuit?
- Q3. Explain process electricity made in power plant?
- Q4. Explain difference between fuse and circuit breaker?

K. Srinivas

MAHAVEER
INSTITUTE OF SCIENCE & TECHNOLOGY
Bandlaguda, Hyd-500 005,

R.V. Amrath
HOD-EEE

Professor & Head
Dept. of Electrical & Electronic Engg
Mahaveer Institute of Science & Tech
Vysapuri, Bandlaguda, Keshavgiri,
Hyderabad - 500 005.

**DEPARTMENT OF ELECTRICAL & ELECTRONICS****RESULT SHEET FOR Electrical Installation Standards REGISTERED STUDENTS**

SNO	HALL TICKET NO	NAME OF THE STUDENT	MARKS (20)	RESULT
1	15E31A0201	ADARI UMASHANKAR	20	PASS
2	15E31A0203	ARRUM VAMSHIKRISHNA	19	PASS
3	15E31A0205	B AKHILA	20	PASS
4	15E31A0206	BALLE ARAVIND KUMAR	18	PASS
5	15E31A0207	BANOTH BALAJI	20	PASS
6	15E31A0208	BHUKYA PRAVALIKA	20	PASS
7	15E31A0209	BURRA HARISH	16	PASS
8	15E31A0210	CHEVITI VINAY KUMAR	20	PASS
9	15E31A0211	GANDI SAI KIRAN	20	PASS
10	15E31A0213	GUDA AVINASH	17	PASS
11	15E31A0216	KASIREDDY SAI KIRAN REDDY	20	PASS
12	15E31A0217	KATAKAM ANUDEEP KUMAR	20	PASS
13	15E31A0218	KAVYA N	16	PASS
14	15E31A0219	KOKKULA SAIKIRAN	20	PASS
15	15E31A0220	KOONARAPU AKHIL	20	PASS
16	15E31A0221	KUCHOOR PRANEETHDEEP REDDY	18	PASS
17	15E31A0222	KUSUNOJU MADHU	20	PASS
18	15E31A0224	NADDIPALLI KANCHANA	19	PASS
19	15E31A0225	NAKIDI ABHISHEK	20	PASS
20	15E31A0226	NERI KANALI NANDYA ARDHAN REDDY	18	PASS
21	15E31A0227	RATHOD AMBADAS	20	PASS
22	15E31A0228	SHIVANNAGARI BHASKARREDDY	19	PASS
23	15E31A0229	SILUSANI NAVYASRI	20	PASS
24	15E31A0230	SODI SRIKRISHNA	18	PASS
25	15E31A0231	THONGALA SHINEY	20	PASS
26	15E31A0232	VOGULAPU RAJESH	20	PASS
27	15E31A0233	YARUKALA SAI PRAKASHI	16	PASS
28	15E31A0234	J RAVI TEJA	20	PASS
29	16E35A0201	ALETI NISHITA	20	PASS
30	16E35A0202	ERRALLA DEEPAK	17	PASS

Vysapuri, Bandlaguda Post:Keshavgiri,

MAHAVEER



Hyderabad-500 005, TELANGANA INDIA

Tel: 040-64596979,8978380692,Fax: 040-24455003

E-mail: e3hod.eee@gmail.com,

Website: www.mist.ac.in,

Approved by AICTE, Affiliated to JNTUH,Hyd.

DEPARTMENT OF ELECTRICAL & ELECTRONICS

31	16E35A0203	JAKANAPALLY SHIRISHA	20	PASS
32	16E35A0204	JALLA ANJANEYULU	20	PASS
33	16E35A0205	KRISHNATEJA ALETI	16	PASS
34	16E35A0206	PEDDA GOLLA SHIRISHA YADAV	20	PASS
35	16E35A0207	PURI NARSING	20	PASS
36	16E35A0208	RAVULA PAVAN KUMAR	18	PASS
37	16E35A0209	SURYA SRAVANTHI	20	PASS
38	16E35A0210	VANGALA RANEETH KUMAR	19	PASS
39	16E35A0211	YALAGANDULA DURGA DEVI	20	PASS

No. of students Registered: 39

No. of students Passed: 39

No. of students failed: NIL

R.V. Aravind

Professor & Head

Dept. of Electrical & Electronics Engg
Mahaveer Institute of Science & Technology
Vysapuri, Bandlaguda, Keshavgiri,
Hyderabad - 500 005.

K. Srinivas

PRINCIPAL
MAHAVEER
INSTITUTE OF SCIENCE & TECHNOLOGY
Bandlaguda, Hyd-500 005.

Vysapuri, Bandlaguda Post:Keshavgi,

MAHAVEER



Hyderabad-500 005, TELANGANA INDIA

Tel: 040-64596979,8978380692 Fax: 040-24455003

E-mail: e3hod.eee@gmail.com,

Website: www.mist.ac.in,

Approved by AICTE, Affiliated to JNTUH,Hyd.

DEPARTMENT OF ELECTRICAL & ELECTRONICS

SUMMARY REPORT OF Electrical Installation Standards

The study of a proposed electrical installation requires an adequate understanding of all governing rules and regulations. A list of most common IEC standards is provided.

The total power demand can be calculated based on the location and power of each load, together with the knowledge of the operating modes (steady state demand, starting conditions, non simultaneous operation, etc.).

The power and number of sources required to supply the electrical installation is readily obtained, also taking into account local tariff structures, to allow the best choice of connection arrangement to the power-supply network, e.g. at medium voltage or low voltage level.

COORDINATOR

Copy to:

1. Department Notice Board
2. Principal for Information
3. Committee Members (Academic)



PRINCIPAL
MAHAVEER
INSTITUTE OF SCIENCE & TECHNOLOGY
Bandlaguda, Hyd-500 005.

*A Two week Certificate Course
On*

**“Electrical Installation standards”
(12th - 28th sep 2017)**

REGISTRATION FORM

Full Name:

Designation:

Organization:

Experience (in years):

Industry:..... Teaching:.....

Research:.....

Correspondence

Address:.....

.....

.....

E-mail id for communication (trust):

.....

Ptc:

Sign of Applicant:

Signature of
Head of the Institution with official Seal

Important Dates

Last date of Receiving Applications: 10.12.2017

Intimation to the selected participants: 11.12.2017

General Information:

- Tea, snacks and lunch will be served.
- Certificates will be issued to all the participants.
- Transportation will be provided from city to college.
- Limited accommodation will be provided on request from participants.

About the College:

An Institute committed to quality education MIST aims at providing learning with a technology edge. Right from its inception in 2001, it has tuning itself to meet this objective. It endeavors to provide consistent training to the students to help them evolve as competent professionals in the highly competitive world.

About the Department:

The Department of E.E.E is working with a mission to contribute through excellence in technical education, with research orientation. It imparts ethical & moral values to the student's so as to make them emerge as responsible professionals. With its experienced faculty members having excellent academic backgrounds, it trains students supplementing classroom lectures with computer aided demonstrations making their learning a rich and rewarding experience.

Contact Details:

Co-ordinator

Dr.R.V.Amarnath

Head EEE Dept,MIST

Co-convenor

Mr.G. Prem Kumar Reddy,

Assoc.Prof., EEE Dept,MIST

College Numbers: Tel: 04055810046,8979380692,

Email: e3hod.cec@gmail.com,

*A Two week Certificate Course
On*

**“Electrical Installation standards”
(12th - 28th sep 2017)**



Organizing Secretary

Chief Patrons

Sri. S.Sudershan Reddy, Chairman, MIST

Sri. S. Suender Reddy, Secretary, MIST

Sri S. Dhanurjay Reddy, Joint Secretary, MIST

Patron

Dr.KSSSN Reddy, Principal, MIST

Organized by



**Department of Electrical & Electronics
Engineering**

**Mahaveer Institute of Science & Technology
VyasaPuri, Bardlaguda, Hyderabad 500005.
(Affiliated to JNTUH)**

3. Electrical Installation Standards (5-1)		1	2	3	4	5	6	7	8	9	10	11	12	13	14	15	16	17	18	19	20	21	22	23	24	25	26	27	28	29	30
1	15E31A0201	ADARI UMASHANKAR	P	P	P	P	P	P	P	P	P	P	P	P	P	P	P	P	P	P	P	P	P	P	P	P	P	P	P	P	P
2	15E31A0203	ARRUM VAMSHIKRISHNA	P	P	P	P	P	P	P	P	P	P	P	P	P	P	P	P	P	P	P	P	P	P	P	P	P	P	P	P	P
3	15E31A0205	B AKHILA	P	P	P	P	P	P	P	P	P	P	P	P	P	P	P	P	P	P	P	P	P	P	P	P	P	P	P	P	P
4	15E31A0206	BALLE ARAVIND KUMAR	P	P	P	P	P	P	P	P	P	P	P	P	P	P	P	P	P	P	P	P	P	P	P	P	P	P	P	P	P
5	15E31A0207	BANOTH BALAJI	P	P	P	P	P	P	P	P	P	P	P	P	P	P	P	P	P	P	P	P	P	P	P	P	P	P	P	P	P
6	15E31A0208	BHUKYA PRAVALIKA	P	P	P	P	P	P	P	P	P	P	P	P	P	P	P	P	P	P	P	P	P	P	P	P	P	P	P	P	P
7	15E31A0209	BURRA HARISH	P	P	P	P	P	P	P	P	P	P	P	P	P	P	P	P	P	P	P	P	P	P	P	P	P	P	P	P	P
8	15E31A0210	CHEVITI VINAY KUMAR	P	P	P	P	P	P	P	P	P	P	P	P	P	P	P	P	P	P	P	P	P	P	P	P	P	P	P	P	P
9	15E31A0211	GANDI SAI KIRAN	P	P	P	P	P	P	P	P	P	P	P	P	P	P	P	P	P	P	P	P	P	P	P	P	P	P	P	P	P
10	15E31A0213	GUDA AVINASH	P	P	P	P	P	P	P	P	P	P	P	P	P	P	P	P	P	P	P	P	P	P	P	P	P	P	P	P	P
11	15E31A0216	KASHIEDDY SAI KIRAN RE-15	P	P	P	P	P	P	P	P	P	P	P	P	P	P	P	P	P	P	P	P	P	P	P	P	P	P	P	P	P
12	15E31A0217	KATAKAM ANUDEEP KUMAR	P	P	P	P	P	P	P	P	P	P	P	P	P	P	P	P	P	P	P	P	P	P	P	P	P	P	P	P	P
13	15E31A0218	KAVYA N	P	P	P	P	P	P	P	P	P	P	P	P	P	P	P	P	P	P	P	P	P	P	P	P	P	P	P	P	P
14	15E31A0219	KOKKULA SAIKIRAN	P	P	P	P	P	P	P	P	P	P	P	P	P	P	P	P	P	P	P	P	P	P	P	P	P	P	P	P	P
15	15E31A0221	KUCHOOR PRANEETHIDEEP	P	P	P	P	P	P	P	P	P	P	P	P	P	P	P	P	P	P	P	P	P	P	P	P	P	P	P	P	P
16	15E31A0222	KUSUNOJU MADHU	P	P	P	P	P	P	P	P	P	P	P	P	P	P	P	P	P	P	P	P	P	P	P	P	P	P	P	P	P
17	15E31A0224	NADDIPALLI KANCHANA	P	P	P	P	P	P	P	P	P	P	P	P	P	P	P	P	P	P	P	P	P	P	P	P	P	P	P	P	P
18	15E31A0225	NAKIDI ABHISHEK	P	P	P	P	P	P	P	P	P	P	P	P	P	P	P	P	P	P	P	P	P	P	P	P	P	P	P	P	P
19	15E31A0228	SHIVANNAGARI BHASKAR	P	P	P	P	P	P	P	P	P	P	P	P	P	P	P	P	P	P	P	P	P	P	P	P	P	P	P	P	P
20	15E31A0229	SILUSANI NAVYASRI	P	P	P	P	P	P	P	P	P	P	P	P	P	P	P	P	P	P	P	P	P	P	P	P	P	P	P	P	P
21	15E31A0230	SODI SRIKRISHNA	P	P	P	P	P	P	P	P	P	P	P	P	P	P	P	P	P	P	P	P	P	P	P	P	P	P	P	P	P
22	15E31A0231	THONGALA SHINEY	P	P	P	P	P	P	P	P	P	P	P	P	P	P	P	P	P	P	P	P	P	P	P	P	P	P	P	P	P
23	15E31A0233	YARUKALA SAI PRAKASHI	P	P	P	P	P	P	P	P	P	P	P	P	P	P	P	P	P	P	P	P	P	P	P	P	P	P	P	P	P
24	15E31A0234	J RAVI TEJA	P	P	P	P	P	P	P	P	P	P	P	P	P	P	P	P	P	P	P	P	P	P	P	P	P	P	P	P	P
25	16E35A0201	ALETI NISHITA	P	P	P	P	P	P	P	P	P	P	P	P	P	P	P	P	P	P	P	P	P	P	P	P	P	P	P	P	P
26	16E35A0203	JAKANAPALLY SHRISHEA	P	P	P	P	P	P	P	P	P	P	P	P	P	P	P	P	P	P	P	P	P	P	P	P	P	P	P	P	P
27	16E35A0204	JALLA ANJANEYULU	P	P	P	P	P	P	P	P	P	P	P	P	P	P	P	P	P	P	P	P	P	P	P	P	P	P	P	P	P
28	16E35A0205	KRISHNATEJA ALETI	P	P	P	P	P	P	P	P	P	P	P	P	P	P	P	P	P	P	P	P	P	P	P	P	P	P	P	P	P
29	16E35A0206	PEDDA GOLLA SHRISHA N	P	P	P	P	P	P	P	P	P	P	P	P	P	P	P	P	P	P	P	P	P	P	P	P	P	P	P	P	P
30	16E35A0207	PURI NARSING	P	P	P	P	P	P	P	P	P	P	P	P	P	P	P	P	P	P	P	P	P	P	P	P	P	P	P	P	P
31	16E35A0208	RAVULA PAVAN KUMAR	P	P	P	P	P	P	P	P	P	P	P	P	P	P	P	P	P	P	P	P	P	P	P	P	P	P	P	P	P
32	16E35A0209	SURYA SRAVANTHI	P	P	P	P	P	P	P	P	P	P	P	P	P	P	P	P	P	P	P	P	P	P	P	P	P	P	P	P	P
33	16E35A0210	VANGALA RANEETH KUMAR	P	P	P	P	P	P	P	P	P	P	P	P	P	P	P	P	P	P	P	P	P	P	P	P	P	P	P	P	P
34	16E35A0211	YALAGANDULA DURGA DUN	P	P	P	P	P	P	P	P	P	P	P	P	P	P	P	P	P	P	P	P	P	P	P	P	P	P	P	P	P
35	14E31A0206	B VENKATESH	P	P	P	P	P	P	P	P	P	P	P	P	P	P	P	P	P	P	P	P	P	P	P	P	P	P	P	P	P
36	14E31A0208	D DEVA RAJU	P	P	P	P	P	P	P	P	P	P	P	P	P	P	P	P	P	P	P	P	P	P	P	P	P	P	P	P	P
37	14E31A0209	DOMMATA BHASKAR	P	P	P	P	P	P	P	P	P	P	P	P	P	P	P	P	P	P	P	P	P	P	P	P	P	P	P	P	P
		Signature of the Faculty	P	P	P	P	P	P	P	P	P	P	P	P	P	P	P	P	P	P	P	P	P	P	P	P	P	P	P	P	P

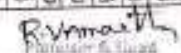
 R. V. Mani
 Professor & Head
 Dept. of Electrical & Electronic
 J. Jayar Institute of Science & Tech.
 Vysakapuri, Bandlaguda, Keshab,
 Hyderabad - 500 005.

MAHAVEER INSTITUTE OF SCIENCE AND TECHNOLOGY

(Affiliated to JNTUH, Hyderabad and Approved by AICTE, New Delhi)
Vyasapuri, Bandlaguda, Post: Keshavagiri, Hyderabad- 500005



organized by

Department of Electrical and Electronics Engineering.

CERTIFICATE

This is certify that **B.Harish** bearing Hall Ticket No **15E31A0209** of **B.Tc Third Year** has Participated in **Electrical Installation Standards Training Program** From **12-09-2017** to **25-09-2017** organized by **Department of Electrical and Electronics Engineering.**

Rv Amarnath

HOD
Dr.R.V.Amarnath

Dr.M.Rajendar Reddy

Dr.M.Rajendar Reddy
VITS

Dr.K.S.S.S.N.R

PRINCIPAL
Dr.K.S.S.S.N.R

Dr.K.S.S.S.N.R

PRINCIPAL
MAHAVEER
INSTITUTE OF SCIENCE & TECHNOLOGY
Bandlaguda, Hyd-500 005.

About the College

As an Institute committed in quality education, MIST aims at providing learning with a Technology-edge. It endeavors to provide consistent training to its students to help them evolve as competent professionals in the highly competitive world. Right from its inception in 2001, it has been tuning itself to meet this objective. A new civilization is emerging in our lives. This civilization brings with it a new way of working. Millions are already tuning their lives to the rhythms of tomorrow.

About the Mechanical Department

The Mechanical engineering is one of the core engineering departments, which has potential to accommodate all efficient engineers. The Mechanical engineers serve all other branches of engineering directly or indirectly. The Mechanical engineers can find their place in Automobile engineering sector, Steel Plants, Power plants, Software industries, Manufacturing industries, Design industries, Military, Naval and Air force, Defense research organizations, Material research organizations etc.

About the Workshop

AutoCAD is globally used by surveyors, designers, engineers, drafters. Globally, AutoCAD has proven as an efficient and user-friendly Program. Program. Commercial drafting and computer-aided design(CAD) software applications are AutoCAD. AutoCAD software is recognized internationally for its remarkable editing capabilities, which make it likely to digitally draw building plans or recreate 3D images. AutoCAD is compatible with other applications like 3D Max. The designers can even import or export DWG & DXG Files to the application. Also, these files can even be exported from AutoCAD to other applications for creating more improved projects & presentations.

Organising committee

CHIEF PATRON

Sri.S.Sudershan Reddy

Chairman

Sri. S. Surendar Reddy

Secretary

Sri S. Dhanunjay Reddy

Joint Secretary

DIRECTOR

Dr. H. S. N. Murthy

PATRON

Dr.K.S.S.S.Reddy, Principal

CONVENER

Dr.S.Murali,

Professor,Dept. Of Mechanical

PROGRAM COORDINATORS

Mr.S.Sudhakara

K.Devi Singh

Conducted On

2/5/2017- 12/5/2017



ESTD - 2011

MAHAVEER
INSTITUTE OF SCIENCE & TECHNOLOGY

Approved by AICTE, Affiliated to JNTU, Hyderabad.
Visision, Bandipada, Text: Keshavnagar, Hyderabad-500065.



Two week
Certification Course
on

Auto CAD

Organized by

Department of Mechanical
Engineering

Vysapuri, Bandlaguda Post, Keshavnagar,
Hyderabad-500 005, Telangana INDIA
Tel: 040-64556979, 20020773, Fax: 040-24455003
E-mail: principal@mahaveer@gmail.com,
Website: www.mist.ac.in,

MAHAVEER



Approved by AICTE, Affiliated to JNTU(Hydr)

Date: 29-04-2017

To
The Principal
MIST,
Hyderabad.

Sub: Proposal for Add-on Course-Reg.

Respected sir,

We are going to conduct 10 days Technical Training for II B. Tech students on "Introduction to Auto CAD". We require your approval to go head for proceeding and hope to get an opportunity to serve you the best.

With thanks and regards

Dr.S.Murali

HOD

Department of Mechanical Engineering



Date: 01.05.2017

CIRCULAR

Technical Training for II B. Tech students are starting from 2nd MAY, 2017 onwards. All HODs and Placements coordinators have to manage the trainings and ensure 95% attendance all through the sessions.

All Mentors need to send the compiled feedback report to Dr.S.Murali, HOD at e3hod.mech@gmail.com daily.

Agenda: 1. Introduction to AUTOCAD.

Design and Development of curriculum for Add on course:

Name of the Faculty : S.SUDHAKARA

Dr.S.Murali

HOD

Department of Mechanical Engineering

Kishu
PRINCIPAL
MAHAVEER
INSTITUTE OF SCIENCE & TECHNOLOGY
Bandlaguda, Hyd-500 005.



Auto CAD SYLLABUS

1: Getting Started with AutoCAD

- Opening and Creating Drawings
- Exploring the AutoCAD interface
- Zooming and Panning

2: Basic Drawing & Editing Commands

- Using the Mouse, Keyboard, and Enter Key to work quickly and efficiently in AutoCAD
- Lines
- Circles
- Rectangles

3: Projects - Creating a Simple Drawing

- Creating Simple Drawings
- Using Object Snap Tracking to extrapolate a projected top view
- Using Modify tools to arrange an office layout

4: Drawing Precision in AutoCAD

- Polar and Ortho Tracking
- Entering Coordinates and Angles
- Object Snaps and Tracking

5: Making Changes in Your Drawing

- Move
- Copy
- Rotate
- Mirror
- Scale
- Using the reference option with the Scale Tool

7: Organizing Your Drawing with Layers

- Layer States
- Properties by Layer
- Layer Tools

8: Advanced Object Types

- Polylines

Handwritten signature

THE

Handwritten text



- Arcs
- Polygons
- Ellipses

9: Advanced Editing Commands

- Trim and Extend
- Fillet and Chamfer
- Polyline Edit and Spline
- Offset and Explode
- Join

10: Inserting Blocks

- The Insert Block Command
- Inserting Blocks with Tool Palettes
- Dynamic Bloes
- Migrating Blocks and other Elements between Drawings with Design Center

11: Text

- The Multiline Text Tool
- The Single Line Text Tool
- Editing Text
- Text in Model Space vs. Paper Space
- The Multileader Tool

12: Hatching

- The Hatch Command
- The Hatch Editor/Ribbon Tab
- Saving and Applying Hatches with Tool Palettes

13: Adding Dimensions

- Using Dimensioning Tools
- Dimensioning in a Layout Tab vs. the Model Tab
- Using Dimension Styles
- Editing Dimensions

14: Projects - Annotating Your Drawing

- Dimensioning a Mechanical Drawing

K. Srinivas
Principal
MAHAVEER INSTITUTE OF TECHNOLOGY AND ENGINEERING
BANDLAGUDA, HYDRABAD-500021



Department of Mechanical Engineering Auto CAD Technical Training student attendance list 2017-18

S.NO.	ROLL NO.	NAME OF THE STUDENT	YEAR
1	16E31A0301	B PRAVEEN KUMAR	II
2	16E31A0305	G RAMAKRISHNA	II
3	16E31A0306	G VENU GOPAL	II
4	16E31A0307	GADDI SUDHAMSHU	II
5	16E31A0308	GAJELLI VAMSHI KRISHNA	II
6	16E31A0313	KOVA SAIKUMAR	II
7	16E31A0314	LUNAVATH GANESH	II
8	16E31A0318	MOHAMMED MUBEEN QURESHI	II
9	16E31A0319	MOHD ABDUL SAMEER	II
10	16E31A0320	MOHD ABDUL AHTESHAM UL HASNAIN	II
11	16E31A0323	N SRIKANTH REDDY	II
12	16E31A0324	NALLA TEJASWI	II
13	16E31A0325	PANUGANTI SAI KIRAN GOUD	II
14	16E31A0326	PATLOLLA PRASHANTH REDDY	II
15	16E31A0327	PONNURU UPENDRA	II
16	16E31A0328	PULJALA ANIL	II
17	16E31A0329	PUNEET RAJ CHAVAN	II
18	16E31A0330	PUTTAPAD YADAAIAH	II
19	16E31A0331	R VAYU PUTHRA	II
20	16E31A0332	RAMAKRISHNA LAKMALA	II
21	16E31A0333	RAVULA HEMANTH KUMAR	II
22	16E31A0334	SHAIK MUJAFFER	II

K. S. S.

PRINCIPAL
EER

Vycapuri, Bandlaguda Post Keshaupuri,
Hyderabad 503 005, Telangana, INDIA
Tel: 040-64596379, 20020773, Fax: 040-24455003
E-mail: principal.mahaveer@gmail.com
Website: www.mst.ac.in

MAHAVEER



Approved by AICTE. Affiliated to JNTU (H) Hyd.

23	16E31A0336	SYED ZAINUDDIN ABED	II
24	16E31A0337	TEJAVATH SRIKANTH	II
25	16E31A0338	THONGAR NARAYANA	II
26	16E31A0339	THOTA PAVAN KUMAR	II
27	16E31A0340	YELTI SREYA	II
28	16E31A0342	ABU SUFYAN MALIK	II
29	16E31A0343	AKASH SABHANI	II
30	16E31A0344	AMERINANI ANIL KUMAR	II
31	16E31A0345	ARAKALA SHIVA	II
32	16E31A0346	BAGI VIJENDER REDDY	II
33	16E31A0350	DEVI SHRI PRASAD PATANGI	II
34	16E31A0351	EDAM SAIRAM	II
35	16E31A0352	ERLA MAHENDRA KUMAR	II
36	16E31A0353	ISHRATH UNNISA BEGUM	II
37	16E31A0354	KATPALLY SRENU REDDY	II
38	16E31A0356	KOLLA RAJASHEKAR REDDY	II
39	16E31A0358	KOMMIDI SHRAVAN REDDY	II
40	16E31A0360	KOTHALAPURAM ANUSHA	II
41	16E31A0361	KUDUTHALA AKHIL	II
42	16E31A0362	MADHAGONE AKHIL TEJA	II
43	16E31A0364	MOHAMMED LUQMAN ZAKI	II
44	16E31A0365	MOHAMMED RIZWANUDDIN	II
45	16E31A0368	PATHAKOTI JAGADISH	II
46	16E31A0369	PULUGARI JAGADEESHWAR REDDY	II
47	16E31A0370	PYATA PRASHANTH KUMAR	II
48	16E31A0371	SHAIK SAMEER	II

K. Subhiksha
MAHAVEER
Principal
Vycapuri, Bandlaguda Post Keshaupuri,
Hyderabad 503 005, Telangana, INDIA
Tel: 040-64596379, 20020773, Fax: 040-24455003
E-mail: principal.mahaveer@gmail.com
Website: www.mst.ac.in

Vysapur, Bandlaguda Post Keshavnagar,
Hyderabad-500 005, Telangana INDIA.
Tel: 040-64596975, 26826773, Fax: 040-24455003
E-mail: principal.mahaveer@gmail.com
Website: www.mist.ac.in

MAHAVEER



Approved by AICTE, Affiliated to JNTU, Hyd

49	16E31A0374	SYED OMAIR AHMED	II
50	16E31A0376	TUMMALA PALLY VINAY REDDY	II
51	16E31A0377	V SHIVA KUMAR REDDY	II
52	16E31A0378	VALGOTE NIKHIL KUMAR	II
53	16E31A0379	YATA VISHNUVARDHAN REDDY	II
54	15E31A0324	K SAI TEJA	II
55	15E31A0323	K RAJESH	II
56	15E31A0326	MD ABUBAKAR SIDDIQ	II
57	17E35A0301	ALAKANTI SWARAJYAM	II
58	17E35A0302	B MAHESH	II
59	17E35A0303	BHOOMENI VENKATA SAI	II
60	17E35A0304	BODIGAM SRINATH	II
61	17E35A0305	GOMASA HARSHAVARDHAN	II
62	17E35A0306	JAMPALA SAIKUMAR	II
63	17E35A0307	KAIRAMKONDA SURESH	II
64	17E35A0308	KARISHA SURESH	II
65	17E35A0309	KONKATA KARTHIK	II
66	17E35A0310	KUMMARA PAVANKUMAR	II
67	17E35A0311	MAHESH	II
68	17E35A0312	MD ASIF	II
69	17E35A0313	MOGUNURI NARENDRA	II
70	17E35A0314	MOHAMMED ABDUL RAQEEB	II
71	17E35A0316	PAISHETTY NAGA VAMSHI	II
72	17E35A0317	PANTHULU TARUN KUMAR	II
73	17E35A0318	PORISHETTI BHANUCHANDER	II
74	17E35A0319	SAMSARBANDA RAGHAVENDRA REDDY	II

PRINCIPAL
K. Srinivas Reddy
INSTITUTE OF MANAGEMENT & TECHNOLOGY
Bandlaguda, Hyderabad-500005

Vysavi: Banilaguda Post Resthaugiri,
Hyderabad-500 005, Telangana INDIA
Tel: 040-64596979, 20020773, Fax: 040-24455003
E-mail: prntipal@mahaveer@gmail.com
Website: www.mahaveer.ac.in

MAHAVEER



Approved by AICTE, Affiliated to JNTU Hydr

75	17E35A0320	SHAIK MINHAJ UDDIN	II
76	17E35A0321	SYED SOHAIL AHMED	II
77	17E35A0322	VADLA SRIKANTH	II
78	15E31A0335	MOHD ABDUL HASEEB	II
69	17E35A0313	MOGUNURI NARENDRA	II
70	17E35A0314	MOHAMMED ABDUL RAQEEB	II
71	17E35A0316	PAISHETTY NAGA VAMSHI	II
72	17E35A0317	PANTHULU TARUN KUMAR	II
73	17E35A0318	PORISHETTI BHANUCHANDER	II
74	17E35A0319	SAMSARBANDA RAGHAVENDRA REDDY	II
75	17E35A0320	SHAIK MINHAJ UDDIN	II
76	17E35A0321	SYED SOHAIL AHMED	II
77	17E35A0322	VADLA SRIKANTH	II
78	15E31A0335	MOHD ABDUL HASEEB	II

Mahaveer
INSTITUTE OF MANAGEMENT STUDIES
Banilaguda, Hyderabad-500005



Department of Mechanical Engineering
Auto CAD Technical Training student Marks list 2017-18

S.NO	Roll No	Name of the student	YEAR	MARKS	PASS/FAIL
1	16E31A0301	B PRAVEEN KUMAR	II	15	PASS
2	16E31A0305	G RAMAKRISHNA	II	15	PASS
3	16E31A0306	G VENU GOPAL	II	16	PASS
4	16E31A0307	GADDI SUDHAMISHU	II	15	PASS
5	16E31A0308	GAJELLI VAMSHI KRISHNA	II	15	PASS
6	16E31A0313	KOVA SAIKUMAR	II	15	PASS
7	16E31A0314	LUNAVATH GANESH	II	15	PASS
8	16E31A0318	MOHAMMED MUBEEN QURESHI	II	16	PASS
9	16E31A0319	MOHD ABDUL SAMEER	II	15	PASS
10	16E31A0320	MOHD ABDUL AHTESHAM UL HASNAIN	II	14	PASS
11	16E31A0323	N SRIKANTH REDDY	II	18	PASS
12	16E31A0324	NALLA TEJASWI	II	15	PASS
13	16E31A0325	PANUGANTI SAI KIRAN GOUD	II	16	PASS
14	16E31A0326	PATLOLLA PRASHANTH REDDY	II	16	PASS
15	16E31A0327	PONNURU UPENDRA	II	15	PASS
16	16E31A0328	PULJALA ANIL	II	16	PASS
17	16E31A0329	PUNEET RAJ CHAVAN	II	16	PASS
18	16E31A0330	PUTTAPAD YADAAIAH	II	16	PASS
19	16E31A0331	R VAYU PUTHRA	II	16	PASS
20	16E31A0332	RAMAKRISHNA LAKMALA	II	16	PASS
21	16E31A0333	RAVULA HEMANTH KUMAR	II	16	PASS
22	16E31A0334	SHAIK MUJAFER	II	15	PASS
23	16E31A0336	SYED ZAINUDDIN ABED	II	15	PASS

Handwritten signature and stamp

Vysarpur, Barhaguda Post, Keshavnagar,
Hyderabad-501 001, Telangana INDIA
Tel: 040-84888979/20208773 Fax: 040-24433003
E-mail: principal@mahaveer.com
Website: www.mahaveer.com

MAHAVEER



Approved by AICTE, Hyderabad on 28/10/2014

24	16E31A0337	TEJAVATHI SRIKANTHI	II	15	PASS
25	16E31A0338	THONGAR NARAYANA	II	15	PASS
26	16E31A0339	THOTA PAVAN KUMAR	II	15	PASS
27	16E31A0340	YELTI SREYA	II	15	PASS
28	16E31A0342	ABU SUFYAN MALIK	II	15	PASS
29	16E31A0343	AKASH SABBHANI	II	16	PASS
30	16E31A0344	AMERINANI ANIL KUMAR	II	15	PASS
31	16E31A0345	ARAKALA SHIVA	II	14	PASS
32	16E31A0346	BAGI VIJENDER REDDY	II	18	PASS
33	16E31A0350	DEVI SHRI PRASAD PATANGI	II	15	PASS
34	16E31A0351	EDAM SAIRAM	II	16	PASS
35	16E31A0352	ERLA MAHENDRA KUMAR	II	16	PASS
36	16E31A0353	ISHRATH UNNISA BEGUM	II	15	PASS
37	16E31A0354	KATPALLY SRENU REDDY	II	16	PASS
38	16E31A0356	KOLLA RAJASHEKAR REDDY	II	15	PASS
39	16E31A0358	KOMMIDI SHRAVAN REDDY	II	14	PASS
40	16E31A0360	KOTHALAPURAM ANUSHA	II	18	PASS
41	16E31A0361	KUDUTHALA AKHIL	II	15	PASS
42	16E31A0362	MADHAGONE AKHIL TEJA	II	16	PASS
43	16E31A0364	MOHAMMED LUQMAN ZAKI	II	16	PASS
44	16E31A0365	MOHAMMED RIZWANUDDIN	II	15	PASS
45	16E31A0368	PATHAKOTI JAGADISH	II	16	PASS
46	16E31A0369	PULUGARI JAGADEESHWAR REDDY	II	14	PASS
47	16E31A0370	PYATA PRASHANTH KUMAR	II	18	PASS
48	16E31A0371	SHAIK SAMEER	II	15	PASS
49	16E31A0374	SYED OMAIR AHMED	II	16	PASS

K. Srinivas
Principal
MAHAVEER
Vysarpur, Barhaguda Post,
Keshavnagar, Hyderabad-501 001

Vysapuri, Gandlaguda Post, Keshavnagar,
Hyderabad 502 025, Telangana INDIA
Tel: 040-6450679, 20020773, Fax: 040-24450003
E-mail: principal.mahaveer@gmail.com
Website: www.mst.ac.in

MAHAVEER



Approved by AICTE, Affiliated to JNTU-Hyd

50	16E31A0376	TUMMALA PALLY VINAY REDDY	II	15	PASS
51	16E31A0377	V SHIVA KUMAR REDDY	II	16	PASS
52	16E31A0378	VALGOTE NIKHIL KUMAR	II	15	PASS
53	16E31A0379	YATA VISHNUVARDHAN REDDY	II	16	PASS
54	15E31A0324	K SAI TEJA	II	15	PASS
55	15E31A0323	K RAJESH	II	14	PASS
56	15E31A0326	MD ABUBAKAR SIDDIQ	II	18	PASS
57	17E35A0301	ALAKANTI SWARAJYAM	II	15	PASS
58	17E35A0302	B MAHESH	II	16	PASS
59	17E35A0303	BHOOMENI VENKATA SAI	II	15	PASS
60	17E35A0304	BODIGAM SRINATH	II	16	PASS
61	17E35A0305	GOMASA HARSHAVARDHAN	II	15	PASS
62	17E35A0306	JAMPALA SAIKUMAR	II	16	PASS
63	17E35A0307	KAIRAMKONDA SURESH	II	15	PASS
64	17E35A0308	KARISHA SURESH	II	14	PASS
65	17E35A0309	KONKATA KARTHIK	II	18	PASS
66	17E35A0310	KUMMARA PAVANKUMAR	II	15	PASS
67	17E35A0311	MAHESH	II	16	PASS
68	17E35A0312	MD ASIF	II	16	PASS
69	17E35A0313	MOGUNURI NARENDRA	II	15	PASS
70	17E35A0314	MOHAMMED ABDUL RAQEEB	II	16	PASS
71	17E35A0316	PAISHETTY NAGA VAMSHI	II	15	PASS
72	17E35A0317	PANTHULU TARUN KUMAR	II	14	PASS
73	17E35A0318	PORISHETTI BHANUCHANDER	II	18	PASS
74	17E35A0319	SAMSARBANDA RAGHAVENDRA REDDY	II	15	PASS
75	17E35A0320	SHAIK MINHAIJ UDDIN	II	16	PASS

K. Srinivas
Principal
Mahaveer Institute of Technology
Gandlaguda, Hyderabad-502025

Nyapam, Bandlaguda Post, Neechavgni,
Hyderabad 500 005, Telangana INDIA
Tel: 040-64396979, 20020773, Fax: 040-24155003
E-mail: principal.mahaveer@gmail.com
Website: www.mahaveer.ac.in

MAHAVEER



Approved by AICTE, Affiliated to JNTUHHyd.

76	17E35A0321	SYED SOHAIL AHMED	II	16	PASS
77	17E35A0322	VADLA SRIKANTH	II	15	PASS
78	15E31A0335	MOHD ABDUL HASEEB	II	16	PASS

Khanif
PRINCIPAL
MAHAVEER
INSTITUTE
Bandlaguda, Hyd-500 005



Auto CAD COURSE Summary

Department of Mechanical Engineering

- Use AutoCAD for daily working process.
- Navigate throughout AutoCAD using major navigating tools.
- Understand the concepts and techniques to draw.
- Create multiple designs using several of tools.
- Create layers to control the objects' visibility.
- Explain drawing using annotations.
- Plot or print the drawing by scale.
- To use constraint for certain design.

Copy to :

1. Department of Notice Board
2. Principal for Information
3. Committee Members(Academic)

Kishor
Principal
Date: 25/05/2024
Back: 25/05/2024, Hyderabad-500 005.

Venapur, Bandlaguda Post Keshavnagar,
Hyderabad 500 025, Telangana INDIA
Tel: 040-64596979, 20029773, Fax: 040-24455003
E-mail: principal.mahaveer@gmail.com,
Website: www.mahaveer.ac.in

MAHAVEER



Approved by AICTE. Affiliated to JNTU(Hydr)

CERTIFICATE OF COURSE COMPLETION

This certificate is presented to Yetti Sreya of
MIST, who has successfully completed technical training course on
"Auto CAD" held from 02-05-2017 to 12-05-2017 and found the
student performance to be excellent.

K. Srinivas
PRINCIPAL
MAHAVEER
INSTITUTE OF SCIENCE & TECHNOLOGY
3rd Floor, Venapur, Hyd-500 025



ESTD : 2001

Dr. S. Srinivas

HOD

Department of Mechanical Engineering

Vysaquare, Bangalore Post, Karnataka
 Hyderabad-500 005, Telangana 500003
 Tel: 040-64596979, 20020773, Fax: 040-6459003
 E-mail: principal.mech@mvn.ac.in
 Website: www.mvn.ac.in



DEPARTMENT OF MECHANICAL ENGINEERING

List of students enrolled in Auto CAD (2017-2018)												
S.No	Roll No	Date	2/18/17	3/5/17	4/5/17	5/12/17	6/12/17	7/12/17	8/12/17	9/12/17	10/12/17	11/12/17
		Name of the student										
1	16E31A0301	B PRAVEEN KUMAR	P	P	P	P	P	P	P	P	P	P
2	16E31A0305	GRAMAKRISHNA	P	P	P	P	P	P	P	P	P	P
3	16E31A0306	GVENU GOPAL	P	P	P	P	P	P	P	P	P	P
4	16E31A0307	GADDE SUDHANSHU	P	P	P	P	P	P	P	P	P	P
5	16E31A0308	GAJELLI VAMSU KRISHNA	P	P	P	P	P	P	P	P	P	P
6	16E31A0313	KOVA SAKETUMAU	P	P	P	P	P	P	P	P	P	P
7	16E31A0314	LUNAVATHI GANESH	P	P	P	P	P	P	P	P	P	P
8	16E31A0318	MOHAMMED MUBEEN QURESHI	P	P	P	P	P	P	P	P	P	P
9	16E31A0319	MOHD ABDUL SAMEER	P	P	P	P	P	P	P	P	P	P

Kishu



MAHAVEER
INSTITUTE OF SCIENCE & TECHNOLOGY

Approved by AICTE, Affiliated to JNTU, Hyderabad.
Vidyanagar, Bandlaguda, Post: Madhavapuri, Hyderabad-500015.

ESTD - 2002

Organizing committee

CHIEF PATRON

Sri.S.Sudershan Reddy

Chairman

Sri. S. Surendar Reddy

Secretary

Sri S. Dhanunjay Reddy

Joint Secretary

DIRECTOR

Dr. H. S. N. Murthy

PATRON

Dr K.S.S.N Reddy. Principal

CONVENER

Dr.S.Murall

Professor, Dept. Of Mechanical

PROGRAM COORDINATORS

N.Sathish Kumar

Duration

02/05/2017 -12/5/2017

About the College

As an Institute committed in quality education, MIST aims at providing learning with a Technology-edge. It endeavors to provide consistent training to its students to help them evolve as competent professionals in the highly competitive world. Right from its inception in 2001, it has been tuning itself to meet this objective. A new civilization is emerging in our lives. This civilization brings with it a new way of working. Millions are already tuning their lives to the rhythms of tomorrow.

About the Mechanical Dept.

The Mechanical engineering is one of the core engineering departments, which has potential to accommodate all efficient engineers. The Mechanical engineers serve all other branches of engineering directly or indirectly. The Mechanical engineers can find their place in Automobile engineering sector, Steel Plants, Power plants, Software industries, Manufacturing industries, Design industries, Military, Naval and Air force, Defense research organizations, Material research organizations etc.

About the Workshop

CATIA delivers the unique ability not only to model any product, but to do so in the context of its real-life behavior design in the age of experience. CATIA (Computer-Aided Three dimensional Interactive Application) software is a complete multi-platform solution for computer-aided design, manufacturing, engineering, 3D and PLM. Marketed by manufacturer Dassault Systemes, the software is ideal for creating solids, surfaces, assemblies, drawings, fabrication and analysis. However, CATIA offers more advanced functionality for surfaces and modules for different industries.



**Two week
Certification Course
on**

Introduction to CATIA

Organized by

**Department of Mechanical
Engineering**

Vysapuri, Bandlaguda Post, Keshavnagar,
Hyderabad-500 005, Telangana INDIA
Tel: 040-64556979, 20020773, Fax: 040-24455001
E-mail: principal.mahaveer@gmail.com,
Website: www.mist.ac.in

MAHAVEER



Approved by AICTE - Affiliated to JNTUHYDR

Date: 29-04-2017

To
The Principal
MIST,
Hyderabad.

Sub: Proposal for Add-on Course-Reg.

Respected sir,

We are going to conduct 10 days Technical Training for III B. Tech students on "Introduction to CATIA". We require your approval to go head for proceeding and hope to get an opportunity to serve you the best.

With thanks and regards

MAHAVEER
INSTITUTE OF TECHNOLOGY
BANDLAGUDA POST, VYSAPURI,
KESHAVNAGAR, HYDERABAD-500005

Dr.S.Murali

HOD

Department of Mechanical Engineering



Date: 01.05.2017

CIRCULAR

Technical Training for III B. Tech students are starting from 2nd MAY, 2017 onwards. All HODs and Placements coordinators have to manage the trainings and ensure 95% attendance all through the sessions.

All Mentors need to send the compiled feedback report to Dr.S.Murali, HOD .

Agenda:

I. Introduction to CATIA.

Design and Development of curriculum for Add on course:

Name of the Faculty: N.Satish Kumar

PRINCIPAL
MAHAVEER
INSTITUTE OF SCIENCE & TECHNOLOGY
Bandlaguda, Hyd-500 005.

Dr.S.Murali
HOD
Department of Mechanical Engineering



CATIA SYLLABUS

Total Hours: 48

I. Introduction:

- Modulus
- Features (powerful Tools
- Parametric modeling
- Feature based approach
- Parent – child Relationship)
- Associative and Model Centric
- b) Information about Interface
- Tools, Menu, etc.

II. Sketcher:

- Getting Started
- Interface
- Sketch tools
- Profiles
- Operations
- Constraints
- Sketcher preferences
- References

III. Part Features:

- Sketch Based Features
- Pad
- Pocket
- Thin
- Shaft
- Groove

K. Mahaveer
PRINCIPAL
MAHAVEER
INSTITUTE OF TECHNOLOGY
VYSAPURI, BANDLAGUDA POST, KESHAVGI,
HYDERABAD-500 605, TELANGANA INDIA

- Hole
- Threaded Hole
- Rib
- Slot & Stiffener
- Multi section solid

IV. Dress-up Features

- Fillet
- Chamfer
- Draft
- Shell
- Thickness
- Thread/Tap

V. Reference Element

- Point
- Line
- Plane

VI. Assembly Modeling:

- Assembly Constraints
- Manipulation
- Defining a multi & fast multi-instantiation
- Analyzing an assembly

VII. Drafting:

- Sheets & Views
- View modification
- Generating dimensions
- Bill of material
- Dimensions
- Annotations
- Dress up Elements
- Properties
- Exporting and Importing files

Handwritten signature
 M. S. ...
 ...



Department of Mechanical Engineering CATIA Technical Training student attendance list 2017-18

S.NO.	ROLL NO.	NAME OF THE STUDENT	YEAR
1	15E31A0301	ABDUL ABRAR	III
2	15E31A0302	ABDUL RAHMAN	III
3	15E31A0303	ANAND KUMAR	III
4	15E31A0304	AQUEEB UDDIN FIRDUSI	III
5	15E31A0305	ATTLURI SURESH REDDY	III
6	15E31A0306	BANDA SATYA SHIVA REDDY	III
7	15E31A0310	BHOOMENI NARENDIAR	III
8	15E31A0311	BICHKUNDA SUNIL KUMAR	III
9	15E31A0313	CHIDIRALA RAJKUMAR	III
10	15E31A0315	DESHAGOUNI MOHAN SAI	III
11	15E31A0317	GURRALA VENKATA NARSI REDDY	III
12	15E31A0318	HUSSAIN FAIZ ULLAH	III
13	15E31A0319	K SAMPATH	III
14	15E31A0320	KASIREDDY SAIMANOJ REDDY	III
15	15E31A0321	KATTA SRIKANTH REDDY	III
16	15E31A0322	KESHETTI NIKHIL	III
17	15E31A0325	M A LATEEF	III
18	15E31A0327	MANCHIKANTI ARAVIND REDDY	III
19	15E31A0329	MD UBED UL RAHMAN	III
20	15E31A0331	MOHAMMED ABDULLAH ZUBAIR	III
21	15E31A0332	MOHAMMED AJAZ	III
22	15E31A0333	MOHAMMED ISMAIL FURQAN	III
23	15E31A0334	MOHD ABDUL ATIF	III

K. S. V.
PRINCIPAL
MAHAVEER
INSTITUTE OF SCIENCE & TECHNOLOGY
BANDLAGUDA, HYD-500 005

Vysapuri, Bandlaguda Post, Keethavgil,
Hyderabad-500 005, Telangana INDIA.
Tel: 240-84596979, 20020773, Fax: 040-24455003
E-mail: princ.gal.mahaveer@gmail.com,
Website: www.mahaveer.in

MAHAVEER



Approved by AICTE, Affiliated to JNTU, Hyd

24	15E31A0336	MOHD ASIM KHAN	III
25	15E31A0337	MOHD FARHAN AHMED SHARIF	III
26	15E31A0338	MOHD SALA UDDIN	III
27	15E31A0340	MOHD TALHA	III
28	15E31A0341	MUDAVATH SRINIVAS	III
29	15E31A0342	NELLURI AJAY KUMAR	III
30	15E31A0343	PADAMATINTI AVINASHI	III
31	15E31A0344	PALNATI SRIKANTH REDDY	III
32	15E31A0346	POLAKA PARDHA SARADHI REDDY	III
33	15E31A0349	SABHAVAT SEVYA	III
34	15E31A0350	SHADMAN ASHRAF	III
35	15E31A0351	SHAIK ABDUL SAIF	III
36	15E31A0352	SHAIK ARIF HUSSAIN	III
37	15E31A0354	SOHAIL MOHAMMED MASOOD AHMED KHAN	III
38	15E31A0356	SYED BAHAUDDIN	III
39	15E31A0360	SYED QAMAR UDDIN RAZA SHAH QUADRI	III
40	15E31A0361	SYED SHAHED AHMED	III
41	15E31A0362	T KULDEEP SINGH	III
42	15E31A0363	TANNEERU RAJA	III
43	15E31A0365	VANGAPALLY SRINIVAS	III
44	16E35A0301	AMAR BIRADAR	III
45	16E35A0302	BHUKYA RAMA	III
46	16E35A0303	DIHARAVATH RAVINDER NAYAK	III
47	16E35A0304	EROJI SURESH	III
48	16E35A0305	GOURAV KUMAR JHA	III
49	16E35A0306	KALIKOTA SAI CHARAN	III

K. Sankar
PRINCIPAL
MAHAVEER
INSTITUTE OF TECHNOLOGY
Bandlaguda, Hyderabad

Vysapuri, Bandlaguda Post Keshavnagar,
Hyderabad-500 005, Telangana INDIA.
Tel: 040-64596379,20020773, Fax: 040-24451003
E-mail: principal.mahaveer@gmail.com
Website: www.mist.ac.in

MAHAVEER



Approved by AICTE, Affiliated to JNTU(Hyd)

50	16E35A0307	MIANYALA SAIJEJA	III
51	16E35A0308	TADEMIBHARATHI KUMAR	III
52	16E35A0310	TANGELLA ASHOKA VARDHAN RAJU	III
53	14E31A0303	ANSAR AHMED KHAN	III
54	14E31A0334	MOHAMMED ABRAR AHMED	III
55	14E31A0335	MOHAMMED AKIF AHMED	III
56	14E31A0373	G KARTHIK RAJ	III
57	14E31A0374	A KAUSHIK VILAS	III
58	14E31A0386	MOHAMMED SOHAIB	III
59	14E31A0397	SYED SIKANDER ALI	III
60	14E31A0398	SYED VIKAYAT ULLAH	III
61	15E35A0301	E MADHUKAR	III
62	13E31A0304	AKASH HANVETHI	III
63	14E31A0390	RAHUL SINGH	III
64	14E31A0376	IMAMD HASAN KHAN	III
65	14E31A0359	TAMMARASHI AJAY KUMAR	III
66	13E31A0350	S KUNAL	III
67	14E31A0341	MOHD KHAHA MOHIUDDIN	III
68	14E31A0352	SAIFULLAH EKARAN JALKOTE	III
69	14E31A0337	MOHD ADNAN AZHAR	III
70	14E31A0339	MOHD ABDUL HAMEED GOURI	III

K. S. S.
PRINCIPAL
MAHAVEER
INSTITUTE OF SCIENCE & TECHNOLOGY
Bandlaguda, Hyd-500 005.



Technical Training Exam on Catia Software (A.Y-2017-18)

2x10=20 Marks

Answer All the Questions

1. Draw the given figure by using Catia software.

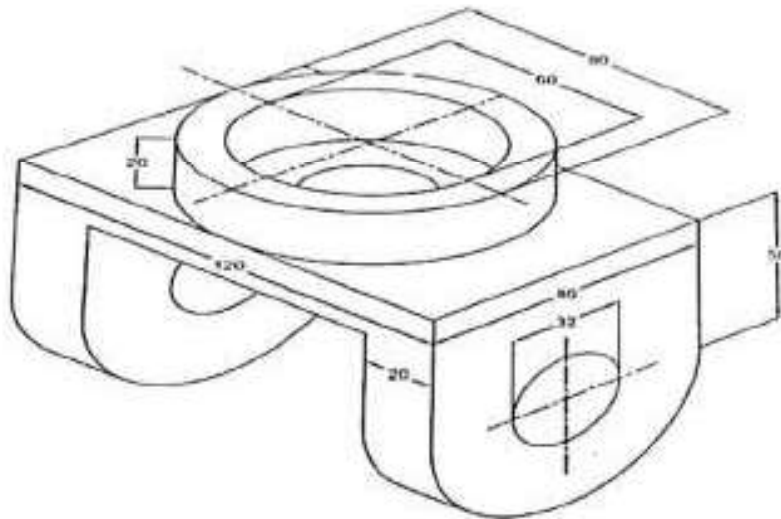

2. Draw the given 2D model into 3D model by using Catia.

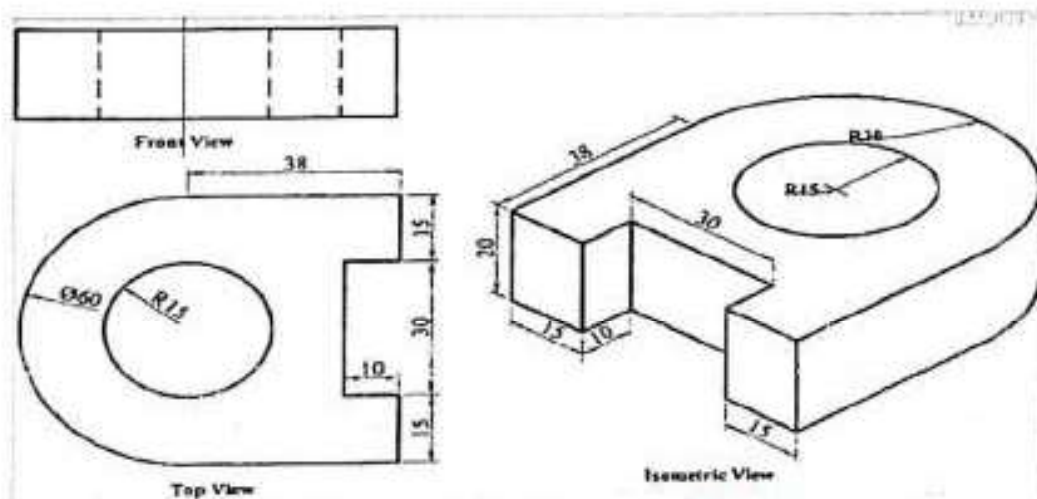

Principal
MAHAVEER
INSTITUTE OF SCIENCE & TECHNOLOGY
Bandlaguda, Hyd-500 065

Vysapuri, Bandlaguda Post Keshavnagar,
Hyderabad-500 095, Telangana INDIA
Tel: 040-6459579, 32020173, Fax: 040-24455003
E-mail: principal.mahaveer@gmail.com
Website: www.mst.ac.in

MAHAVEER



Approved by AICTE, Affiliated to JNTUHYD

Department of Mechanical Engineering
CATIA Technical Training student Marks list 2017-18

Sl.NO	Roll No	Name of the student	YEAR	MARKS	PASS/FAIL
1	15E31A0301	ABDUL ABBAR	III	15	PASS
2	15E31A0302	ABDUL RAHMAN	III	16	PASS
3	15E31A0303	ANAND KUMAR	III	14	PASS
4	15E31A0304	AQUEEB UDDIN FIRDUSHI	III	15	PASS
5	15E31A0305	ATTLURI SURESH REDDY	III	17	PASS
6	15E31A0306	BANDA SATYA SHIVA REDDY	III	15	PASS
7	15E31A0310	BHOOMENI NARENDHAR	III	16	PASS
8	15E31A0311	BICHKUNDA SUNIL KUMAR	III	16	PASS
9	15E31A0313	CHIDIRALA RAJKUMAR	III	15	PASS
10	15E31A0315	DESHAGOUNI MOHAN SAI	III	15	PASS
11	15E31A0317	GURRALA VENKATA NARSI REDDY	III	16	PASS
12	15E31A0318	HUSSAIN FAIZ ULLAH	III	14	PASS
13	15E31A0319	K SAMPATH	III	15	PASS
14	15E31A0320	KASIREDDY SAIMANOJ REDDY	III	15	PASS
15	15E31A0321	KATTA SRIKANTH REDDY	III	16	PASS
16	15E31A0322	KESHETTI NIKHIL	III	14	PASS
17	15E31A0325	M A LATEEF	III	15	PASS
18	15E31A0327	MANCHIKANTI ARAVIND REDDY	III	17	PASS
19	15E31A0329	MD UBED UL RAHMAN	III	15	PASS
20	15E31A0331	MOHAMMED ABDULLAH ZUBAIR	III	16	PASS
21	15E31A0332	MOHAMMED AIJAZ	III	16	PASS
22	15E31A0333	MOHAMMED ISMAIL FURQAN	III	15	PASS
23	15E31A0334	MOHD ABDUL ATIF	III	16	PASS

K. Sub.

Principal
Department of Mechanical Engineering
Mahaveer Institute of Technology
Hyderabad

Vysapuri, Bandlaguda Post Keshavnagar,
Hyderabad-500 005, Telangana INDIA
Tel: 040-64505379, 26020773, Fax: 040-24455003
E-mail: principal.mahaveer@gmail.com
Website: www.mst.ac.in

MAHAVEER



Approved by AICTE, Affiliated to JNTUH Hyd

24	15E31A0336	MOHID ASIM KHAN	III	14	PASS
25	15E31A0337	MOHID FARHAN AHMED SHARIF	III	15	PASS
26	15E31A0338	MOHID SALA UDDIN	III	15	PASS
27	15E31A0340	MOHID TALHA	III	16	PASS
28	15E31A0341	MUDAVATH SRINIVAS	III	14	PASS
29	15E31A0342	NELLURI AJAY KUMAR	III	16	PASS
30	15E31A0343	PADAMATINTI AVINASH	III	15	PASS
31	15E31A0344	PALNATI SRIKANTH REDDY	III	14	PASS
32	15E31A0346	POLAKA PARDHA SARADHI REDDY	III	18	PASS
33	15E31A0349	SABHAVAT SEVYA	III	15	PASS
34	15E31A0350	SHADMAN ASHRAF	III	16	PASS
35	15E31A0351	SHAIK ABDUL SAIF	III	15	PASS
36	15E31A0352	SHAIK ARIF HUSSAIN	III	16	PASS
37	15E31A0354	SOHAIL MOHAMMED MASOOD AHMED KHAN	III	15	PASS
38	15E31A0356	SYED BAHAUDDIN	III	16	PASS
39	15E31A0360	SYED QAMAR UDDIN RAZA SHAH QUADRI	III	15	PASS
40	15E31A0361	SYED SHAHED AHMED	III	14	PASS
41	15E31A0362	T KULDEEP SINGH	III	18	PASS
42	15E31A0363	TANNEERU RAJA	III	15	PASS
43	15E31A0365	VANGAPALLY SRINIVAS	III	16	PASS
44	16E35A0301	AMAR BIRADAR	III	16	PASS
45	16E35A0302	BHUKYA RAMA	III	15	PASS
46	16E35A0303	DHARAVATH RAVINDER NAYAK	III	14	PASS
47	16E35A0304	EROJI SURESH	III	18	PASS
48	16E35A0305	GOURAV KUMAR JHA	III	15	PASS
49	16E35A0306	KALIKOTA SAI CHARAN	III	16	PASS

Kb
Principal
MAHAVEER
Vysapuri of Mahaveer Institute of Technology
Bandlaguda, Hyd-500 005

Vysapuri, Bandlaguda Post Keshavnagar,
Hyderabad-500 085, Telangana INDIA
Tel: 040-6450979, 20820713, Fax: 040-24435053
E-mail: principal.mahaveer@gmail.com
Website: www.mst.ac.in

MAHAVEER



Approved by AICTE, Affiliated to JNTUHYD

50	16E35A0307	MANYALA SAHJJA	III	15	PASS
51	16E35A0308	TADEMBHARATHI KUMAR	III	16	PASS
52	16E35A0310	TANGILLA ASHOKA VARDHAN RAJU	III	15	PASS
53	14E31A0303	ANSAR AHMED KHAN	III	16	PASS
54	14E31A0334	MOHAMMED ABRAR AHMED	III	15	PASS
55	14E31A0335	MOHAMMED AKIF AHMED	III	14	PASS
56	14E31A0373	G KARTHIK RAJ	III	18	PASS
57	14E31A0374	A KAUSHIK VILAS	III	15	PASS
58	14E31A0386	MOHAMMED SOHAIB	III	16	PASS
59	14E31A0397	SYED SIKANDER ALI	III	15	PASS
60	14E31A0398	SYED VIKAYAT ULLAH	III	16	PASS
61	15E35A0301	E MADHUKAR	III	15	PASS
62	13E31A0304	AKASH HANVETHI	III	16	PASS
63	14E31A0390	RAHUL SINGH	III	15	PASS
64	14E31A0376	IMAMD HASAN KHAN	III	14	PASS
65	14E31A0359	TAMMARASHI AJAY KUMAR	III	18	PASS
66	13E31A0350	S KUNAL	III	15	PASS
67	14E31A0341	MOHD KHAHA MOHIUDDIN	III	16	PASS
68	14E31A0352	SAIFULLAH EKARAN JALKOTE	III	16	PASS
69	14E31A0337	MOHD ADNAN AZHAR	III	15	PASS
70	14E31A0339	MOHD ABDUL HAMEED GOURI	III	14	PASS

K. Sankar
PRINCIPAL
MAHAVEER
INSTITUTE OF SCIENCE & TECHNOLOGY
Bandlaguda, Hyderabad-500 085



CATIA COURSE Summary

- In this course, you will learn how to utilize the core functionality enhancements in Catia.
- First, you will become familiar with using and customizing the new ribbon interface in Catia.
- The new measure and sectioning interfaces will also be examined. Next, you will become familiar with the Sketcher workflow and reference enhancements.
- Part modeling enhancements to features such as Extrude, Corner Chamfer, Sweeps, Blends, and Datum Curves will then be examined.
- You will also learn about new and enhanced Assembly capabilities, such as selecting multiple components, the new relationship constraints, and enhancements for dragging components.
- Then, you will examine the new Table and Balloon functionality for 2-D drawings, and review various detailing enhancements.
- At the end of each module, you will complete a set of review questions to reinforce critical topics from that module. At the end of the course, you will complete a course assessment in Catia intended to evaluate your understanding of the course as a whole.

Copy to :

1. Department of Notice Board
2. Principal for Information
3. Committee Members (Academic)

MAHAVEER
INSTITUTE OF SCIENCE & TECHNOLOGY
Bandlaguda, Hyd-500 005.

Vysapuri, Bandlaguda Post, Keshavnagar,
Hyderabad-500 085, Telangana INDIA
Tel: 040 64598979, 20020773, Fax: 040 24488003
E-mail: principal.mahaveer@gmail.com
Website: www.mist.ac.in

MAHAVEER



Approved by AICTE, Affiliated to JNTUH Hyd

CERTIFICATE OF COURSE COMPLETION

This certificate is presented to T. Raja of
MIST, who has successfully completed technical training course on
"CATIA" held from 02-05-2017 to 12-05-2017 and found the
student performance to be excellent.



ESTD : 2001

Dr. S. Murali
Dr. S. Murali

HOD

Department of Mechanical Engineering

K. Sankar
K. Sankar
Principal
MAHAVEER
INSTITUTE OF SCIENCE & TECHNOLOGY
Bandlaguda, Hyd-500 085.

About the College

As an Institute committed in quality education, MIST aims at providing learning with a Technology-edge. It endeavors to provide consistent training to its students to help them evolve as competent professionals in the highly competitive world. Right from its inception in 2001, it has been tuning itself to meet this objective. A new civilization is emerging in our lives. This civilization belongs with a new way of working. Millions are already tuning their lives to the rhythms of tomorrow.

About Mechanical Dept.

The Mechanical engineering is one of the core engineering departments, which has potential to accommodate all efficient engineers. The Mechanical engineers serve all other branches of engineering directly or indirectly. The Mechanical engineers can find their place in Automobile engineering sector, Steel Plants, Power plants, Software industries, Manufacturing industries, Design industries, Military, Naval and Air force, Defense research organizations, Material research organizations etc.

About the Workshop

The course builds from the big ideas in finite element analysis and computational fluid dynamics to ANSYS case studies that progress from real world applications and examples. ANSYS is the flagship engineering software solution that uses finite element analysis (FEA), which is a numerical and computational method used to solve the real engineering problems related to physics, structural analysis, heat transfer, fluid flow, mass transport, and electromagnetic potential field. To solve the problem, it subdivides a large problem into smaller, simpler parts that are called finite elements and solve the problem by minimizing an associated error function.

Organising committee

CHIEF PATRON

Sri. S. Sudershan Reddy

Chairman

Sri. S. Surendar Reddy

Secretary

Sri S. Dhanunjay Reddy

Joint Secretary

DIRECTOR

Dr. H. S. N. Murthy

PATRON

Dr. S. S. N. Reddy, Principal

CONVENER

Dr. S. Murali,

Professor, Dept. Of Mechanical

PROGRAM COORDINATORS

G. K. Shanmukh Dev

Conducted On

02/05/2017 - 12/05/2017



MAHAVEER
INSTITUTE OF SCIENCE & TECHNOLOGY

Approved by AICTE, Affiliated to JNTU, Hyderabad.
Wazirpur, Bandlaguda, Post: Kothagudi, Hyderabad-500005.

ESTD - 2001



Two week
Certification Course
on

ANSYS

Organized by

Department of Mechanical
Engineering

Vysaguri, Bandlaguda Post, Keshavnagar,
Hyderabad-500 605, Telangana INDIA
Tel: 040-64596979, 22026771, Fax: 040-24455003
E-mail: principal.mahaveer@gmail.com
Website: www.mist.ac.in

MAHAVEER



Approved by AICTE, Affiliated to JNTUHHyd

Date: 01.05.2017

CIRCULAR

Technical Training for IV B. Tech students are starting from 2nd MAY, 2017 onwards. All HODs and Placements coordinators have to manage the trainings and ensure 95% attendance all through the sessions.

All Mentors need to send the compiled feedback report to Dr.S.Murali, HOD at c3hod.mech@gmail.com daily.

Agenda: 1. Introduction to ANSYS.

Design and Development of curriculum for Add on course:

Name of the Faculty : G.K.Shanmukh Dev

PRINCIPAL
MAHAVEER
INSTITUTE OF TECHNOLOGY
BANDLAGUDA, HYD-500 605

Dr.S.Murali

HOD

Department of Mechanical Engineering

Vysapuri, Bandlaguda Post, Keshavnagar,
Hyderabad-500 005, Telangana INDIA
Tel: 040-64556379, 20020773, Fax: 040-24455003
E-mail: principal.mahaaveer@gmail.com,
Website: www.mist.ac.in,

MAHAVEER



Approved by AICTE. Affiliated to JNTUHHyd

Date: 29-04-2017

To
The Principal
MIST,
Hyderabad.

Sub: Proposal for Add-on Course-Reg.

Respected sir,

We are going to conduct 10 days Technical Training for IV B. Tech students on "Introduction to Ansys". We require your approval to go head for proceeding and hope to get an opportunity to serve you the best.

With thanks and regards

PRINCIPAL
Mahaaveer
Institute of Technology & Engineering
Bandlaguda, Hyderabad-500 005

Dr.S.Murali

HOD

Department of Mechanical Engineering



ANSYS SYLLABUS

S.NO	TOPIC COVERED	DURATION (Hours)
1	INTRODUCTION TO FEA AND	3
2	BASIC SOLID MODELING	3
3	ADVANCED SOLID MODELING	3
4	FINITE ELEMENT MODELING (FEM) - I	3
5	FINITE ELEMENT MODELING (FEM) - II	3
6	SOLUTION AND POSTPROCESSOR	3
7	STATIC STRUCTURAL ANALYSIS	3
8	ADVANCED STRUCTURAL ANALYSIS (DYNAMIC AND NONLINEAR)	3
9	ADVANCED STRUCTURAL ANALYSIS	2
10	THERMAL ANALYSIS	2
11	GENERATING THE REPORT OF ANALYSIS	2

PRINCIPAL
MAHAVEER
15/11/2020
Bandlaguda Post Keshavnagar



Department of Mechanical Engineering
ANSYS Technical Training student attendance list 2017-2018

S.NO.	ROLL NO.	NAME OF THE STUDENT	YEAR
1	14E31A0301	ALLI ARAVIND	IV
2	14E31A0302	ANNAPU PUSHPANJALI	IV
3	14E31A0306	B KISHORE	IV
4	14E31A0307	B VISHNU	IV
5	14E31A0308	BALUSA VIVEK	IV
6	14E31A0309	BOTTU SAI MUKUND	IV
7	14E31A0310	C SAI KIRAN	IV
8	14E31A0311	CHINTHIRALA NAGARJUNA	IV
9	14E31A0313	DUDUKA SHIVAKUMAR	IV
10	14E31A0314	DUSA YASHWANTH	IV
11	14E31A0315	EPPA RAGHU	IV
12	14E31A0316	ESUNATHI KALYAN	IV
13	14E31A0317	GANGULA VINAY KUMAR REDDY	IV
14	14E31A0318	GOPHI ABHINAV REDDY	IV
15	14E31A0319	GORIGE RAVIKANTHI	IV
16	14E31A0320	GOWLIKAR BHARGAV KUMAR	IV
17	14E31A0321	JADALA VAMSHI KRISHNA	IV
18	14E31A0322	JITENDRA SINGH	IV
19	14E31A0323	KATAPAAGA NIKHIL KALYAN	IV
20	14E31A0325	KASOJU SAI KIRAN	IV
21	14E31A0326	KATAKAM VINODKUMAR	IV
22	14E31A0327	YAMINI SAI KUMAR	IV

Vysapuri, Bandlaguda Post Keshavnagar,
Hyderabad-500 005, Telangana INDIA
Tel: 040-64596979,20020773, Fax: 040-24455003
E-mail: principal.mahaveer@gmail.com
Website: www.mst.ac.in

MAHAVEER



Approved by AICTE. Affiliated to JNTU-Hyd.

23	14E31A0328	KOTIALA SUSHMITHA	IV
24	14E31A0329	KUCHANPALLY SANTHOSH REDDY	IV
25	14E31A0330	MADDIBOENA SIVAPRAGATHILAKSHMI	IV
26	14E31A0331	MAMMALAKHILESH	IV
27	14E31A0333	MEDI AKHIL	IV
28	14E31A0338	MOHAMMED KHAN	IV
29	14E31A0340	MOHD AJAZ KHAN	IV
30	14E31A0343	MOTHAJGARI VIJAY	IV
31	14E31A0346	MUPPARAM SADHANA	IV
32	14E31A0347	NEELI AKASH	IV
33	14E31A0348	P KRISHNA	IV
34	14E31A0349	PALATI RUKMANGADUDU	IV
35	14E31A0353	SHAIK AQIB	IV
36	14E31A0354	SHAIK MOHAMMED RAYAN	IV
37	14E31A0355	SHAIK SOHAIL	IV
38	14E31A0358	SYED MUZAMEEL ALI	IV
39	14E31A0360	VADLA PRASHANTH	IV
40	14E31A0361	AMIT KUMAR PANDEY	IV
41	14E31A0363	ARROJU SHRAVANKUMAR	IV
42	14E31A0365	BONIMARAJU/SAIKUMAR	IV
43	14E31A0367	FAZAL AHMED KAMIL	IV
44	14E31A0369	G RAGHUVARDHAN REDDY	IV
45	14E31A0372	GORIGE NARENDER	IV
46	14E31A0377	JAMALPUR ADITHYA	IV
47	14E31A0378	KADAVENDI ARAVIND	IV
48	14E31A0380	KOPPULA NARESH REDDY	IV

K. Veer
PRINCIPAL
MAHAVEER
INSTITUTE OF TECHNOLOGY
Vysapuri, Bandlaguda Post, Hyderabad-500 005

Vysapudi, Bandlaguda Post, Keshavnagar,
Hyderabad 500 095, Telangana INDIA
Tel: 040-64556979, 20020773, Fax: 040-24455003
E-mail: principal.mahaveer@gmail.com
Website: www.mahaveer.in

MAHAVEER



Approved by AICTE Affiliated to JNTUHYD

49	14E31A0382	MA RAHMAN	IV
50	14E31A0383	MD MUQTAR AHMED KHAN	IV
51	14E31A0384	MOHAMMED ABDUL RAHMAN	IV
52	14E31A0385	MOHAMMED OMER	IV
53	14E31A0387	MOHAMMED AKBAR	IV
54	14E31A0388	MOHD FAROOQ	IV
55	14E31A0389	MOHD SOHAIL	IV
56	14E31A0391	N VINESH REDDY	IV
57	14E31A0392	NANDIGAM SURENDRA	IV
58	14E31A0393	PITLA SWAMY	IV
59	14E31A0396	RINJU GEORGE	IV
60	14E31A03A0	VADLURI KRISHNA	IV
61	14E31A03A1	YERRA ARVIND REDDY	IV
62	14E31A03A2	SHEOB AHMED	IV
63	14E31A03A3	SYED MD AHMED MOHUDDIN QUADRI	IV
64	13E31A0380	MOHD FARHAN UDDIN	IV
65	15E35A0302	H AKHILESH	IV
66	15E35A0303	HEERIKAR RAHUL	IV
67	15E35A0304	MAMIDIGA NAGESH	IV
68	15E35A0305	MD SHOEB AKRAM	IV
69	15E35A0307	MYAKALA SHIVAKUMAR	IV
70	15E35A0308	SYED ASHFAQ	IV
71	13E31A0318	C VENKATESH	IV

Kishor
MAHAVEER
15/05/2024
Principal Mahaveer



Technical Training Exam on ANSYS Software (A.Y-2017-2018)

2x10=20 Marks

Answer All the Questions

1.

Given the 2D truss structure represented in Figure 1.1, where:

- $h = 5 \text{ m}$
- $L = 5 \text{ m}$
- $F = 1000 \text{ N}$
- $E = 1.0 \times 10^8 \text{ N/m}^2$ (Young's modulus)
- $A = 0.1 \text{ m}^2$ (Cross-section area of each beam element)

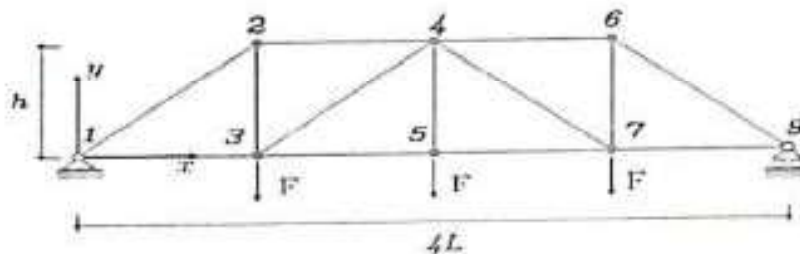

Figure 1.1: Example truss structure, constraints and loads.

2.

- 7.13 Determine the stresses in the plate with the hole subjected to the tensile stress shown in Figure P7-13. Graph the stress variation σ_x versus the distance y from the hole. Let $E = 200 \text{ GPa}$, $\nu = 0.25$, and $t = 25 \text{ mm}$. (Use various mesh densities, depending on your computer program in your finite element model.) Use symmetry as appropriate.



Figure P7-13

MAHAVEER
 Institute of Technology
 Hyderabad-502 003, Telangana, INDIA



Department of Mechanical Engineering					
ANSYS Technical Training student attendance list 2017-2018					
S.NO	Roll No	Name of the student	YEAR	MARKS	PASS/FAIL
1	14E31A0301	ALLI ARAVIND	IV	15	PASS
2	14E31A0302	ANNAPU PUSHIPANJALI	IV	16	PASS
3	14E31A0306	B KISHORE	IV	18	PASS
4	14E31A0307	B VISHNU	IV	15	PASS
5	14E31A0308	BALUSA VIVEK	IV	15	PASS
6	14E31A0309	BOTTU SAI MUKUND	IV	15	PASS
7	14E31A0310	C SAI KIRAN	IV	16	PASS
8	14E31A0311	CHINTHIRALA NAGARJUNA	IV	15	PASS
9	14E31A0313	DUDUKA SHIVAKUMAR	IV	16	PASS
10	14E31A0314	DUSA YASHWANTH	IV	12	PASS
11	14E31A0315	EPPA RAGHU	IV	15	PASS
12	14E31A0316	ESUNATHI KALYAN	IV	16	PASS
13	14E31A0317	GANGULA VINAY KUMAR REDDY	IV	12	PASS
14	14E31A0318	GOPIDI ABHINAV REDDY	IV	15	PASS
15	14E31A0319	GORIGE RAVIKANTH	IV	16	PASS
16	14E31A0320	GOWTIKAR BHARGAV KUMAR	IV	14	PASS
17	14E31A0321	JADALA VAMSHI KRISHNA	IV	15	PASS
18	14E31A0322	JITENDRA SINGH	IV	17	PASS
19	14E31A0323	KATAPAAGA NIKHIL KALYAN	IV	15	PASS
20	14E31A0325	KASOJU SAI KIRAN	IV	16	PASS
21	14E31A0326	KATAKAM VINODKUMAR	IV	16	PASS
22	14E31A0327	YAMINI SAI KUMAR	IV	15	PASS
23	14E31A0328	KOTTALA SUSHIMITHA	IV	16	PASS

Vysapuri, Bandlaguda Post, Keshavnagar,
Hyderabad 500 025, Telangana, INDIA
Tel: 040-64534979, 20020773, Fax: 040-24455003
E-mail: principal.mahaveer@gmail.com
Website: www.mst.ac.in

MAHAVEER



Approved by AICTE - Affiliated to JNTU(H) Hyd

24	14E31A0329	KUCHANPALLY SANTHOSH REDDY	IV	14	PASS
25	14E31A0330	MADDIBOENA SIVAPRAGATHILAKSHMI	IV	15	PASS
26	14E31A0331	MAMMALAKHILESH	IV	15	PASS
27	14E31A0333	MEDI AKHIL	IV	16	PASS
28	14E31A0338	MOHAMMED KHAN	IV	14	PASS
29	14E31A0340	MOHD AJAZ KHAN	IV	15	PASS
30	14E31A0343	MOTHAJIGARI VIJAY	IV	15	PASS
31	14E31A0346	MUPPARAM SADHANA	IV	14	PASS
32	14E31A0347	NEELI AKASHI	IV	16	PASS
33	14E31A0348	P KRISHNA	IV	16	PASS
34	14E31A0349	PALATI RUKMANGADUDU	IV	14	PASS
35	14E31A0353	SHAIK AQIB	IV	15	PASS
36	14E31A0354	SHAIK MOHAMMED RAYAN	IV	16	PASS
37	14E31A0355	SHAIK SOHAIL	IV	15	PASS
38	14E31A0358	SYED MUZAMEEL ALI	IV	16	PASS
39	14E31A0360	VADLA PRASHANTH	IV	14	PASS
40	14E31A0361	AMIT KUMAR PANDY	IV	12	PASS
41	14E31A0363	ARROJU SHRAVANKUNAR	IV	15	PASS
42	14E31A0365	BOMMARAJU SAIKUMAR	IV	16	PASS
43	14E31A0367	FAZAL AHMED KAMIL	IV	15	PASS
44	14E31A0369	G RAGHUVERDIHAN REDDY	IV	16	PASS
45	14E31A0372	GORIGE NARENDER	IV	15	PASS
46	14E31A0377	JAMALPUR ADITHYA	IV	14	PASS
47	14E31A0378	KADAVENDI ARAVIND	IV	18	PASS
48	14E31A0380	KOPPULA NARESH REDDY	IV	15	PASS

Kishu

VEER

11/11/2014

Principal Mahaveer Institute of Technology

Vysapam, Bandlaguda Post, Keshavnagar,
Hyderabad-500 005, Telangana INDIA
Tel: 040-64516919, 28020773, Fax: 040-24451003
E-mail: principal.mahaveer@gmail.com
Website: www.mist.ac.in

MAHAVEER



Approved by AICTE. Affiliated to JNTU(H) Hyd

49	14E31A0382	MA RAHEMAN	IV	16	PASS
50	14E31A0383	MD MUQTAR AHMED KHAN	IV	15	PASS
51	14E31A0384	MOHAMMED ABDUL RAHEMAN	IV	16	PASS
52	14E31A0385	MOHAMMED OMER	IV	15	PASS
53	14E31A0387	MOHAMMED AKBAR	IV	16	PASS
54	14E31A0388	MOHD FAROOQ	IV	14	PASS
55	14E31A0389	MOHD SOHAIL	IV	12	PASS
56	14E31A0391	N VINESH REDDY	IV	15	PASS
57	14E31A0392	NANDIGAM SURENDRA	IV	16	PASS
58	14E31A0393	PITLA SWAMY	IV	15	PASS
59	14E31A0396	RINJU GEORGE	IV	16	PASS
60	14E31A03A0	VADLURI KRISHNA	IV	15	PASS
61	14E31A03A1	YERRA ARVIND REDDY	IV	14	PASS
62	14E31A03A2	SHEOB AHMED	IV	18	PASS
63	14E31A03A3	SYED MD AHMED MOHIUDDIN QUADRI	IV	15	PASS
64	13E31A0380	MOHD FARHAN UDDIN	IV	16	PASS
65	15E35A0302	H AKHILESH	IV	15	PASS
66	15E35A0303	HIRIKAR RAHUL	IV	15	PASS
67	15E35A0304	MAMIDIGA NAGESH	IV	16	PASS
68	15E35A0305	MD SHOEB AKRAM	IV	18	PASS
69	15E35A0307	MYAKALA SHIVAKUMAR	IV	17	PASS
70	15E35A0308	SYED ASHFAQ	IV	16	PASS
71	13E31A0318	C VENKATESH	IV	17	PASS

[Handwritten Signature]
PRINCIPAL
MAHAVEER
INSTITUTE OF TECHNOLOGY
BANDLAGUDA POST, KESHAVNAGAR
HYDERABAD - 500 005



ANSYS COURSE Summary

Department of Mechanical Engineering

1. The Geometry preparation training course is for users who want to create and modify geometry in preparation for CFD or FEA analysis. The training will be focused in either ANSYS Design Modeler or ANSYS Space Claim.
2. The ANSYS Meshing training course will give you the tools for generating good quality meshes for Fluent and CFX. The trainee will choose which tool should be used: ANSYS Meshing, Fluent Meshing or ICEM CFD.
3. This course will show how to set up a range of simulation types in the ANSYS Fluent or ANSYS CFX solver, as well as how to post process the results by using our CFD Post Tool.
4. This course will show how to set up a range of simulation types in ANSYS Mechanical, as well as how to post process and evaluate your results.
5. To acquire advance knowledge to perform explicit simulations with ANSYS Explicit STR, ANSYS AUTODYN or ANSYS LS-DYNA.
6. This is an introductory to intermediate level training for using ANSYS HFSS for all applications, like RF/microwave, antennas or planar problems. Participants will get understanding of HFSS modeling, solution process and post-processing features, which can be used for other advanced applications. The course will also cover advanced topics like dynamic link between EM and circuit, impedance matching, overview of HFSS 3D layout interface and speeding-up HFSS simulation using HPC.
7. Provide the needed tools for the complete simulation of a pressure Vessel from scratch. Several types of analysis and boundary conditions will be discussed, by using pressure vessels examples.
8. To acquire advance knowledge for performing mechanical simulation in Fixed Offshore Structures.

Copy to :

1. Department of Notice Board
2. Principal for Information
3. Committee Members (Academic)

Kannur, Malappuram District, Kerala
P.O. Box No. 400001, Kannur-690001
Tel: 944-4100001, 200001, Fax: 049-2455002
E-mail: gannur@mist.ac.in, gannur@mist.ac.in
Website: www.mist.ac.in

MAHAVEER



Approved by AICTE, Government of India

CERTIFICATE OF COURSE COMPLETION

This certificate is presented to C. Venkatesh of
MIST, who has successfully completed technical training course on
"ANSYS" held from 02-05-2017 to 12-05-2017 and found the
student performance to be excellent.

K. Anil
PRINCIPAL
MAHAVEER
INSTITUTE OF SCIENCE AND TECHNOLOGY
KANNUR, PIN-690001, KERALA



ESTD : 2001

D. S. Anand
HOD

Department of Mechanical Engineering

Syambur, Mandharauda, Post Kanchanur,
Hyderabad-500 006, Telangana, India
Tel: 040-64580076, 200-20723 Fax: 040-6458003
E-mail: principal.mahaveer@mahaveer.edu
Website: www.mahaveer.edu



DEPARTMENT OF MECHANICAL ENGINEERING

List of students enrolled in ANSYS (2017-2018)

S.No	Roll No	Name of the student	25/17	2/15	4/15	5/15	6/15	8/15	9/15	10/15	11/15	12/15
1	14E31A0301	ALLI ARAVIND	P	P	P	P	P	P	P	P	P	P
2	14E31A0302	ANNAPU PUSHPANJALI	P	P	P	P	P	P	P	P	P	P
3	14E31A0306	B KISHORE	P	P	P	P	P	P	P	P	P	P
4	14E31A0307	B VISHNU	P	P	P	P	P	P	P	P	P	P
5	14E31A0308	BALUSA VIVEK	P	P	P	P	P	P	P	P	P	P
6	14E31A0309	BOTTU SAI MUKUND	P	P	P	P	P	P	P	P	P	P
7	14E31A0310	C SAI KIRAN	P	P	P	P	P	P	P	P	P	P
8	14E31A0311	CHENTHIRALAN ARJUNA	P	P	P	P	P	P	P	P	P	P
9	14E31A0313	DUDUKA SHIVAKUMAR	P	P	P	P	P	P	P	P	P	P
10	14E31A0314	DUSA YASHWANATH	P	P	P	P	P	P	P	P	P	P
11	14E31A0315	EPPA RAGHU	P	P	P	P	P	P	P	P	P	P
12	14E31A0316	ESUNATHI KALYAN	P	P	P	P	P	P	P	P	P	P

W

Vysapuri, Bandlaguda Post:Keshavgiri,

Hyderabad-500 005, TELANGANA INDIA

Tel: 040-64596979,8978380692 Fax: 040-24455003

E-mail: e3hod.it@gmail.com,

Website: www.mist.ac.in,

MAHAVEER

INSTITUTE OF SCIENCE & TECHNOLOGY

Approved by AICTE, Affiliated to JNTUH,Hyd.



DEPARTMENT OF ELECTRONICS AND COMMUNICATION ENGINEERING

Date: 04-09-2017

CIRCULAR

Technical Trainings on C programming is starting from 22-09-2017 onwards. All the students II year ,B.Tech I Semester should attend.

Design and development of curriculum for add-on courses :

Faculty Names: 1.Dr. Jaspal Kumar

2.Mr.R. Prabhakar

3. Mr. D. Laxmi Narayana

HOD, ECE

Cc: Principal for information
= Coordinator to inform the students
= Notice board & department File.

PRINCIPAL
MAHAVEER
INSTITUTE OF SCIENCE & TECHNOLOGY
Bandlaguda, Hyd-500 005.

Vysapuri, Bandlaguda Post, Keshavgi, Hyderabad-500 005, TELANGANA INDIA

MAHAVEER

INSTITUTE OF SCIENCE & TECHNOLOGY

Approved by AICTE; Affiliated to JNTUH, Hyd.



Hyderabad-500 005, TELANGANA INDIA
Tel: 040-64596979, 8978380692 Fax: 040-24455003
E-mail: sjhod.it@gmail.com,
Website: www.mist.ac.in

DEPARTMENT OF ELECTRONICS AND COMMUNICATION ENGINEERING

SYLLABUS FOR Training - C programming

SNO	TOPIC COVERED	DURATION
1	Introduction to Principles of programming	3
2	Introduction to C Programming	3
3	Operators and Expressions	3
4	Data Types and Input/Output Operators	3
5	Control Statements and Decision Making	3
6	Arrays and Strings	3
7	Pointers	3
8	Structures and Unions	3
9	Functions	3
10	Storage Classes	3
11	The Preprocessor	3
12	Dynamic Memory Allocation	3
13	File Management	3

HOD-ECE

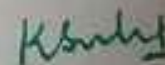

PRINCIPAL
MAHAVEER
INSTITUTE OF SCIENCE & TECHNOLOGY
Bandlaguda, Hyd-500 005.

Vysapuri, Bandlaguda Post:Keshavgiri,

Hyderabad-500 005, TELANGANA INDIA
Tel: 040-64596979,8979380692,Fax: 040-24455003
E-mail: a3hod.it@gmail.com
Website: www.mist.ac.in,

MAHAVEER

INSTITUTE OF SCIENCE & TECHNOLOGY

Approved by AICTE. Affiliated to JNTUH,Hyd.



DEPARTMENT OF ELECTRONICS AND COMMUNICATION ENGINEERING

LIST OF REGISTERED STUDENTS FOR Training - C programming

S.NO	H.T. NO.	NAME OF STUDENT
1	16E31A0401	A DARCYNA KESHAYA
2	16E31A0402	AENUGULA SWATHI
3	16E31A0403	ANAGOUNI SHIVANIGUDD
4	16E31A0405	ABHILA GANESH
5	16E31A0406	AVVARI BHARGAVI
6	16E31A0407	B NAVYA SRI
7	16E31A0408	BADAMSAI SHANKER
8	16E31A0410	BYREDOV SRIDEVI
9	16E31A0413	DESHAM PREETHIKA
10	16E31A0415	DHARAVATHI THARUN
11	16E31A0416	ENJAMURI PAVAN SAI PREETAM
12	16E31A0418	G HARISH
13	16E31A0420	HASBI SHRUTHI
14	16E31A0421	JAGIDI VAMSHUKRISHNA
15	16E31A0422	KAKUSTAMEPAVANI
16	16E31A0423	KALWA HARICA
17	16E31A0426	KONAPARTHY ANJA CHARY
18	16E31A0427	KOTTALA VIKRAM
19	16E31A0428	KOYADA SWARNALATHA
20	16E31A0429	KUTKARNI MANOJ
21	16E31A0430	LAGISHETTY ADITHYA
22	16E31A0433	MOHAMMAD AMEER KHAN
23	16E31A0435	PAKTEER GANESH
24	16E31A0436	PANYALA NAVYASREE
25	16E31A0437	PARIDULA SHIVA TEJA
26	16E31A0438	PETA SAI TEJA
27	16E31A0439	POKURI SHEKAR
28	16E31A0440	PRAVALIKA GADDAM
29	16E31A0442	RAPELLI HARIKA
30	16E31A0443	SHAIK RASHEEDA BEGUM

K. Srinivas

PRINCIPAL
MAHAVEER
INSTITUTE OF SCIENCE & TECHNOLOGY
Bandlaguda, Hyd-500 005

Vysapuri, Bandlaguda Post: Keshavgi,ri,

Hyderabad-500 005, TELANGANA INDIA
Tel: 040-64596979,8978380692, Fax: 040-24455003
E-mail: e3hod_it@gmail.com,
Website: www.mist.ac.in,

MAHAVEER

INSTITUTE OF SCIENCE & TECHNOLOGY

Approved by AICTE, Affiliated to JNTUH,Hyd.



DEPARTMENT OF ELECTRONICS AND COMMUNICATION ENGINEERING

31	16E31A0456	ABHILASH REDDY KODIGANTI	17	23
32	16E31A0457	AERUKALA SAI CHITRA	18	22
33	16E31A0459	ANANTHOLU SHIVANI	18	25
34	16E31A0460	ANKAM SRIVARSHA	20	28
35	16E31A0461	ANNABOINA SHALINI	17	23
36	16E31A0462	ANNAM SRAVAN	20	29
37	16E31A0463	ANUGONDA KIRAN KUMAR REDDY	18	23
38	16E31A0464	ANUMOLU NARENDRA SAI	20	20
39	16E31A0465	B PRADEEP	18	27
40	16E31A0466	BATTA SREE AMRUTH VAMSHI	17	24
41	16E31A0467	BIJJALA SHRAVANI	18	21
42	16E31A0468	BODDUPALLI VAMSHIKRISHNA	20	25
43	16E31A0469	CH.SUSHMITHA	20	25
43	16E31A0470	CHALLA VARUN REDDY	20	20
44	16E31A0471	CHEKKALA GANESH	20	21
45	16E31A0472	CHILUKA HARISH	18	18
46	16E31A0474	CHITTEPU PREMALATHA	19	21
47	16E31A0475	CHOLLETI KAVYA	20	23
48	16E31A0476	ELAGANDHALA VAMSHI PRANAY	19	22
49	16E31A0477	ELLENDULA VARSHITH	20	25
50	16E31A0479	GANGREDDY MAHENDER	18	28

Keshavgi,ri

PRINCIPAL
MAHAVEER
INSTITUTE OF SCIENCE & TECHNOLOGY
Bandlaguda, Hyd-500 005.

Vysapuri, Bandlaguda Post:Keshavgiri,

Hyderabad-500 005, TELANGANA INDIA
Tel: 040-64596979,8978380692 Fax: 040-24455003
E-mail: e3hod.it@gmail.com,
Website: www.mist.ac.in

MAHAVEER

INSTITUTE OF SCIENCE & TECHNOLOGY

Approved by AICTE, Affiliated to JNTUH,Hyd



DEPARTMENT OF ELECTRONICS AND COMMUNICATION ENGINEERING

Training - C programming QUESTION PAPER

Duration: 120 Minutes

10 X 3 = 30 Marks

Answer the following all questions. Each question carries 2 marks.

1. Distinguish between malloc() & calloc() memory allocation.
2. Explain the syntax for for loop.
3. What is recursion?
4. What is typecasting?
5. What are command line arguments?
6. What is a preprocessor?
7. What is a self-referential structure?
8. What is the difference between actual and formal parameters?
9. What is the purpose of the keyword typedef?
10. What are storage classes?

HOD-ECE

PRINCIPAL
MAHAVEER
INSTITUTE OF SCIENCE & TECHNOLOGY
Bandlaguda, Hyd-500 005.

Vysapuri, Bandlaguda Post:Keshavgi,

MAHAVEER

INSTITUTE OF SCIENCE & TECHNOLOGY

Approved by AICTE, Affiliated to JNTUH,Hyd.



Hyderabad-500 005, TELANGANA INDIA
Tel: 040-84596979,8978380692,Fax: 040-24455003
E-mail: a3hod.it@gmail.com,
Website: www.mist.ac.in,

DEPARTMENT OF ELECTRONICS AND COMMUNICATION ENGINEERING

STUDENTS ATTENDANCE AND RESULT SHEET FOR Training - C programming

S.NO	R.T. NO.	NAME OF STUDENT	ATTENDACE 20)HRS	MARKS OBTAINED(30)
1	16E31A0401	ADARSHNA AKSHAYA	17	27
2	16E31A0402	AENUGULA SWATHI	18	24
3	16E31A0403	ANAGUNI SIVANI GEUD	18	14
4	16E31A0405	ASHALA GANESH	20	25
5	16E31A0406	AVVARI BHARGAVI	17	25
6	16E31A0407	B NAVYA SRI	20	15
7	16E31A0408	BADAM SAI SHANKER	17	14
8	16E31A0410	HYREDDY SRIDEVI	20	22
9	16E31A0413	DESHAM PREETIKA	20	28
10	16E31A0415	DJALARAYATH THARUN	20	ABSENT
11	16E31A0416	ENJAMURI PAVAN SAI PREETAM	17	26
12	16E31A0418	G HARISH	18	12
13	16E31A0420	HASBI SIRUTHI	18	22
14	16E31A0421	JAGIDI VAMSHIKRISHNA	20	23
15	16E31A0422	KAKUSTANI PAVANI	17	22
16	16E31A0423	KALWA HARIKA	20	25
17	16E31A0426	KONAPAKSHI ANEA CHARY	18	28
18	16E31A0427	KOTTALA VIKRAM	20	23
19	16E31A0428	KOVADA SWARNALATHA	19	29
20	16E31A0429	KULKARNI MANOJ	17	23
21	16E31A0430	LADISHETTY ADITHYA	18	20
22	16E31A0433	MOHAMMAD AMEER KHAN	20	27
23	16E31A0435	PAKIBER GANESH	29	24
24	16E31A0436	PANYALA NAVYASREE	20	21
25	16E31A0437	PARIDULA SHIVA TEJA	20	25
26	16E31A0438	PETA SAI TEJA	18	25
27	16E31A0439	POKURU SHEKAR	19	20
28	16E31A0440	PRAVALIKA GAJIDAM	20	21
29	16E31A0442	RAPELI HARIKA	18	21
30	16E31A0443	SHAIK RASHEEDA BEGUM	20	22

K. Subh
PRINCIPAL
MAHAVEER
INSTITUTE OF SCIENCE & TECHNOLOGY
Bandlaguda, Hyd-500 005

Vysapuri, Bandlaguda Post:Keshavgiri,

Hyderabad-500 005, TELANGANA INDIA
Tel: 040-64596979,8978380692 Fax: 040-24455003
E-mail: e3hod.it@gmail.com,
Website: www.mist.ac.in.

MAHAVEER

INSTITUTE OF SCIENCE & TECHNOLOGY

Approved by AICTE, Affiliated to JNTUH,Hyd



DEPARTMENT OF ELECTRONICS AND COMMUNICATION ENGINEERING

31	19E31A0456	ABHILASH REDDY KODIGANTI	17	25
32	19E31A0457	AERUKALA SAI CHITRA	18	22
33	19E31A0459	ANANTHOJU SHIVANI	18	25
34	19E31A0460	ANKAM SRIVARSHA	20	28
35	19E31A0461	ANNABOINA SHALINI	17	23
36	19E31A0462	ANNAM BRAVAN	20	29
37	19E31A0463	ANUGONDA KIRAN KUMAR REDDY	18	23
38	19E31A0464	ANUMOLU NARENDRA SAI	20	20
39	19E31A0465	B PRADEEP	19	27
40	19E31A0466	BATTA SREE AMRUTH VAMSHI	17	24
41	19E31A0467	BIJJALA SHRAVANI	18	21
42	19E31A0468	BODDUPALLI VAMSHIKRISHNA	20	25
43	19E31A0469	CH SUSHMITHA	20	25
43	19E31A0470	CHALLA VARUN REDDY	20	20
44	19E31A0471	CHEKKALA GANESH	20	21
45	19E31A0472	CHILUKA HARISH	19	23
46	19E31A0474	CHITTEPU PREMALATHA	19	22
47	19E31A0475	CHOLLETI KAVYA	20	23
48	19E31A0476	ELAGANDHALA VAMSHI PRANAY	19	22
49	19E31A0477	ELLENDULA VARSHITH	20	25
50	19E31A0479	GANGIREDDY MAHENDER	18	28

K. Srinivas
PRINCIPAL
MAHAVEER
INSTITUTE OF SCIENCE & TECHNOLOGY
Bandlaguda, Hyd-500 005.

Vysapuri, Bandlaguda Post, Keshavgi,ri,

Hyderabad-500 005, TELANGANA INDIA

Tel: 040-64596979, 8978380692 Fax: 040-24455003

E-mail: a3hod.it@gmail.com

Website: www.mist.ac.in

MAHAVEER

INSTITUTE OF SCIENCE & TECHNOLOGY

Approved by AICTE, Affiliated to JNTUH, Hyd.



DEPARTMENT OF ELECTRONICS AND COMMUNICATION ENGINEERING

SUMMARY REPORT OF Training - C programming

C is robust language and has rich set of built-in functions, data types and operators which can be used to write any complex program.

Program written in C are efficient due to availability of several data types and operators.

C is good choice for system-level programming. Nevertheless, it is not perfect for all programmers and all situations.

C pointers are a common source of confusion and programming errors.

C also lacks explicit support for useful abstractions such as classes and objects.

That may be a reason C is not preferable language for application-level programming. Newer languages such as C++ and Java address these issues for application-level programs.

C programming language is not limited to but used widely in operating systems, language compilers, network drivers, language interpreters, and system utilities areas of development.

COORDINATOR

Copy to:

1. Department Notice Board
2. Principal for Information
3. Committee Members (Academic)

PRINCIPAL
MAHAVEER
INSTITUTE OF SCIENCE & TECHNOLOGY
Bandlaguda, Hyd-500 005

Attendance sheet for Training - C programming registered students:

Sno	Roll Ticket No.	Name of the Candidate	1	2	3	4	5	6	7	8	9	10	11	12	13	14	15	16	17	18	19	20	ATTENDANCE SHEET
1	16E31A001	ADARSH AKSHAYA	1	2	3	4	5	6	7	8	9	10	11	12	13	14	15	16	17	18	19	20	17
2	16E31A002	ADARSH SWATHI	1	2	3	4	5	6	7	8	9	10	11	12	13	14	15	16	17	18	19	20	18
3	16E31A003	ANAGUN SHIVANU GOUD	1	2	3	4	5	6	7	8	9	10	11	12	13	14	15	16	17	18	19	20	18
4	16E31A005	ASHA GANESH	1	2	3	4	5	6	7	8	9	10	11	12	13	14	15	16	17	18	19	20	20
5	16E31A006	AVVARI BHARGAVI	1	2	3	4	5	6	7	8	9	10	11	12	13	14	15	16	17	18	19	20	17
6	16E31A007	B NAVYA SRI	1	2	3	4	5	6	7	8	9	10	11	12	13	14	15	16	17	18	19	20	20
7	16E31A009	BADDAM SAI SHANKAR	1	2	3	4	5	6	7	8	9	10	11	12	13	14	15	16	17	18	19	20	20
8	16E31A010	BYREDDY SRIDEVI	1	2	3	4	5	6	7	8	9	10	11	12	13	14	15	16	17	18	19	20	20
9	16E31A011	DESDAM PREETIKA	1	2	3	4	5	6	7	8	9	10	11	12	13	14	15	16	17	18	19	20	20
10	16E31A013	DHARAVATHI THARUN	1	2	3	4	5	6	7	8	9	10	11	12	13	14	15	16	17	18	19	20	17
11	16E31A015	PREETAM	1	2	3	4	5	6	7	8	9	10	11	12	13	14	15	16	17	18	19	20	18
12	16E31A018	G HARISH	1	2	3	4	5	6	7	8	9	10	11	12	13	14	15	16	17	18	19	20	18
13	16E31A020	GADHI SRUTHI	1	2	3	4	5	6	7	8	9	10	11	12	13	14	15	16	17	18	19	20	20
14	16E31A021	GADRI VAMSIKRISHNA	1	2	3	4	5	6	7	8	9	10	11	12	13	14	15	16	17	18	19	20	17
15	16E31A022	KAKUKAM PAVANI	1	2	3	4	5	6	7	8	9	10	11	12	13	14	15	16	17	18	19	20	17
16	16E31A023	KATWA HARSHA	1	2	3	4	5	6	7	8	9	10	11	12	13	14	15	16	17	18	19	20	20
17	16E31A026	KONAPARTHY ANJACHERRY	1	2	3	4	5	6	7	8	9	10	11	12	13	14	15	16	17	18	19	20	18
18	16E31A027	KOTTALA VIKRAM	1	2	3	4	5	6	7	8	9	10	11	12	13	14	15	16	17	18	19	20	20
19	16E31A028	KOVADA SWARNALATHA	1	2	3	4	5	6	7	8	9	10	11	12	13	14	15	16	17	18	19	20	19
20	16E31A029	KULSARMI MANOJ	1	2	3	4	5	6	7	8	9	10	11	12	13	14	15	16	17	18	19	20	17
21	16E31A030	LAGISSRETTY ADITHYAN	1	2	3	4	5	6	7	8	9	10	11	12	13	14	15	16	17	18	19	20	18
22	16E31A033	MOHAMMAD AMBER KHAN	1	2	3	4	5	6	7	8	9	10	11	12	13	14	15	16	17	18	19	20	20
23	16E31A035	PAKUR GANESH	1	2	3	4	5	6	7	8	9	10	11	12	13	14	15	16	17	18	19	20	19
24	16E31A036	PASUALA NAVYASREI	1	2	3	4	5	6	7	8	9	10	11	12	13	14	15	16	17	18	19	20	20
25	16E31A037	PAREDEKA SHIVANU	1	2	3	4	5	6	7	8	9	10	11	12	13	14	15	16	17	18	19	20	20
26	16E31A038	PEA SAI TEJA	1	2	3	4	5	6	7	8	9	10	11	12	13	14	15	16	17	18	19	20	18
27	16E31A039	POKURI SHEKAR	1	2	3	4	5	6	7	8	9	10	11	12	13	14	15	16	17	18	19	20	18
28	16E31A040	PRAVALIKA GADDAM	1	2	3	4	5	6	7	8	9	10	11	12	13	14	15	16	17	18	19	20	20
29	16E31A042	RAPPELLI HARISH	1	2	3	4	5	6	7	8	9	10	11	12	13	14	15	16	17	18	19	20	18
30	16E31A043	SUNUK RGSHEEDA BEGUM	1	2	3	4	5	6	7	8	9	10	11	12	13	14	15	16	17	18	19	20	20

MAHA VEETI
 INSTITUTE OF SCIENCE & TECHNOLOGY
 Basundara, Hyd-500 085

31	1BE31A0456	ABHILASH REDDY KODDAMATI	1	9	3	4	5	6	7	8	9	10	11	12	13	14	15	16	17
32	1BE31A0457	AERUKALA SAI CHITRA	1	3	3	4	5	6	7	8	9	10	11	12	13	14	15	16	17
33	1BE31A0458	ANANTHOU SHIVANI	1	2	3	4	5	6	7	8	9	10	11	12	13	14	15	16	17
34	1BE31A0460	ANNAI SRIVANSHI	1	3	3	4	5	6	7	8	9	10	11	12	13	14	15	16	17
35	1BE31A0461	ANNASOMA SHALINI	1	2	3	4	5	6	7	8	9	10	11	12	13	14	15	16	17
36	1BE31A0462	ANNAI SRIVAN	1	2	3	4	5	6	7	8	9	10	11	12	13	14	15	16	17
37	1BE31A0463	REDDY	1	2	3	4	5	6	7	8	9	10	11	12	13	14	15	16	17
38	1BE31A0464	ANUMKOLU NARENDRA SHI	1	2	3	4	5	6	7	8	9	10	11	12	13	14	15	16	17
39	1BE31A0465	B PRADEEP	1	2	3	4	5	6	7	8	9	10	11	12	13	14	15	16	17
40	1BE31A0466	BATTA SREE AMRUTH VAMSHI	1	2	3	4	5	6	7	8	9	10	11	12	13	14	15	16	17
41	1BE31A0467	BIJALA SHIVANI	1	2	3	4	5	6	7	8	9	10	11	12	13	14	15	16	17
42	1BE31A0468	BODDUPALLI VAMSHIKRISHNA	1	2	3	4	5	6	7	8	9	10	11	12	13	14	15	16	17
43	1BE31A0469	OH SUSHRITHA	1	2	3	4	5	6	7	8	9	10	11	12	13	14	15	16	17
44	1BE31A0470	CHALLA VARUN REEDY	1	2	3	4	5	6	7	8	9	10	11	12	13	14	15	16	17
45	1BE31A0471	CHEKKALA GANESH	1	2	3	4	5	6	7	8	9	10	11	12	13	14	15	16	17
46	1BE31A0472	CHILUKA HARISH	1	2	3	4	5	6	7	8	9	10	11	12	13	14	15	16	17
47	1BE31A0474	CHITTEPU PREMALATHA	1	2	3	4	5	6	7	8	9	10	11	12	13	14	15	16	17
48	1BE31A0475	CHOLLETTIRAVYA	1	2	3	4	5	6	7	8	9	10	11	12	13	14	15	16	17
49	1BE31A0476	PRANAY	1	2	3	4	5	6	7	8	9	10	11	12	13	14	15	16	17
50	1BE31A0477	ELLENDULA VARSHETH	1	2	3	4	5	6	7	8	9	10	11	12	13	14	15	16	17
51	1BE31A0479	GANGIREDDY MAHADEER	1	2	3	4	5	6	7	8	9	10	11	12	13	14	15	16	17

[Signature]
Co-ordinator

[Signature]
HOD, ECE Dept

[Signature]

PRINCIPAL
MAHAVEER
INSTITUTE OF SCIENCES & TECHNOLOGY
Banwalinguda, Hyd-500 065.

Vysapuri, Bandlaguda Post:Keshavgiri,

Hyderabad-500 005, TELANGANA INDIA
Tel: 040-64596979,8978380692 Fax: 040-24455003
E-mail: e3hod.it@gmail.com,
Website: www.mist.ac.in,

MAHAVEER

INSTITUTE OF SCIENCE & TECHNOLOGY

Approved by AICTE, Affiliated to JNTUH,Hyd.



DEPARTMENT OF ELECTRONICS AND COMMUNICATION ENGINEERING

Date: 01-02-2018

CIRCULAR

Technical Trainings on Java Certification programme is starting from 22-12-2018 onwards.

All the students II year ,B.Tech II Semester should attend.

Design and development of curriculum for add-on courses :

Faculty Names: 1.Dr. Jaspal Kumar
2.Dr. M. Sandhya Rani
3. Dr. V.G. Supriya

HOD, ECE

Cc: Principal for information
Coordinator to inform the students
Notice board & department File.



PRINCIPAL
MAHAVEER
INSTITUTE OF SCIENCE & TECHNOLOGY
Bandlaguda, Hyd-500 005.

Vysapuri, Bandlaguda Post:Koshavgirl.

MAHAVEER

INSTITUTE OF SCIENCE & TECHNOLOGY

Approved by AICTE, Affiliated to JNTUH,Hyd.



Hyderabad-500 005, TELANGANA INDIA
Tel: 040-64596979,8978380692, Fax: 040-24456003
E-mail: e3hod.it@gmail.com,
Website: www.mist.ac.in,

DEPARTMENT OF ELECTRONICS AND COMMUNICATION ENGINEERING

Date: 01-02-2018

SYLLABUS FOR Java Certification programme

SNO	TOPIC COVERED	DURATION
1	Introduction	3
2	OOPS (Object Oriented Programming & Systems)	3
3	STRING Manipulation	3
4	Array	3
5	Packages	3
6	Exception Handling	3
7	I/O Streams	3
8	Multithreading	3
9	Wrapper Classes	3
10	Inner Classes	3
11	Collection Frame Work	3
12	AWT	3
13	SWING (JFC)	3

HOD-ECE

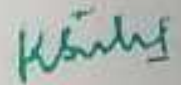

PRINCIPAL
MAHAVEER
INSTITUTE OF SCIENCE & TECHNOLOGY
Bandlaguda, Hyd-500 005.

Vysapuri, Bandlaguda Post:Keshavgiri,

Hyderabad-500 005, TELANGANA INDIA
Tel: 040-64596979,8978380692.Fax: 040-24455003
E-mail: e3hod.it@gmail.com,
Website: www.mist.ac.in,

MAHAVEER

INSTITUTE OF SCIENCE & TECHNOLOGY

Approved by AICTE. Affiliated to JNTUH,Hyd.



DEPARTMENT OF ELECTRONICS AND COMMUNICATION ENGINEERING

LIST OF REGISTERED STUDENTS FOR Java Certification programme

S NO	H.T. NO.	NAME OF STUDENT
1	16E31A0401	ADABOINA AKSHAYA
2	16E31A0402	ADWOLELA SWATI
3	16E31A0403	ANAGOUNESHVIYANI GOUD
4	16E31A0405	ASTHALA GANESH
5	16E31A0406	AYYARI BHARGAVI
6	16E31A0407	B NAVYA SRU
7	16E31A0408	BADAM SAI SHANKER
8	16E31A0410	BYREDDY SRIDEVI
9	16E31A0413	DESHAM PREETHIKA
10	16E31A0415	DHARAVATH THARUN
11	16E31A0418	ENJAMURI PAVAN SAI PREETAM
12	16E31A0418	G HARISH
13	16E31A0420	HASBI SHRUTHI
14	16E31A0421	JAGIDI VAMSIKRISHNA
15	16E31A0422	KAKUSTAM PAVANI
16	16E31A0423	KALWA HARIKA
17	16E31A0426	KONAPARTHY ANJA CHARY
18	16E31A0427	KOTTALA VIJRAM
19	16E31A0428	KOYATA SWARNALATHA
20	16E31A0429	KULKARNI MANOJ
21	16E31A0430	LAGISHETTY ADITHYA
22	16E31A0433	MOHAMMAD AMEER KHAN
23	16E31A0435	PAKETR GANESH
24	16E31A0436	PANYALA NAVYASREE
25	16E31A0437	PARIDULA SHIVA TEJA
26	16E31A0438	PETA SAI TEJA
27	16E31A0439	POKURI SHEKAR
28	16E31A0440	PRAVALIKA GADDAM
29	16E31A0442	RAPELLI HARIKA
30	16E31A0443	SHAIK RASHEEDA BEGUM

K. Srinivas

PRINCIPAL
MAHAVEER
INSTITUTE OF SCIENCE & TECHNOLOGY
Bandlaguda, Hyd-500 005

Vysapuri, Bandlaguda Post:Keshavgiri,

Hyderabad-500 005, TELANGANA INDIA
Tel: 040-64596979,8978380692,Fax: 040-24455003
E-mail: eshod.it@gmail.com,
Website: www.mist.ac.in,

MAHAVEER

INSTITUTE OF SCIENCE & TECHNOLOGY

Approved by AICTE, Affiliated to JNTUH,Hyd.



DEPARTMENT OF ELECTRONICS AND COMMUNICATION ENGINEERING

31	16E31A0466	ASHILASH REDDY KODIGANTI
32	16E31A0467	AERUKALA SAI CHITRA
33	16E31A0468	ANANTHOJU SHIVANI
34	16E31A0469	ANKAM SRIVARSHA
35	16E31A0470	ANNABONA SHALINI
36	16E31A0471	ANNAM BRAVAN
37	16E31A0472	ANUGONDA KIRAN KUMAR REDDY
38	16E31A0473	ANUMOLU NARENDRA SAI
39	16E31A0474	B PRADEEP
40	16E31A0475	BATTA SREE AMRUTH VAMSHI
41	16E31A0476	BUJALA SHRAVANI
42	16E31A0477	BODDUPALLI VAMSHIKRISHNA
43	16E31A0478	CH BUSHMITHA
44	16E31A0479	CHALLA VARUN REDDY
45	16E31A0480	CHEKKALA GANESH
46	16E31A0481	CHILUKA HARISH
47	16E31A0482	CHITTEPU PREMALATHA
48	16E31A0483	CHOLLETI KAVYA
49	16E31A0484	ELAGANDHALA VAMSHI PRANAY
49	16E31A0477	ELLENDULA VARSHITH
50	16E31A0479	GANGIREDDY MAHENDER

K. Srinivas

PRINCIPAL
MAHAVEER
INSTITUTE OF SCIENCE & TECHNOLOGY
Bandlaguda, Hyd-500 005

Vysapuri, Bandlaguda Post:Keshavgiri,

Hyderabad-500 005, TELANGANA INDIA
Tel: 040-64896979,8978380692,Fax: 040-24456003
E-mail: e3hod.it@gmail.com,
Website: www.mist.ac.in,

MAHAVEER

INSTITUTE OF SCIENCE & TECHNOLOGY

Approved by AICTE, Affiliated to JNTUH,Hyd.



DEPARTMENT OF ELECTRONICS AND COMMUNICATION ENGINEERING

Java Certification programme QUESTION PAPER

Duration: 120 Minutes

10 X 3 = 30 Marks

Answer the following all questions. Each question carries 2 marks.

Q1. Explain JDK, JRE and JVM?

Q2. Explain public static void main(String

args[]) in Java

Q3. Why Java is platform independent?

Q4. Why Java is not 100% Object-oriented? Q5. What are wrapper classes in Java?

Q6. What are constructors in Java?

Q7. What is singleton class in Java and how can we make a class singleton? Q8. What is the difference between Array list and vector in Java?

Q9. What is the difference between equals() and == in Java?

Q10. What are the differences between Heap and Stack Memory in Java?

HOD-ECE

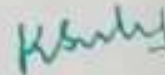

PRINCIPAL
MAHAVEER
INSTITUTE OF SCIENCE & TECHNOLOGY
Bandlaguda, Hyd-500 005

Vysapuri, Bandlaguda Post, Keshavgiri,

MAHAVEER

INSTITUTE OF SCIENCE & TECHNOLOGY

Approved by AICTE, Affiliated to JNTUH, Hyd.



Hyderabad-500 005, TELANGANA INDIA

Tel: 040-64596979, 8978380692, Fax: 040-24455003

E-mail: e3hod.it@gmail.com,

Website: www.mist.ac.in,

DEPARTMENT OF ELECTRONICS AND COMMUNICATION ENGINEERING

STUDENTS ATTENDANCE AND RESULT Java Certification program me

S.NO	H.T. NO.	NAME OF STUDENT	ATTENDACE 20)HRS	MARKS OBTAINED(30)
1	16E31A0401	ADABGINA AKSHAYA	17	27
2	16E31A0402	AENUGULA SWATHE	18	24
3	16E31A0403	ANAGOONI SHIVANI GOUD	18	14
4	16E31A0405	ASHALA GANESH	20	25
5	16E31A0406	AVVARI BHARGAVI	17	25
6	16E31A0407	H NAVYA SRI	20	15
7	16E31A0408	BADAM SAI SHANKER	17	14
8	16E31A0410	BYREDDY SRIDEVI	20	22
9	16E31A0413	DESHAM PREETHIKA	20	28
10	16E31A0415	DHARAVATHI THARUN	20	ABSENT
11	16E31A0416	ENJAMURI PAVAN SAI PREETAM	17	26
12	16E31A0418	G HARISH	18	12
13	16E31A0420	HASHI SHRUTHI	18	22
14	16E31A0421	JAGDM VAMSHKRISHNA	20	23
15	16E31A0422	KAKUSTAM PAVANI	17	22
16	16E31A0423	KALWAHARIEA	20	25
17	16E31A0426	KONAPARTHY ANJA CHARY	18	28
18	16E31A0427	KOTTALA VIKRAM	20	23
19	16E31A0428	KOYADA SWARNALATHA	19	29
20	16E31A0429	KULLARNI MANOJ	17	23
21	16E31A0430	LAGISHETTY ADITHYA	18	20
22	16E31A0433	MOHAMMAD AMEER KHAN	20	27
23	16E31A0435	PAKTEE GANESH	20	24
24	16E31A0436	PANYALA NAVYASREE	20	21
25	16E31A0437	PARIDULA SHEVA TEJA	20	15
26	16E31A0438	PETA SAI TEJA	18	25
27	16E31A0439	POKURI SHEKAR	18	20
28	16E31A0440	PRAVALIKA GADDAM	20	21
29	16E31A0442	RAPELLI HARIKA	18	25
30	16E31A0443	SHAIK RASHEEDA BEGUM	20	27

K. Sankar

PRINCIPAL

MAHAVEER

INSTITUTE OF SCIENCE & TECHNOLOGY

Vysapuri, Bandlaguda Post, Keshavnagar,

MAHAVEER

INSTITUTE OF SCIENCE & TECHNOLOGY

Approved by AICTE, Affiliated to JNTUH, Hyd.



Hyderabad-500 005, TELANGANA INDIA

Tel: 040-64596979, 6978380692 Fax: 040-24455003

E-mail: e3hod.ite@gmail.com

Website: www.mist.ac.in

DEPARTMENT OF ELECTRONICS AND COMMUNICATION ENGINEERING

31	16E31A0456	ABHILASH REDDY KODIGANTI	17	23
32	16E31A0457	AERUKALA SAI CHITRA	18	22
33	16E31A0459	ANANTHOJU SHIVANI	18	25
34	16E31A0460	ANKAM SRIVARSHA	20	28
35	16E31A0461	ANNABOINA SHALINI	17	23
36	16E31A0462	ANNAM SRAVAN	20	29
37	16E31A0463	ANUGONDA KIRAN KUMAR REDDY	18	23
38	16E31A0464	ANUMOLU NARENDRA SAI	20	20
39	16E31A0465	B PRADEEP	19	27
40	16E31A0466	BATTA SREE AMRUTH VAMSHI	17	24
41	16E31A0467	BIJALA SHRAVANI	18	21
42	16E31A0468	BODDUPALLI VAMSHIKRISHNA	20	25
43	16E31A0469	CH SUSHMITHA	20	25
43	16E31A0470	CHALLA VARUN REDDY	20	20
44	16E31A0471	CHEKKALA GANESH	20	21
45	16E31A0472	CHILUKA HARISH	18	23
46	16E31A0474	CHITTEPU PREMALATHA	19	22
47	16E31A0475	CHOLLETI KAVYA	20	23
48	16E31A0476	ELAGANDHALA VAMSHI PRANAY	18	22
49	16E31A0477	ELLENDULA VARSHITH	20	24
50	16E31A0479	GANGIREDDY MAHENDER	18	28

K. Sankar

PRINCIPAL
MAHAVEER
INSTITUTE OF SCIENCE & TECHNOLOGY
Bandlaguda, HYD-500 005.

Vysapuri, Bandlaguda Post: Keshavgiri,

Hyderabad-500 005, TELANGANA INDIA
Tel: 040-64596979, 8978380692, Fax: 040-24455003
E-mail: e3hod.it@gmail.com,
Website: www.mist.ac.in,

MAHAVEER

INSTITUTE OF SCIENCE & TECHNOLOGY

Approved by AICTE, Affiliated to JNTUH, Hyd.



DEPARTMENT OF ELECTRONICS AND COMMUNICATION ENGINEERING

SUMMARY REPORT OF Java Certification Programme

Java is one of the most popular programming languages used to create Web applications and platforms. It was designed for flexibility, allowing developers to write code that would run on any machine, regardless of architecture or platform.

Java is designed to be concurrent, class-based and object-oriented, as well as a computing platform.

First released by Sun Microsystems in 1995, an enormous amount of applications and websites

will not work unless you have Java installed, and more are created every day.

Java is advertised, and esteemed for its fast performance, security, and reliability.

COORDINATOR

Copy to:

1. Department Notice Board
2. Principal for Information
3. Committee Members (Academic)

PRINCIPAL
MAHAVEER
INSTITUTE OF SCIENCE & TECHNOLOGY
Bandlaguda, Hyd-500 005.

Attendance sheet for Java Certification programme registered students:

Slno	Hall Ticket No	Name of the Candidate	1	2	3	4	5	6	7	8	9	10	11	12	13	14	15	16	17	18	19	20	ATTENDANCE (%)
1	16E31A0401	ADARSHNA KESHAVA	1	3	4	5	6	7	8	A	9	A	10	11	A	12	14	14	14	15	16	17	17
2	16E31A0402	AENAGULA SWATHI	1	3	5	14	5	6	7	8	9	A	10	11	12	13	14	A	15	16	17	18	18
3	16E31A0403	ANAGUN SHIVANI GOUD	1	2	3	4	5	6	7	A	8	9	10	11	A	12	13	14	15	16	17	18	18
4	16E31A0405	ASHEETA GANESH	1	2	3	4	5	6	7	8	9	10	11	12	13	14	15	16	17	18	19	20	20
5	16E31A0406	AVVARE BHARGAVI	1	2	3	4	5	A	6	7	8	9	10	11	12	13	14	15	16	17	18	19	19
6	16E31A0407	B NAVYA SRI	1	2	3	4	5	6	7	8	9	A	10	11	12	A	13	14	15	16	17	18	18
7	16E31A0408	BADAM SAI SHANKER	1	2	3	4	5	6	7	8	9	A	10	11	12	A	13	14	15	16	17	18	18
8	16E31A0410	BIREDDY SREDEVI	1	2	3	4	5	6	7	8	9	10	11	12	13	14	15	16	17	18	19	20	20
9	16E31A0413	DESHAM PREETRIKA	1	2	3	4	5	6	7	8	9	10	11	12	13	14	15	16	17	18	19	20	20
10	16E31A0415	DHARAVATHI DHARUN	1	2	3	4	5	6	7	8	9	10	11	12	13	14	15	16	17	18	19	20	20
11	16E31A0416	ENJAMURIPAVAN SAI PREETAM	1	2	2	4	5	6	7	A	8	9	10	11	12	13	14	15	16	17	18	19	19
12	16E31A0418	G HARISH	1	2	3	4	5	6	7	8	9	A	10	11	12	A	13	14	15	16	17	18	18
13	16E31A0420	GADE SHRUTEJI	1	2	3	4	5	6	7	8	9	A	10	11	12	A	13	14	15	16	17	18	18
14	16E31A0421	JAGDE VAMSIKRISHNA	1	2	3	4	5	6	7	8	9	10	11	12	13	14	15	16	17	18	19	20	20
15	16E31A0422	KAKKUTAM PAVANTI	1	2	3	4	5	6	7	8	9	A	10	11	12	A	13	14	15	16	17	18	18
16	16E31A0423	KALWA HARIKA	1	2	3	4	5	6	7	8	9	10	11	12	13	14	15	16	17	18	19	20	20
17	16E31A0426	KONAPARTHY ANJAL CHARY	1	2	3	4	5	6	7	8	9	A	10	11	12	A	13	14	15	16	17	18	18
18	16E31A0427	KOTTALA VIKRAM	1	2	3	4	5	6	7	8	9	A	10	11	12	A	13	14	15	16	17	18	18
19	16E31A0428	KOVADA SWARNALATHA	1	2	3	4	5	6	7	8	9	A	10	11	12	A	13	14	15	16	17	18	18
20	16E31A0429	KULKARNI MANO	1	2	3	4	5	6	7	8	9	A	10	11	12	A	13	14	15	16	17	18	18
21	16E31A0430	LAGISHETTY ADITHYAN	1	2	3	4	5	6	7	8	9	A	10	11	12	A	13	14	15	16	17	18	18
22	16E31A0433	MUGHANIMAD AMEER KHAN	1	2	3	4	5	6	7	8	9	A	10	11	12	A	13	14	15	16	17	18	18
23	16E31A0435	PANDEY GANESH	1	2	3	4	5	6	7	8	9	A	10	11	12	A	13	14	15	16	17	18	18
24	16E31A0436	PANYALA NAVYASRIJEE	1	2	3	4	5	6	7	8	9	A	10	11	12	A	13	14	15	16	17	18	18
25	16E31A0437	PARTHA SHIVA TEJA	1	2	3	4	5	6	7	8	9	A	10	11	12	A	13	14	15	16	17	18	18
26	16E31A0438	PETA SAI TEJA	1	2	3	4	5	6	7	8	9	A	10	11	12	A	13	14	15	16	17	18	18
27	16E31A0439	POKURI SHEKAR	1	2	3	4	5	6	7	8	9	A	10	11	12	A	13	14	15	16	17	18	18
28	16E31A0440	PRAVALIKA GADIDAM	1	2	3	4	5	6	7	8	9	A	10	11	12	A	13	14	15	16	17	18	18
29	16E31A0442	RAPELLI HARINA	1	2	3	4	5	6	7	8	9	A	10	11	12	A	13	14	15	16	17	18	18
30	16E31A0443	SHAIK KASHEEDA BIBIUM	1	2	3	4	5	6	7	8	9	A	10	11	12	A	13	14	15	16	17	18	18

M A H A V E E
 INSTITUTE OF SCIENCE & TECHNOLOGY
 Bangalore, HYD-500 008

31	16E31A0456	ABHILASH REDDY KODIDANNI	1	2	3	U	K	6	7	8	9	A	10	11	12	13	14	15	16	17	18	19	20
32	16E31A0457	AERUKALA SAICHITRA	1	2	3	U	F	6	7	8	9	B	10	11	12	13	14	15	16	17	18	19	20
33	16E31A0459	ANANTHODU SHIVANI	1	2	3	U	K	6	7	8	9	A	10	11	12	13	14	15	16	17	18	19	20
34	16E31A0460	ANKAM SRIVARSHA	1	2	3	U	K	6	7	8	9	B	10	11	12	13	14	15	16	17	18	19	20
35	16E31A0461	ANNABOJINA BHALINI	1	2	3	U	K	6	7	8	9	B	10	11	12	13	14	15	16	17	18	19	20
36	16E31A0462	ANNAM SRAVAN	1	2	3	U	F	6	7	8	9	A	10	11	12	13	14	15	16	17	18	19	20
37	16E31A0463	REDDY	1	2	3	U	K	6	7	8	9	B	10	11	12	13	14	15	16	17	18	19	20
38	16E31A0464	ANUMICLU NARENDRA SAI	1	2	3	U	K	6	7	8	9	B	10	11	12	13	14	15	16	17	18	19	20
39	16E31A0465	B PRADEEP	1	2	3	U	F	6	7	8	9	B	10	11	12	13	14	15	16	17	18	19	20
40	16E31A0466	BIATTA SREE AMRUTHA VAMSHI	1	2	3	U	F	6	7	8	9	B	10	11	12	13	14	15	16	17	18	19	20
41	16E31A0467	BIJALA SHRAVAN	1	2	3	U	K	6	7	8	9	B	10	11	12	13	14	15	16	17	18	19	20
42	16E31A0468	BOJICUPALI VAMSHKRISHNA	1	2	3	U	K	6	7	8	9	B	10	11	12	13	14	15	16	17	18	19	20
43	16E31A0469	CH SUSHAMITHA	1	2	3	U	F	6	7	8	9	B	10	11	12	13	14	15	16	17	18	19	20
44	16E31A0470	CHALLA VARUN REDDY	1	2	3	U	F	6	7	8	9	B	10	11	12	13	14	15	16	17	18	19	20
45	16E31A0471	CHEKKALA GANESH	1	2	3	U	K	6	7	8	9	B	10	11	12	13	14	15	16	17	18	19	20
46	16E31A0472	CHILUKA HARISH	1	2	3	U	K	6	7	8	9	B	10	11	12	13	14	15	16	17	18	19	20
47	16E31A0474	CHITTEPU PREMALATHA	1	2	3	U	F	6	7	8	9	B	10	11	12	13	14	15	16	17	18	19	20
48	16E31A0475	CHOLETI SAVYA	1	2	3	U	F	6	7	8	9	B	10	11	12	13	14	15	16	17	18	19	20
49	16E31A0476	ELAGANDHALA VAMSHI PRANAY	1	2	3	U	K	6	7	8	9	B	10	11	12	13	14	15	16	17	18	19	20
50	16E31A0477	ELLENDULA VARSHITH	1	2	3	U	K	6	7	8	9	B	10	11	12	13	14	15	16	17	18	19	20
51	16E31A0479	GANGIREDDY MAHENDER	1	2	3	U	K	6	7	8	9	B	10	11	12	13	14	15	16	17	18	19	20

[Signature]
Coordinator

[Signature]

PRINCIPAL
MAHA VEER
Principal of Sree Siddhaganga
Engineering College
Benevolence, HYD-500 005.

[Signature]
HOD, ECE Dept

Vysapuri, Bandlaguda Post:Keshavgi,

Hyderabad-500 005, TELANGANA INDIA
Tel: 040-64596979,8978380692 Fax: 040-24455003
E-mail: e3hod_cse@gmail.com
Website: www.mist.ac.in

MAHAVEER

INSTITUTE OF SCIENCE & TECHNOLOGY

Approved by AICTE, Affiliated to JNTUH,Hyd.



DEPARTMENT OF COMPUTER SCIENCE AND ENGINEERING

Date: 01-12-2020

CIRCULAR

Technical Trainings for II & IV B. Tech students are starting from 29-012-2020 onwards. All HODs and placements coordinators have to manage the trainings and ensure 95% attendance all through the sessions.

All mentors need to send the compiled feedback report to HOD at e3hod_cse@gmail.com daily. Mentors are advised to take care of PNR (Students not participating in training).

Agenda: **Basic Web Designing**

HOD-CSE

PRINCIPAL
MAHAVEER
INSTITUTE OF SCIENCE & TECHNOLOGY
Bandlaguda, Hyd-500 005.

Vysapuri, Bandlaguda Post:Keshavgiri,

Hyderabad-500 005, TELANGANA INDIA
Tel: 040-84596979,8978380692. Fax: 040-24455003
E-mail: e3hod.cse@gmail.com.
Website: www.mist.ac.in,

MAHAVEER

INSTITUTE OF SCIENCE & TECHNOLOGY

Approved by AICTE, Affiliated to JNTUH,Hyd.



DEPARTMENT OF COMPUTER SCIENCE AND ENGINEERING

SYLLABUS FOR Basic Web Designing

SNO	TOPIC COVERED	DURATION
1	Multimedia and its Applications	3
2	Mathematical Structure for Computer Science	3
3	Web Technologies	3
4	CSS	3
5	JavaScript	3
6	Adobe Flash	3
7	Animation Techniques	3
8	Introduction to Web Designing	3
9	Basics of Web Designing	3
10	Computer Graphics	3
11	HTML	3
12	Bootstrap	2
13	Adobe Dreamweaver	2
14	Softwares for Graphic Designing	2

HOD-CSE

PRINCIPAL
MAHAVEER
INSTITUTE OF SCIENCE & TECHNOLOGY
Bandlaguda, Hyd-500 005.

Vysapuri, Bandlaguda Post:Keshavgirl,

Hyderabad-500 005, TELANGANA INDIA
Tel: 040-64596979,8978380692,Fax: 040-24455003
E-mail: e3hod.cse@gmail.com,
Website: www.mist.ac.in,

MAHAVEER
INSTITUTE OF SCIENCE & TECHNOLOGY
Approved by AICTE, Affiliated to JNTUH,Hyd.



DEPARTMENT OF COMPUTER SCIENCE AND ENGINEERING

LIST OF REGISTERED STUDENTS FOR Basic web designing

SNO	HALL TICKET NO	NAME OF THE STUDENT
1	17E31A0501	A SHIRISHA
2	17E31A0502	BANDARI VARUN KUMAR
3	17E31A0504	BOGEE SUPRIYA
4	17E31A0507	CHEEMALA MAHESH
5	17E31A0508	CHELLOJU ANUSHA
6	17E31A0509	CHENCHU HARISH
7	17E31A0510	D GANESH
8	17E31A0512	G.HARIKA
9	17E31A0514	GANECHARY SHREYA
10	17E31A0515	GEETHIKA C
11	17E31A0516	GURRAM MANI RUPAK
12	17E31A0517	HUSNA HIBA
13	17E31A0519	JANUMPALLY GAYATHRI REDDY
14	17E31A0520	KANKATI ARAVIND
15	17E31A0521	KASULA VISHAKA
16	17E31A0522	KONGARI CHANDANA
17	17E31A0523	KOPPULA ANUSHRI
18	17E31A0525	KURA AKHILESH
19	17E31A0526	L ANIKETH SINGH
20	17E31A0528	LONE HARISH

Handwritten signature

ORIGINAL
MAHAVEER
INSTITUTE OF SCIENCE & TECHNOLOGY
BANDLAGUDA, HYD

Vysapuri, Bandlaguda Post:Keshavgiri,

Hyderabad-500 005, TELANGANA INDIA
Tel: 040-64596979,8978380692,Fax: 040-24455003
E-mail: e3hod.cse@gmail.com,
Website: www.mist.ac.in,

MAHAVEER

INSTITUTE OF SCIENCE & TECHNOLOGY

Approved by AICTE, Affiliated to JNTUH,Hyd.



DEPARTMENT OF COMPUTER SCIENCE AND ENGINEERING

21	17E31A0530	MADDI MAIBU
22	17E31A0532	MANDAPURAM VINITHA
23	17E31A0533	MD ISMAIL
24	17E31A0537	PEDDOLLA ANAND REDDY
25	17E31A0539	RAGULA REKHA
26	17E31A0581	P LOKESH
27	17E31A0582	PATEL SAHITHI
28	17E31A0583	PENDYALA SAIDEIPA
29	17E31A0584	RAPOLU KALYAANI
30	17E31A0585	RIKKULA BHAVANI
31	17E31A0586	SAMUDRALA SAITEJA
32	17E31A0587	SERUSANI VIDHYA
33	17E31A0588	SYED ABDUL RAFEH
34	17E31A0589	SYED AFRIDI
35	17E31A0590	SYED OZAIR
36	19E31A0501	KUSUMBHA HEMANTH
37	19E31A0502	A JHANAVI
38	19E31A0503	ADICHERLA DHRUVAN
39	19E31A0504	ALCHETI PRAPUL
40	19E31A0505	ANDE SAI KIRAN
41	19E31A0506	ANTHA REDDY YESHWANTH REDDY

PRINCIPAL

MAHAVEER

INSTITUTE OF SCIENCE & TECHNOLOGY

Hyderabad, 500 005

Vysapuri, Bandlaguda Post:Keshavgiri,

Hyderabad-500 005, TELANGANA INDIA
Tel: 040-64596979,8978380692 Fax: 040-24455003
E-mail: e3hod.cse@gmail.com,
Website: www.mist.ac.in,

MAHAVEER

INSTITUTE OF ENGINEERING & TECHNOLOGY
Approved by AICTE, Affiliated to JNTUH,Hyd.



DEPARTMENT OF COMPUTER SCIENCE AND ENGINEERING

42	19E31A0507	BOMMENA PHANI CHANDAN
43	19E31A0508	BOOSLA MEGHANA
44	19E31A0509	C PRAKASH
45	19E31A0510	CHITYALA MANOJ KUMAR
46	19E31A0557	AMGOTHA TIRUPATI
47	19E31A0558	AMOHAMMED MUQTAR MOHIUDDIN
48	19E31A0559	ASANABADHA RANJITHKUMAR
49	19E31A0560	BADA ANUSH
50	19E31A0561	BURRA HARSHITHA YADAV
51	19E31A0562	CHITIKALA KARTHIK
52	19E31A0563	GALIPELLI HARSHINI
53	19E31A0564	GOLLA RAVEENA
54	19E31A0565	HASSA FATIMA
55	19E31A0566	JANGA ABHISHEK
56	19E31A0567	KALLURI JYOTHIRMAI
57	19E31A0568	KAMRAN ALI AHMED
58	19E31A0569	KEMIDI SHIREESHA
59	19E31A0570	KHAMMAMPATI SAMYUKTHA
60	19E31A0571	KUMMAM RAHUL
61	19E31A0572	MANEPALLI HARSHA VARDHAN
62	19E31A0573	MATHANGI VIKITHA

PRINCIPAL
MAHAVEER
INSTITUTE OF ENGINEERING & TECHNOLOGY
Bandlaguda, Hyderabad

Vysapuri, Bandlaguda Post:Keshavgiri,

Hyderabad-500 005, TELANGANA INDIA
Tel: 040-64596979,8978380692,Fax: 040-24455003
E-mail: e3hod.cse@gmail.com,
Website: www.mist.ac.in.

MAHAVEER

INSTITUTE OF SCIENCE & TECHNOLOGY

Approved by AICTE, Affiliated to JNTUH,Hyd.



DEPARTMENT OF COMPUTER SCIENCE AND ENGINEERING

63	19E31A0574	MIRIYALA SOMESHWARI
64	19E31A0575	MUSUNURU KAMAL NADH
65	19E31A0576	N MOUNIKA
66	19E31A0587	VISHAL KAKANI
67	19E31A0588	KOPPULA SHIVANI

PRINCIPAL
MAHAVEER
INSTITUTE OF SCIENCE & TECHNOLOGY
Bandlaguda, Hyd-500 005.

Vysapuri, Bandlaguda Post:Keshavgirl,

Hyderabad-500 005, TELANGANA INDIA
Tel: 040-64596979,8978380692,Fax: 040-24455003
E-mail: e3hod.cse@gmail.com,
Website: www.mist.ac.in,

MAHAVEER

INSTITUTE OF SCIENCE & TECHNOLOGY

Approved by AICTE, Affiliated to JNTUH,Hyd.



DEPARTMENT OF COMPUTER SCIENCE AND ENGINEERING

Basic Web Designing QUESTION PAPER

Duration: 120 Minutes

8 X 2.5 = 20 Marks

Answer the following all questions. Each question carries 2.5 marks.

- 1.What are the most commonly used languages and platforms for website design?
- 2.What is HTML?
- 3.What is the function of CSS in web design?
- 4.What is an external style sheet?
- 5.Differentiate between HTML elements and HTML tags?
- 6.What is Semantic HTML?
7. What could be the problem of the hyperlink or image is not displaying correctly?
8. Is HTML and CSS enough to create a website?

HOD-CSE

PRINCIPAL
M I MAHAVEER

INSTITUTE OF SCIENCE & TECHNOLOGY
Bandlaguda, Hyderabad

Vysapuri, Bandlaguda Post:Keshavgiri,

Hyderabad-500 005, TELANGANA INDIA

Tel: 040-64596979,8978380692.Fax: 040-24455003

E-mail: e3hod.cse@gmail.com.

Website: www.mist.ac.in,

MAHAVEER

INSTITUTE OF SCIENCE & TECHNOLOGY

Approved by AICTE, Affiliated to JNTUH,Hyd.



DEPARTMENT OF COMPUTER SCIENCE AND ENGINEERING

RESULT SHEET FOR Basic Web designing REGISTERED STUDENTS

SNO	HALL TICKET NO	NAME OF THE STUDENT	MARKS (20)	RESULT
1	17E31A0501	A SHIRISHA	20	PASS
2	17E31A0502	BANDARI VARUN KUMAR	19	PASS
3	17E31A0504	BOGEE SUPRIYA	20	PASS
4	17E31A0507	CHEEMALA MAHESH	18	PASS
5	17E31A0508	CHELLOJU ANUSHA	20	PASS
6	17E31A0509	CHENCHU HARISH	20	PASS
7	17E31A0510	D GANESH	16	PASS
8	17E31A0512	G.HARIKA	20	PASS
9	17E31A0514	GANECHARY SHREYA	20	PASS
10	17E31A0515	GEETHIKA C	17	PASS
11	17E31A0516	GURRAM MANI RUPAK	20	PASS
12	17E31A0517	HUSNA HIBA	20	PASS
13	17E31A0519	JANUMPALLY GAYATHRI REDDY	16	PASS
14	17E31A0520	KANKATI ARAVIND	20	PASS
15	17E31A0521	KASULA VISHAKA	20	PASS
16	17E31A0522	KONGARI CHANDANA	18	PASS
17	17E31A0523	KOPPULA ANUSHRI	20	PASS
18	17E31A0525	KURA AKHILESH	19	PASS
19	17E31A0526	L ANIKETH SINGH	20	PASS

PRINCIPAL
MAHAVEER
INSTITUTE OF SCIENCE & TECHNOLOGY
Bandlaguda, Hyderabad

Vysapuri, Bandlaguda Post:Keshavgiri,

Hyderabad-500 005, TELANGANA INDIA

Tel: 040-64596979,8978380692, Fax: 040-24455003

E-mail: e3hod.cse@gmail.com,

Website: www.mist.ac.in,

MAHAVEER

INSTITUTE OF SCIENCE & TECHNOLOGY

Approved by AICTE. Affiliated to JNTUH,Hyd.



DEPARTMENT OF COMPUTER SCIENCE AND ENGINEERING

20	17E31A0528	LONE HARISH	18	PASS
21	17E31A0530	MADDI MAIBU	20	PASS
22	17E31A0532	MANDAPURAM VINITHA	20	PASS
23	17E31A0533	MD ISMAIL	16	PASS
24	17E31A0537	PEDDOLLA ANAND REDDY	20	PASS
25	17E31A0539	RAGULA REKHA	20	PASS
26	17E31A0581	P LOKESH	20	PASS
27	17E31A0582	PATEL SAHITHI	18	PASS
28	17E31A0583	PENDYALA SAIDEIPA	20	PASS
29	17E31A0584	RAPOLU KALYAANI	19	PASS
30	17E31A0585	RIKKULA BHAVANI	20	PASS
31	17E31A0586	SAMUDRALA SAITEJA	18	PASS
32	17E31A0587	SERUSANI VIDHYA	20	PASS
33	17E31A0588	SYED ABDUL RAFEH	20	PASS
34	17E31A0589	SYED AFRIDI	16	PASS
35	17E31A0590	SYED OZAIR	20	PASS
36	19E31A0501	KUSUMBHA HEMANTH	20	PASS
37	19E31A0502	A JHANAVI	17	PASS
38	19E31A0503	ADICHERLA DHRUVAN	20	PASS
39	19E31A0504	ALCHETI PRAPUL	20	PASS
40	19E31A0505	ANDE SAI KIRAN	16	PASS

PRINCIPAL
MAHAVEER
INSTITUTE OF SCIENCE & TECHNOLOGY
Bandlaguda, Hy. 500 005

Vysapuri, Bandlaguda Post:Keshavgirl,

MAHAVEER

INSTITUTE OF SCIENCE & TECHNOLOGY

Approved by AICTE. Affiliated to JNTUH,Hyd.



Hyderabad-500 005, TELANGANA INDIA
Tel: 040-64596979,8978380692.Fax: 040-24455003
E-mail: e3hod.cse@gmail.com,
Website: www.mist.ac.in.

DEPARTMENT OF COMPUTER SCIENCE AND ENGINEERING

41	19E31A0506	ANTHA REDDY YESHWANTH REDDY	20	PASS
42	19E31A0507	BOMMENA PHANI CHANDAN	20	PASS
43	19E31A0508	BOOSLA MEGHANA	18	PASS
44	19E31A0509	C PRAKASH	20	PASS
45	19E31A0510	CHITYALA MANOJ KUMAR	19	PASS
46	19E31A0557	AMGOTHA TIRUPATI	20	PASS
47	19E31A0558	AMOHAMMED MUQTAR MOHIUDDIN	18	PASS
48	19E31A0559	ASANABADHA RANJITHKUMAR	20	PASS
49	19E31A0560	BADA ANUSH	20	PASS
50	19E31A0561	BURRA HARSHITHA YADAV	16	PASS
51	19E31A0562	CHITIKALA KARTHIK	20	PASS
52	19E31A0563	GALIPELLI HARSHINI	20	PASS
53	19E31A0564	GOLLA RAVEENA	20	PASS
54	19E31A0565	HASSA FATIMA	18	PASS
55	19E31A0566	JANGA ABHISHEK	19	PASS
56	19E31A0567	KALLURI JYOTHIRMAI	20	PASS
57	19E31A0568	KAMRAN ALI AHMED	18	PASS
58	19E31A0569	KEMIDI SHIREESHA	17	PASS
59	19E31A0570	KHAMMAMPATI SAMYUKTHA	16	PASS
60	19E31A0571	KUMMAM RAHUL	20	PASS

PRINCIPAL
MAHAVEER
INSTITUTE OF SCIENCE & TECHNOLOGY
Bandlaguda, Hyderabad

Vysapuri, Bandlaguda Post:Keshavgiri,

MAHAVEER

INSTITUTE OF SCIENCE & TECHNOLOGY

Approved by AICTE, Affiliated to JNTUH,Hyd.



Hyderabad-500 005, TELANGANA INDIA

Tel: 040-64596979,8978380692,Fax: 040-24455003

E-mail: e3hod.cse@gmail.com

Website: www.mist.ac.in

DEPARTMENT OF COMPUTER SCIENCE AND ENGINEERING

61	19E31A0572	MANEPALLI HARSHA VARDHAN	20	PASS
62	19E31A0573	MATHANGI VIKITHA	20	PASS
63	19E31A0574	MIRIYALA SOMESHWARI	18	PASS
64	19E31A0575	MUSUNURU KAMAL NADH	19	PASS
65	19E31A0576	N MOUNIKA	20	PASS
66	19E31A0587	VISHAL KAKANI	18	PASS
67	19E31A0588	KOPPULA SHIVANI	17	PASS

No. of students Registered:67

No. of students Passed:67

No. of students failed:NIL

PRINCIPAL
MAHAVEER
INSTITUTE OF SCIENCE & TECHNOLOGY
Bandlaguda, Hyd-500 005

Vysapuri, Bandlaguda Post:Keshavgiri,

Hyderabad-500 005, TELANGANA INDIA
Tel: 040-64596979,8978380692.Fax: 040-24455003
E-mail: eshod.cse@gmail.com,
Website: www.mist.ac.in,

MAHAVEER

INSTITUTE OF DISTANCE EDUCATION

Approved by AICTE, Affiliated to JNTUH,Hyd



DEPARTMENT OF COMPUTER SCIENCE AND ENGINEERING

SUMMARY REPORT OF Basic Web Designing

- Layout. If you want to design and build websites, understanding good layout is key. We suggest keeping things minimal.
- Color. You have the colors of the rainbow and beyond available to you. ... The power of the color picker can be wielded.
- Typography. Webflow comes with a wide selection of fonts and the option to add more. Typography is two-dimensional.

COORDINATOR

Copy to:

1. Department Notice Board
2. Principal for Information
3. Committee Members (Academic)

PRINCIPAL
MANAGER
INSTIT. OF DISTANCE EDUCATION
BANDLAGUDA, HYD.

Vysapuri, Bandlaguda Post:Keshavgiri,

Hyderabad-500 005, TELANGANA INDIA
Tel: 040-64596979,8978380692, Fax: 040-24455003
E-mail: e3hod.it@gmail.com,
Website: www.mist.ac.in,

MAHAVEER

INSTITUTE OF SCIENTIFIC TECHNOLOGY

Approved by AICTE, Affiliated to JNTUH,Hyd.



DEPARTMENT OF INFORMATION TECHNOLOGY

Date:01/09/2017

To,

The principal,
MIST,
Hyderabad.

Sub: Proposal for Add-on Course-Reg.

Dear Sir,

We are going to conduct two weeks workshop on **Training - C programming**. We require your approval to go head for further proceeding and hope to get an opportunity to serve you the best.

With thanks and Regards,

A. K. Reddy
MIST
MAHAVEER
INSTITUTE OF SCIENTIFIC TECHNOLOGY
Bandlaguda, Hyderabad 500 005.

Vysapuri, Bandlaguda Post:Keshavgiri,

Hyderabad-500 005, TELANGANA INDIA
Tel: 040-64596979,8978380692 Fax: 040-24455003
E-mail: e3hod.it@gmail.com,
Website: www.mist.ac.in,

MAHAVEER

INSTITUTE OF ENGINEERING & TECHNOLOGY

Approved by AICTE, Affiliated to JNTUH,Hyd.



DEPARTMENT OF INFORMATION TECHNOLOGY

Date: 04-09-2017

CIRCULAR

Technical Trainings for III & IV B. Tech students are starting from 11-09-2017 onwards. All HODs and placements coordinators have to manage the trainings and ensure 95% attendance all through the sessions.

All mentors need to send the compiled feedback report to HOD at e3hod@gmail.com daily. Mentors are advised to take care of PNR (Students not participating in training).

Agenda: Training - C programming

Design and Development of Curriculum for Add on Course:

Name of the Faculty- 1.CH B NAGALAKSHMI
2.S.SRINIVAS
3.V NARESH KUMAR REDDY

Kanthy
M. S. Srinivas
Department of Information Technology
Hyderabad-500 005

Kanthy
HOD

Vysaapuri, Bandlaguda Post: Keshavnagar,

MAHAVEER



Hyderabad-500 005, TELANGANA INDIA
Tel: 040-64596979, 8978380692 Fax: 040-24455003
E-mail: e3hod.it@gmail.com
Website: www.mist.ac.in,

Approved by AICTE, Affiliated to JNTUH Hyd.

DEPARTMENT OF INFORMATION TECHNOLOGY

SYLLABUS FOR Training - C programming

SNO	TOPIC COVERED	DURATION
1	Introduction to Principles of programming	3
2	Introduction to C Programming	1
3	Operators and Expressions	1
4	Data Types and Input/Output Operators	3
5	Control Statements and Decision Making	3
6	Arrays and Strings	3
7	Pointers	3
8	Structures and Unions	3
9	Functions	3
10	Storage Classes	3
11	The Preprocessor	3
12	Dynamic Memory Allocation	3
13	File Management	3

Handwritten signature in green ink.
MAHAVEER
DEPARTMENT OF INFORMATION TECHNOLOGY
BANDLAGUDA POST, HYD-500 005.

Handwritten signature in black ink.



DEPARTMENT OF INFORMATION TECHNOLOGY

LIST OF REGISTERED STUDENTS FOR Training - C programming

SNO	HALL TICKET NO	NAME OF THE STUDENT
1	14E31A1202	AREKATLA DIVYA
2	14E31A1204	B SAI KIRAN REDDY
3	14E31A1205	BANDIYALA AKSHAY REDDY
4	14E31A1206	DEVARANE NI SRAVANI
5	14E31A1208	GANGIDI ANUSHA
6	14E31A1209	GANTE SANTOSH
7	14E31A1210	GUDA SAI AKHIL
8	14E31A1211	KAVITHA LALANI
9	14E31A1212	KORASIKA SATEERAN
10	14E31A1214	KURNAMONI DILIP
11	14E31A1215	MAHENDER SINGH
12	14E31A1216	MAMIDIPALLY MOUNIKA
13	14E31A1218	NALIMELA VINAY REDDY
14	14E31A1220	NARAGONISHIVA VENKATA SAI
15	14E31A1221	PRANATHI PADARANI
16	14E31A1222	RAMA RAKESH
17	14E31A1223	RAMIDI KAVYA REDDY
18	14E31A1224	SRIERAMNENI SRUJANA
19	14E31A1225	THIPPARAPU SRIVANI
20	14E31A1227	VEERAMREDDY MANASA
21	15E31A1202	AMAN SINGH BADDYAL
22	15E31A1203	ARUTLA RAJ GOPAL
23	15E31A1204	BALLA UPENDRA
24	15E31A1205	BAL MOORI SAHITHI
25	15E31A1206	CHAITA NIKHIL KUMAR
26	15E31A1207	D KRISHNA SREE
27	15E31A1208	D LAXMI SAROJA
28	15E31A1209	DORAGARI NIKHITHA
29	15E31A1210	DUMALA VENU
30	15E31A1211	GANDHIASIRI BIHARATHI KUMAR
31	15E31A1212	GUNNALA SIRISHA
32	15E31A1213	K RASHMITHA
33	15E31A1214	KALIGOTA VIGNESH REDDY
34	15E31A1215	KAPARTHI SRIVARDHAN
35	15E31A1216	KARKONI NILESH
36	15E31A1217	KATAM PRIYANKA
37	15E31A1218	KATHROJU ASHOK
38	15E31A1219	KOLANU GRESHMA REDDY
39	15E31A1220	KONIDENA SAI VARSHITHA
40	15E31A1221	KOTLA VISWASRI
41	15E31A1222	KURUKUNTLA HARISH SAGAR

Handwritten signature and stamp in blue ink.

Vijaya Vittala, Basavanguda Post, Kothavathi,

MAHAVEER



Hyderabad-500 005, TELANGANA INDIA

Tel: 040-64596979,8978380602 Fax: 040-24456003

E-mail: ejhod.tb@gmail.com,

Website: www.mist.ac.in,

Approved by AICTE, Affiliated to JNTUH,Hyd.

DEPARTMENT OF INFORMATION TECHNOLOGY

42	15E31A1223	KUSUMA SAI VAMSHI ADITYA
43	15E31A1224	M BHAGYA LAXMI
44	15E31A1225	MITTAKANTI ANUSHA
45	15E31A1228	PINGALI SINDHU
46	15E31A1229	POSHETTY MANISHA
47	15E31A1231	SRI PEDAMHODUR SRINIVAS SWAMY
48	15E31A1232	TUNIKI SHIVAKUMAR
49	15E31A1233	VILASAGARAM DEVENDAR
50	15E31A1235	YETHONDA NARAHARIKRISHNA
51	15E31A1243	K AKSHAY REDDY

Handwritten signature in green ink.
P
M
K
Basavanguda, Hyderabad-500 005

K. J. Somayaji, Banafalguda Post, Keshavnagar,

MAHAVEER



Hyderabad-500 005, TELANGANA INDIA

Tel: 040-64506079, 8978380692, Fax: 040-24455003

E-mail: info@mahaveer.ac.in

Website: www.mist.ac.in

Approved by AICTE, Affiliated to JNTUH, Hyd

DEPARTMENT OF INFORMATION TECHNOLOGY

Training - C programming QUESTION PAPER

Duration: 120 Minutes

10 X 2 = 20 Marks

Answer the following all questions. Each question carries 2 marks.

1. Distinguish between malloc() & calloc() memory allocation.
2. Explain the syntax for for-loop.
3. What is recursion?
4. What is typecasting?
5. What are command line arguments?
6. What is a preprocessor?
7. What is a self-referential structure?
8. What is the difference between actual and formal parameters?
9. What is the purpose of the keyword typedef?
10. What are storage classes?

M. Key
ODD IT

K. Somayaji

PRINCIPAL
MAHAVEER
INSTITUTE OF SCIENCE & TECHNOLOGY
Banafalguda, Hyd-500 005.

K. J. Somayaji, Bandlaguda Post, Keshavnagar,

MAHAVEER



Hyderabad-500 805, TELANGANA INDIA
Tel: 040-64590979, 8978380692 Fax: 040-24455003
E-mail: eshorlit@gmail.com
Website: www.mist.ac.in

Approved by AICTE, Affiliated to JNTUH, Hyd.

DEPARTMENT OF INFORMATION TECHNOLOGY

RESULT SHEET FOR Training - C programming REGISTERED STUDENTS

SNO	HALL TICKET NO	NAME OF THE STUDENT	MARKS (20)	RESULT
1	14E31A1202	AREKAITLA DIVYA	20	PASS
2	14E31A1204	B SAIKIRAN REDDY	19	PASS
3	14E31A1205	BANDHYALA AKSHAY REDDY	20	PASS
4	14E31A1206	DEVARANENI SRAVANI	18	PASS
5	14E31A1208	GANGIDI ANUSHA	20	PASS
6	14E31A1209	GANTE SANTHOSH	20	PASS
7	14E31A1210	GUDA SAI AKHIL	16	PASS
8	14E31A1211	KAVETHI ALANI	20	PASS
9	14E31A1212	KORASIKA SAI KIRAN	20	PASS
10	14E31A1214	KURNAMONI DILIP	17	PASS
11	14E31A1215	MAHENDER SINGH	20	PASS
12	14E31A1216	MAMIDIPALLY MOUNIKA	20	PASS
13	14E31A1218	NALIMELA VINAY REDDY	16	PASS
14	14E31A1220	NARAGONI SHIVA VENKATA SAI	20	PASS
15	14E31A1221	PRANATHI PADAKANTI	20	PASS
16	14E31A1222	RAMA RAKESH	18	PASS
17	14E31A1223	RAMIDI KAVYA REDDY	20	PASS
18	14E31A1224	SREERAMINENI SRUJANA	19	PASS
19	14E31A1225	THIPPARAPU SRIVANI	20	PASS
20	14E31A1227	VIERAMREDDY MANASA	18	PASS
21	15E31A1202	AMAN SINGH BADYAL	20	PASS
22	15E31A1203	ARUTLA RAJ GOPAL	19	PASS
23	15E31A1204	BALLA UPENDRA	20	PASS
24	15E31A1205	BALMORI SAHITHI	18	PASS
25	15E31A1206	CHATLA NIKHIL KUMAR	20	PASS
26	15E31A1207	D KRISTINA SRI	20	PASS
27	15E31A1208	D LAXMI SAROJA	16	PASS
28	15E31A1209	DORAGARI NIKHITHA	20	PASS
29	15E31A1210	DUMALA VENU	20	PASS
30	15E31A1211	GANDHASIRI BHARATH KUMAR	17	PASS
31	15E31A1212	GUNNALA SIRISHA	20	PASS
32	15E31A1213	K RASHIMITHA	20	PASS
33	15E31A1214	KALIGOTA VIGNESH REDDY	16	PASS
34	15E31A1215	KAPARTHI SRIVARDHAN	20	PASS
35	15E31A1216	KARKONI NILESH	20	PASS
36	15E31A1217	KATAM PRIYANKA	18	PASS
37	15E31A1218	KATHROJU ASHOK	20	PASS
38	15E31A1219	KOLANU GREESHMA REDDY	19	PASS
39	15E31A1220	KONIDENA SAI VARSHITHA	20	PASS
40	15E31A1221	KOTLA VISWASRI	18	PASS
41	15E31A1222	KURUKUNTLA HARISH SAGAR	20	PASS

MAHAVEER INSTITUTE OF TECHNOLOGY
K. J. Somayaji, Bandlaguda Post, Keshavnagar, Hyderabad-500 805, TELANGANA INDIA



DEPARTMENT OF INFORMATION TECHNOLOGY

1	19131A1221	KUSUMASAI CAMISHI ADITYA	50	PASS
12	19131A1224	ATHIRAGYALAXMI	16	PASS
13	19131A1225	MILITAKANTANUSILA	20	PASS
14	19131A1226	PINGALI SINDHU	20	PASS
15	19131A1229	TOSHITHY ANAGSHA	20	PASS
17	19131A1231	SRIPEEDABHIDUR SRINIVASSWAMY	18	PASS
18	19131A1232	U. NIKESHIAKATAR	19	PASS
19	19131A1233	VILASAGARAM DEVA NIDAR	18	PASS
40	19131A1238	YETHINDA SARAHARIKRISHNA	17	PASS
41	19131A1239	K. AKSHAY BHIDDU	19	PASS

No. of students Registered: 51
No. of students Passed: 51
No. of students failed: Nil

Kanthy
PRINCIPAL
MAHAVEER
INSTITUTE OF SCIENCE & TECHNOLOGY
Keesara, Hyd-509 005.

Venugopal, Hanamanguda Post, Keshavnagar,

MAHAVEER



Hyderabad-500 005, TELANGANA INDIA
Tel: 040-64506979,8978388692, Fax: 040-24455003
E-mail: cihed.its@gmail.com,
Website: www.mist.ac.in,

Approved by AICTE, Affiliated to JNTUH,Hyd.

DEPARTMENT OF INFORMATION TECHNOLOGY

SUMMARY REPORT OF Training - C programming

C is robust language and has rich set of built-in functions, data types and operators which can be used to write any complex program.

Program written in C are efficient due to availability of several data types and operators.

C is good choice for system-level programming. Nevertheless, it is not perfect for all programmers and all situations.

C pointers are a common source of confusion and programming errors.

C also lacks explicit support for useful abstractions such as classes and objects.

That may be a reason C is not preferable language for application-level programming.

Newer languages such as C++ and Java address these issues for application-level programs.

C programming language is not limited to but used widely in operating systems, language compilers, network drivers, language interpreters, and system utilities areas of development.

COORDINATOR

Copy to:

1. Department Notice Board
2. Principal for Information
3. Committee Members (Academic)

PRINCIPAL
MAHAVEER
INSTITUTE OF SCIENCE & TECHNOLOGY
Hanamanguda, Hyd-500 005



Vysapuri, Bandlaguda Post:Keshavgi,

Hyderabad-500 005, TELANGANA INDIA

Tel: 040-64596979,8978380692 Fax: 040-24455003

E-mail: e3hod.it@gmail.com,

Website: www.mist.ac.in,

MAHAVEER

INSTITUTE OF SCIENCE & TECHNOLOGY

Approved by AICTE, Affiliated to JNTUF, Hyd.



DEPARTMENT OF INFORMATION TECHNOLOGY

Date: 25-01-2018

To,

The principal,
MIST,
Hyderabad.

Sub: Proposal for Add-on Course-Reg.

Dear Sir,

We are going to conduct two weeks workshop on **Java Certification programme**. We request your approval to go ahead for further proceeding and hope to get an opportunity to serve you the best.

With thanks and Regards

Head of Department
Department of Information Technology
Mahaveer Institute of Science & Technology
Bandlaguda, Hyd-500 005.

Keshavgi
PRINCIPAL
MAHAVEER
INSTITUTE OF SCIENCE & TECHNOLOGY
Bandlaguda, Hyd-500 005.

Vysapuri, Bandlaguda Post:Keshavgi,ri,

Hyderabad-500 005, TELANGANA INDIA
Tel: 040-64596979,8978380692,Fax: 040-24455003
E-mail: e3hod.it@gmail.com,
Website: www.mist.ac.in,

MAHAVEER

INSTITUTE OF SCIENCE & TECHNOLOGY

Approved by AICTE, Affiliated to JNTUH,Hyd.



DEPARTMENT OF INFORMATION TECHNOLOGY

Date: 01-02-2018

CIRCULAR

Technical Trainings for II & IV B. Tech students are starting from 12-02-2018 onwards. All HODs and placements coordinators have to manage the trainings and ensure 95% attendance all through the sessions.

All mentors need to send the compiled feedback report to HOD at e3hod@gmail.com daily. Mentors are advised to take care of PNR (Students not participating in training).

Agenda: Java Certification programme

Design and Development of Curriculum for Add on Course:

Name of the Faculty: 1.CH B NAGALAKSHMI
2.A.NANDA GOPAL REDDY
3.KBVK NAGA SREE

[Handwritten Signature]
HOD.

Head of Department
Department of Information Technology
Mahaveer Institute of Science & Technology
Bandlaguda, Hyderabad-500 005

[Handwritten Signature]
PRINICIPAL
MAHAVEER
INSTITUTE OF SCIENCE & TECHNOLOGY
Bandlaguda, Hyd-500 005.

Vysapuri, Bandlaguda Post:Keshavgiri,

Hyderabad-500 005, TELANGANA INDIA
Tel: 040-64596979,8978380692,Fax: 040-24455003
E-mail: e3hod.it@gmail.com,
Website: www.mist.ac.in,

MAHAVEER

INSTITUTE OF SCIENCE & TECHNOLOGY

Approved by AICTE, Affiliated to JNTUH,Hyd.



DEPARTMENT OF INFORMATION TECHNOLOGY

SYLLABUS FOR Java Certification programme

SNO	TOPIC COVERED	DURATION
1	Introduction	3
2	OOPS (Object Oriented Programming & Systems)	3
3	STRING Manipulation	3
4	Array	3
5	Packages	3
6	Exception Handling	3
7	I/O Streams	3
8	Multithreading	3
9	Wrapper Classes	3
10	Inner Classes	3
11	Collection Frame Work	3
12	AWT	3
13	SWING (JFC)	3

[Handwritten Signature]
HOD-IT

Head of Department
Department of Information Technology
Mahaveer Institute of Science & Technology
Vysapuri, Bandlaguda Post, Keshavgiri, Hyderabad-500 005, Telangana India

[Handwritten Signature]
PRINCIPAL
MAHAVEER
INSTITUTE OF SCIENCE & TECHNOLOGY
Bandlaguda Post, Keshavgiri, Hyderabad-500 005

Vysapuri, Bandlaguda Post:Keshavgirl,

MAHAVEER

INSTITUTE OF SCIENCE & TECHNOLOGY

Approved by AICTE, Affiliated to JNTUH,Hyd.



Hyderabad-500 005, TELANGANA INDIA
Tel: 040-64596979,8978380692,Fax: 040-24455003
E-mail: e3hod.it@gmail.com,
Website: www.mist.ac.in,

DEPARTMENT OF INFORMATION TECHNOLOGY

LIST OF REGISTERED STUDENTS FOR Java Certification programme

SNO	HALL TICKET NO	NAME OF THE STUDENT
1	14E31A1202	AREKATLA DIVYA
2	14E31A1204	B SAI KIRAN REDDY
3	14E31A1205	BANDHYALA AKSHAY REDDY
4	14E31A1206	DEVARANENI SRAVANI
5	14E31A1208	GANGIDI ANUSHA
6	14E31A1209	GANTE SANTHOSH
7	14E31A1210	GUJJA SAI AKHIL
8	14E31A1211	KAVETTI LALANI
9	14E31A1212	KORASIKA SAI KIRAN
10	14E31A1214	KURNAMONI DILIP
11	14E31A1215	MAHENDER SINGH
12	14E31A1216	MAMIDIPALEY MOUNIKA
13	14E31A1218	NALIMELA VINAY REDDY
14	14E31A1220	NARAGONI SHIVA VENKATA SAI
15	14E31A1221	PRANATHI PADAKANTI
16	14E31A1222	RAMA RAKESH
17	14E31A1223	RAMIDI KAVYA REDDY
18	14E31A1224	SREERAMINENI SRUJANA
19	14E31A1225	THIPPARAPU SRIVANI
20	14E31A1227	VEERAMREDDY MANASA
21	16E31A1202	ADURLA PAVAN
22	16E31A1203	AKULA PRANATHI
23	16E31A1204	ANDE NAVEEN KUMAR
24	16E31A1206	CHENNUPATI CHAITANYA
25	16E31A1207	CHIDIMILLA ASHWIDHI
26	16E31A1208	DEVARANENI SANJAY
27	16E31A1211	GOLI ARUN KUMAR
28	16E31A1212	KARING DINESH
29	16E31A1215	KEERTHI SAI KRISHNA
30	16E31A1214	KURUVA VAISHNAVI
31	16E31A1217	NANDIKANTI TEJASHWINI
32	16E31A1218	PADALA NAVIKANTH CHARY
33	16E31A1219	PAIPATI SHILPA REDDY
34	16E31A1220	PEDDISSETTY NAGA ANUSHA
35	16E31A1221	PERUMALLA KRANTHI KUMAR
36	16E31A1223	R VAISHNAVI
37	16E31A1224	SAMREEN SULTANA

Keshav
PRINCIPAL
MAHAVEER
INSTITUTE OF SCIENCE & TECHNOLOGY
Bandlaguda, Hyderabad-500 005.

Vysapuri, Bandlaguda Post, Keshavgiri,

Hyderabad-500 005, TELANGANA INDIA
Tel: 040-64596979, 8978380692, Fax: 040-24455003
E-mail: eshod.it@gmail.com,
Website: www.mist.ac.in,

MAHAVEER

INSTITUTE OF SCIENCE & TECHNOLOGY

Approved by AICTE, Affiliated to JNTUH, Hyd.



DEPARTMENT OF INFORMATION TECHNOLOGY

38	16E31A1225	SRIDHARA GAYATHRI
39	16E31A1227	THADIPARTHI THEJASWINI
40	16E31A1228	VADHADIYA SRINA
41	16E31A1229	VATTIKUTI MAHESH
42	16E31A1230	VITTEDI PAVAN REDDY
43	16E31A1231	YASA ABHINAYA

Head of Department
Department of Information Technology
Mahaveer Institute of Science & Technology
Bandlaguda Post, Keshavgiri
Hyderabad-500 005

Keshav
PRINCIPAL
MAHAVEER
INSTITUTE OF SCIENCE & TECHNOLOGY
Bandlaguda, Hyd-500 005

Vysapuri, Bandlaguda Post:Keshavgiri,

Hyderabad-500 005, TELANGANA INDIA
Tel: 040-64596979,8978380692,Fax: 040-24455003
E-mail: e3hod.it@gmail.com,
Website: www.mist.ac.in,

MAHAVEER

INSTITUTE OF SCIENCE & TECHNOLOGY

Approved by AICTE, Affiliated to JNTUH,Hyd.



DEPARTMENT OF INFORMATION TECHNOLOGY

Java Certification programme QUESTION PAPER

Duration: 120 Minutes

10 X 2 = 20 Marks

Answer the following all questions. Each question carries 2 marks.

- Q1. Explain JDK, JRE and JVM?
- Q2. Explain public static void main(String args[]) in Java
- Q3. Why Java is platform independent?
- Q4. Why Java is not 100% Object-oriented?
- Q5. What are wrapper classes in Java?
- Q6. What are constructors in Java?
- Q7. What is singleton class in Java and how can we make a class singleton?
- Q8. What is the difference between Array list and vector in Java?
- Q9. What is the difference between equals() and == in Java?
- Q10. What are the differences between Heap and Stack Memory in Java?

[Handwritten Signature]
HOD-IT

Head of Department
Department of Information Technology
Mahaveer Institute of Science & Technology
Bandlaguda, Hyderabad-500 005

[Handwritten Signature]
PRINCIPAL
MAHAVEER
INSTITUTE OF SCIENCE & TECHNOLOGY
Bandlaguda, Hyd-500 005.

Vysapuri, Bandlaguda Post, Keshavgirl,

Hyderabad-500 005, TELANGANA INDIA
Tel: 040-64596979, 8978380692, Fax: 040-24455003
E-mail: e3hod.it@gmail.com,
Website: www.mist.ac.in,

MAHAVEER

INSTITUTE OF SCIENCE & TECHNOLOGY

Approved by AICTE, Affiliated to JNTUH, Hyd.



DEPARTMENT OF INFORMATION TECHNOLOGY

RESULT SHEET FOR Java Certification programme REGISTERED STUDENTS

SNO	HALL TICKET NO	NAME OF THE STUDENT	MARKS (20)	RESULT
1	14E31A1202	AREKATLA DIVYA	20	PASS
2	14E31A1204	B SAI KIRAN REDDY	19	PASS
3	14E31A1205	BANDHYALA AKSHAY REDDY	20	PASS
4	14E31A1206	DEVARANENI SRAVANI	18	PASS
5	14E31A1208	GANGIDI ANUSHA	20	PASS
6	14E31A1209	GANTE SANTHOSH	20	PASS
7	14E31A1210	GUJJA SAI AKHIL	16	PASS
8	14E31A1211	KAVETTLALANI	20	PASS
9	14E31A1212	KORASIKA SAI KIRAN	20	PASS
10	14E31A1214	KURNAMONI DILIP	17	PASS
11	14E31A1215	MAHENDER SINGH	20	PASS
12	14E31A1216	MAMIDIPALEY MOUNIKA	20	PASS
13	14E31A1218	NALIMELA VINAY REDDY	16	PASS
14	14E31A1220	NARAGONI SHIVA VENKATA SAI	20	PASS
15	14E31A1221	FRANATHI PADAKANTI	20	PASS
16	14E31A1222	RAMA RAKESH	18	PASS
17	14E31A1223	RAMIDI KAVYA REDDY	20	PASS
18	14E31A1224	SREERAMINENI SRUJANA	19	PASS
19	14E31A1225	THIPPARAPU SRIVANI	20	PASS
20	14E31A1227	VEERAMREDDY MANASA	18	PASS
21	16E31A1202	ADURLA PAVAN	20	PASS
22	16E31A1203	AKULA PRANATHI	19	PASS
23	16E31A1204	ANDE NAVEEN KUMAR	20	PASS
24	16E31A1206	CHENNUPATI CHAIHANYA	18	PASS
25	16E31A1207	CHIDIMILLA ASHWIDHI	20	PASS
26	16E31A1208	DEVARANENI SANJAY	20	PASS
27	16E31A1211	GOLI ARUN KUMAR	16	PASS
28	16E31A1212	KARING DINESH	20	PASS
29	16E31A1213	KEERTHI SAI KRISHNA	20	PASS
30	16E31A1214	KURUVA VAISHNAVI	17	PASS
31	16E31A1217	NANDIKANTI TEJASHWINI	20	PASS
32	16E31A1218	PADALA NAVIKANTH CHARY	20	PASS
33	16E31A1219	PAIPATI SHILPA REDDY	16	PASS
34	16E31A1220	PEDDISETTY NAGA ANUSHA	20	PASS
35	16E31A1221	PERUMALLA KRANTHI KUMAR	20	PASS
36	16E31A1223	R VAISHNAVI	18	PASS
37	16E31A1224	SAMREEN SULTANA	20	PASS
38	16E31A1225	SRIDHARA GAYATHRI	19	PASS
39	16E31A1227	THADIPARTHI THEJASWINI	20	PASS

Kanthy
PRIYANKA
MAHAVEER
INSTITUTE OF SCIENCE & TECHNOLOGY
Bandlaguda, Hyd-500002

W. S. Purani, Bandlaguda Post: Keshavgi,
Hyderabad-500 005, TELANGANA INDIA
Tel: 040-64596979, 8978380692, Fax: 040-24455003
E-mail: e3hod.it@gmail.com,
Website: www.mist.ac.in,

MAHAVEER

INSTITUTE OF SCIENCE & TECHNOLOGY

Approved by AICTE, Affiliated to JNTUH, Hyd.



DEPARTMENT OF INFORMATION TECHNOLOGY

40	16E31A1228	VADHADIYA SRINA	18	PASS
41	16E31A1229	VATTIKUTI MAHESH	20	PASS
42	16E31A1230	VITTEDI PAVAN REDDY	20	PASS
43	16E31A1231	YASA ABHINAYA	16	PASS

No. of students Registered: 43

No. of students Passed: 43

No. of students failed: NIL

Principal
Department of Information Technology
Mahaveer Institute of Science & Technology
Bandlaguda, Hyderabad-500 005

K. Sankar
PRINCIPAL
MAHAVEER
INSTITUTE OF SCIENCE & TECHNOLOGY
Bandlaguda, Hyderabad-500 005

Vysapuri, Bandlaguda Post:Keshavgiri,

Hyderabad-500 005, TELANGANA INDIA

Tel: 040-64596979,8978380692 Fax: 040-24455003

E-mail: e3hod.it@gmail.com,

Website: www.mist.ac.in,

MAHAVEER

INSTITUTE OF SCIENCE & TECHNOLOGY

Approved by AICTE, Affiliated to JNTUH,Hyd.



DEPARTMENT OF INFORMATION TECHNOLOGY

SUMMARY REPORT OF Java Certification Programme

Java is one of the most popular programming languages used to create Web applications and platforms. It was designed for flexibility, allowing developers to write code that would run on any machine, regardless of architecture or platform.

Java is designed to be concurrent, class-based and object-oriented, as well as a computing platform first released by Sun Microsystems in 1995. An enormous amount of applications and websites will not work unless you have Java installed, and more are created every day.

Java is advertised, and esteemed for its fast performance, security, and reliability.

COORDINATOR

Copy to:

1. Department Notice Board
2. Principal for Information
3. Committee Members (Academic)

Kanish
PRINCIPAL
MAHAVEER
INSTITUTE OF SCIENCE & TECHNOLOGY
Bandlaguda, Hyderabad-500 005

Vysapuri, Bandlaguda Post:Keshavgiri,
Hyderabad-500 005, Telangana INDIA
Tel: 040-64596979,20020773, Fax: 040-24455003
E-mail: principal.mahaveer@gmail.com
Website: www.mist.ac.in,

MAHAVEER

INSTITUTE OF SCIENCE & TECHNOLOGY
Approved by AICTE, Affiliated to JNTUH,Hyd.



DEPARTMENT OF AERONAUTICAL ENGINEERING
PROPOSAL LETTER

Hyderabad,
16/08/2017.

To,
The principal,
MIST,
Hyderabad.

Sub: Proposal for two weeks workshop on Computer Aided Design CATIA - Intermediate

-Reg,

Dear Sir,

We are working as Asst professor in the department of AERONAUTICAL ENGINEERING.
Sir, we are going to conduct three weeks workshop Computer Aided Design CATIA - Intermediate. We require your approval to go head for further proceeding and hope to get an opportunity to serve you the best.

With thanks and Regards

K. Srinivas
PRINCIPAL
MAHAVEER
INSTITUTE OF SCIENCE & TECHNOLOGY
Bandlaguda, Hyd-500 005.

From,
AERO Department
Mist,
Bandlaguda,

A. Srinivas



DEPARTMENT OF AERONAUTICAL ENGINEERING

Date: 22.08.2017

CIRCULAR

Technical Training for III B. Tech students are starting from 22-08-2017 onwards. All HODs and Placements coordinators have to manage the trainings and ensure 95% attendance all through the sessions.

All Mentors need to send the compiled feedback report to A Ranga Reddy, HOD at e3hod.aero@gmail.com daily.

Agenda: 1. Computer Aided Design CATIA - Intermediate

Prof RANGAREDDY

HOD

Course Designed By

Y RAGHUVeer

G RAJESH KUMAR

Khandy
PRINCIPAL
MAHAVEER
INSTITUTE OF SCIENCE & TECHNOLOGY
Bandlaguda, Hyderabad-500 005.



SYLLABUS

Course: Computer Aided Design CATIA – Intermediate

1: Introduction to Catia V5

- Workbenches
- Toolbars
- Specification Tree
- Compass
- Mouse Usage
- File Operations

2: Drawing Sketches in the Sketcher

- Workbench-I Invoking the Sketcher Workbench
- Units, Grid Settings
- Construction and Standard elements
- Drawing Sketch objects I
- Inferred Constraints
- Exiting the Sketcher Workbench
- View Manipulation
- Chapter 2 Tutorials 1-3 Assignment

3: Drawing Sketches in the Sketcher

- Workbench-II Drawing Sketch Objects II
- Modifying sketch Objects
- Sketch Transformations
- Chapter 3 Tutorials 1-3, Exercise 1 Assignment

4: Constraining Sketches and Creating Base Features

- Constraining Sketches
- Geometric Constraints
- Dimensional Constraints



- Sketch Analysis
- Creating an Extruded Solid Using the Pad Feature
- Creating a Revolved Solid Using the Shaft Feature

5: Reference Elements and Sketch-Based Features

- Reference Elements
- Drafted Filleted Pad Features
- Multi-Pad Features
- Pocket Features
- Drafted Filleted Pocket
- Multi-Pocket Features
- Groove
- Extruding and Revolving Faces
- Projecting 3D Elements
- Chapter 5 Tutorial 1-3 Assignment

K. Srinivas

PRINCIPAL
MAHAVEER
INSTITUTE OF SCIENCE & TECHNOLOGY
Bandlaguda, Hyderabad-500 005.



Computer Aided Design CATIA Course

STUDENT LIST 2017-18

S.No	Hall Ticket No	Name of the Candidate	YEAR
1	15E31A2101	AARE BHARATH REDDY	III
2	15E31A2102	BANDI PRIYANKA	III
3	15E31A2104	BHOOMOLLA DHRUVA KUMAR GOUD	III
4	15E31A2105	CHILIVERU PRANAY	III
5	15E31A2108	DEVARAKONDA PURNACHANDER	III
6	15E31A2109	LONKA VAMSHI KRISHNA	III
7	15E31A2110	MALA HARICHANDAN	III
8	15E31A2111	MOODU RAJKUMAR	III
9	15E31A2112	N SRAVAN KUMAR	III
10	15E31A2114	NIDHI SINGH	III
11	15E31A2115	PANJAGUTTA PRIYANKA	III
12	15E31A2117	SAMALA MANISH	III
13	15E31A2119	VAJRAPU NARESH	III
14	15E31A2120	ZAMAN KHAN	III
15	15E31A2121	YARLAGADDA BHARAT TEJ	III
16	16E35A2101	SETTI SAI GOPI KRISHNA	III

K. Sankar
PRINCIPAL
MAHAVEER
INSTITUTE OF ENGINEERING & TECHNOLOGY
Bandlaguda, Hyderabad

S. Sankar

HOD



Technical Training Exam on Computer Aided Design CATIA Software (A.Y-2017-18)

2x10=20 Marks

Answer All the Questions

1. Draw the given 2D model into 3D model by using CATIA

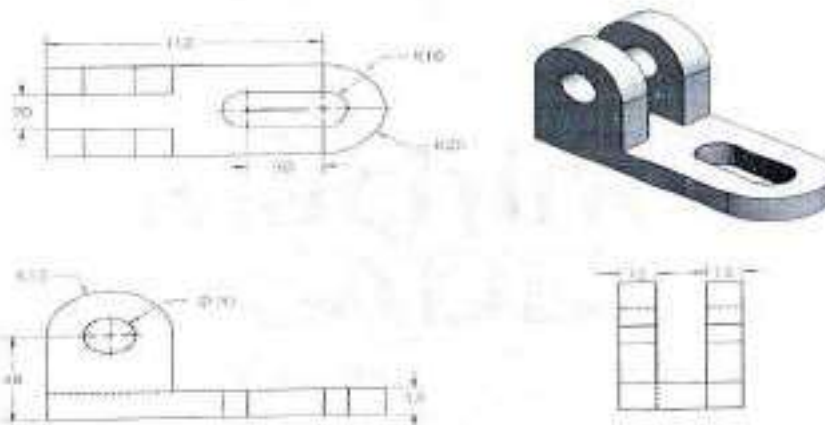

2. Draw the given 2D model into 3D model by using Auto CAD,

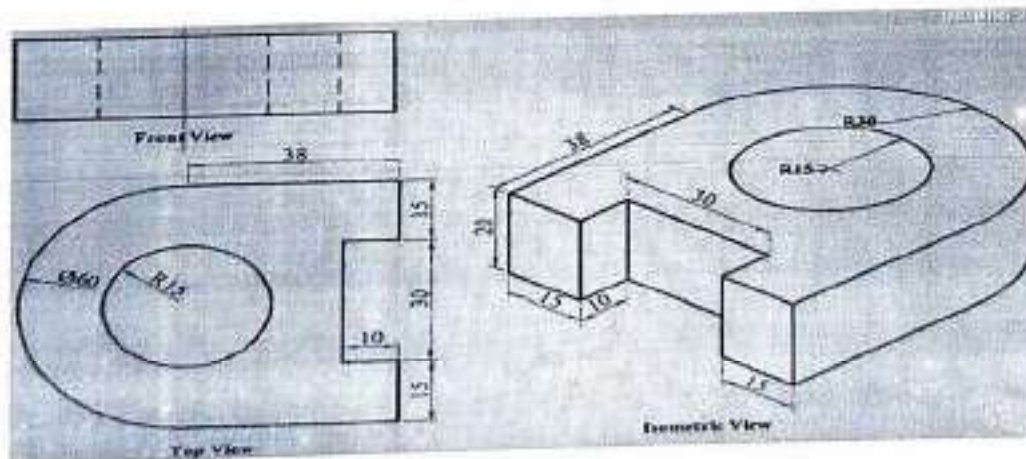



Computer Aided Design CATIA Course

Training student marks list 2017-18

S.No	Hall Ticket No	Name of the Candidate	marks	Pass/
1	15E31A2101	AARE BHARATH REDDY	16	PASS
2	15E31A2102	BANDI PRIYANKA	15	PASS
3	15E31A2104	BHOOMOLLA DHRUVA KUMAR GOUD	16	PASS
4	15E31A2105	CHILIVERU PRANAY	17	PASS
5	15E31A2108	DEVARAKONDA PURNACHANDER	15	PASS
6	15E31A2109	LONKA VAMSHI KRISHNA	16	PASS
7	15E31A2110	MALA HARICHANDAN	18	PASS
8	15E31A2111	MOODU RAJKUMAR	19	PASS
9	15E31A2112	N SRAVAN KUMAR	18	PASS
10	15E31A2114	NIDHI SINGH	17	PASS
11	15E31A2115	PANJAGUTTA PRIYANKA	20	PASS
12	15E31A2117	SAMALA MANISH	17	PASS
13	15E31A2119	VAJRAPU NARESH	15	PASS
14	15E31A2120	ZAMAN KHAN	16	PASS
15	15E31A2121	YARLAGADDA BHARAT TEJ	17	PASS
16	16E35A2101	SETTI SAI GOPI KRISHNA	15	PASS

K. Srinivas
PRINCIPAL
MAHAVEER
INSTITUTE OF SCIENCE & TECHNOLOGY
Vysapuri, Bandlaguda Post, Keshavgiri,
Hyderabad-500 005, Telangana INDIA

S. Somnath
HOD

MAHAVER INSTITUTE OF SCIENCE AND TECHNOLOGY
AERONAUTICAL ENGINEERING
COURSE ATTENDANCE LIST

S NO	HT NO	NAME	Date	21	22	23	24	25	26	27	28	29	30	31	-	5	6
1	15E31A2101	AJRE BHARATH REDDY		P	P	P	P	P	P	P	P	P	P	P	P	P	P
2	15E31A2102	BANDI PRIYANKA		P	P	P	P	P	P	P	P	P	P	P	P	P	P
3	15E31A2104	BHOJIMOLLA DHRUVA KUMAR GOUD		P	P	P	P	P	P	P	P	P	P	P	P	P	P
4	15E31A2105	CHILIVERU PRANAV		P	P	P	P	P	P	P	P	P	P	P	P	P	P
5	15E31A2108	DEVARAKONDA PURNACHANDER		P	P	P	P	P	P	P	P	P	P	P	P	P	P
6	15E31A2109	LONKA VAMSHI KRISHNA		P	P	P	P	P	P	P	P	P	P	P	P	P	P
7	15E31A2110	MALA HARICHANDAN		P	P	P	P	P	P	P	P	P	P	P	P	P	P
8	15E31A2111	MOKKOU RAJKUMAR		P	P	P	P	P	P	P	P	P	P	P	P	P	P
9	15E31A2112	N SRAVAN KUMAR		P	P	P	P	P	P	P	P	P	P	P	P	P	P
10	15E31A2114	NIDHI SINGH		P	P	P	P	P	P	P	P	P	P	P	P	P	P
11	15E31A2115	PANGAGUTTA PRIYANKA		P	P	P	P	P	P	P	P	P	P	P	P	P	P
12	15E31A2117	SAMALA MANISH		P	P	P	P	P	P	P	P	P	P	P	P	P	P
13	15E31A2119	VAIKAPU NARESH		P	P	P	P	P	P	P	P	P	P	P	P	P	P
14	15E31A2120	ZANAN KHAM		P	P	P	P	P	P	P	P	P	P	P	P	P	P
15	15E31A2171	YARLAGADDA BHARAT TEJ		P	P	P	P	P	P	P	P	P	P	P	P	P	P
16	16E35A2101	SETTI SAI GOPI KRISHNA		P	P	P	P	P	P	P	P	P	P	P	P	P	P

A. Annamalai
HOD

16/06/23
PRINCIPAL
MAHAVER
INSTITUTE OF SCIENCE & TECHNOLOGY
WARRANGAL, TELANGANA



Course: Computer Aided Design CATIA – Intermediate

SUMMARY REPORT

CATIA Training. Computer Aided Design (CAD) is the use of computer software to design a product or an object. Computer Aided Engineering is the use of computer software to solve engineering problems and analyze products created using CAD. CATIA is an acronym for Computer Aided Three-dimensional Interactive Application

Overview: The Wireframe and Surface course is designed to teach you the basic wireframe and surface commands in CATIA V5-6 R2012. You more. We will learn how to create lines, points and planes in 3D space. You'll also learn how to create extruded and revolved surfaces from wireframe geometry and sketches.

A. Adornachey
HOD

K. K. K.
PRINCIPAL
MAHAVEER
INSTITUTE OF SCIENCE & TECHNOLOGY
VYESAPURI, BANDLAGUDA POST, KESHAVGI, HYDERABAD-500 005, TELANGANA INDIA

Vysapuri, Bandlaguda Post:Keshavgiri,
Hyderabad-500 005, Telangana INDIA
Tel: 040-64596979,20020773, Fax: 040-24455003
E-mail: principal.mahaveer@gmail.com
Website: www.mist.ac.in

MAHAVEER

INSTITUTE OF SCIENCE & TECHNOLOGY
Approved by AICTE, Affiliated to JNTUHHyd.



CERTIFICATE OF COURSE COMPLETION

This certificate is presented to BANDI PRIYANKA of MIST, who has successfully completed technical training course on "Computer Aided Design CATIA - Intermediate" held from 22-08-2017 to 06-09-2017 and found the student performance to be excellent.



A. Ranga Reddy

A RANGA REDDY
HOD (AERO)

K. Srinivas
PRINCIPAL
MAHAVEER
INSTITUTE OF SCIENCE & TECHNOLOGY
Bandlaguda, Vysapuri, Hyderabad

Vysapuri, Bandlaguda Post:Keshavgi,

Hyderabad-500 005, TELANGANA INDIA
Tel: 040-64596979,8978380692,Fax: 040-24455003
E-mail: e3hod.it@gmail.com,
Website: www.mist.ac.in,

MAHAVEER
INSTITUTE OF SCIENCE & TECHNOLOGY
Approved by AICTE, Affiliated to JNTUH,Hyd.



DEPARTMENT OF HUMANITIES AND SCIENCES

Date: 20-09-17

To,
The principal,
MIST ,
Hyderabad.

Sub: Proposal for Add-on-course-Reg
Dear sir,

We are going to conduct Add-On course on Ultrasonics. we require your approval to go head for further proceeding and hope to get an opportunity to serve you the best.

With thanks and Regards

PRINCIPAL
MAHAVEER
INSTITUTE OF SCIENCE & TECHNOLOGY
Bandlaguda, Hyd-500 005.

HOD
Department of Humanities & Sciences
Mahaveer Institute of Science & Technology,
HYDERABAD

Vysapuri, Bandlaguda Post:Keshavgiri,

Hyderabad-500 005, TELANGANA INDIA
Tel: 040-64596979,8978380692,Fax: 040-24455003
E-mail: e3hod.it@gmail.com,
Website: www.mist.ac.in,

MAHAVEER
INSTITUTE OF SCIENCE & TECHNOLOGY
Approved by AICTE, Affiliated to JNTUH,Hyd.



DEPARTMENT OF HUMANITIES AND SCIENCES

Date: 25-09-17

CIRCULAR

CRASH COURSE FOR I B.Tech students are starting from 27-09-17 onwards. All HODs and placements coordinators have to manage the trainings and ensure 95% attendance all through the sessions.

All mentors need to send the compiled feedback report to HOD at e3hod@gmail.com daily. Mentors are advised to take care of PNR (Students not participating in training).

Agenda: **ULTRASONICS**

Design and Development of Curriculum for Add on Course

Name of Faculty: 1.Dr.K.MADHUSUDHANA
2.P.SRINIVAS KUMAR



PRINCIPAL
MAHAVEER
INSTITUTE OF SCIENCE & TECHNOLOGY
Bandlaguda, Hyd-500 005.

HOD
Department of Humanities & Sciences
Mahaveer Institute of Science & Technology,
HYDERABAD

Vysapuri, Bandlaguda Post:Keshavgiri,

Hyderabad-500 005, TELANGANA INDIA
Tel: 040-64596979,8978380692,Fax: 040-24455003
E-mail: e3hod.it@gmail.com,
Website: www.mist.ac.in,

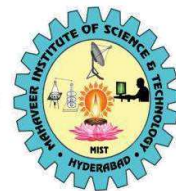
MAHAVEER
INSTITUTE OF SCIENCE & TECHNOLOGY
Approved by AICTE, Affiliated to JNTUH,Hyd.



DEPARTMENT OF HUMANITIES AND SCIENCES

SYLLABUS FOR ULTRASONICS

SNO	TOPIC COVERED	DURATION
1	Introduction, Fundamentals of Ultrasonics	3
2	Features of Ultrasonic waves	3
3	Generation of Ultrasonics waves	3
4	Detection of Ultrasonic waves	3
5	Cavitations	3
6	Determination of velocity in a Liquid	3
7	Determination of velocity in Solids	3
8	Applications of Ultrasonics: Industrial, Medical, Marine	3

PRINCIPAL
MAHAVEER
INSTITUTE OF SCIENCE & TECHNOLOGY
Bandlaguda, Hyd-500 005.

HOD
Department of Humanities & Sciences
Mahaveer Institute of Science & Technology,
HYDERABAD

Vysapuri, Bandlaguda Post:Keshavgi,

Hyderabad-500 005, TELANGANA INDIA
Tel: 040-64596979,8978380692,Fax: 040-24455003
E-mail: e3hod.it@gmail.com,
Website: www.mist.ac.in,

MAHAVEER
INSTITUTE OF SCIENCE & TECHNOLOGY
Approved by AICTE, Affiliated to JNTUH,Hyd.

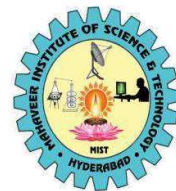

DEPARTMENT OF HUMANITIES AND SCIENCES

LIST OF REGISTERED STUDENTENS FOR ULTRASONICS

SNO	HOLL TICKET NO	NAME OF THE STUDENT
1	17E31A0406	ARAVIND JOSHI
2	17E31A0411	BOORAM SAI ROSHAN
3	17E31A0416	CHIRLA AKHILA
4	17E31A0438	KATTAGURI SHIVANI
5	17E31A0465	V RAHUL
6	17E31A0466	VEMULA AVINASH
7	17E31A0468	VISLAVATH SHIVA
8	17E31A0207	CHIDUMULA APARNA
9	17E31A0214	KATAKAM GOPI
10	17E31A0225	SYED ZAFAR
11	17E31A0228	V SWATHI
12	17E31A1207	C PRASHANSHA
13	17E31A1230	SAMA NAVYA
14	17E31A0508	CHELLOJU ANUSHA
15	17E31A0518	JAMADANDA MANISH
16	17E31A0528	LONE HARISH
17	17E31A0548	THUKKANI SHREYA
18	17E31A0105	BHUKYA RAJU
19	17E31A0114	ESSAM KAVYA
20	17E31A0304	BANGARI MOHAN
21	17E31A0315	JARPLA SANDEEP
22	17E31A0324	MALLETHULA RAHUL
23	17E31A2108	G SRIKANTH
24	17E31A2116	KUDIKALA ANOSH
25	17E31A2127	SAMBARU VIKAS

Kanish

PRINCIPAL
MAHAVEER
INSTITUTE OF SCIENCE & TECHNOLOGY
Bandlaguda, Hyd-500 005.

Vysapuri, Bandlaguda Post:Keshavgiri,

Hyderabad-500 005, TELANGANA INDIA
Tel: 040-64596979,8978380692,Fax: 040-24455003
E-mail: e3hod.it@gmail.com,
Website: www.mist.ac.in,

MAHAVEER
INSTITUTE OF SCIENCE & TECHNOLOGY
Approved by AICTE, Affiliated to JNTUH,Hyd.



DEPARTMENT OF HUMANITIES AND SCIENCES

ULTRASONICS QUESTION PAPER

DURATION:120 MINUTES

MAX.MARKS 50

PART-A

ANSWER ANY TWO QUESTION.

2*15=30

- 1.EXPLAIN GENERATION OF ULTRASONICS?
- 2.EXPLAIN DETECTION OF ULTRA SONICS?
- 3.DISCUSS DIFFERENT METHODS TO FIND VELOCITY OF ULTRASONICS?

PART-B

ANSWER ANY TWO QUESTION.

2*10=20

- 4.DISCUSS APPLICATIONS OF ULTRASONICS?
- 5.EXPLAIN PULSE ECHO OVERLOP TECHUNIQUE?
6. WRITE THE DIFFRENCES BETWEEN ULTRASONICS AND SOWD

Keshav
PRINCIPAL
MAHAVEER
INSTITUTE OF SCIENCE & TECHNOLOGY
Bandlaguda, Hyd-500 005.

Vysapuri, Bandlaguda Post:Keshavgiri,

Hyderabad-500 005, TELANGANA INDIA
Tel: 040-64596979,8978380692,Fax: 040-24455003
E-mail: e3hod.it@gmail.com,
Website: www.mist.ac.in,

MAHAVEER
INSTITUTE OF SCIENCE & TECHNOLOGY
Approved by AICTE, Affiliated to JNTUH,Hyd.



DEPARTMENT OF HUMANITIES AND SCIENCES

RESULT SHEET FOR ULTRASONICS REGISTERED STUDENTS

SNO	HOLL TICKET NO	NAME OF THE STUDENT	MARKS(20)	RESULT
1	17E31A0406	ARAVIND JOSHI	20	PASS
2	17E31A0411	BOORAM SAI ROSHAN	19	PASS
3	17E31A0416	CHIRLA AKHILA	20	PASS
4	17E31A0438	KATTAGURI SHIVANI	18	PASS
5	17E31A0465	V RAHUL	20	PASS
6	17E31A0466	VEMULA AVINASH	19	PASS
7	17E31A0468	VISLAVATH SHIVA	18	PASS
8	17E31A0207	CHIDUMULA APARNA	20	PASS
9	17E31A0214	KATAKAM GOPI	18	PASS
10	17E31A0225	SYED ZAFAR	18	PASS
11	17E31A0228	V SWATHI	19	PASS
12	17E31A1207	C PRASHANSHA	19	PASS
13	17E31A1230	SAMA NAVYA	20	PASS
14	17E31A0508	CHELLOJU ANUSHA	20	PASS
15	17E31A0518	JAMADANDA MANISH	20	PASS
16	17E31A0528	LONE HARISH	19	PASS
17	17E31A0548	THUKKANI SHREYA	19	PASS
18	17E31A0105	BHUKYA RAJU	18	PASS
19	17E31A0114	ESSAM KAVYA	18	PASS
20	17E31A0304	BANGARI MOHAN	20	PASS
21	17E31A0315	JARPLA SANDEEP	18	PASS
22	17E31A0324	MALLETHULA RAHUL	17	PASS
23	17E31A2108	G SRIKANTH	16	PASS
24	17E31A2116	KUDIKALA ANOSH	20	PASS
25	17E31A2127	SAMBARU VIKAS	19	PASS

No.of students registred:20

No.of students passed :20

No.of students failed :Nil

PRINCIPAL
MAHAVEER
INSTITUTE OF SCIENCE & TECHNOLOGY
Bandlaguda, Hyd-500 005.

HOD
Department of Humanities & Sciences
Mahaveer Institute of Science & Technology,
HYDERABAD

Vysapuri, Bandlaguda Post:Keshavgiri,

Hyderabad-500 005, TELANGANA INDIA
Tel: 040-64596979,8978380692,Fax: 040-24455003
E-mail: e3hod.it@gmail.com,
Website: www.mist.ac.in,

MAHAVEER
INSTITUTE OF SCIENCE & TECHNOLOGY
Approved by AICTE, Affiliated to JNTUH,Hyd.



DEPARTMENT OF HUMANITIES AND SCIENCES

SUMMARY REPORT OF ULTRASONICS

Ultrasonics, Vibrational or stress waves in elastic media that have a frequency above 20 kilohertz, the highest frequency of sound waves that can be detected by the human ear. They can be generated or detected by piezoelectric transducers (*see* piezoelectricity). High-power ultrasonics produce distortion in a medium; applications include ultrasonic welding, drilling, irradiation of fluid suspensions (as in wine clarification), cleaning of surfaces (such as jewelry), and disruption of biological structures. Low-power ultrasonic waves do not cause distortions; uses include sonar, structure testing, and medical imaging and diagnosis. Some animals, including [bats](#), employ ultrasonic echolocation for navigation.

COPY TO:

- 1.Department notice board.
- 2.Principal for information
- 3.committee members (academic)

PRINCIPAL
MAHAVEER
INSTITUTE OF SCIENCE & TECHNOLOGY
Bandlaguda, Hyd-500 005.

MAHAVEER INSTITUTE OF SCIENCE & TECHNOLOGY
DEPARTMENT OF HUMANITIES AND SCIENCE
ULTRASONICS ATTENDANCE SHEET

S.NO	HT NO	NAME OF THE STUDENT	1	2	3	4	5	6	7	8	9	10	11	12	13	14	15	16	17	18	19	20
1	17E31A0406	ARAVIND JOSHI	P	P	P	P	P	P	A	P	P	P	P	P	P	P	A	P	P	P	P	P
2	17E31A0411	BOORAM SAI ROSHAN	P	P	P	A	P	P	P	P	P	P	P	P	P	P	A	P	P	P	P	P
3	17E31A0416	CHIRLA AKHILA	P	P	P	P	P	P	A	P	P	P	P	P	P	P	A	P	P	P	P	P
4	17E31A0438	KATTAGURI SHIVANI	P	P	P	P	P	P	A	P	P	P	P	P	P	P	A	P	P	P	P	P
5	17E31A0465	V RAHUL	P	P	P	P	P	P	P	A	P	P	P	P	P	P	A	P	P	P	P	P
6	17E31A0469	VENULA AVINASH	P	P	P	P	P	P	P	A	P	P	P	P	P	P	A	P	P	P	P	P
7	17E31A0468	VISLAVATH SHIVA	P	P	P	P	P	P	P	P	P	P	P	P	P	P	A	P	P	P	P	P
8	17E31A0207	CHIDUMULA APARNA	P	P	P	P	P	P	A	P	P	P	P	P	P	P	A	P	P	P	P	P
9	17E31A0214	KATAKAM GOPI	P	P	P	P	P	P	A	P	P	P	P	P	P	P	A	P	P	P	P	P
10	17E31A0225	SYED ZAFAR	P	P	P	P	P	P	P	A	P	P	P	P	P	P	A	P	P	P	P	P
11	17E31A0228	V SWATHI	P	P	P	P	P	P	P	P	P	P	P	P	P	P	A	P	P	P	P	P
12	17E31A1207	C. PRASHANSHA	P	P	P	P	P	P	P	P	P	P	P	P	P	P	A	P	P	P	P	P
13	17E31A1239	SAMA NAVYA	P	P	P	P	P	P	P	P	P	P	P	P	P	P	A	P	P	P	P	P
14	17E31A0508	CHELLOJU ANUSHA	P	P	P	P	P	P	P	P	P	P	P	P	P	P	A	P	P	P	P	P
15	17E31A0518	JAMADANDA MANISH	P	P	P	P	P	P	P	P	P	P	P	P	P	P	A	P	P	P	P	P
16	17E31A0528	LONE HARISH	P	P	P	P	P	P	P	P	P	P	P	P	P	P	A	P	P	P	P	P
17	17E31A0548	THUKKANI SHREYA	P	P	P	P	P	P	P	P	P	P	P	P	P	P	A	P	P	P	P	P
18	17E31A0105	BHUKYA RAJU	P	P	P	P	P	P	P	P	P	P	P	P	P	P	A	P	P	P	P	P
19	17E31A0134	ESSAM KAVYA	P	P	P	P	P	P	P	P	P	P	P	P	P	P	A	P	P	P	P	P
20	17E31A0304	BANGARI MOHAN	P	P	P	P	P	P	P	P	P	P	P	P	P	P	A	P	P	P	P	P
21	17E31A0315	JARPLA SANDEEP	P	P	P	P	P	P	P	P	P	P	P	P	P	P	A	P	P	P	P	P
22	17E31A0324	MALLETHULA RAHUL	P	P	P	P	P	P	P	P	P	P	P	P	P	P	A	P	P	P	P	P
23	17E31A2108	G SRIKANTH	P	P	P	P	P	P	P	P	P	P	P	P	P	P	A	P	P	P	P	P
24	17E31A2136	KUDIKALA ANOSH	P	P	P	P	P	P	P	P	P	P	P	P	P	P	A	P	P	P	P	P
25	17E31A2127	SAMBARU VIKAS	P	P	P	P	P	P	P	P	P	P	P	P	P	P	A	P	P	P	P	P

M Ratibha

HOD
 Department of Humanities & Science
 Mahaveer Institute of Science & Technology
 HYDERABAD

**MAHAVEER INSTITUTE OF
SCIENCE AND TECHNOLOGY**
APPROVED BY AICTE AFFILIATED TO JNTUH - HYD.
DEPARTMENT OF
HUMANITIES AND SCIENCES



Certificate

This is to certify that Mr/Ms V Rahul _____
bearing Hall Ticket No 17E31A0465 of B.Tech First Year
has participated In Certificate course on **ULTRASONICS**
From 26-10-17 to 18-11-17 organized by Dept. of
Humanities and Sciences

M. Ratika
NOD
Department of Humanities and Sciences
Mahaveer Institute of Science and Technology
Hyderabad

K. Kalyan
PRINCIPAL
MAHAVEER
INSTITUTE OF SCIENCE AND TECHNOLOGY
HYDERABAD, TELANGANA

Vysapuri, Bandlaguda Post:Keshavgirl,
Hyderabad-500 005, Telangana INDIA
Tel: 040-64596979,20020773, Fax: 040-24455003
E-mail: principal.mahaveer@gmail.com,
Website: www.mist.ac.in,

MAHAVEER
INSTITUTE OF SCIENCE & TECHNOLOGY
Approved by AICTE, Affiliated to JNTUH,Hyd.



PROPOSAL LETTER

Hyderabad,

25/07/2018.

To,
The principal,
MIST,
Hyderabad.

Sub: Proposal for two weeks workshop on AUTO CAD-Reg,

Dear Sir,

We are working as asst professor in the department of CIVIL ENGINEERING. Sir, we are going to conduct two weeks workshop on AUTO CAD. We require your approval to go head for further proceeding and hope to get an opportunity to serve you the best .

With thanks and Regards



Khanif
PRINCIPAL
MAHAVEER
INSTITUTE OF SCIENCE & TECHNOLOGY

From,
Civil Department
Mist,
Bandlaguda,
Hyderabad.



Date: 30.07.2018

CIRCULAR

Technical Training for II B. Tech students are starting from 6th Aug, 2018 onwards. All HODs and Placements coordinators have to manage the trainings and ensure 95% attendance all through the sessions.

All Mentors need to send the compiled feedback report to CH Swethamber, HOD at c3hod.civil@gmail.com daily.

Agenda: 1. Introduction to AUTOCAD.

Designed by: B RAMANA KUMAR



Ch. Swethamber
HOD

B Ramana Kumar

PRINCIPAL
MAHAVEER
INSTITUTE OF SCIENCE & TECHNOLOGY
Bandlaguda, Hyderabad-500005



Auto CAD SYLLABUS

1: Getting Started with AutoCAD

- Opening and Creating Drawings
- Exploring the AutoCAD interface
- Zooming and Panning

2: Basic Drawing & Editing Commands

- Using the Mouse, Keyboard, and Enter Key to work quickly and efficiently in AutoCAD
- Lines
- Circles
- Rectangles

3: Projects - Creating a Simple Drawing

- Creating Simple Drawings
- Using Object Snap Tracking to extrapolate a projected top view
- Using Modify tools to arrange an office layout

4: Drawing Precision in AutoCAD

- Polar and Ortho Tracking
- Entering Coordinates and Angles
- Object Snaps and Tracking

5: Making Changes in Your Drawing

- Move
- Copy
- Rotate
- Mirror
- Scale
- Using the reference option with the Scale Tool

7: Organizing Your Drawing with Layers

- Layer States
- Properties by Layer
- Layer Tools

8: Advanced Object Types

Kishu

PRINCIPAL
MAHAVEER
INSTITUTE OF SCIENCE & TECHNOLOGY
Bandlaguda, Hyd-500 005.



- Polylines
- Arcs
- Polygons
- Ellipses

9: Advanced Editing Commands

- Trim and Extend
- Fillet and Chamfer
- Polyline Edit and Spline
- Offset and Explode
- Join

10: Inserting Blocks

- The Insert Block Command
- Inserting Blocks with Tool Palettes
- Dynamic Blocs
- Migrating Blocks and other Elements between Drawings with Design Center

11: Text

- The Multiline Text Tool
- The Single Line Text Tool
- Editing Text
- Text in Model Space vs. Paper Space
- The Multileader Tool

12: Hatching

- The Hatch Command
- The Hatch Editor Ribbon Tab
- Saving and Applying Hatches with Tool Palettes

13: Adding Dimensions

- Using Dimensioning Tools
- Dimensioning in a Layout Tab vs. the Model Tab
- Using Dimension Styles
- Editing Dimensions

14. Projects - Annotating Your Drawing

- Dimensioning a Mechanical Drawing

Khan

**PRINCIPAL
MAHAVEER**
INSTITUTE OF SCIENCE & TECHNOLOGY
Bawdigauda, mysr-500 095.



Vysapuri, Bandlaguda Post:Keshavgiri,
Hyderabad-500 905, Telangana INDIA
Tel: 040-64896979,20020773, Fax: 040-24455003
E-mail: principal.mahaveer@gmail.com,
Website: www.mist.ac.in,

MAHAVEER

INSTITUTE OF SCIENCE & TECHNOLOGY
Approved by AICTE, Affiliated to JNTUH,Hyd.



Department of Civil Engineering Auto CAD Technical Training student attendance list 2018-19

S.No	Hall Ticket No	Name of the Candidate	Year
1	17E31A0101	ANNALDAS JANAKI	II
2	17E31A0102	ARSHI FIRDAUSH	II
3	17E31A0103	B SOHAN LAL	II
4	17E31A0105	BHUKYA RAJU	II
5	17E31A0106	BHUKYA RAVIKUMAR	II
6	17E31A0107	BOLLAM VIJAY KUMAR	II
7	17E31A0108	CHELUMALLA VIKAS REDDY	II
8	17E31A0109	CHIENNAKESHI MANIKANTA MUDHIRAJ	II
9	17E31A0110	D TEJA	II
10	17E31A0113	DEVALLA SMARANI	II
11	17E31A0114	ESSAM KAVYA	II
12	17E31A0116	HALAVATHI HARI KRISHNA	II
13	17E31A0121	M A GHANIUDDIN	II
14	17E31A0122	MADDELA ARUN KUMAR	II
15	17E31A0125	MOHAMMED MUQTAR PATEL	II
16	17E31A0128	MOHD MAJEED UDDIN	II



K. S. S. S.
PRINCIPAL
MAHAVEER

Department of Science & Technology
Bandlaguda, Hyderabad-500 905

17	17E31A0135	PAKALA SAI PRASAD	II
18	17E31A0138	SHARAVATH SREEDHER	II
19	17E31A0139	SHIVARATRI KUMAR	II
20	17E31A0140	SIDDAMSETTI AVINASHI	II
21	17E31A0141	SK REHMATIBABA	II
22	17E31A0142	SUNKARA HARSHAVARDHAN	II
23	17E31A0143	TURUKA PAVANI	II
24	17E31A0144	YATHAM SAI YASHAWINI	II
25	18E35A0101	ADNAN ABDUL WASE	II
26	18E35A0102	BADALA VARA PRASAD	II
27	18E35A0103	BHOOKYA DHILIP	II
28	18E35A0104	DHANAVATHI NAGA	II
29	18E35A0105	DONTIARABOINA KIRAN KUMAR	II
30	18E35A0106	KOLLA KRANTHI KUMAR	II
31	18E35A0107	MANKA TUSHAL YADAV	II
32	18E35A0108	MERUGU ROHITHI	II
33	18E35A0109	MULLUKUNTLA MOUNIKA	II
34	18E35A0110	POCHAGARI ALOK	II
35	18E35A0111	P DEEPA SREE	II
36	18E35A0112	P RAGHAVENDAR	II
37	18E35A0113	SANDADI TEJASWINI	II
38	18E35A0114	VENU GOPAL	II

PRINCIPAL
MANAVEER
 INSTITUTE OF SCIENCE & TECHNOLOGY
 Bangalore, Karnataka - 560 075



MAHAVEER INSTITUTE OF SCIENCE & TECHNOLOGY, HYDERABAD
CIVIL ENGINEERING STUDENTS ATTENDANCE

REG. CHIT. DATE: 15/08/2019 BATCH: 14 Date: 14.08.2019 to 17.08.2019

S.No	Roll Number	Name of the Candidate	1	2	3	4	5	6	7	8	9	10
1	17E15A0101	ANNAL DAS JAYANI	P	P	P	P	P	P	P	P	P	P
2	17E15A0102	ARSHI HIRANISHI	A	P	P	P	P	P	P	P	P	P
3	17E15A0103	ANJAN LAL	P	P	P	P	P	P	P	P	P	P
4	17E15A0104	ABHIR VASUDEV	P	P	P	P	P	P	P	P	P	P
5	17E15A0105	RIHANYA RAVIKUMAR	P	P	P	P	P	P	P	P	P	P
6	17E15A0106	PRITAM VIKAS KUMAR	P	P	P	P	P	P	P	P	P	P
7	17E15A0107	HELINATHA VIKAS KUMAR	P	P	P	P	P	P	P	P	P	P
8	17E15A0108	CHINMAY SHIVAN ANITA MADHURAJ	P	P	P	P	P	P	P	P	P	P
9	17E15A0109	UJDA	P	P	P	P	P	P	P	P	P	P
10	17E15A0110	DEVATHA SWARANI	P	P	P	P	P	P	P	P	P	P
11	17E15A0111	ISSAMI KANYA	P	P	P	P	P	P	P	P	P	P
12	17E15A0116	ANAVATHI HARI KISHORA	P	P	P	P	P	P	P	P	P	P
13	17E15A0121	MAHESH KISHOR	P	P	P	P	P	P	P	P	P	P
14	17E15A0122	ADARSH ABHIR KUMAR	P	P	P	P	P	P	P	P	P	P
15	17E15A0124	MURARAJ SHARAD RAJESH	P	P	P	P	P	P	P	P	P	P
16	17E15A0128	SRINIVAS RUDRAN	P	P	P	P	P	P	P	P	P	P
17	17E15A0129	PAKATI SATHISHANAND	P	P	P	P	P	P	P	P	P	P
18	17E15A0129	SILARAVATHI SRITHIRER	P	P	P	P	P	P	P	P	P	P
19	17E15A0129	SIVARAJA KISHOR	P	P	P	P	P	P	P	P	P	P
20	17E15A0130	SIDDHANTH AVINASH	P	P	P	P	P	P	P	P	P	P
21	17E15A0141	SEELINATH RAO	P	P	P	P	P	P	P	P	P	P
22	17E15A0142	SINIKARA HARISHANKAR	P	P	P	P	P	P	P	P	P	P
23	17E15A0142	HARISHANKAR	P	P	P	P	P	P	P	P	P	P
24	17E15A0144	VAIDHANA YASHWANTHI	P	P	P	P	P	P	P	P	P	P
25	17E15A0147	ANAN ABHIR WASE	P	P	P	P	P	P	P	P	P	P
26	17E15A0102	KALANJAYAS PRASAD	P	P	P	P	P	P	P	P	P	P
27	17E15A0103	HIRORAYA DHRUP	P	P	P	P	P	P	P	P	P	P
28	17E15A0104	TRIVANAYATHI NAGA	P	P	P	P	P	P	P	P	P	P
29	17E15A0105	DRONATHARAJAN KISHOR	P	P	P	P	P	P	P	P	P	P
30	17E15A0106	KOJIA KARANJITH KISHOR	P	P	P	P	P	P	P	P	P	P
31	17E15A0107	MAANIKA TEJASWINI YADAV	P	P	P	P	P	P	P	P	P	P
32	17E15A0108	ANURAG RAO	P	P	P	P	P	P	P	P	P	P
33	17E15A0109	MAHESH KISHOR	P	P	P	P	P	P	P	P	P	P
34	17E15A0110	TRIVANAYATHI NAGA	P	P	P	P	P	P	P	P	P	P
35	17E15A0111	PRITHVIA SURESH	P	P	P	P	P	P	P	P	P	P
36	17E15A0112	PRITHVIA SURESH	P	P	P	P	P	P	P	P	P	P
37	17E15A0113	SANDHYA DEVI JAYASWINI	P	P	P	P	P	P	P	P	P	P
38	17E15A0114	MAHESH KISHOR	P	P	P	P	P	P	P	P	P	P

Kanish

PRINCIPAL
MAHAVEER

INSTITUTE OF SCIENCE & TECHNOLOGY
Kamathapur, Hyd-500 005.



Technical Training Exam on Auto CAD Software
(A.Y-2018-19)

2x10=20 Marks

Answer All the Questions

1. Draw the given 2D model by using AutoCad

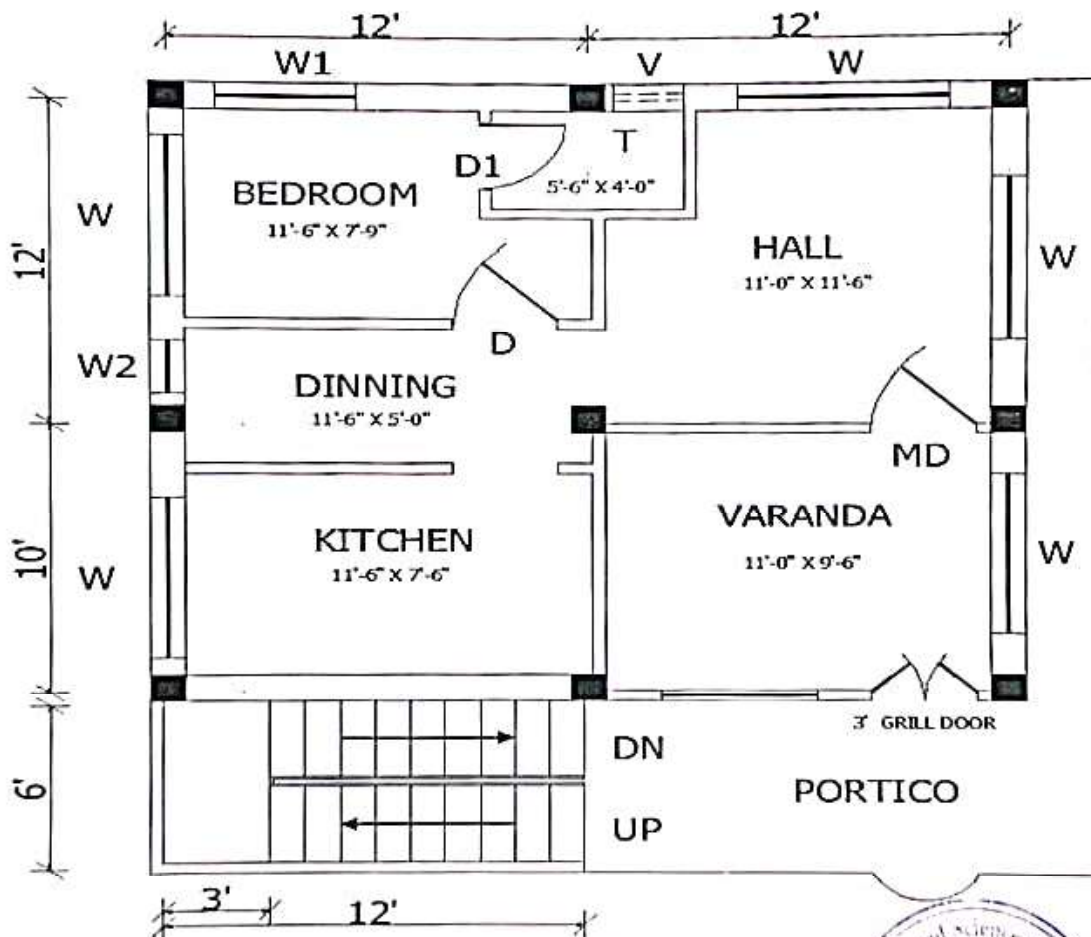

Kshubh
PRINCIPAL
MAHAVEER
INSTITUTE OF SCIENCE & TECHNOLOGY
Bandlaguda,
S.



2. (a) Draw the following using any CAD software and add dimensioning.
 (b) List the commands in sequence and also write the procedure
 (c) Add title box containing Student PIN, name and college name

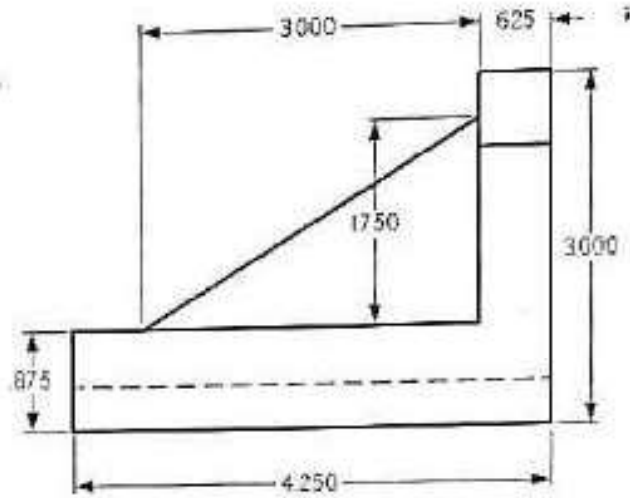
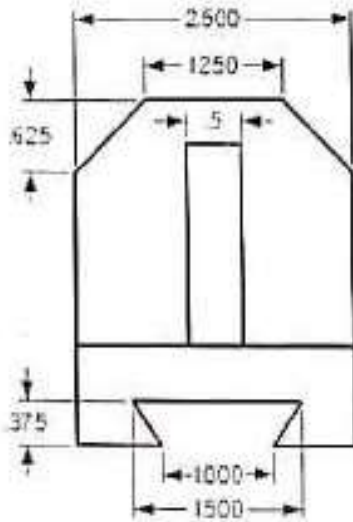

Handwritten signature

**PRINCIPAL
 MAHAVEER**

MAHARAJA INSTITUTE OF SCIENCE & TECHNOLOGY

Warananasi, Varanasi - 221005 (U.P.)

Department of Civil Engineering
Auto CAD Technical Training student attendance list 2018-19

S.No	Hall Ticket No	Name of the Candidate	Year	Marks	Pass/Fai I
1	17E31A0101	ANNALDAS JANAKI	II	16	Pass
2	17E31A0102	ARSHI FIRDAUSH	II	16	Pass
3	17E31A0103	B SOHAN LAL	II	15	Pass
4	17E31A0105	BHUKYA RAJU	II	15	Pass
5	17E31A0106	BHUKYA RAVIKUMAR	II	17	Pass
6	17E31A0107	BOLLAM VIJAY KUMAR	II	16	Pass
7	17E31A0108	CHELUMALLA VIKAS REDDY	II	16	Pass
8	17E31A0109	CHENNAKESHI MANIKANTA MUDHIRAJ	II	18	Pass
9	17E31A0110	D TEJA	II	17	Pass
10	17E31A0113	DEVALLA SMARANI	II	15	Pass
11	17E31A0114	ESSAM KAVYA	II	16	Pass
12	17E31A0116	HALAVATH HARI KRISHNA	II	15	Pass
13	17E31A0121	M A GHANIUDDIN	II	18	Pass
14	17E31A0122	MADDELA ARUN KUMAR	II	17	Pass
15	17E31A0125	MOHAMMED MUQTAR PATEL	II	16	Pass
16	17E31A0128	MOHD MAJEED UDDIN	II	17	Pass
17	17E31A0135	PAKALA SAI PRASAD	II	15	Pass
18	17E31A0138	SHARAVATH SREEDHER	II	16	Pass
19	17E31A0139	SHIVARATRI KUMAR	II	16	Pass

K. Mahaveer
PRINCIPAL
MAHAVEER
TKST COLLEGE OF ENGINEERING & TECHNOLOGY
BANDARPOLE, V.V.V. ROAD, SUDHAPUR.

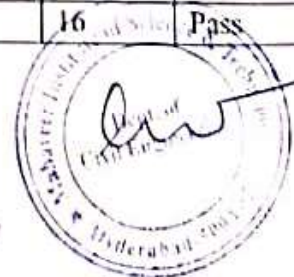

20	17E31A0140	SIDDAMSETTI AVINASHI	II	16	Pass
21	17E31A0141	SK REHMATHIBABA	II	15	Pass
22	17E31A0142	SUNKARA HARSHAVARDHAN	II	17	Pass
23	17E31A0143	TURUKA PAVANI	II	17	Pass
24	17E31A0144	YATHAM SAI YASHAWINI	II	18	Pass
25	18E35A0101	ADNAN ABDUL WASE	II	17	Pass
26	18E35A0102	BADALA VARA PRASAD	II	17	Pass
27	18E35A0103	BHOOKYA DHILIP	II	16	Pass
28	18E35A0104	DHANAVATH NAGA	II	15	Pass
29	18E35A0105	DONTHARABOINA KIRAN KUMAR	II	16	Pass
30	18E35A0106	KOLLA KRANTHI KUMAR	II	16	Pass
31	18E35A0107	MANKA TUSHAL YADAV	II	17	Pass
32	18E35A0108	MERUGU ROHITH	II	18	Pass
33	18E35A0109	MULLUKUNTLA MOUNIKA	II	18	Pass
34	18E35A0110	POCHAGARI ALOK	II	16	Pass
35	18E35A0111	P DEEPA SREE	II	19	Pass
36	18E35A0112	P RAGHAVENDAR	II	18	Pass
37	18E35A0113	SANDADI TEJASWINI	II	19	Pass
38	18E35A0114	venu GOPAL	II	17	Pass



Handwritten signature

PRINCIPAL
MAHAVEER
INSTITUTE OF SCIENCE & TECHNOLOGY
WARRANGAL

Vysapuri, Bandlaguda Post:Keshavgiri,
Hyderabad-500 005, Telangana INDIA
Tel: 040-64596979,20029773, Fax: 040-24455003
E-mail: principal.mahaveer@gmail.com,
Website: www.mist.ac.in,

MAHAVEER
INSTITUTE OF SCIENCE & TECHNOLOGY
Approved by AICTE, Affiliated to JNTUH,Hyd.



Auto CAD COURSE
Summery

Department of Civil Engineering

- Use AutoCAD for daily working process.
- Navigate throughout AutoCAD using major navigating tools.
- Understand the concept and techniques to draw.
- Create multiple designs using several of tools.
- Create layers to control the objects' visibility.
- Explain drawing using annotations.
- Plot or print the drawing by scale.

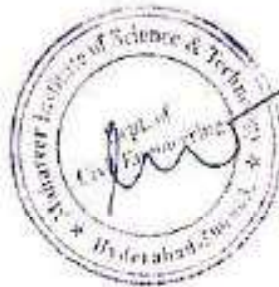

K. Mahaveer
PRINCIPAL
MAHAVEER
INSTITUTE OF SCIENCE & TECHNOLOGY
Bandlaguda, Hyd-500 005.

Vysapuri, Bandlaguda Post, Kothavalli,
Hyderabad-500 005, Telangana INDIA
Tel: 040-64596979, 20029773, Fax: 040-24455103
E-mail: principal.mahaveer@gmail.com,
Website: www.mist.ac.in,

MAHAVEER

INSTITUTE OF SCIENCE & TECHNOLOGY

Approved by AICTE, Affiliated to JNTU, Hyd.



CERTIFICATE OF COURSE COMPLETION

This certificate is presented to _____ of MIST, who
has successfully completed technical training course on "Auto
CAD" held from _____ to _____ and found the
student performance to be excellent.



ESTD : 2001

Ch. Swethamber

HOD

Civil Department

PRINCIPAL
MAHAVEER
INSTITUTE OF SCIENCE & TECHNOLOGY
Bandlaguda, Hyd 500 005



Vysapuri, Bandlaguda Post, Keshavnagar,
Hyderabad-500 005, Telangana INDIA
Tel: 040-64596979, 20020773, Fax: 040-24455003
E-mail: principal.mahaveer2@gmail.com
Website: www.mist.ac.in

MAHAVEER

INSTITUTE OF ENGINEERING & TECHNOLOGY
Approved by AICTE, Affiliated to JNTU R.H.Y.S.



DEPARTMENT OF CIVIL ENGINEERING

PROPOSAL LETTER

Hyderabad,

17/04/2018.

To,
The principal,
MIST,
Hyderabad.

Sub: Proposal for three weeks workshop on REVIT-Reg,

Dear Sir,

We are working as asst professor in the department of CIVIL ENGINEERING. Sir, we are going to conduct three weeks workshop on REVIT. We require your approval to go head for further proceeding and hope to get an opportunity to serve you the best.

With thanks and Regards

From,

Civil Department

Mist,

Bandlaguda,



(Signature)
PRINCIPAL
MAHAVEER
INSTITUTE OF ENGINEERING & TECHNOLOGY
Bandlaguda, Hyd-500 005.

Vysapuri, Bandlaguda Post:Keshavgiri,
Hyderabad-500 005, Telangana INDIA
Tel: 040-64596979,20020773, Fax: 040-24455003
E-mail: principal.mahaveer@gmail.com,
Website: www.mist.ac.in

MAHAVEER

INSTITUTE OF SCIENCE & TECHNOLOGY

Approved by AICTE, Affiliated to JNTUH,Hyd.



Date: 03.05.2018

CIRCULAR

Technical Training for U B. Tech students are starting from 3rd MAY, 2018 onwards. All HODs and Placements coordinators have to manage the trainings and ensure 95% attendance all through the sessions.

All Mentors need to send the compiled feedback report to CH.Swethamber, HOD at e3hod.civil@gmail.com daily.

Agenda: 1. Introduction to Revit.

Designed by:- B.RAMANA KUMAR

R.BHEEMLAL

CH.SWETHAMBER

HOD

PRINCIPAL
MAHAVEER
INSTITUTE OF SCIENCE & TECHNOLOGY
Bandlaguda, Post:Keshavgiri,
Hyderabad-500 005.





REVIT SYLLABUS

DAY	SUBJECT	KEYWORD
Day-1	Introduction to BIM & Autodesk Revit	1.IntroductiontoBIM&Revit 2.Version ofRevit 3.Starting Projects 4.User Interface
Day-2	SettingupLevels&wall, addingcomponents	1.Making Levels 2.wall setup 3. 3D Componets (Interior & Exterior)
Day-3	Working with basic tools	5. Basic modify tools Moving,Copying,Mirror,Trim. 6. Workingwithadditionmodifytools
Day-4	Modelling Floors,Roofs, Stairs,Railings,Ceiling	1.Making floor & roof 2.Creating & Modifying stairs 3.Creating Railing 4.Adding Ceiling
Day-5	Working with Grid & Column	1.Creating & modify the Grid 2.Adding Column
Day-6	Working with Materials	1.Setting of Materials 2.Apply Texture & Colur
Day-7	Creating Construction Documents	5.Making Sheetfile 6.Adding planes,elevations,section,3D views
Day-8	Making Walkthrough	1.Use of camera 2.Making Animation
Day-9	Introduction to Revit Structure	1.Starting Projects 2.Overview of the interfce
Day-10	Startiing stuctural project & basic modify tools	1.SettingofLevels&Grids 2.workingwithbasictools (Move,Rotate,Copy,Mirror)
Day-11	Working with views	1.Setting the view display 2.CreatingElevation§ion
Day-12	Structurl Grids & Columns	1.Adding Grids 2.Placing Columns
Day-13	Foundation	1.Modelling walls 2.Adding wall footing 3.Adding Isolated footing
Day-14	Adding Structural Slab	1.Creating & modify Slab
Day-15	Structural Reinforcement	1.Structural Reinforcement 2.Adding Rebar 3.Modify Rebar 4.Reinforcing Slabs



PRINCIPAL
MAHAVEER

Vysapuri, Bandlaguda Post:Keshavgirl,
Hyderabad-500 005, Telangana INDIA
Tel: 040-64596979,20020773, Fax: 040-24455003
E-mail: principal.mahaveer@gmail.com,
Website: www.mist.ac.in,

MAHAVEER

INSTITUTE OF SCIENCE & TECHNOLOGY

Approved by AICTE, Affiliated to JNTUH,Hyd.



**Department of Civil Engineering
Revit Technical Training student attendance list 2018-2019**

SL.NO.	ROLL NO.	NAME OF THE STUDENT	YEAR
1	17E31A0101	ANNALDAS JANAKI	II
2	17E31A0102	ARSHI FIRDAUSH	II
3	17E31A0103	B SOHAN LAL	II
4	17E31A0105	BHUKYA RAJU	II
5	17E31A0106	BHUKYA RAVIKUMAR	II
6	17E31A0107	BOLLAM VIJAY KUMAR	II
7	17E31A0108	CHELUMALLA VIKAS REDDY	II
8	17E31A0109	CHENNAKESHI MANIKANTA MUDHIRAJ	II
9	17E31A0110	D TEJA	II
10	17E31A0113	DEVALLA SMARANI	II
11	17E31A0114	ESSAM KAVYA	II
12	17E31A0116	HALAVATH HARI KRISHNA	II
13	17E31A0121	M A GHANIUDDIN	II
14	17E31A0122	MADDELA ARUN KUMAR	II
15	17E31A0125	MOHAMMED MUQATAR PATEL	II
16	17E31A0128	MOHD MAJEED UDDIN	II
17	17E31A0135	PAKALA SAI PRASAD	II
18	17E31A0138	SHARAVATH SREEDHER	II
19	17E31A0139	SHIVARATRIN KUMAR	II
20	17E31A0140	SIDDAMSETTA VINASH	II

K. S. S. S.
PRINCIPAL
MAHAVEER
INSTITUTE OF SCIENCE & TECHNOLOGY
Bandlaguda, Hyd-500 005.



21	17E31A0141	SK REHMATHBABA	
22	17E31A0142	SUNKARA HARSHAVARDHAN	
23	17E31A0143	TURUKA PAVANI	
24	17E31A0144	YATHAM SAI YASHASWINI	
25	18E35A0101	ADNAN ABDUL WASE	
26	18E35A0102	BADALA VARA PRASAD	
27	18E35A0103	BHOOKYA DHILIP	
28	18E35A0105	DONTARABOINA KIRAN KUMAR	
29	18E35A0106	KOLLA KRANTHI KUMAR	
30	18E35A0107	MANKA TUSHAL YADAV	
31	18E35A0108	MERUGU ROHITH	
32	18E35A0109	MULLUKUNTLA MOUNIKA	
33	18E35A0110	POCHAGARI ALOK	
34	18E35A0111	P DEEPA SREE	
35	18E35A0112	P RAGHAVENDAR	
36	18E35A0113	SANDADI TEJASWINI	
37	18E35A0114	UPUTHALLI VENUGOPAL	



K. S. S. S.
PRINCIPAL
MAHAVEER
INSTITUTE OF SCIENCE & TECHNOLOGY
 Bandlaguda, Hyd-500 005.

Department of Civil Engineering
Revit Technical Training student attendance list 2018-2019

Sl.NO	Roll No	Name of the student	1	2	3	4	5	6	7	8	9	10	11	12	13	14	15
1	17E31A0101	ANNAJDAS JANAKI	P	P	P	P	P	P	A	P	P	P	P	P	P	P	P
2	17E31A0102	ARSHI FIRDAUSH	P	A	P	P	P	P	P	P	P	P	P	A	P	P	P
3	17E31A0103	B SOHAN LAL	P	P	P	A	P	P	P	A	P	P	P	P	P	P	P
4	17E31A0105	BHUKYA RAJU	P	P	P	P	A	P	P	P	P	P	P	P	P	P	P
5	17E31A0106	BHUKYA FAVIKUMAR	P	P	A	P	P	P	P	P	P	P	P	P	P	P	P
6	17E31A0107	BOLLAM VIJAY KUMAR	P	P	P	P	P	P	P	P	P	P	A	P	P	P	P
7	17E31A0108	CHELUMALLA VIKAS REDDY	A	P	P	P	P	P	A	P	P	P	P	P	P	P	P
8	17E31A0109	CHENNAKESHI MANIKANTA MUDHIRAJU	P	P	P	P	P	P	P	P	P	A	P	P	P	P	P
9	17E31A0110	D TEJA	P	P	P	P	P	P	P	P	P	P	P	P	P	P	P
10	17E31A0113	DEVALLA SMARANI	P	P	P	P	P	P	P	P	P	P	P	P	P	A	P
11	17E31A0114	ESSAM KAVYA	P	P	P	P	P	P	P	P	P	P	P	P	P	P	A
12	17E31A0116	HALAVATH HARI KRISHNA	P	P	P	P	P	P	P	P	A	P	P	P	P	P	P
13	17E31A0121	M A GHANI UDDIN	P	A	P	P	P	P	P	P	P	P	P	P	P	P	P
14	17E31A0122	MADELA ARUN KUMAR	P	P	P	P	P	P	P	P	P	P	P	P	P	P	P
15	17E31A0125	MOHAMMED MUQTAR PATEL	P	P	P	P	P	P	P	P	P	P	P	P	P	P	P
16	17E31A0128	MOHD MAJEED UDDIN	P	P	P	A	P	P	P	P	P	P	P	P	P	P	P
17	17E31A0135	PAKALA SAI PRASAD	P	P	P	P	P	P	P	P	P	P	P	P	P	P	P
18	17E31A0138	SHARAVATH SREEDHER	P	P	P	P	P	P	A	P	P	P	P	P	P	P	P



Principal
MATHA VEER
 Institute of Science & Technology
 Secunderabad, Hyd-500 005.



Technical Training Exam on Revit Software
(A.Y-2018-19)

2x10=20 Marks

Answer All the Questions

1. Draw the given 2D model into 3D model by using Revit



Mahaveer
PRINCIPAL
MAHAVEER
INSTITUTE OF SCIENCE & TECHNOLOGY
Hyderabad

2. Draw the given centre to centre floor plan into 3D model by using Revit software.



Principal
PRINCIPAL
MAHAVEER
INSTITUTE OF SCIENCE & TECHNOLOGY
Barkhaguda, Hyderabad-502 004

Vysapuri, Bandlaguda Post:Keshavgiri,
Hyderabad-500 005, Telangana INDIA
Tel: 040-64596979,20020773, Fax: 040-24455003
E-mail: principal.mahaveer@gmail.com
Website: www.mist.ac.in,

MAHAVEER

INSTITUTE OF SCIENCE & TECHNOLOGY

Approved by AICTE, Affiliated to JNTUH,Hyd.



Department of Civil Engineering
Revit Technical Training student Marks list 2018-19

Sl.NO	Roll No	Name of the student	YEAR	MARKS	PASS/FAI
1	17E31A0101	ANNALDAS JANAKI	II	16	PASS
2	17E31A0102	ARSHI FIRDAUSH	II	16	PASS
3	17E31A0103	B SOHAN LAL	II	12	PASS
4	17E31A0105	BHUKYA RAJU	II	12	PASS
5	17E31A0106	BHUKYA RAVIKUMAR	II	16	PASS
6	17E31A0107	BOLLAM VIJAY KUMAR	II	16	PASS
7	17E31A0108	CHELUMALLA VIKAS REDDY	II	16	PASS
8	17E31A0109	CHENNAKESHI MANIKANTA MUDHIRAJ	II	16	PASS
9	17E31A0110	D TEJA	II	16	PASS
10	17E31A0113	DEVALLA SMARANI	II	16	PASS
11	17E31A0114	ESSAM KAVYA	II	16	PASS
12	17E31A0116	HALAVATH HARI KRISHNA	II	16	PASS
13	17E31A0121	M A GHANIUDDIN	II	16	PASS
14	17E31A0122	MADDELA ARUN KUMAR	II	16	PASS
15	17E31A0125	MOHAMMED MUQTAR PATEL	II	16	PASS
16	17E31A0128	MOHD MAJEED UDDIN	II	16	PASS
17	17E31A0135	PAKALA SAI PRASAD	II	16	PASS
18	17E31A0138	SHARAVATH SREEDHER	II	16	PASS
19	17E31A0139	SHIVARATRIN KUMAR	II	15	PASS
20	17E31A0140	SIDDAMSETTI AVINASH	II	16	PASS
21	17E31A0141	SK REHMATHBABA	II	16	PASS

PRINCIPAL
MAHAVEER

22	17E31A0142	SUNKARA HARSHAVARDHAN	II	15	PASS
23	17E31A0143	TURUKA PAVANI	II	16	PASS
24	17E31A0144	YATHAM SAI YASHASWINI	II	14	PASS
25	18E35A0101	ADNAN ABDUL WASE	II	15	PASS
26	18E35A0102	BADALA VARA PRASAD	II	15	PASS
27	18E35A0103	BHOOKYA DHILIP	II	16	PASS
28	18E35A0105	DONTHARABOINA KIRAN KUMAR	II	14	PASS
29	18E35A0106	KOLLA KRANTHI KUMAR	II	16	PASS
30	18E35A0107	MANKA TUSHAL YADAV	II	15	PASS
31	18E35A0108	MERUGU ROHITH	II	14	PASS
32	18E35A0109	MULLUKUNTLA MOUNIKA	II	18	PASS
33	18E35A0110	POCHAGARI ALOK	II	15	PASS
34	18E35A0111	P DEEPA SREE	II	16	PASS
35	18E35A0112	P RAGHAVENDAR	II	15	PASS
36	18E35A0113	SANDADI TEJASWINI	II	16	PASS
37	18E35A0114	UPUTHALLI VENUGOPAL	II	15	PASS



K. S. Srinivas
 PRINCIPAL
 MANAVEER
 UNIVERSITY
 BANGALORE

Vysapuri, Bandlaguda Post:Keshavnagar,
Hyderabad-500 005, Telangana INDIA
Tel: 040-64596979,20020773, Fax: 040-24455003
E-mail: principal.mahaveer@gmail.com
Website: www.mist.ac.in

MAHAVEER

INSTITUTE OF SCIENCE & TECHNOLOGY
Approved by AICTE, Affiliated to JNTUH,Hyd.



Revit COURSE
Summary

Department of Civil Engineering

- Use Revit for daily working process.
- Navigate throughout Revit using major navigating tools.
- Understand the concept and techniques to draw.
- Create multiple designs using several of tools.
- Create layers to control the objects' visibility.
- Explain drawing using annotations.
- Plot or print the drawing by scale.
- To use constraint for certain design.

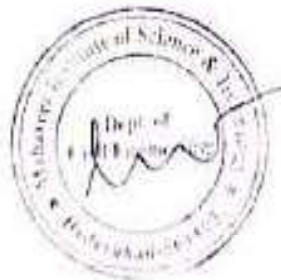

K. Srinivas
PRINCIPAL
MAHAVEER
INSTITUTE OF SCIENCE & TECHNOLOGY
Bandlaguda, Hyd-500 005

Vyasepuri, Bandlaguda Post:Keshavpuri,
Hyderabad-500 036, Telangana INDIA
Tel: 040-64596979,20020773, Fax: 040-24455033
E-mail: principal.mahaveer@gmail.com
Website: www.mist.ac.in

MAHAVEER

INSTITUTE OF SCIENCE & TECHNOLOGY

Approved by AICTE, Affiliated to JNTU/H,Hyd.



CERTIFICATE OF COURSE COMPLETION

This certificate is presented to _____ of MIST, who has successfully completed technical training course on "Revit" held from _____ to _____ and found the student performance to be excellent.



ESTD : 2001

CH.SWETHAMBER

HOD

Civil Department



PRINCIPAL
MAHAVEER
INSTITUTE OF SCIENCE & TECHNOLOGY
BANDLAGUDA

Vysapuri, Bandlaguda Post:Keshavgiri,
Hyderabad-500 005, Telangana INDIA
Tel: 040-64596979,20020773,, Fax: 040-24455003
E-mail: principal.mahaveer@gmail.com,
Website: www.mist.ac.in,

MAHAVEER

INSTITUTE OF SCIENCE & TECHNOLOGY

Approved by AICTE, Affiliated to JNTUH,Hyd.



PROPOSAL LETTER

Hyderabad,

3/08/2018.

To,
The principal,
MIST,
Hyderabad.

Sub: Proposal for three weeks workshop on GEO5-Reg,

Dear Sir,

We are working as asst professor in the department of CIVIL ENGINEERING. Sir, we are going to conduct three weeks workshop on GEO5. We require your approval to go head for further proceeding and hope to get an opportunity to serve you the best.

With thanks and Regards

From,
Civil Department
Mist,
Bandlaguda,
Hyderabad.



PRINCIPAL
MAHAVEER
INSTITUTE OF SCIENCE & TECHNOLOGY
Bandlaguda, Hyd-500 005.

Vysapuri, Bandlaguda Post:Keshavgiri,
Hyderabad-500 005, Telangana INDIA
Tel: 040-64596979,20020773,,Fax: 040-24455003
E-mail: principal.mahaveer@gmail.com,
Website: www.mist.ac.in,

MAHAVEER
INSTITUTE OF SCIENCE & TECHNOLOGY
Approved by AICTE, Affiliated to JNTUH,Hyd.



Date: 10.08.2018

CIRCULAR

Technical Training for II B. Tech students are starting from 16th AUGUST, 2018 onwards. All HODs and Placements coordinators have to manage the trainings and ensure 95% attendance all through the sessions.

All Mentors need to send the compiled feedback report to CH.SWETHAMBER, HOD at e3hod.civil@gmail.com daily.

Agenda: 1. Introduction to GEOS SOFTWARE

CH.SWETHAMBER
HOD

Design by: B.RAMANA KUMAR
K.SAI PRADEEP

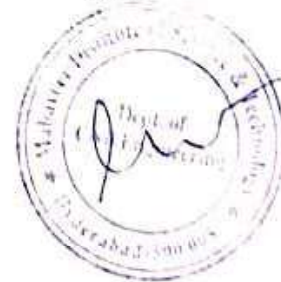

Principal
PRINCIPAL
MAHAVEER
INSTITUTE OF SCIENCE & TECHNOLOGY
Bandlaguda, Hyd-500 005.

Vysapuri, Bandlaguda Post:Keshavgi,
Hyderabad-500 005, Telangana INDIA
Tel: 040-64596979,20020773, Fax: 040-24455003
E-mail: principal.mahaveer@gmail.com,
Website: www.mist.ac.in,

MAHAVEER
INSTITUTE OF SCIENCE & TECHNOLOGY
Approved by AICTE, Affiliated to JNTUH,Hyd.



GEO5 SYLLABUS

Getting started with GEO5 SOFTWARE

- 1) Design of a cantilever wall
- 2) Verification of a gravity wall
- 3) Design of a non-anchored retaining wall
- 4) Design of an anchored retaining wall
- 5) Verification of a multi anchored wall
- 6) Slope stability analysis
- 7) Design of the geometry of a spread footing
- 8) Settlement of a spread footing
- 9) Analysis of a consolidation under embankment
- 10) Pile foundations-introduction



Kishu
PRINCIPAL
MAHAVEER
INSTITUTE OF SCIENCE & TECHNOLOGY
Bandlaguda, Hyd-500 005.

Vysapuri, Bandlaguda Post:Keshavgi,
Hyderabad-500 005, Telangana INDIA
Tel: 040-64596979, 20020773, Fax: 040-24455003
E-mail: principal.mahaveer@gmail.com,
Website: www.misl.ac.in,

MAHAVEER

INSTITUTE OF SCIENCE & TECHNOLOGY

Approved by AICTE, Affiliated to JNTUH,Hyd.



MAHAVEER INSTITUTE OF SCIENCE & TECHNOLOGY, HYDERABAD			
B.TECH IV YEAR I SEM			
CIVIL ENGINEERING 2018-19 BATCH			
S.No	Hall Ticket No	Name of the Candidate	YEAR
1	15E31A0101	A DIVISHA	IV
2	15E31A0103	BAGUROTHU SAIUJWALA	IV
3	15E31A0108	CHANDA VENKATESH	IV
4	15E31A0109	DHADI VIJAY	IV
5	15E31A0111	ELISHETTY TEJASWINI	IV
6	15E31A0112	ERUKULLA SRIKANTH	IV
7	15E31A0115	GOPI PRANAY	IV
8	15E31A0117	LOKASANI SURENDER REDDY	IV
9	15E31A0118	M AVINASHI	IV
10	15E31A0119	MADIRE NARESH	IV
11	15E31A0120	MD ABDUL MUNAM	IV
12	15E31A0121	MD SALMAN CHOUDHARY	IV
13	15E31A0122	MOHAMMED ETHESHAM	IV
14	15E31A0123	MOHD AHMED	IV
15	15E31A0124	MUBARAK ALI DAYANI	IV
16	15E31A0125	NENAVATH SANTHOSH	IV
17	15E31A0130	PHTATA RAJESH KUMAR	IV



isubh
PRINCIPAL
MAHAVEER
INSTITUTE OF SCIENCE & TECHNOLOGY
Bandlaguda, Hyd-500 005.

18	15E31A0131	SABIR ALIE	IV
19	15E31A0133	SHEELAM PRAMOD KUMAR	IV
20	15E31A0134	SIDDINI CHIANDU	IV
21	15E31A0140	VADLA SHRAVAN KUMAR	IV
22	15E31A0142	ZEESHAN ASHRAF	IV
23	15E31A0143	M A KHADER ANSARI	IV
24	15E31A0144	PALAJU SRICHATHANYA	IV
25	15E31A0145	GOLLA VISHNU YADAV	IV
26	16E35A0101	GADDAM CHARAN	IV
27	16E35A0102	GUNDALA MANISH	IV
28	16E35A0103	JANAPATI RAVI	IV
29	16E35A0104	M PRASHANTH	IV
30	16E35A0105	M. RANJITHA	IV
31	16E35A0107	P.PRAVALIKA	IV
32	16E35A0108	POGAKU KEERTHI MADHURI	IV
33	16E35A0109	REDAPAKA MAHESHWARI	IV
34	14E31A0102	ABDUR RAHEEM MUNNAWWAR	IV
35	14E31A0133	MOHD ABDUL ALL FUZAIL	IV
36	13E31A0108	VINAY	IV

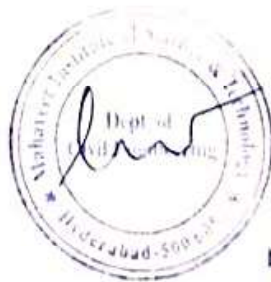

K. S. S. S.

PRINCIPAL
MAHAVEER
 INSTITUTE OF SCIENCE & TECHNOLOGY
 Bandlaguda, Hyd-500 005.

MAHAAVEER INSTITUTE OF SCIENCE & TECHNOLOGY, HYDERABAD
CIVIL ENGINEERING STUDENTS ATTENDANCE

B.TECH IV YEAR I SEM 2018-2019 BATCH (Date : 16-08-2018 to 27-08-2018)

S.No	Hall Ticket No	Name of the Candidate	1	2	3	4	5	6	7	8	9	10
1	15E31A0101	A DIVISHA	P	A	P	P	P	A	P	P	P	P
2	15E31A0103	BAGUROTHU SAJJUWALA	A	A	P	P	P	P	P	P	P	P
3	15E31A0108	CHANDA VENKATESH	P	P	P	P	A	P	P	A	P	P
4	15E31A0109	DEHADI VIJAY	P	P	P	P	P	P	A	A	P	P
5	15E31A0111	ELISHETTY TEJASWINI	P	P	P	P	A	P	P	P	P	P
6	15E31A0112	ERUKULLA SRIKANTH	P	P	A	P	P	P	P	P	P	P
7	15E31A0115	GOPI PRANAY	P	P	P	P	P	P	P	P	P	P
8	15E31A0117	LOKASANI SURENDER REDDY	A	P	P	P	P	P	P	P	P	P
9	15E31A0118	M AVINASH	P	P	P	P	P	P	P	P	P	P
10	15E31A0119	MADIRE NARESH	A	A	P	P	P	P	P	P	P	P
11	15E31A0120	MD ABDUL MUNAM	P	P	P	A	P	P	P	A	P	P
12	15E31A0121	MD SALMAN CHOUDHARY	P	P	P	P	P	P	P	P	A	P
13	15E31A0122	MOHAMMED ETIESHAM	P	P	P	P	A	P	P	P	P	P
14	15E31A0123	MOFID AHMED	P	P	P	P	P	A	P	P	P	P
15	15E31A0124	MUBARAK ALI DAYANI	P	P	P	P	P	A	P	P	P	P
16	15E31A0125	NENAVATHI SANJHOSHI	P	P	P	P	P	P	P	P	P	P
17	15E31A0130	PITTALA RAJESH KUMAR	P	P	A	P	P	P	P	P	P	P
18	15E31A0131	SABIR ALJE	P	A	P	P	P	P	P	P	P	A
19	15E31A0133	SHEELAM PRAMOD KUMAR	P	P	P	P	P	A	P	P	P	P
20	15E31A0134	SIDDINI CHANDU	P	P	P	P	P	P	P	A	A	P
21	15E31A0140	VADLA SHRAVAN KUMAR	P	A	A	P	P	P	P	P	P	P
22	15E31A0142	ZEESHAN ASHRAF	P	P	P	P	P	P	A	P	P	P
23	15E31A0143	M.A KHADER ANSARI	P	A	P	P	P	P	P	P	P	P
24	15E31A0144	PALOJU SRICHATHANYA	P	P	P	P	P	P	P	P	P	P
25	15E31A0145	GOLLA VISHNU YADAV	P	P	P	A	P	P	P	P	P	P



Principal
MAHAAVEER
 MAHAAVEER INSTITUTE OF SCIENCE & TECHNOLOGY
 HYDERABAD

Vysapuri, Bandlaguda Post:Keshavgiri,
Hyderabad-500 095, Telangana INDIA
Tel: 040-64556979,20020773, Fax: 040-24455003
E-mail: principal.mahaveer@gmail.com,
Website: www.mist.ac.in,

MAHAVEER
INSTITUTE OF SCIENCE & TECHNOLOGY
Approved by AICTE, Affiliated to JNTUH,Hyd.



Technical Training Exam on GEO5 Software
(A.Y-2018-19)

2x10=20 Marks

Answer All the Questions

- 1) What is plaxis 2D?
- 2) What is geotechnical analysis system?

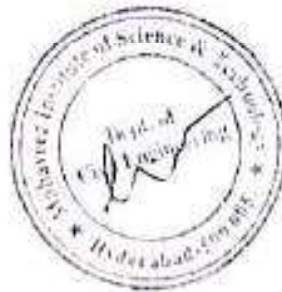

K. Srinivas
PRINCIPAL
MAHAVEER
INSTITUTE OF SCIENCE & TECHNOLOGY
Bandlaguda, Hyderabad, Telangana

Vysapuri, Bandlaguda Post:Keshavgiri,
Hyderabad-500 005, Telangana INDIA
Tel: 040-64596979,20020773, Fax: 040-24455003
E-mail: principal.mahaveer@gmail.com,
Website: www.mist.ac.in,

MAHAVEER

INSTITUTE OF SCIENCE & TECHNOLOGY

Approved by AICTE, Affiliated to JNTUH,Hyd.



MAHAVEER INSTITUTE OF SCIENCE & TECHNOLOGY, HYDERABAD					
B.TECH IV YEAR I SEM					
CIVIL ENGINEERING 2018-19 BATCH					
S.No	Hall Ticket No	Name of the Candidate	Year	Marks	Pass/Fail
1	15E31A0101	A DIVISHA	IV	16	Pass
2	15E31A0103	BAGURCTHU SAIUJWALA	IV	15	Pass
3	15E31A0108	CHANDA VENKATESH	IV	14	Pass
4	15E31A0109	DHADI VIJAY	IV	15	Pass
5	15E31A0111	ELISHETTY TEJASWINI	IV	12	Pass
6	15E31A0112	ERUKULLA SRIKANTH	IV	13	Pass
7	15E31A0115	GOPI PRANAY	IV	14	Pass
8	15E31A0117	LOKASANI SURENDER REDDY	IV	16	Pass
9	15E31A0118	M AVINASH	IV	15	Pass
10	15E31A0119	MADIRE NARESH	IV	14	Pass
11	15E31A0120	MD ABDUL MUNAM	IV	13	Pass
12	15E31A0121	MD SALMAN CHOUDHARY	IV	14	Pass
13	15E31A0122	MOHAMMED ETHESHAM	IV	12	Pass
14	15E31A0123	MOHD AHMED	IV	15	Pass
15	15E31A0124	MUBARAK ALI DAYANI	IV	14	Pass
16	15E31A0125	NENAVATH SANTHOSH	IV	15	Pass
17	15E31A0130	PITTALA RAJESH KUMAR	IV	14	Pass



(Signature)
PRINCIPAL
MAHAVEER
INSTITUTE OF SCIENCE & TECHNOLOGY
Bandlaguda, Hyd-500 005

18	15E31A0131	SABIR ALIE	IV	12	Pass
19	15E31A0133	SHEELAM PRAMOD KUMAR	IV	15	Pass
20	15E31A0134	SIDDINI CHANDU	IV	16	Pass
21	15E31A0140	VADLA SHRAVAN KUMAR	IV	15	Pass
22	15E31A0142	ZEESHAN ASHRAF	IV	14	Pass
23	15E31A0143	M A KHADER ANSARI	IV	15	Pass
24	15E31A0144	PALOJU SRICHAITHANYA	IV	16	Pass
25	15E31A0145	GOLLA VISHNU YADAV	IV	15	Pass
26	16E35A0101	GADDAM CHARAN	IV	14	Pass
27	16E35A0102	GUNDALA MANISHI	IV	15	Pass
28	16E35A0103	JANAPATI RAVI	IV	12	Pass
29	16E35A0104	M PRASHANTH	IV	13	Pass
30	16E35A0105	M. RANJITHA	IV	14	Pass
31	16E35A0107	P.PRAVALIKA	IV	12	Pass
32	16E35A0108	POGAKU KEERTHI MADHURI	IV	16	Pass
33	16E35A0109	REDAPAKA MAHESHWARI	IV	15	Pass
34	14E31A0102	ABDUR RAHEEM MUNNAWWAR	IV	13	Pass
35	14E31A0133	MOHD ABDUL ALL FUZAIL	IV	12	Pass
36	13E31A0108	VINAY	IV	13	Pass



Mahaveer
PRINCIPAL
MAHAVEER
 INSTITUTE OF SCIENCE & TECHNOLOGY
 Bandlaguda, Hyd-500 005.

Vysapuri, Bandlaguda Post:Keshavgiri,
Hyderabad-500 005, Telangana INDIA
Tel: 040-64596579,20020773, Fax: 040-24455003
E-mail: principal.mahaveer@gmail.com,
Website: www.mist.ac.in,

MAHAVEER

INSTITUTE OF SCIENCE & TECHNOLOGY

Approved by AICTE, Affiliated to JNTUH,Hyd.



GEO5 COURSE

Summery

Department of Civil Engineering

- Use GEO5 for daily working process.
- Navigate throughout GEO5 using major navigating tools.
- Understand the concept and techniques to draw.
- Create multiple designs using several of tools.
- Create layers to control the objects' visibility.
- Explain drawing using annotations.
- Plot or print the drawing by scale.
- To use constraint for certain design.



Principal
PRINCIPAL
MAHAVEER
INSTITUTE OF SCIENCE & TECHNOLOGY
Bandlaguda, Hyd-500 005.

Vysapuri, Bandlaguda Post:Keshavgiri,
Hyderabad-500 005, Telangana INDIA
Tel: 040-64596979,20020773,,Fax: 040-24455003
E-mail: principal.mahaveer@gmail.com,
Website: www.mist.ac.in,

MAHAVEER

INSTITUTE OF SCIENCE & TECHNOLOGY
Approved by AICTE, Affiliated to JNTUH,Hyd.



CERTIFICATE OF COURSE COMPLETION

This certificate is presented to _____ of MIST, who
has successfully completed technical training course on "GEO5"
held from _____ to _____ and found the student
performance to be excellent.



ESTD : 2001

CH.SWETHAMBER
HOD
Civil Department

K. Srinivas

PRINCIPAL
MAHAVEER
INSTITUTE OF SCIENCE & TECHNOLOGY
Bandlaguda, Hyd-500 005.



Vysapuri, Bandlaguda Post:Keshavgi,
Hyderabad-500 005, Telangana INDIA
Tel: 040-64596979,20020773, Fax: 040-24455003
E-mail: principal.mahaveer@gmail.com,
Website: www.mist.ac.in,

MAHAVEER
INSTITUTE OF SCIENCE & TECHNOLOGY
Approved by AICTE, Affiliated to JNTUH,Hyd.



PROPOSAL LETTER

Hyderabad,

12/03/2018.

To
The principal,
MIST,
Hyderabad.

Sub: Proposal for three weeks workshop on STADD PROVIS-Reg,

Dear Sir,

We are working as asst professor in the department of CIVIL ENGINEERING. Sir, we are going to conduct three weeks workshop on STADD PROVIS. We require your approval to go head for further proceeding and hope to get an opportunity to serve you the best .

With thanks and Regards



K. Srinivas
PRINCIPAL
MAHAVEER
INSTITUTE OF SCIENCE & TECHNOLOGY
Bandlaguda, Hyd-500 005.

From,
Civil Department,
Mist,
Bandlaguda,
Hyderabad.



Date: 14.03.2018

CIRCULAR

Technical Training for II B. Tech students are starting from 14th March, 2018 onwards.
All HODs and Placements coordinators have to manage the trainings and ensure 95% attendance all through the sessions.

All Mentors need to send the compiled feedback report to , HOD at e3hod.civil@gmail.com daily.

Agenda: 1. Introduction to STAAD.ProVi8

DESIGNED BY

B. VARALAXMI
N SARITHA

CH SWETHAMBER

HOD



Handwritten signature
PRINCIPAL
MAHAVEER
INSTITUTE OF SCIENCE & TECHNOLOGY
HYDERABAD-500 005.



STAAD.ProVi8 SYLLABUS

Chapter 1: Before you start using Bentley STAAD.ProVi8

- o. Understanding Unit Conversion Tables
- p. Overview of Structural Design & Analysis
- q. Stresses and Stains
- r. Shear Force & Bending Moment Diagrams
- s. Introduction to Types of Structures
- t. Overview of Steel, Concrete and Foundation Design
- u. Introduction to Finite Element Analysis

Chapter 2: Introduction to STAAD.Pro

- w. About Bentley STAAD.Pro
- x. Starting STAAD.Pro
- y. Graphical User Interface
- z. Starting a New Project
- aa. Working with User Interface:
 - Menu Bars
 - Tool Bars
 - Tabs
 - Snap Node / Beam Window
 - Data Area
 - Main Window
- bb. Opening and Existing Project
- cc. Saving a Project
- dd. Configuring Units
- ee. Keyboard Shortcuts
- ff. Importing Model in STAAD.Pro
- gg. Coordinate Systems

Chapter 3: Structural Modeling

- w. Adding Beams using Tools
- x. Creating Beams (Colinear, Along Axes)
- y. Creating Plates
- z. Creating Surfaces
- aa. Creating Solid Elements
- bb. Creating Structure
- cc. Stretching and Intersecting Members
- dd. Merging Members and Nodes
- ee. Renumbering Nodes, Members and Elements
- ff. Splitting and Breaking Beams
- gg. Cutting Sections

Mahaveer
PRINCIPAL
MAHAVEER
INSTITUTE OF SCIENCE & TECHNOLOGY
HYDRABAD-500 005.



Chapter 4: Material Constants and Section Properties

k. Material Constants

Creating and Editing Material Properties

- l. Assigning Materials to the Structure
- m. Orthotropic Materials
- n. Section Properties
 - Prismatic Sections
 - Tapered Sections
 - Steel Sections
 - Steel Joist and Joist Girders
 - Plate/Surface Thickness

Chapter 5: Member Specifications and Supports

- i. Node Specification
- j. Member Specifications
 - Release
 - Offset
 - Property Reduction factors
 - Cable
 - Truss
 - Compression
 - Tension
 - Inactive
- k. Plate Specifications
 - Release
 - Ignore Inplane Rotation
 - Plane Stress
- l. Supports:
 - Fixed
 - Pinned
 - Fixed But
 - Enforced
 - Enforced But
 - Multilinear Spring
 - Foundation
 - Inclined
 - Tension/Compression Only Springs

Chapter 6: Loads

- g. Types of Loads: Selfweight, Nodal, Member, Area, Floor, Plate, Surface and Solid,
- h. Load Generation
- i. Load Combinations

Chapter 7: Performing Analysis

- e. PreAnalysis
 - Problem Statistics
 - Joint Coordinates
 - Member Information
 - Material Properties
 - Support Information
 - Element & Solid Information
- f. Performing Analysis

Handwritten signature

PRINCIPAL
MAHAVEER

10/11/2020

10/11/2020

10/11/2020



Chapter 8: Post Processing & Report Creation

- i. Post AnalysisPrint
 - LoadLists
 - JointDisplacement
 - MemberForces

 - SupportReactions
 - CG
 - ModeShapes
 - SectionDisplacement
 - Analysis Results
 - MemberStresses
 - ElementForces/Stresses
- j. ViewingResults
- k. OutputFile
- l. Post ProcessingMode

Chapter 9: Analysis Case Studies / Workshops

- i. RCCDesign&Analysis(BeamsandColumns)
- j. SteelDesign&Analysis(FramesandTrusses)
- k. MiscellaneousAnalysis
- l. Practice examples forStudents

Manish
PRINCIPAL
MAHAVEER
INSTITUTE OF SCIENCE & TECHNOLOGY
Bardoliya, Dist. Panchmahal 389 105



Vysapuri, Bandlaguda Post:Keshavgiri,
Hyderabad-500 005, Telangana INDIA
Tel: 040-64596979,20020773, Fax: 040-24455003
E-mail: principal.mahaveer@gmail.com,
Website: www.mist.ac.in,

MAHAVEER
INSTITUTE OF SCIENCE & TECHNOLOGY
Approved by AICTE. Affiliated to JNTUH.Hyd.



Department of Civil Engineering
STAAD.ProVis Technical Training student attendance list 2018-19

SL.NO.	ROLL NO.	NAME OF THE STUDENT	YEAR
1	15E31A0101	A DIVISHA	IV
2	15E31A0103	BAGUROTHU SAIUJWALA	IV
3	15E31A0108	CHANDA VENKATESH	IV
4	15E31A0109	DHADI VIJAY	IV
5	15E31A0111	ELISHETTY TEJASWINI	IV
6	15E31A0112	ERUKULLA SRIKANTH	IV
7	15E31A0115	GOPI PRANAY	IV
8	15E31A0117	LOKASANI SURENDER REDDY	IV
9	15E31A0118	M AVINASH	IV
10	15E31A0120	MD ABDUL MUNAM	IV
11	15E31A0121	MD SALMAN CHOUDHARY	IV
12	15E31A0122	MOHAMMED ETHESHAM	IV
13	15E31A0123	MOHD AHMED	IV
14	15E31A0124	MUBARAK AL DAYANI	IV
15	15E31A0125	NENAVATH SANTHOSH	IV
16	15E31A0130	PITTALA RAJESH KUMAR	IV
17	15E31A0131	SABIR ALIE	IV
18	15E31A0133	SHEELAM PRAMOD KUMAR	IV
19	15E31A0134	SIDDINI CHANDU	IV
20	15E31A0140	VADLA SHRAVAN KUMAR	IV
21	15E31A0142	ZEESHAN ASHRAF	IV
22	15E31A0143	M A KHADER ANSARI	IV
23	15E31A0144	PALOJU SRICHAITHANYA	IV
24	15E31A0145	GOLLA VISHNU YADAV	IV
25	16E35A0101	GADDAM CHARAN	IV
26	16E35A0102	GUNDALA MANISH	IV
27	16E35A0103	JANAPATI RAVI	IV
28	16E35A0104	M PRASHANTH	IV
29	16E35A0105	M. RANJITHA	IV
30	16E35A0107	P. PRAVALIKA	IV
31	16E35A0108	POGAKU KEERTHI MADHURI	IV
32	16E35A0109	REDAPAKA MAHESHWARI	IV
33	14E31A0102	Abdur Raheem Munawwar	IV
34	14E31A0133	MOHAMMED ABDUL ALI FUZAIL	IV
35	13E31A0108	B VINAY	IV

K. Srinivas
PRINCIPAL
MAHAVEER
INSTITUTE OF SCIENCE & TECHNOLOGY
HYDERABAD-500 005



MAHAVEER INSTITUTE OF SCIENCE & TECHNOLOGY, HYDERABAD

CIVIL ENGINEERING STUDENTS ATTENDANCE

B.TECH IV YEAR II SEM 2018-2019 BATCH (Date - 19/03/2018 - 24/03/2018)

S.No	Hall Ticket No	Name of the Candidate	1	2	3	4	5	6	7	8	9	10
1	15E31A0101	A DIVISHA	P	P	A	P	P	P	A	P	P	P
2	15E31A0103	SAIJWALA CHANDA	P	A	P	A	P	P	P	P	P	P
3	15E31A0108	VENKATESH	A	P	P	A	P	P	P	P	P	P
4	15E31A0109	DHADI VIDAY	P	P	P	A	P	P	P	A	P	P
5	15E31A0111	ELISHETTY TEJASWINI	A	P	P	P	P	A	P	P	P	P
6	15E31A0112	ERUKULLA SRIKANTH	P	A	P	P	A	P	P	P	P	P
7	15E31A0115	GOPI PRANAY	A	P	A	P	P	P	P	P	P	P
8	15E31A0117	LOKASANI SURENDER REDDY	A	P	P	P	P	A	P	P	P	P
9	15E31A0118	M AVINASH	P	A	A	P	P	P	P	P	P	P
10	15E31A0119	MADIRE NARESH	P	P	P	P	P	A	P	P	A	P
11	15E31A0120	MD ABDUL MUNAM	A	P	P	A	P	P	P	P	P	P
12	15E31A0121	MD SALMAN CHOLDHARY	P	P	A	P	A	P	P	P	P	P
13	15E31A0122	MOHAMMED ETHESHAM	P	P	A	P	P	P	A	P	P	P
14	15E31A0123	MOHD AHMED	P	P	P	A	P	P	P	P	A	P
15	15E31A0124	MUBARAK ALI DAYANI	P	P	P	P	P	A	P	P	P	A
16	15E31A0125	NENAVATH SANTHOSH	P	A	P	A	P	P	P	P	P	P
17	15E31A0130	PITTALA RAJESH KUMAR	P	P	P	P	P	A	A	P	P	P
18	15E31A0131	SABIR ALIE	P	P	P	P	P	P	P	P	A	P



(Signature)

PRINCIPAL
MAHAVEER
INSTITUTE OF SCIENCE & TECHNOLOGY
Bandlaguda, Hyd-500 005.



Technical Training Exam on STAAD ProVi8 Software
(A.Y-2018-19)

2x10=20 Marks

Answer All the Questions

- b. Analyse the given beam using Staad Pro Cross section of Beam 200mmx400mm Grade of Concrete M 25 Grade of Steel Fe 415. Plot SFD,BMD and deflected profile.

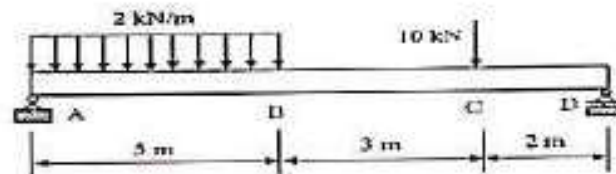

- b. Analyse the given beam using Staad Pro Cross section of Beam 200mmx400mm Grade of Concrete M 30 Grade of Steel Fe 415. Plot SFD,BMD and deflected profile.

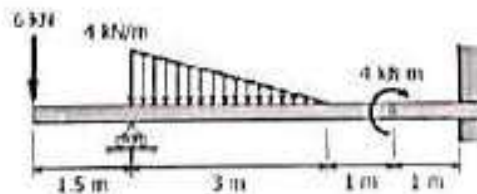

Kishu
PRINCIPAL
MAHAVEER
INSTITUTE OF SCIENCE & TECHNOLOGY
HYDARABAD-500 005.



- d. Analyse the given beam using Staad Pro Cross section of Beam 200mmx400mm Grade of Concrete M 25 Grade of Steel Fe 415. Plot SFD,BMD and deflected profile.

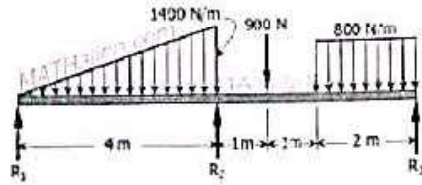

Kanish
PRINCIPAL
MAHAVEER
INSTITUTE OF SCIENCE & TECHNOLOGY
Bardhanada, Hyd-500 005.



Vysapuri, Bandlaguda Post, Keshavnigri,
Hyderabad-500 005, Telangana INDIA
Tel: 040-64596979, 20020773, Fax: 040-24455003
E-mail: principal.mahaveer@gmail.com,
Website: www.mist.ac.in,

MAHAVEER
INSTITUTE OF SCIENCE & TECHNOLOGY
Approved by AICTE, Affiliated to JNTUH, Hyd.



Department of Civil Engineering
STAAD.ProVi8 Technical Training student attendance list 2018-19

SNO	Roll No	Name of the student	YEAR	MARKS	PASS/FAIL
1	15E31A0101	A DIVISHA	IV	16	PASS
2	15E31A0103	BAGUROTHU SAIJWALA	IV	16	PASS
3	15E31A0108	CHANDA VENKATESH	IV	12	PASS
4	15E31A0109	DHADI VIJAY	IV	12	PASS
5	15E31A0111	ELISHETTY TEJASWINI	IV	16	PASS
6	15E31A0112	ERUKULLA SRIKANTH	IV	16	PASS
7	15E31A0115	GOPI PRANAY	IV	16	PASS
8	15E31A0117	LOKASANI SURENDER REDDY	IV	16	PASS
9	15E31A0118	M AVINASH	IV	16	PASS
10	15E31A0120	MD ABDUL MUNAM	IV	16	PASS
11	15E31A0121	MD SALMAN CHOUDHARY	IV	16	PASS
12	15E31A0122	MOHAMMED ETHESHAM	IV	16	PASS
13	15E31A0123	MOHD AHMED	IV	16	PASS
14	15E31A0124	MUBARAK AL DAYANI	IV	16	PASS
15	15E31A0125	NENAVATH SANTHOSH	IV	16	PASS
16	15E31A0130	PITTALA RAJESH KUMAR	IV	16	PASS
17	15E31A0131	SABIR ALIE	IV	16	PASS
18	15E31A0133	SHEELAM PRAMOD KUMAR	IV	16	PASS
19	15E31A0134	SIDDINI CHANDU	IV	15	PASS
20	15E31A0140	VADLA SHRAVAN KUMAR	IV	16	PASS
21	15E31A0142	ZEESHAN ASHRAF	IV	16	PASS
22	15E31A0143	M A KHADER ANSARI	IV	15	PASS
23	15E31A0144	PALOJU SRICHAITHANYA	IV	16	PASS
24	15E31A0145	GOLLA VISHNU YADAV	IV	14	PASS
25	16E35A0101	GADDAM CHARAN	IV	15	PASS
26	16E35A0102	GUNDALA MANISH	IV	15	PASS
27	16E35A0103	JANAPATI RAVI	IV	16	PASS
28	16E35A0104	M PRASHANTH	IV	14	PASS
29	16E35A0105	M. RANJITHA	IV	16	PASS
30	16E35A0107	P.PRAVALIKA	IV	15	PASS

K. Venkatesh
PRINCIPAL
MAHAVEER
INSTITUTE OF SCIENCE & TECHNOLOGY
Bandlaguda, Hyd-500 005.



31	16E35A0108	POGAKU KEERTHI MADHURI	IV	14	PASS
32	16E35A0109	REDAPAKA MAHESHWARI	IV	18	PASS
33	14E31A0102	Abdur Raheem Munawwar	IV	15	PASS
34	14E31A0133	MOHAMMED ABDUL ALI FUZAIL	IV	16	PASS
35	13E31A0108	B VINAY	IV	15	PASS

K. S. S. S.

PRINCIPAL
MAHAVEER
INSTITUTE OF
SCIENCE & TECHNOLOGY
Rangireddy, Hyderabad - 500 005.



Vysapuri, Bandlaguda Post:Keshavgi,
Hyderabad-500 005, Telangana INDIA
Tel: 040-64596979,20020773, Fax: 040-24455003
E-mail: principal.mahaveer@gmail.com,
Website: www.mist.ac.in,

MAHAVEER
INSTITUTE OF SCIENCE & TECHNOLOGY
Approved by AICTE, Affiliated to JNTUH,Hyd.



STAAD PRO COURSE
Summery

Department of Civil Engineering

- Model Generation and Editing
- Assigning loads
- Creating Load Combinations
- Concrete Design
- Seismology
- Steel Design
- Foundation Designs
- Report Generation and Plotting

PRINCIPAL
MAHAVEER
INSTITUTE OF SCIENCE & TECHNOLOGY
Bandlaguda, Hyd-500 005.



Vysapuri, Bandlaguda Post Keshavgi,
Hyderabad-500 005, Telangana INDIA
Tel: 040-64596979, 20020773, Fax: 040-24455003
E-mail: principal.mahaveer@gmail.com,
Website: www.mist.ac.in,

MAHAVEER

INSTITUTE OF SCIENCE & TECHNOLOGY

Approved by AICTE, Affiliated to JNTUH, Hyd.



CERTIFICATE OF COURSE COMPLETION

This certificate is presented to _____ of
MIST, who has successfully completed technical training course
on “STAAD PROVi8” held from _____ to _____
and found the student performance to be excellent.



ESTD : 2001

CH. SWETHAMBER

HOD

Civil department



K. S. S.
PRINCIPAL
MAHAVEER
INSTITUTE OF SCIENCE & TECHNOLOGY
BANDLAGUDA POST, HYDERABAD.

Vysapuri, Bandlaguda Post: Keshavgiri,

MAHAVEER



Hyderabad-500 005, TELANGANA INDIA

Tel: 040-64596979,8978380692 Fax: 040-24455003

E-mail: e3hod.eee@gmail.com,

Website: www.mist.ac.in,

Approved by AICTE, Affiliated to JNTUH.Hyd

DEPARTMENT OF ELECTRICAL & ELECTRONICS

Date: 1-09-2018

To
The Principal,
Mist,
Hyderabad.

Sub:Proposal for Add on course-Reg.

Respected sir,

We are going to conduct two weeks workshop on **PLC Programming**. We require your approval to go head for further proceeding and hope to get an opportunity to serve you the best.

With thanks and regards

R.V.Amarith

HOD-EEE

Principal
PRINCIPAL
MAHAVEER
INSTITUTE OF SCIENCE & TECHNOLOGY
Bandlaguda, Hyd-500 005.

Professor & Head
Dept. of Electrical & Electronics
Mahaveer Institute of Science & Tech
Vysapuri, Bandlaguda, Keshavgiri,
Hyderabad - 500 005.



DEPARTMENT OF ELECTRICAL & ELECTRONICS

Date: 01-09-2018

CIRCULAR

Technical Trainings for III B Tech students are starting from 11-09-2018 onwards. All HODs and placements coordinators have to manage the trainings and ensure 95% attendance all through the sessions.

All mentors need to send the compiled feedback report to HOD at e3hod.eee@gmail.com daily. Mentors are advised to take care of PNR (Students not participating in training).

Agenda: Plc Programming

Design & Development of Curriculum for Add on Courses Faculty Names: 1. Dr. Rv. Amarnath
2. PVV SATYA NARAYANA

pr

M.A. B. S. N.
INSTITUTE OF SCIENCE & TECHNOLOGY
Bandlaguda, Hyd-500 005.

Professor & Head
Dept. of Electrical & Electronics Engg
Mahaveer Institute of Science & Technology,
Vysapur, Bandlaguda, Keshavnagar,
Hyderabad - 500 005.

**DEPARTMENT OF ELECTRICAL & ELECTRONICS****SYLLABUS FOR Plc Programming**

SNO	TOPIC COVERED	DURATION
1	Introduction	3
2	Plc	3
3	Des	3
4	Relays	3
5	Plc ranges	3
6	Basic ladder logic	3
7	Logic function	3
8	Electrical wiring diagrams	3
9	Scan cycles	3
10	Timer counter instruction	3
11	Registers/buses	3
12	Interfacing	3

M. Srinivasulu Reddy
 INSTITUTE OF SCIENCE & TECHNOLOGY
 Bandlaguda, Hyd-500 005

R.V. Anasalt
 HOD-EEE

Professor & Head
 Dept. of Electrical & Electronics Engineering
 Institute of Science & Technology
 Bandlaguda, Keshavnagar,
 Hyderabad-500 005

Vysapuri, Bandlaguda Post, Keshavgiri,

MAHAVEER



Hyderabad-500 005, TELANGANA INDIA

Tel: 040-64596979, 8978380692 Fax: 040-24455903

E-mail: e3hod.eee@gmail.com

Website: www.mist.ac.in,

Approved by AICTE, Affiliated to JNTUH Hyd

DEPARTMENT OF ELECTRICAL & ELECTRONICS

LIST OF REGISTERED STUDENTS FOR Plc Programming

SNO	HALL TICKET NO	NAME OF THE STUDENT
1	16E31A0201	ABDUL RAHMAN
2	16E31A0202	AKKALADEVI RAMYASRI
3	16E31A0204	BANOTH PRAVEENKUMAR
4	16E31A0205	BEJAWADA SANDEEP
5	16E31A0206	BYRANAGARANI
6	16E31A0207	DESHWAL VINEET
7	16E31A0208	EEGA PRACHYUTH
8	16E31A0209	GUDAPATI VEENA
9	16E31A0210	JADAV SATHISH
10	16E31A0211	JYESTA RAJESWARI
11	16E31A0212	K V LRESH
12	16E31A0213	KARLAGNANAPRASUNA
13	16E31A0214	MANDADI SOUNDARYA
14	16E31A0218	MEGAVATH PAVAN KUMAR
15	16E31A0221	MS MANSHI DUBEY
16	16E31A0223	PINREDDY AJITH REDDY
17	16E31A0224	PITTLA PAVAN KALYAN
18	16E31A0225	PUNNA VAISHNAVI
19	16E31A0226	RAJARAPU VIJAY
20	16E31A0227	RENDLA RANJITH
21	16E31A0228	ROSHAN PATNAIK
22	16E31A0229	SANABOINA KRISHNAVAMSI
23	16E31A0230	SHIRAM SHELTY SAIKUMAR
24	16E31A0231	UPPUNUTALA ARUN KUMAR
25	15E31A0215	A HRUSHIKESH
26	17E35A0201	ARMIRAVIVANSHI
27	17E35A0202	ARUN KUMAR
28	17E35A0203	DEVATHA PAVANI
29	17E35A0204	CHOPPAR ABHINAV
30	17E35A0205	DRONGALANARISHI
31	17E35A0206	EGURE L MADHU
32	17E35A0207	GADIDASULA NARESH
33	17E35A0208	KALLEPALLY KEERTHANA
34	17E35A0209	MUNISHETTI NIHARIKA
35	17E35A0210	NAMPELLY NIKHIL
36	17E35A0211	PATHIPAKA SAIKIRAN
37	17E35A0212	YADAGIRI LALITH KUMAR

Khandu

PRINCIPAL

MAHAVEER

INSTITUTE OF SCIENCE & TECHNOLOGY

Bandlaguda, Hyd-500 005



DEPARTMENT OF ELECTRICAL & ELECTRONICS

PLC PROGRAMMING QUESTION PAPER

Duration: 120 Minutes

4 X 5 = 20 Marks

Answer the following all questions. Each question carries 5 marks.

1. Which programmable languages are used in PLCs?
2. Differentiate between PLCs and DCS.
3. Differentiate between PLCs and Relays.
4. Which PLC ranges are available in Rockwell?

R.V Amrath
HOD-EEE

Professor & Head
Dept of Electrical & Electronics Engg
Mahaveer Institute of Science & Technology
Vysapuri, Bandlaguda, Keshavgi,
Hyderabad - 500 005.

K. S. S. S.
PRINCIPAL
MAHAVEER
INSTITUTE OF SCIENCE & TECHNOLOGY
Bandlaguda, Hyd-500 005.

**DEPARTMENT OF ELECTRICAL & ELECTRONICS****RESULT SHEET FOR PLC PROGRAMMING REGISTERED STUDENTS**

SNO	HALL TICKET NO	NAME OF THE STUDENT	MARKS (20)	RESULT
1	16E31A0201	ABDUL RAHEMAN	20	PASS
2	16E31A0202	AKKALADEVI RAMYASRI	19	PASS
3	16E31A0204	BANOTH PRAVEENKUMAR	20	PASS
4	16E31A0205	BEJAWADA SANDEEP	18	PASS
5	16E31A0206	BYRA NAGARANI	20	PASS
6	16E31A0207	DESHWAL VINEET	20	PASS
7	16E31A0208	EEGA PRACHYUTH	16	PASS
8	16E31A0209	GUDAPATI VEENA	20	PASS
9	16E31A0210	JADAV SATHISH	20	PASS
10	16E31A0211	JYESTA RAJESWARI	17	PASS
11	16E31A0212	K VEERESH	20	PASS
12	16E31A0213	KARLA GNANAPRASUNA	20	PASS
13	16E31A0214	MANDADI SOUNDARYA	16	PASS
14	16E31A0218	MEGAVATH PAVAN KUMAR	20	PASS
15	16E31A0221	MS MANSHI DUBEY	20	PASS
16	16E31A0223	PINREDDY AITH REDDY	18	PASS
17	16E31A0224	PILLALA PAVAN KALYAN	20	PASS
18	16E31A0225	PUNNA VAISHNAVI	19	PASS
19	16E31A0226	RAJARAPU VIJAY	20	PASS
20	16E31A0227	RENDLA RANJITH	18	PASS
21	16E31A0228	ROSHAN PATNAIK	20	PASS
22	16E31A0229	SANABOINA KRISHNAVAMSI	20	PASS
23	16E31A0230	SHIRAM SHETTY SAIKUMAR	16	PASS
24	16E31A0231	UPPUNUTALA ARUN KUMAR	20	PASS
25	15E31A0215	A HRESHIKESH	20	PASS
26	17E35A0201	ARJUN ANJANSHU	20	PASS
27	17E35A0202	CHANDRASEKHAR	18	PASS
28	17E35A0203	BANDI VASAVI	19	PASS
29	17E35A0204	CHOPPARI ABHIRASHI	18	PASS
30	17E35A0205	DONGAL VARISHI	17	PASS
31	17E35A0206	EGURI MADHU	19	PASS
32	17E35A0207	GADIDASULA NARESH	20	PASS
33	17E35A0208	KALLEPALLY KEERTHANA	19	PASS
34	17E35A0209	MUNISHETTI NIHARIKA	20	PASS
35	17E35A0210	NAMPELLY NIKHIL	18	PASS
36	17E35A0211	PATHIPAKA SAIKIRAN	20	PASS
37	17E35A0212	YADAGIRI LALITH KUMAR	20	PASS

No. of students Registered:37

No. of students Passed:37

No. of students failed:NIL

2016-17
2016-17
2016-17

Vysapuri, Bandlaguda Post, Keshavnagar

MAHAVEER



Hyderabad-500 005, TELANGANA INDIA

Tel: 040-64596979, 8978380692 Fax: 040-24455903

E-mail: e3hod.eee@gmail.com

Website: www.mist.ac.in

Approved by AICTE. Affiliated to JNTUH Hyd

DEPARTMENT OF ELECTRICAL & ELECTRONICS

SUMMARY REPORT OF PLC PROGRAMME

- Programmable Logic Controller (PLC) or programmable controller is a **digital computer used for automation of electromechanical processes** such as control of machinery on factory assembly lines, amusement rides, or light fixtures. PLCs are used in many industries and machines.

COORDINATOR

Copy to

1. Department Notice Board
2. Principal for Information
3. Committee Members (Academic)



Principal,
MAHAVEER
INSTITUTE OF TECHNOLOGY AND ENGINEERING
Bandlaguda, Hyd-500 005.

2. PLC Programming(3-1)

SNO	HALL TICKET	NAME OF THE STUDENT	1	2	3	4	5	6	7	8	9	10	11	12	13	14	15	16	17	18	19
7	16F31A0201	ABDUL RAHMAN	P	P	P	P	P	P	P	P	P	P	P	P	P	P	P	P	P	P	P
	16F31A0202	AKKALADEVARAJU SHI	P	P	P	P	P	P	P	P	P	P	P	P	P	P	P	P	P	P	P
	16F31A0204	BANGOTHI PRAVEEN KUMAR	P	P	P	P	P	P	P	P	P	P	P	P	P	P	P	P	P	P	P
	16F31A0206	BYRANAGARANI	P	P	P	P	P	P	P	P	P	P	P	P	P	P	P	P	P	P	P
	16F31A0207	DESIWAL VINITH	P	P	P	P	P	P	P	P	P	P	P	P	P	P	P	P	P	P	P

6	16F31A0208	EFGA PRACHIYITHI	P	P	P	P	P	P	P	P	P	P	P	P	P	P	P	P	P	P	P
7	16F31A0209	GUDDAPATI VEENA	P	P	P	P	P	P	P	P	P	P	P	P	P	P	P	P	P	P	P
8	16F31A0210	JADAV SATHISH	P	P	P	P	P	P	P	P	P	P	P	P	P	P	P	P	P	P	P
9	16F31A0211	JYESTAJARAJESWARATHI	P	P	P	P	P	P	P	P	P	P	P	P	P	P	P	P	P	P	P
10	16F31A0212	K VEERESH	P	P	P	P	P	P	P	P	P	P	P	P	P	P	P	P	P	P	P
11	16F31A0213	KARLAGANAPRASANA	P	P	P	P	P	P	P	P	P	P	P	P	P	P	P	P	P	P	P
12	16F31A0214	MANDADESOUNDHARANA	P	P	P	P	P	P	P	P	P	P	P	P	P	P	P	P	P	P	P
13	16F31A0218	MIGAVATHIPAVANA	P	P	P	P	P	P	P	P	P	P	P	P	P	P	P	P	P	P	P
14	16F31A0221	MIS MANSHEE DEBI	P	P	P	P	P	P	P	P	P	P	P	P	P	P	P	P	P	P	P
15	16F31A0223	PINREDDY AJITHREDDY	P	P	P	P	P	P	P	P	P	P	P	P	P	P	P	P	P	P	P
16	16F31A0224	PIJITAPAVAN KAVANA	P	P	P	P	P	P	P	P	P	P	P	P	P	P	P	P	P	P	P
17	16F31A0225	PUNNAVAISHANATHI	P	P	P	P	P	P	P	P	P	P	P	P	P	P	P	P	P	P	P
18	16F31A0226	RAJARAJA VIDYA	P	P	P	P	P	P	P	P	P	P	P	P	P	P	P	P	P	P	P
19	16F31A0227	RENDI ARANJITHI	P	P	P	P	P	P	P	P	P	P	P	P	P	P	P	P	P	P	P
20	16F31A0228	ROSIJAN PATNAIK	P	P	P	P	P	P	P	P	P	P	P	P	P	P	P	P	P	P	P
21	16F31A0229	SANABOINA	P	P	P	P	P	P	P	P	P	P	P	P	P	P	P	P	P	P	P
22	17F35A0201	ARMUR AVINASHI	P	P	P	P	P	P	P	P	P	P	P	P	P	P	P	P	P	P	P
23	17F35A0202	AVANIGANTI SATHISHI	P	P	P	P	P	P	P	P	P	P	P	P	P	P	P	P	P	P	P
24	17F35A0203	BANDI APAVANI	P	P	P	P	P	P	P	P	P	P	P	P	P	P	P	P	P	P	P
25	17F35A0204	CHOPPARABHIVANSHI	P	P	P	P	P	P	P	P	P	P	P	P	P	P	P	P	P	P	P
26	17F35A0205	DONGALA NARESHI	P	P	P	P	P	P	P	P	P	P	P	P	P	P	P	P	P	P	P
27	17F35A0206	EGURLA MADHII	P	P	P	P	P	P	P	P	P	P	P	P	P	P	P	P	P	P	P
28	17F35A0207	GADIDASULA NARESHI	P	P	P	P	P	P	P	P	P	P	P	P	P	P	P	P	P	P	P
29	17F35A0208	KALIPALLY KIRITJAN	P	P	P	P	P	P	P	P	P	P	P	P	P	P	P	P	P	P	P
30	17F35A0209	MUNISHETTI NIBHARANA	P	P	P	P	P	P	P	P	P	P	P	P	P	P	P	P	P	P	P
31	17F35A0210	NAMPALLY NIKITHI	P	P	P	P	P	P	P	P	P	P	P	P	P	P	P	P	P	P	P
32	17F35A0211	PATHIPAKA SAKIRJAN	P	P	P	P	P	P	P	P	P	P	P	P	P	P	P	P	P	P	P
33	17F35A0212	YADAGRETHATHI KUMARI	P	P	P	P	P	P	P	P	P	P	P	P	P	P	P	P	P	P	P
34	16F35A0202	ERRALI A DEEPAK	P	P	P	P	P	P	P	P	P	P	P	P	P	P	P	P	P	P	P

Signature of the Faculty

MAHAVEER INSTITUTE OF SCIENCE ANDTECHN



ESTD 2001

(Affiliated to JNTUH, Hyderabad and Approved by AICTE, New Delhi)
Vyasapuri, Bandlaguda, Post: Keshavagiri, Hyderabad - 500005

organized by

Department of Electrical and Electronics Engineering

CERTIFICATE

This is certify that Gudapati Veena bearing Hall Ticket No 16E31A0
B.Tech Third Year has Participated in PLC Programming Train
Program From 11-09-2018 to 24-09-2018 organized by Departmen
Electrical and Electronics Engineering.

Dr. R. V. Amarnath

HOD

Dr.R.V.Amarnath

Dr. M. Sudhakaran

Dr.M.Sudhakaran

MIST

Dr. K. S. S. S. R

PRINCIPAL

Dr.K.S.S.S.R

MAHAVEER

Approved by AICTE, Affiliated to JNTU-Hydr.



A Two weeks certificate
course on
-PLC Programming-



Resource Person:
Dr. M. Sudhakaran

Schedule
From 9:00 AM to 12:00 PM
Timings: 16:00 am to 12:00 pm

Organized By
Department of
EEE Engineering

Organized Committee:

Chief Patron:

Sri S. Sudeshan Reddy, Chairman
Sri S. Sunder Reddy, Secretary

Patron:

Dr. K. S. S. N. Reddy, Principal

Academic Advisor:

Dr. H. S. N. Murthy, Director

Convener:

Dr. R. V. Anuradha Professor & HOD, Dept. of
EEE Engineering

Co-Conveners (contact for details):

Mr.

P. V. V. Sanyasuriya, Professor

Mr. G. Prem Kumar Reddy, Assistant Professor

Program Coordinators:

1. Mr. Jyothir Ma, Assistant Professor

2. Mr. B. Santhi, Assistant Professor

3. Ms. Kalyani, Assistant Professor

4. Mr. A. Mahesh Kumar, Assistant Professor

5. Mrs. B. Divya, Assistant Professor

Contact Details:

Feedback link: ourquarter@mahaveer.org

Email: eee@mahaveer.org or

Contact: 9989944464 | 78309446628

Absorb the College:

Mahaveer Institute of Science & Technology (MIST)

established in the year 2001 by

Mahaveer Educational Society, MIST offering B.Tech

Programs.

6PC Programs and 5 Diploma courses. Assisting in

promoting quality education. MIST annual

providing learning with technology-

edge 1 week diploma preparation for successful

placement education and Training, so that

you will have the required knowledge, skills and a

high level of self-

Absorb the Department:

The Department of Electrical & Electronics Engineering was established in 2001 which offers B.Tech. and M.Tech (POWER Engineering and Energy Systems) courses with highly qualified dedicated and motivated faculty. The courses and programmes offered by the department are of high technical expertise in the subject. We also give a professional exposure.

Topics to be covered:

- Introduction
- PLC
- Des
- Relays
- Basic ladder logic
- Logic function
- Electrical wiring diagrams
- Scan cycles
- Timer counter instruction
- Registers bases

Absorb the FDP:

Programs to be covered: PLC
Introduction, Ladder logic, Relay
logic, Electrical wiring diagrams,
Scan cycles, Timer counter instruction,
Registers bases, applications
of PLC in industry.

Vysapuri, Bandlaguda Post:Keshavgiiri,

MAHAVEER



Hyderabad-500 005, TELANGANA INDIA
Tel: 040-64596979,8978380692, Fax: 040-24455903
E-mail: e3hod.eee@gmail.com,
Website: www.mist.ac.in,

INSTITUTE OF SCIENCE & TECHNOLOGY
Approved by AICTE, Affiliated to JNTUH,Hyd.

DEPARTMENT OF ELECTRICAL & ELECTRONICS

Date: 10-02-2019

To
The Principal,
Mist,
Hyderabad.

Sub:Proposal for Add on course-Reg.

Respected sir,

We are going to conduct two weeks workshop on **ELECTRICAL ENERGY MANAGEMENT**. We require your approval to go head for further proceeding and hope to get an opportunity to serve you the best.

With thanks and regards

HOD-EEE

Professor & Head
Dept. of Electrical & Electronics
Mahaveer Institute of Science & Techno
Vysapuri, Bandlaguda, Keshavgiiri,
Hyderabad - 500 005.

PRINCIPAL
MAHAVEER
INSTITUTE OF SCIENCE & TECHNOLOGY
Bandlaguda, Hyd-500 005.

Vysapuri, Bandlaguda Post:Keshavgiri,

MAHAVEER



Hyderabad-500 005, TELANGANA INDIA

Tel: 040-64596979,8978380692, Fax: 040-24455903

E-mail: e3hod.eee@gmail.com,

Website: www.mist.ac.in,

Approved by AICTE, Affiliated to JNTUH,Hyd.

DEPARTMENT OF ELECTRICAL & ELECTRONICS

Date: 10-02-2019

CIRCULAR

Technical Trainings for II B. Tech students are starting from 20-02-2019 onwards. All HODs and placements coordinators have to manage the trainings and ensure 95% attendance all through the sessions.

All mentors need to send the compiled feedback report to HOD at e3hod.eee@gmail.com daily. Mentors are advised to take care of PNR (Students not participating in training).

Agenda: Electrical Energy Management

Design & Development of Curriculum for Add on Courses Faculty Names 1.Dr M Sudakaran

2.G.Prem kumar Reddy

PRINCIPAL
MAHAVEER
INSTITUTE OF SCIENCE & TECHNOLOGY
Bandlaguda, Hyd-500 005.

HOD-EEE

Dr. M. RAJENDAR REDDY, M.Tech., Ph.
Professor & Head
Dept. of Electrical & Electronics Engg
Mahaveer Institute of Science & Technology
Vysapuri, Bandlaguda, Keshavgiri,
Hyderabad - 500 005.

Vysapuri, Bandlaguda Post:Keshavgi,

MAHAVEER



Hyderabad-500 005, TELANGANA INDIA

Tel: 040-64596979,8978380692,Fax: 040-24455003

E-mail: e3hod.eee@gmail.com,

Website: www.mist.ac.in,

Approved by AICTE, Affiliated to JNTUH,Hyd.

DEPARTMENT OF ELECTRICAL & ELECTRONICS

SYLLABUS FOR Electrical Energy Management

SNO	TOPIC COVERED	DURATION
1	Introduction	3
2	Classify Energy Storage systems	3
3	monitor and control of Energy Management Systems?	3
4	objective of Energy Management Systems?	3
5	Elements of Energy Management System	3
6	Energy management (audit) approach understanding energy costs	3
7	energy performance	3
8	optimizing the input energy requirements	3
9	energy audit instruments	3
10	Material and Energy balance	3
11	material and energy balance diagrams.	3

PRINCIPAL
M. MAHAVEER
INSTITUTE OF SCIENCE & TECHNOLOGY
Bandlaguda, Hyd-500 005.

HOD-EEE

Dr. M. RAJENDAR REDDY, M.Tech., Ph.D.
Professor & Head
Dept. of Electrical & Electronics Engg
Mahaveer Institute of Science & Technol
Vysapuri, Bandlaguda, Keshavgi,
Hyderabad - 500 005.

Vysapuri, Bandlaguda Post:Keshavgiri,

MAHAVEER



Hyderabad-500 005, TELANGANA INDIA

Tel: 040-64596979,8978380692,Fax: 040-24455903

E-mail: e3hod.eee@gmail.com,

Website: www.mist.ac.in,

Approved by AICTE, Affiliated to JNTUH,Hyd.

DEPARTMENT OF ELECTRICAL & ELECTRONICS

LIST OF REGISTERED STUDENTS FOR Electrical Energy Management

SNO	HALL TICKET NO	NAME OF THE STUDENT
1	17E31A0201	A S OM SAI KIRAN
2	17E31A0202	ANUPA VIKRAM
3	17E31A0203	APAKA ARAVIND
4	17E31A0204	BADAM RAHUL
5	17E31A0205	BHUKYA YASHWANTH
6	17E31A0206	BODDU HARIKRISHNA
7	17E31A0207	CHIDUMULA APARNA
8	17E31A0208	GADILA SAI KIRAN
9	17E31A0209	GAJJALA SAI SREEYA
10	17E31A0210	GONEGANDLA KIRANKUMAR
11	17E31A0211	GULLA SRILATHA
12	17E31A0212	KAITHA SANDEEP
13	17E31A0213	KARUMURI VENKATA RAMA DATTA ADITYA
14	17E31A0215	KELOTH SANTOSH
15	17E31A0216	KODELA VINEETH
16	17E31A0217	KONGARI PAVAN KUMAR
17	17E31A0218	LAKAYATH RAVI
18	17E31A0219	MALKAGIRI RAKESH
19	17E31A0220	MALLEPALLY SREE CHANDANA
20	17E31A0221	MASIREDDY VEERA REDDY
21	17E31A0223	SHAIK NAZEEMPASHA
22	17E31A0224	SIRISHETTI SHASHANK
23	17E31A0225	SYED ZAFAR
24	17E31A0226	THAKKALAPPELLY RAKSHITHA
25	17E31A0227	THIMMAPATI RAVI SUSHMA
26	17E31A0230	YANKUDOTH HARI
27	18E35A0201	AJAY BABU 'A'
28	18E35A0202	ANANTHULA MARUTHI
29	18E35A0203	BANDARU ANUSHA
30	18E35A0204	BAKARAPU NAVYA
31	18E35A0205	BOJJA VAISHNAVI
32	18E35A0206	BURA SRIDHAR
33	18E35A0207	DUMPALA SWETHA
34	18E35A0208	G JAY SHIVA
35	18E35A0209	KORRA SINDHU
36	18E35A0210	KUNARAPU SANDEEP
37	18E35A0211	M PRANTHA
38	18E35A0212	MADDELA NAVEEN GOUD
39	18E35A0213	MANCHOJU VENU

Kishor

PRINCIPAL
MAHAVEER
INSTITUTE OF SCIENCE & TECHNOLOGY
Bandlaguda, Hyd-500 005.

Vysapuri, Bandlaguda Post:Keshavgiri,

MAHAVEER



Hyderabad-500 005, TELANGANA INDIA

Tel: 040-64596979,8978380692,Fax: 040-24455003

E-mail: e3hod.eee@gmail.com,

Website: www.mist.ac.in,

Approved by AICTE, Affiliated to JNTUH,Hyd.

DEPARTMENT OF ELECTRICAL & ELECTRONICS

40	18E35A0214	PEDDASAYANNAGARU MAHENDAR REDDY
41	18E35A0215	RATLAVATH SINDU
42	18E35A0216	SINGANAMONI NAVANEETHA
43	18E35A0217	TANGELLA DURGA PAWAN KALYAN
44	18E35A0218	UPPULA ANIL KUMAR
45	16E31A0216	M RAGHAVENDER GOUD
46	16E31A0217	M DANISH PERWEZ

Rajendar

Dr. M. RAJENDAR REDDY, B.Tech.,
Professor & Head
Dept. of Electrical & Electronics Engg
Mahaveer Institute of Science & Tech
Vysapuri, Bandlaguda, Keshavgiri,
Hyderabad - 500 005.

Keshavi

PRINCIPAL,
MAHAVEER
INSTITUTE OF SCIENCE & TECHNOLOGY
Bandlaguda, Hyd-500 005.

Vysapuri, Bandlaguda Post:Keshavgi,

MAHAVEER



Hyderabad-500 005, TELANGANA INDIA

Tel: 040-64596979,8978380692,Fax: 040-24455903

E-mail: g3hod.eee@gmail.com.

Website: www.mist.ac.in,

Approved by AICTE, Affiliated to JNTUH,Hyd.

DEPARTMENT OF ELECTRICAL & ELECTRONICS

Electrical Energy Management QUESTION PAPER

Duration: 120 Minutes

4X 5 = 20 Marks

Answer the following all questions. Each question carries 5 marks.

1. Classify Energy Storage systems?
2. Explain the monitor and control of Energy Management Systems?
3. What are the main objective of Energy Management Systems?
4. Explain the elements of Energy Management System in detail?

HOD-EEE



PRINCIPAL
MAHAVEER
INSTITUTE OF SCIENCE & TECHNOLOGY
Bandlaguda, Hyc-500 005.

Dr. N. RAJENDAR REDDY, M.Tech.,
Professor & Head
Dept. of Electrical & Electronics En.
Mahaveer Institute of Science & Techno. - 4
Vysapuri, Bandlaguda, Keshavgi,
Hyderabad - 500 005.

Vysapuri, Bandlaguda Post:Keshavgi,

MAHAVEER



Hyderabad-500 005, TELANGANA INDIA

Tel: 040-64596979,8978380692,Fax: 040-24455903

E-mail: e3hod.eee@gmail.com,

Website: www.mist.ac.in,

Approved by AICTE, Affiliated to JNTUH,Hyd.

DEPARTMENT OF ELECTRICAL & ELECTRONICS

RESULT SHEET FOR Electrical Energy Management REGISTERED STUDENTS

SNO	HALL TICKET NO	NAME OF THE STUDENT	MARKS (20)	RESULT
1	17E31A0201	A S OM SAI KIRAN	20	PASS
2	17E31A0202	ANUPA VIKRAM	19	PASS
3	17E31A0203	APAKA ARAVIND	20	PASS
4	17E31A0204	BADAM RAHUL	18	PASS
5	17E31A0205	BHUKYA YASHWANTH	20	PASS
6	17E31A0206	BODDU HARIKRISHNA	20	PASS
7	17E31A0207	CHIDUMULA APARNA	16	PASS
8	17E31A0208	GADILA SAI KIRAN	20	PASS
9	17E31A0209	GAJJALA SAI SREEYA	20	PASS
10	17E31A0210	GONEGANDLA KIRANKUMAR	17	PASS
11	17E31A0211	GULLA SRILATHA	20	PASS
12	17E31A0212	KAITHA SANDEEP	20	PASS
13	17E31A0213	KARUMURI VENKATA RAMA DATTA ADITYA	16	PASS
14	17E31A0215	KELOTH SANTOSH	20	PASS
15	17E31A0216	KODELA VINEETH	20	PASS
16	17E31A0217	KONGARI PAVAN KUMAR	18	PASS
17	17E31A0218	LAKAVATH RAVI	20	PASS
18	17E31A0219	MALKAGIRI RAKESH	19	PASS
19	17E31A0220	MALLEPALLY SREE CHANDANA	20	PASS
20	17E31A0221	MASIREDDY VEERA REDDY	18	PASS
21	17E31A0223	SHAIK NAZEEMPASHA	20	PASS
22	17E31A0224	SIRISHETTI SHASHANK	20	PASS
23	17E31A0225	SYED ZAFAR	16	PASS
24	17E31A0226	THAKAL APULY RAKSHITHA	20	PASS
25	17E31A0227	THIMMAPURAM SUSHILA	20	PASS
26	17E31A0230	VANKUDOTH HARI	20	PASS
27	18E35A0201	AJAY BABUM	18	PASS
28	18E35A0202	ANANTHULA MARUTHI	20	PASS
29	18E35A0203	BANDARU ANUSILA	19	PASS
30	18E35A0204	BAKARAPU NAVYA	20	PASS
31	18E35A0205	BOJJA VAISHNAVI	18	PASS
32	18E35A0206	BURA SRIDHAR	20	PASS
33	18E35A0207	DUMPALA SWEETHA	20	PASS
34	18E35A0208	G JAY SHIVA	16	PASS
35	18E35A0209	KORRA SINDHU	20	PASS
36	18E35A0210	KUNARAPU SANDEEP	20	PASS
37	18E35A0211	M PRANITHA	17	PASS
38	18E35A0212	MADDELA NAVEEN GOUD	20	PASS

K. Srinivas

PRINCIPAL
MAHAVEER
INSTITUTE OF SCIENCE & TECHNOLOGY
Bandlaguda, Hyd-500 005.

Vysapuri, Bandlaguda Post:Keshavgiri,

MAHAVEER



Hyderabad-500 005, TELANGANA INDIA

Tel: 040-64596979,8978380692,Fax: 040-24455003

E-mail: c3hod.eee@gmail.com

Website: www.mist.ac.in

Approved by AICTE, Affiliated to JNTUH,Hyd.

DEPARTMENT OF ELECTRICAL & ELECTRONICS

39	18E35A0213	MANCHOJU VENU	20	PASS
40	18E35A0214	PEDDASAYANNAGARU	16	PASS
41	18E35A0215	MAHENDAR REDDY		
		RATLAYATH SINDU	20	PASS
42	18E35A0216	SINGANAMONI	20	PASS
		NAVANEETHA		
43	18E35A0217	TANGELLA DURGA PAWAN	18	PASS
44	18E35A0218	KALYAN		
		UPPULA ANIL KUMAR	20	PASS
45	16E31A0216	M RAGHAVENDER GOUD	19	PASS
46	16E31A0217	M DANISH PERWEZ	20	PASS

No. of students Registered:46

No. of students Passed:46

No. of students failed:NIL

Dr. M. RAJENDAR REDDY, M.Tech., Ph.D.
Professor & Head

Dept. of Electrical & Electronics Engg
Mahaveer Institute of Science & Technology
Vysapuri, Bandlaguda, Keshavgiri,
Hyderabad - 500 005.

PRINCIPAL
MAHAVEER
INSTITUTE OF SCIENCE & TECHNOLOGY
Bandlaguda, Hyd-500 005.

Vysapuri, Bandlaguda Post:Keshavgiri,

MAHAVEER



Hyderabad-500 005, TELANGANA INDIA

Tel: 040-64596979,8978380692.Fax: 040-24455003

E-mail: e3hod.eee@gmail.com.

Website: www.mist.ac.in,

Approved by AICTE. Affiliated to JNTUH,Hyd.

DEPARTMENT OF ELECTRICAL & ELECTRONICS

SUMMARY REPORT OF Electrical Energy Management

- Electrical Energy Management System (EEMS) widely refers to a computer system which is designed specifically for the automated control and monitoring of electric power and utility system. The scope may span from a load dispatch center to a group of power networks.

Pring
COORDINATOR

Copy to:

1. Department Notice Board
2. Principal for Information
3. Committee Members (Academic)

Kishu

PRINCIPAL
MAHAVEER
INSTITUTE OF SCIENCE & TECHNOLOGY
Bandlaguda, Hyd-500 005.

Date: 17/08/2023

5. Electrical Energy Management (2:2)			1	2	3	4	5	6	7	8	9	10	11	12	13	14	15	16	17	18	19	20	21	22	23	24	25	26	27	28	29	30	
SNO	HALL TICKET	NAME OF THE STUDENT																															
1	17E31A0201	A S O M SAI KIRAN	P	P	P	P	P	P	P	P	P	P	P	P	P	P	P	P	P	P	P	P	P	P	P	P	P	P	P	P	P	P	
2	17E31A0202	ANUPA VIKRAM	P	P	P	P	P	P	P	P	P	P	P	P	P	P	P	P	P	P	P	P	P	P	P	P	P	P	P	P	P	P	
3	17E31A0203	APAKA ARAVIND	P	P	P	P	P	P	P	P	P	P	P	P	P	P	P	P	P	P	P	P	P	P	P	P	P	P	P	P	P	P	
4	17E31A0204	BADAM RAHUL	P	P	P	P	P	P	P	P	P	P	P	P	P	P	P	P	P	P	P	P	P	P	P	P	P	P	P	P	P	P	
5	17E31A0205	BHUKYA YASIWANTH	P	P	P	P	P	P	P	P	P	P	P	P	P	P	P	P	P	P	P	P	P	P	P	P	P	P	P	P	P	P	
6	17E31A0206	BODDU HARIKRISHNA	P	P	P	P	P	P	P	P	P	P	P	P	P	P	P	P	P	P	P	P	P	P	P	P	P	P	P	P	P	P	
7	17E31A0207	CHIDUMULA APARNA	P	P	P	P	P	P	P	P	P	P	P	P	P	P	P	P	P	P	P	P	P	P	P	P	P	P	P	P	P	P	
8	17E31A0208	GADILA SAIKIRAN	P	P	P	P	P	P	P	P	P	P	P	P	P	P	P	P	P	P	P	P	P	P	P	P	P	P	P	P	P	P	
9	17E31A0209	GAJALA SAI SREYA	P	P	P	P	P	P	P	P	P	P	P	P	P	P	P	P	P	P	P	P	P	P	P	P	P	P	P	P	P	P	
10	17E31A0210	GONEGANDLA	P	P	P	P	P	P	P	P	P	P	P	P	P	P	P	P	P	P	P	P	P	P	P	P	P	P	P	P	P	P	
11	17E31A0211	GULLA SRI LATHA	P	P	P	P	P	P	P	P	P	P	P	P	P	P	P	P	P	P	P	P	P	P	P	P	P	P	P	P	P	P	
12	17E31A0212	KAITHA SANDEEP	P	P	P	P	P	P	P	P	P	P	P	P	P	P	P	P	P	P	P	P	P	P	P	P	P	P	P	P	P	P	
13	17E31A0213	KARUMURI VENKATA	P	P	P	P	P	P	P	P	P	P	P	P	P	P	P	P	P	P	P	P	P	P	P	P	P	P	P	P	P	P	
14	17E31A0215	KELOTHI SANTOSH	P	P	P	P	P	P	P	P	P	P	P	P	P	P	P	P	P	P	P	P	P	P	P	P	P	P	P	P	P	P	
15	17E31A0216	KOOFELA VINETHI	P	P	P	P	P	P	P	P	P	P	P	P	P	P	P	P	P	P	P	P	P	P	P	P	P	P	P	P	P	P	
16	17E31A0217	KONGARI PAVAN KUMAR	P	P	P	P	P	P	P	P	P	P	P	P	P	P	P	P	P	P	P	P	P	P	P	P	P	P	P	P	P	P	
17	17E31A0218	LAKAVATH RAVI	P	P	P	P	P	P	P	P	P	P	P	P	P	P	P	P	P	P	P	P	P	P	P	P	P	P	P	P	P	P	
18	17E31A0219	MALKAGIRI RAKESH	P	P	P	P	P	P	P	P	P	P	P	P	P	P	P	P	P	P	P	P	P	P	P	P	P	P	P	P	P	P	
19	17E31A0220	MALLEPALLY SREE	P	P	P	P	P	P	P	P	P	P	P	P	P	P	P	P	P	P	P	P	P	P	P	P	P	P	P	P	P	P	
20	17E31A0221	MASIREDDY VEERA REDDY	P	P	P	P	P	P	P	P	P	P	P	P	P	P	P	P	P	P	P	P	P	P	P	P	P	P	P	P	P	P	
21	17E31A0223	SHAIK NAZEEM PASHA	P	P	P	P	P	P	P	P	P	P	P	P	P	P	P	P	P	P	P	P	P	P	P	P	P	P	P	P	P	P	
22	17E31A0224	SIRISHETTI SHASHANK	P	P	P	P	P	P	P	P	P	P	P	P	P	P	P	P	P	P	P	P	P	P	P	P	P	P	P	P	P	P	
23	17E31A0225	SYED ZAFAR	P	P	P	P	P	P	P	P	P	P	P	P	P	P	P	P	P	P	P	P	P	P	P	P	P	P	P	P	P	P	
24	17E31A0226	THAKKALAPALLY	P	P	P	P	P	P	P	P	P	P	P	P	P	P	P	P	P	P	P	P	P	P	P	P	P	P	P	P	P	P	
25	17E31A0227	THIMMAPURAN SUSHIMA	P	P	P	P	P	P	P	P	P	P	P	P	P	P	P	P	P	P	P	P	P	P	P	P	P	P	P	P	P	P	
26	17E31A0230	VANKUDOTH HARI	P	P	P	P	P	P	P	P	P	P	P	P	P	P	P	P	P	P	P	P	P	P	P	P	P	P	P	P	P	P	
27	18E35A0201	K JAY BABU M	P	P	P	P	P	P	P	P	P	P	P	P	P	P	P	P	P	P	P	P	P	P	P	P	P	P	P	P	P	P	
28	18E35A0202	ANANTHULA MARUTHI	P	P	P	P	P	P	P	P	P	P	P	P	P	P	P	P	P	P	P	P	P	P	P	P	P	P	P	P	P	P	
29	18E35A0203	BANDARU ANUSHA	P	P	P	P	P	P	P	P	P	P	P	P	P	P	P	P	P	P	P	P	P	P	P	P	P	P	P	P	P	P	
30	18E35A0204	BAKARAPU NAVYA	P	P	P	P	P	P	P	P	P	P	P	P	P	P	P	P	P	P	P	P	P	P	P	P	P	P	P	P	P	P	
31	18E35A0205	BOJJA VAISHNAVI	P	P	P	P	P	P	P	P	P	P	P	P	P	P	P	P	P	P	P	P	P	P	P	P	P	P	P	P	P	P	
32	18E35A0206	BURA SRIDHAR	P	P	P	P	P	P	P	P	P	P	P	P	P	P	P	P	P	P	P	P	P	P	P	P	P	P	P	P	P	P	
33	18E35A0207	DUMPALA SWETHA	P	P	P	P	P	P	P	P	P	P	P	P	P	P	P	P	P	P	P	P	P	P	P	P	P	P	P	P	P	P	
34	18E35A0208	G JAY SHIVA	P	P	P	P	P	P	P	P	P	P	P	P	P	P	P	P	P	P	P	P	P	P	P	P	P	P	P	P	P	P	
35	18E35A0209	KORRA SINDHU	P	P	P	P	P	P	P	P	P	P	P	P	P	P	P	P	P	P	P	P	P	P	P	P	P	P	P	P	P	P	
36	18E35A0210	KUNARAPU SANDIPTA	P	P	P	P	P	P	P	P	P	P	P	P	P	P	P	P	P	P	P	P	P	P	P	P	P	P	P	P	P	P	
37	18E35A0211	M PRANITHA	P	P	P	P	P	P	P	P	P	P	P	P	P	P	P	P	P	P	P	P	P	P	P	P	P	P	P	P	P	P	
38	18E35A0212	MADDELA NAVEEN	P	P	P	P	P	P	P	P	P	P	P	P	P	P	P	P	P	P	P	P	P	P	P	P	P	P	P	P	P	P	
39	18E35A0213	MANCHOTHU VENU	P	P	P	P	P	P	P	P	P	P	P	P	P	P	P	P	P	P	P	P	P	P	P	P	P	P	P	P	P	P	
40	18E35A0214	PEDDASAYANNAGARI	P	P	P	P	P	P	P	P	P	P	P	P	P	P	P	P	P	P	P	P	P	P	P	P	P	P	P	P	P	P	
41	18E35A0215	RATLAVATHI SINHU	P	P	P	P	P	P	P	P	P	P	P	P	P	P	P	P	P	P	P	P	P	P	P	P	P	P	P	P	P	P	
42	18E35A0216	SINGANAMONI	P	P	P	P	P	P	P	P	P	P	P	P	P	P	P	P	P	P	P	P	P	P	P	P	P	P	P	P	P	P	
43	18E35A0217	TANGELLA DURGA	P	P	P	P	P	P	P	P	P	P	P	P	P	P	P	P	P	P	P	P	P	P	P	P	P	P	P	P	P	P	
44	18E35A0218	UPPULA ANIL KUMAR	P	P	P	P	P	P	P	P	P	P	P	P	P	P	P	P	P	P	P	P	P	P	P	P	P	P	P	P	P	P	
45	18E35A0219	M RAGHAVENDER GOUD	P	P	P	P	P	P	P	P	P	P	P	P	P	P	P	P	P	P	P	P	P	P	P	P	P	P	P	P	P	P	
46	18E35A0217	M DANISH PERWEZ	P	P	P	P	P	P	P	P	P	P	P	P	P	P	P	P	P	P	P	P	P	P	P	P	P	P	P	P	P	P	
		Signature of the Faculty																															

R.V. Amath
 Professor & Head
 Dept. of Electrical & Electronics
 Jawahar Institute of Science & Tech.
 Vyasaiah, Bandlaguda, Reshmy
 Hyderabad - 500 005.

MAHAVEER INSTITUTE OF SCIENCE AND TECHNOLOGY

(Affiliated to JNTUH, Hyderabad and Approved by AICTE, New Delhi)
Vyasapuri, Bandlaguda, Post: Keshavagiri, Hyderabad- 500005



ESTD : 2001

organized by

Department of Electrical and Electronics Engineering

CERTIFICATE

This is certify that **Malkagiri Rakesh** bearing Hall Ticket No 17E31A0
B.Tech Second Year has Participated in **Electrical Energy Manager**
Training Program From 20-02-2019 to 08-03-2019 organized by Depa
of **Electrical and Electronics Engineering.**

Dr. R. V. Amarnath

HOD

Dr.R.V.Amarnath

Dr. M. Rajendar Reddy

Dr.M.Rajendar Reddy

MIST

Dr. K. S. S. S. Prasad

PRINCIPAL

Dr.K.S.S.S.P.

About the college:

As an Institute committed to quality education, MIST aims at providing learning with a Technology-edge. It endeavors to provide consistent training to its students to help them evolve as competent professionals in the highly competitive world. Right from its inception in 2001, it has been tuning itself to meet this objective. A new civilization is emerging in our lives. This new civilization brings with it a new way of working. Millions are already tuning their lives to the rhythms of consumerism.

About EEE Department:

The Department of E.E.E is working with a mission to contribute through excellence in technical education, with research orientation. It imparts ethical & moral values to the student's so as to make them emerge as responsible professionals. With its experienced faculty members having excellent academic backgrounds, it trains students supplementing classroom lectures with computer aided demonstrations making their learning a rich and rewarding experience.

Resource Person:

Dr. M. Rajendar Reddy,
MIST



Dept. of Electrical & Electronics Engineering
Mahaveer Institute of Science & Technology

Venugopuri, Bandlaguda, Hyderabad 500005.
(Affiliated to JNTUH)

Chief Patron:

Smt. S. Jayalaxmi Reddy, Chairman
Sri S. Surendar Reddy, Secretary
Sri S. Dharmaraj Reddy, Joint Secretary

Patron:

Dr. K. S. S. N. Reddy, Principal

Academic Advisor:

Dr. H. S. N. Murthy, Director

Topics:

Introduction

Classify Energy Storage systems
monitor and control of Energy Management Systems

Objective of Energy Management Systems

Elements of Energy Management System

Energy management (audio)
approach understanding energy costs
energy performance

Optimizing the input energy requirements

Coventor:

Mr. P. V. V. S. Satyanarayana,
Professor & HOD, Dept of EEE Engineering

For Campus events contact for details)

1. Mr. G. Prem Kumar Reddy

2. Mr. A. Mahesh Kumar Assistant Professor

Program Coordinator:

1. Mr. G. H. Harisham Assistant Professor

2. Mr. B. Satish Assistant Professor

3. Mrs. Divya Assistant Professor

4. Mrs. Tulkeer Ayedha Assistant Professor

5. Mrs. K. S. Bharathi Assistant Professor

6. Mrs. T. Himabindu Assistant Professor

MAHAVEER

INSTITUTE OF SCIENCE & TECHNOLOGY
Approved by AICTE, Affiliated to JNTUH (MIST)

A Two week Certificate
Course on

ELECTRICAL ENERGY MANAGEMENT



From: 20th Feb to 8th
Mar-2019

Timings: 10:00 am to 3:00 pm

ORGANIZED BY

DEPARTMENT OF

EEE

About the College

As an Institute committed in quality education, MIST aims at providing learning with a Technology-edge. It endeavors to provide consistent training to its students to help them evolve as competent professionals in the highly competitive world. Right from its inception in 2001, it has been tuning itself to meet this objective. A new civilization is emerging in our lives. This civilization brings with it a new way of working. Millions are already tuning their lives to the rhythms of tomorrow.

About the Mechanical Department

The Mechanical engineering is one of the core engineering departments, which has potential to accommodate all efficient engineers. The Mechanical engineers serve all other branches of engineering directly or indirectly. The Mechanical engineers can find their place in Automobile engineering sector, Steel Plants, Power plants, Software industries, Manufacturing industries, Design industries, Military, Naval and Air force, Defense research organizations, Material research organizations etc.

About the Workshop

AutoCAD is globally used by surveyors, designers, engineers, drafters. Globally, AutoCAD has proven as an efficient and user-friendly Program. Program.Commercial drafting and computer-aided design(CAD) software applications are AutoCAD. AutoCAD software is recognized internationally for its remarkable editing capabilities, which make it likely to digitally draw building plans or recreate 3D images. AutoCAD is compatible with other applications like 3D Max. The designers can even import or export DWG & DXG Files to the application. Also, these files can even be exported from AutoCAD to other applications for creating more improved projects & presentations.

Organising committee

CHIEF PATRON

Smt. S. Jayalakshmi Reddy

Chairman

Sri. S. Surendar Reddy

Secretary

Sri S. Dhanunjay Reddy

Joint Secretary

DIRECTOR

Dr. H. S. N. Murthy

PATRON

Dr.K.S.S.Reddy, Principal

CONVENER

Dr.S.Murali,

Professor,Dept. Of Mechanical

PROGRAM COORDINATORS

Mr. B.Harinath Reddy

K.Devi Singh

Conducted On

1/5/2018- 11/5/2018



ETD - 2011

MAHAVEER
INSTITUTE OF SCIENCE & TECHNOLOGY

Approved by AICTE, Affiliated to JNTU, Hyderabad.
Visision, Bandipada, Text: Kapatla, Hyderabad-500065.



Two week
Certification Course
on

Auto CAD

Organized by

Department of Mechanical
Engineering

Vysapuri, Bandlaguda Post Keshavnagar,
Hyderabad-500 025, Telangana INDIA
Tel: 040-64556379, 30020773, Fax: 040-24455093
E-mail: principal@mahaveer@gmail.com
Website: www.mist.ac.in

MAHAVEER



Approved by AICTE, Affiliated to JNTU-Hyd

Date: 28-04-2018

To
The Principal
MIST,
Hyderabad.

Sub: Proposal for Add-on Course-Reg.

Respected sir,

We are going to conduct 10 days Technical Training for II B. Tech students on "Introduction to Auto CAD". We require your approval to go ahead for proceeding and hope to get an opportunity to serve you the best.

With thanks and regards

Dr.S.Murali

HOD

Department of Mechanical Engineering

PRINCIPAL
MIST
INSTITUTE OF TECHNOLOGY AND MANAGEMENT
Bandlaguda, Hyd-500 025.



Date: 30.04.2018

CIRCULAR

Technical Training for II B. Tech students are starting from 1st MAY, 2018 onwards. All HODs and Placements coordinators have to manage the trainings and ensure 95% attendance all through the sessions.

All Mentors need to send the compiled feedback report to Dr.S.Murali, HOD at e3hod.mech@gmail.com daily.

Agenda: 1. Introduction to AUTOCAD.

Design and Development of curriculum for Add on course:

Name of the Faculty : Busireddy Harinath Reddy

Dr.S.Murali

HOD

Department of Mechanical Engineering

MAHAVEER INSTITUTE OF TECHNOLOGY
BANDLAGUDA POST, VYNAPURI,
HYDERABAD - 500 005, TELANGANA
INDIA



Auto CAD SYLLABUS

1: Getting Started with AutoCAD

- Opening and Creating Drawings
- Exploring the AutoCAD interface
- Zooming and Panning

2: Basic Drawing & Editing Commands

- Using the Mouse, Keyboard, and Enter Key to work quickly and efficiently in AutoCAD
- Lines
- Circles
- Rectangles

3: Projects - Creating a Simple Drawing

- Creating Simple Drawings
- Using Object Snap Tracking to extrapolate a projected top view
- Using Modify tools to arrange an office layout

4: Drawing Precision in AutoCAD

- Polar and Ortho Tracking
- Entering Coordinates and Angles
- Object Snaps and Tracking

5: Making Changes in Your Drawing

- Move
- Copy
- Rotate
- Mirror
- Scale
- Using the reference option with the Scale Tool

7: Organizing Your Drawing with Layers

- Layer States
- Properties by Layer
- Layer Tools

8: Advanced Object Types

- Polylines
- Arcs

K. Srinivas

INSTITUTE

Bandlaguda



- Polygons
- Ellipses

9: Advanced Editing Commands

- Trim and Extend
- Fillet and Chamfer
- Polyline Edit and Spline
- Offset and Explode
- Join

10: Inserting Blocks

- The Insert Block Command
- Inserting Blocks with Tool Palettes
- Dynamic Bloes
- Migrating Blocks and other Elements between Drawings with Design Center

11: Text

- The Multiline Text Tool
- The Single Line Text Tool
- Editing Text
- Text in Model Space vs. Paper Space
- The Multileader Tool

12: Hatching

- The Hatch Command
- The Hatch Editor Ribbon Tab
- Saving and Applying Hatches with Tool Palettes

13: Adding Dimensions

- Using Dimensioning Tools
- Dimensioning in a Layout Tab vs. the Model Tab
- Using Dimension Styles
- Editing Dimensions

14: Projects - Annotating Your Drawing

- Dimensioning a Mechanical Drawing

Handwritten signature and notes:
K. Srinivas
18/11/20
Bharatguru.com



Department of Mechanical Engineering Auto CAD Technical Training student attendance list 2018-19

SL.NO.	ROLL NO.	NAME OF THE STUDENT	YEAR
1	17E31A0301	AILNENI HARSHITHI	II
2	17E31A0302	ALLA RAJA	II
3	17E31A0304	BANGARI MOHAN	II
4	17E31A0305	BASANOLA JAYVARDHAN	II
5	17E31A0306	BEJANKI MAHESH REDDY	II
6	17E31A0308	DANDU SANJEEV	II
7	17E31A0309	DEPA JAYANDER REDDY	II
8	17E31A0311	G ABHILASH REDDY	II
9	17E31A0313	GUGGILLA VENKAT SAI	II
10	17E31A0314	GUNNAM VENKATA LAKSHMI AKHILA	II
11	17E31A0316	KANNA MANIKANTA	II
12	17E31A0320	KONDURU PAVAN KUMAR	II
13	17E31A0322	M A GHOUSE	II
14	17E31A0324	MALLETHULA RAHUL	II
15	17E31A0325	MALLISETTI PREM SAI	II
16	17E31A0326	MANGILGI MAHESH	II
17	17E31A0327	MANKENA PRUDHVIRAJ	II
18	17E31A0328	MD ARMAN	II
19	17E31A0333	MOHAMMED RAYEES	II
20	17E31A0339	NALLAMPALLY SRIKANTH REDDY	II
21	18E35A0301	AKULA GIRIDHAR YADAV	II
22	18E35A0302	AYIDALAPALLY SHYAM KUMAR	II

K. Srinivas
22
Principal
Bandlaguda Post, Keshavnagar

Vysapuri, Bandlaguda Post Keshavnri,
Hyderabad-500 005, Telangana INDIA
Tel: 040-64896979,20020773, Fax: 040-24455003
E-mail: principal.mahaveer@gmail.com
Website: www.mist.ac.in

MAHAVEER



Approved by AICTE. Affiliated to JNTU(Hydr)

23	18E35A0303	B CHANDRA SEKHAR	II
24	18E35A0305	BASUDE SAGAR	II
25	18E35A0306	BOLLAM NARESH	II
26	18E35A0307	CH RAJU	II
27	18E35A0308	CHINNABOSKA MAHESH	II
28	18E35A0309	CHINNAPAGU SWETHA	II
29	18E35A0310	DODLA PRATHAP	II
30	18E35A0311	G UMA MAHESHWARI	II
31	18E35A0312	GOKA SAIKRISHNA	II
32	16M31A0322	TELUSRI AJAY	II
33	17M31A0306	SYED MOHAMMED FAIZAN GHORI	II
34	18M35A0308	MOHD FIRASATH ALI	II
35	16E31A0330	PUTTAPAD YADAJAH	II
36	17E35A0317	P TARUN KUMAR	II
37	16E31A0333	R HEMANTH KUMAR	II
38	17E31A0342	P BHARGAV KUMAR	II
39	17E31A0343	PILLI AKHIL BABU	II
40	17E31A0344	POLNENI SAITEJA	II
41	17E31A0346	RUDRARAJU DELPANKAR SARAVANA VARMA	II
42	17E31A0348	SATHYAPRASAD POOJA	II
43	17E31A0352	SHAIKH FAIZAN RAZA	II
44	17E31A0354	SHARAVAN SUTHAR	II
45	17E31A0355	T BUNNY	II
46	17E31A0360	YADAMA SATHISH REDDY	II
47	18E35A0313	GUDA VIKAS	II

Principal
Bandlaguda Post, Hyderabad-500 005

Vysapuri, Bandlaguda Post, Keshavnagar,
Hyderabad 500 026, Telangana, India
Tel: 040-64516979, 20020773; Fax: 040-24450083
E-mail: principal.mahaveer@gmail.com
Website: www.mvst.ac.in

MAHAVEER



Approved by AICTE. Affiliated to JNTU, Hyderabad

48	18E35A0314	JALUKURI RAM MURTHI	II
49	18E35A0315	KANDE VINETHI	II
50	18E35A0317	MADUGULA GOPALA KRISHNA	II
51	18E35A0318	MEGAVATHI MAHIPAL	II
52	18E35A0321	NITIN MAHENDRAKAR	II
53	18E35A0322	NUNAVATHI LINGAM	II
54	18E35A0323	RAPOLU SRIKANTHI	II
55	18E35A0324	THOTLA MAHENDER	II
56	18E35A0325	V PRANEESH	II
57	16621A0316	SYED ABUBAKAR	II
58	17D91A0303	AMPALLY NITHIN KUMAR	II
59	17D91A0304	BAROOR ARVIND REDDY	II
60	17D91A0307	DESANI SANDEEP REDDY	II
61	17D91A0308	DIDDI ROSHAN SAI	II
62	17D91A0309	GOLKONDA NITHISH YADAV	II
63	17D91A0311	GUNTUKA RAMBABU	II
64	17D91A0316	MOHAMMAD IRFAN	II
65	17D91A0320	MULA SATHVIK REDDY	II
66	17D91A0324	SADUVULA DEVI NDER	II
67	17D91A0325	SAMALLA DIVAKAR	II
68	17D91A0330	VODNALA ADITHIYA	II
69	18D95A0301	BEERA PRAVEEN KUMAR	II
70	18D95A0303	GAJULA SANGEETH KUMAR	II
71	18D95A0305	M ASHWINKANTHI	II
72	18D95A0306	MANDAPELLI SRIKANTHI	II
73	18D95A0307	MOOD HATHIRAM	II

Handwritten signature in blue ink.

MS
B...

Vysapuri, Bandlaguda Post, Keshavnagar,
Hyderabad-500 095, Telangana, INDIA
Tel: 040-64556979, 20020773, Fax: 040-24453003
E-mail: principal.mahaveer@gmail.com
Website: www.mist.ac.in

MAHAVEER



Approved by AICTE. Affiliated to JNTU, Hyd.

74	18D95A0310	SARE SRIKANTH	II
75	17E35A0307	K SURESH	II

Keshavnagar
MAHAVEER
INSTITUTE OF
TECHNOLOGY
BANDLAGUDA, HYD-500 095



Technical Training Exam on Auto CAD Software (A.Y-2017-18)

2x10=20 Marks

Answer All the Questions

1. Draw the given 2D model into 3D model by using AutoCad

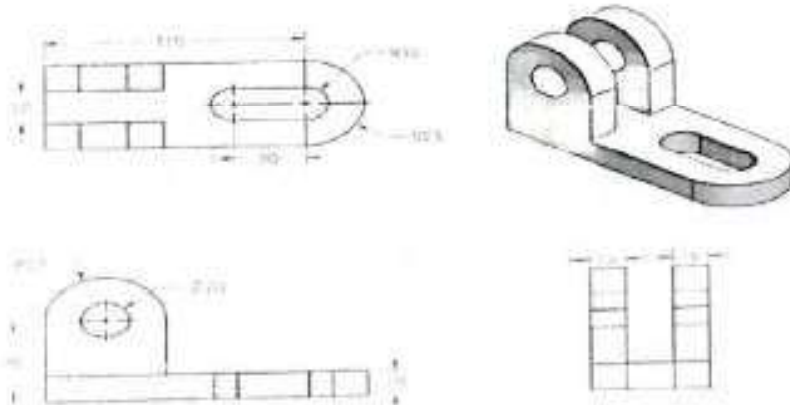

2. Draw the given 2D model into 3D model by using Auto CAD.

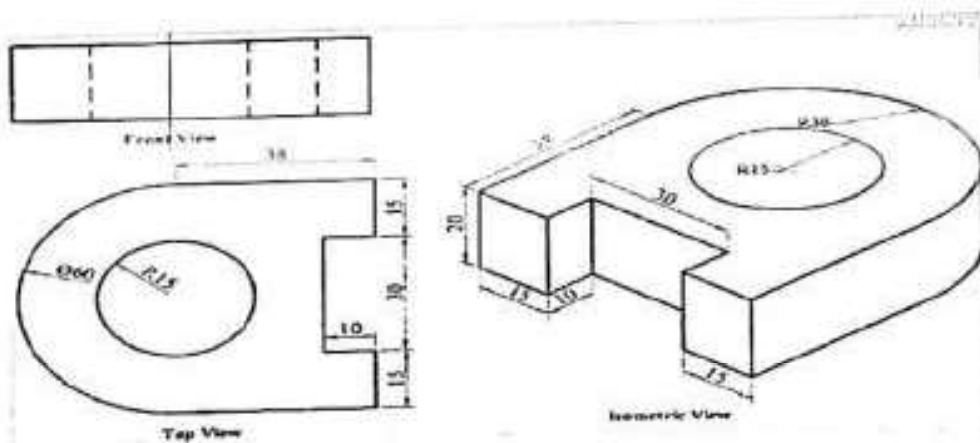

Kishu

Principal
Mahaveer Institute of Technology and Management
Vysapuri, Bandlaguda, Hyderabad-500055



Department of Mechanical Engineering
Auto CAD Technical Training student Marks list 2018-19

SL.NO	Roll No	Name of the student	YEAR	MARKS	PASS/FAIL
1	17E31A0301	AILNENI HARSHITH	II	14	PASS
2	17E31A0302	ALLA RAJA	II	15	PASS
3	17E31A0304	BANGARI MOHAN	II	17	PASS
4	17E31A0305	BASANOLA JAYVARDHAN	II	15	PASS
5	17E31A0306	BEJJANKI MAHESH REDDY	II	16	PASS
6	17E31A0308	DANDU SANJEEV	II	16	PASS
7	17E31A0309	DEPA JAYANDER REDDY	II	16	PASS
8	17E31A0311	G ABHILASH REDDY	II	16	PASS
9	17E31A0313	GUGGILLA VENKAT SAI	II	15	PASS
10	17E31A0314	GUNNAM VENKATA LAKSHMI AKHILA	II	16	PASS
11	17E31A0316	KANNA MANIKANTA	II	12	PASS
12	17E31A0320	KONDURU PAVAN KUMAR	II	15	PASS
13	17E31A0322	M A GHOUSE	II	16	PASS
14	17E31A0324	MALLETHULA RAHUL	II	14	PASS
15	17E31A0325	MALLINATHI PREMAM	II	15	PASS
16	17E31A0326	MANGILGI MAHESH	II	17	PASS
17	17E31A0327	MANKENA PRUDHIVIRAJ	II	15	PASS
18	17E31A0328	MD ARMAN	II	16	PASS
19	17E31A0333	MOHAMMED RAYEES	II	16	PASS
20	17E31A0339	NALLAMPALLY SRIKANTH REDDY	II	16	PASS
21	18E35A0301	AKULA GIRIDHAR YADAV	II	15	PASS
22	18E35A0302	AYIDALAPALLY SHYAM KUMAR	II	15	PASS

Abhishek
Principal
EET
MESTI
Bandlaguda, Hyderabad-500005

Vysapuri, Banitagauda Post, Keshavnagar,
Hyderabad 500 005, Telangana, INDIA
Tel: 040-64596379, 20820773, Fax: 040-24455003
E-mail: principal.mahaveer@gmail.com,
Website: www.mst.ac.in

MAHAVEER



Approved by AICTE, Affiliated to JNTU-Hyd

23	18E35A0303	B CHANDRA SEKHAR	II	16	PASS
24	18E35A0305	BASUDE SAGAR	II	12	PASS
25	18E35A0306	BOLLAM NARESH	II	15	PASS
26	18E35A0307	CH RAJU	II	16	PASS
27	18E35A0308	CHINNABOSKA MAHESH	II	14	PASS
28	18E35A0309	CHINNAPAGU SWETHA	II	15	PASS
29	18E35A0310	DODLA PRATHAP	II	17	PASS
30	18E35A0311	G UMA MAHESHWARI	II	15	PASS
31	18E35A0312	GOKA SAIKRISHNA	II	16	PASS
32	16M31A0322	TELUSRI AJAY	II	16	PASS
33	17M31A0306	SYED MOHAMMED FAIZAN GHORI	II	16	PASS
34	18M35A0308	MOHD FIRASATH ALI	II	16	PASS
35	16E31A0330	PUTTAPAD YADAAH	II	15	PASS
36	17E35A0317	P TARUN KUMAR	II	16	PASS
37	16E31A0333	R HEMANTH KUMAR	II	12	PASS
38	17E31A0342	P BHARGAV KUMAR	II	15	PASS
39	17E31A0343	PILLI AKHIL BABU	II	16	PASS
40	17E31A0344	POLNENI SAITEJA	II	14	PASS
41	17E31A0346	RUDRARAJU DEEPANKAR SARAVANA VARMA	II	15	PASS
42	17E31A0348	SATHYAPRASAD POOJA	II	17	PASS
43	17E31A0352	SHAIKH FAIZAN RAZA	II	15	PASS
44	17E31A0354	SHARAVAN SUTHAR	II	16	PASS
45	17E31A0355	T BUNNY	II	16	PASS
46	17E31A0360	YADAMA SATHISH REDDY	II	16	PASS
47	18E35A0313	GUDA VIKAS	II	15	PASS

Kanika
MAHAVEER
INSTITUTE OF TECHNOLOGY
Banitagauda Post, Keshavnagar,
Hyderabad 500 005, Telangana, INDIA

Vysapuri, Bandlaguda Post Keshavnagar,
Hyderabad-500 005, Telangana INDIA
Tel: 040-64596979, 20020773, Fax: 040-24455003
E-mail: principal.mahaveer@gmail.com
Website: www.mist.ac.in

MAHAVEER



Approved by AICTE. Affiliated to JNTU(H)Hyd

48	18E35A0314	JALUKURI RAM MURTHI	II	16	PASS
49	18E35A0315	KANDE VINEETHI	II	12	PASS
50	18E35A0317	MADUGULA GOPALA KRISHNA	II	15	PASS
51	18E35A0318	MEGAVATH MAHIPAL	II	16	PASS
52	18E35A0321	NITIN MAHENDRAKAR	II	14	PASS
53	18E35A0322	NUNAVATH LINGAM	II	15	PASS
54	18E35A0323	RAPOLU SRIKANTH	II	17	PASS
55	18E35A0324	THOTLA MAHENDER	II	15	PASS
56	18E35A0325	V PRANEESH	II	16	PASS
57	16621A0316	SYED ABUBAKAR	II	16	PASS
58	17D91A0303	AMPALLY NITHIN KUMAR	II	15	PASS
59	17D91A0304	BAROOR ARVIND REDDY	II	16	PASS
60	17D91A0307	DESANI SANDEEP REDDY	II	14	PASS
61	17D91A0308	DIDDI ROSHAN SAI	II	15	PASS
62	17D91A0309	GOLKONDA NITHISH YADAV	II	17	PASS
63	17D91A0311	GUNTUKA RAMBABU	II	15	PASS
64	17D91A0316	MOHAMMAD IRFAN	II	10	PASS
65	17D91A0320	MULA SATHVIK REDDY	II	16	PASS
66	17D91A0324	SADUVULA DEVENDER	II	16	PASS
67	17D91A0325	SAMALLA DIVAKAR	II	15	PASS
68	17D91A0330	VODNALA ADITHYA	II	16	PASS
69	18D95A0301	BEERA PRAVEEN KUMAR	II	12	PASS
70	18D95A0303	GAJULA SANGEETH KUMAR	II	15	PASS
71	18D95A0305	M ASHWINKANTH	II	16	PASS

MAHAVEER
INSTITUTE OF TECHNOLOGY
Bandlaguda, Hyderabad-500 005

Vysapuri, Bandlaguda Post Keshavnagar,
Hyderabad-500 005, Telangana (INDIA)
Tel: 040-64596379,20029773, Fax: 040-24455093
E-mail: principal.mahaveer@gmail.com
Website: www.mst.ac.in

MAHAVEER



Approved by AICTE, Affiliated to JNTUH, Hyd

72	18D95A0306	MANDAPELLI SRIKANTH	II	14	PASS
73	18D95A0307	MOOD HATHIRAM	II	15	PASS
74	18D95A0310	SARE SRIKANTH	II	17	PASS
75	17E35A0307	K SURESH	II	15	PASS

Principal
MST
18/07/2018
Bandlaguda, Hyd-500 005



Auto CAD COURSE
Summary

Department of Mechanical Engineering

- Use AutoCAD for daily working process.
- Navigate throughout AutoCAD using major navigating tools.
- Understand the concept and techniques to draw.
- Create multiple designs using several of tools.
- Create layers to control the objects' visibility.
- Explain drawing using annotations.
- Plot or print the drawing by scale.
- To use constraint for certain design.

Copy to :

1. Department of Notice Board
2. Principal for Information
3. Committee Members(Academic)

MAHAVEER
Principal
Date: 20/05/2023
Page: 1/1

Vysapuri, Bandlaguda Post Keshavnagar
Hyderabad-500 005, Telangana INDIA
Tel: 040-64596979, 20020773, Fax: 040-24455003
E-mail: principal.mahaveer@gmail.com
Website: www.mist.ac.in

MAHAVEER



Approved by AICTE, Affiliated to JNTU/Hyd

CERTIFICATE OF COURSE COMPLETION

This certificate is presented to V. Praneesh of
MIST, who has successfully completed technical training course on
"Auto CAD" held from 01-05-2018 to 11-05-2018 and found the
student performance to be excellent.

(Faint blue stamp)

PRINCIPAL
MAHAVEER
INSTITUTE OF SCIENCE & TECHNOLOGY
Bandlaguda, Hyd-500 005.



ESTD : 2001

(Handwritten signature)
D. S. Murali
HOD

Department of Mechanical Engineering

Mysapuri, Banatogutta Post Graduate Centre
Hyderabad-500 085, Telangana 500085
T: 01-64580779, 20020775, Fax: 01-6455003
E: mysapuri@rediffmail.com, mysapuri@rediffmail.com
Website: www.mysapuri.ac.in

MACHAVER

APPROVED BY AICTE. AFFILIATED TO JNTU HYD.



DEPARTMENT OF MECHANICAL ENGINEERING

List of students enrolled in Auto CAD (2018-2019)

S.No	Roll No	Name of the student	15/18	2/c	18/2	5/18	4/18	1/18	7/18	8/18	10/18	11/18	12/18
1	17E31A0301	ALNANI HARSHITH	P	P	P	P	P	P	P	P	P	P	P
2	17E31A0302	ALLA RAJA	P	P	P	P	P	P	P	P	P	P	P
3	17E31A0304	BANGARI MOHAN	P	P	P	P	P	P	P	P	P	P	P
4	17E31A0305	BASANOLA JAYVARDHAN	P	P	P	P	P	P	P	P	P	P	P
5	17E31A0306	BEJANKI MAHESH REDDY	P	P	P	P	P	P	P	P	P	P	P
6	17E31A0308	DANDU SANJEEV	P	P	P	P	P	P	P	P	P	P	P
7	17E31A0309	DEPA JAYANDER REDDY	P	P	P	P	P	P	P	P	P	P	P
8	17E31A0311	GABRILASHI REDDY	P	P	P	P	P	P	P	P	P	P	P
9	17E31A0313	GUGGILLA VENKAT SAI	P	P	P	P	P	P	P	P	P	P	P

Kalyani

P. S. SURESH
27/11/2018
09:20:00 AM



DEPARTMENT OF MECHANICAL ENGINEERING

List of students enrolled in Auto CAD (2018-2019)

41	17E31A0346	RUDRARAJU DEEPANKAR SARAVANA VARMA	P	P	P	P	P	P	P	P	P	P	P	P	P	P	P	P
42	17E31A0348	SATHYAPRASAD POOJA	P	P	P	P	P	P	P	P	P	P	P	P	P	P	P	P
43	17E31A0352	SHAIKH FAIZAN RAZA	P	P	P	P	P	P	P	P	P	P	P	P	P	P	P	P
44	17E31A0354	SHARAVAN SETHI	P	P	P	P	P	P	P	P	P	P	P	P	P	P	P	P
45	17E31A0355	T BUNNY	P	P	P	P	P	P	P	P	P	P	P	P	P	P	P	P
46	17E31A0360	YADAMA SATHISH REDDY	P	P	P	P	P	P	P	P	P	P	P	P	P	P	P	P
47	18E35A0313	GUDA VIKAS	P	P	P	P	P	P	P	P	P	P	P	P	P	P	P	P
48	18E35A0314	JALUKURAM MURTHI	P	P	P	P	P	P	P	P	P	P	P	P	P	P	P	P
49	18E35A0315	KANDEVINEETHI	P	P	P	P	P	P	P	P	P	P	P	P	P	P	P	P
50	18E35A0317	MADUGULA GOPALA KRISHNA	P	P	P	P	P	P	P	P	P	P	P	P	P	P	P	P
51	18E35A0318	MEGAVATHI MAHPAL	P	P	P	P	P	P	P	P	P	P	P	P	P	P	P	P

Handwritten signature

Handwritten text

Nymbari, Shri Jagadgurur Prasad Math, Bangalore
 44th Cross, 5th Block, 5th Stage, 5th Floor,
 Tel: 040-84596379, 200 20 775, Fax: 040-84596379
 E-mail: principal@mahaveer.ac.in
 Website: www.mahaveer.ac.in

MAHAVEER
 APPROVED BY AICTE. APPROVED BY JNTU

DEPARTMENT OF MECHANICAL ENGINEERING

64	17D91A0316	MOHAMMAD IRFAN	P	P	P	P	P	P	P	P	P	P	P	P	P	P	P	P	P
65	17D91A0320	MULA SATHVIA REDDY	P	P	P	P	P	P	P	P	P	P	P	P	P	P	P	P	P
66	17D91A0324	SADUVULA DEVENDER	P	P	P	P	P	P	P	P	P	P	P	P	P	P	P	P	P
67	17D91A0325	SAMAILA DIVAKAR	P	P	P	P	P	P	P	P	P	P	P	P	P	P	P	P	P
68	17D91A0330	VODNALA ADITHYA BEERA	P	P	P	P	P	P	P	P	P	P	P	P	P	P	P	P	P
69	18D95A0301	PRAVEEN KUMAR	P	P	P	P	P	P	P	P	P	P	P	P	P	P	P	P	P
70	18D95A0303	GAJULA SANGEETHA KUMAR	P	P	P	P	P	P	P	P	P	P	P	P	P	P	P	P	P
71	18D95A0305	M ASHWINKANTH	P	P	P	P	P	P	P	P	P	P	P	P	P	P	P	P	P
72	18D95A0306	MANDAPELJI SRIKANTH	P	P	P	P	P	P	P	P	P	P	P	P	P	P	P	P	P
73	18D95A0307	MOOD BATHIRAM	P	P	P	P	P	P	P	P	P	P	P	P	P	P	P	P	P
74	18D95A0310	SARE SRIKANTH	P	P	P	P	P	P	P	P	P	P	P	P	P	P	P	P	P

Handwritten signature and date:
 K. S. S. S.
 12/12/2018

VysaDarl, Banthiguda Post, Mahaveer
Hyderabad-500 006, Telangana 141014
T: 040-64556979, 21020773, Fax: 040-64550003
E-mail: principal.mahaveer@mahaveer.edu.in
Website: www.mahaveer.edu.in



MAHAVEER

Approved by AICTE. Affiliated to JNTU-Hydr.

DEPARTMENT OF MECHANICAL ENGINEERING

List of students enrolled in Auto CAD (2018-2019)

75	17E35A0307	K SURESH	P	P	P	P	P	P	P	P	P	P	P	P	P	P	P	P	P
----	------------	----------	---	---	---	---	---	---	---	---	---	---	---	---	---	---	---	---	---

K. Suresh

PRINCIPAL
N. V. VEER
MST: 73-1-14500 * 11111 * 1111
Banthiguda, Hyd-500 006

About the College

As an Institute committed in quality education, MIST aims at providing learning with a Technology-edge. It endeavors to provide consistent training to its students to help them evolve as competent professionals in the highly competitive world. Right from its inception in 2001, it has been tuning itself to meet this objective. A new civilization is emerging in our lives. This civilization brings with it a new way of working. Millions are already tuning their lives to the rhythms of tomorrow.

About the Mechanical Dept.

The Mechanical engineering is one of the core engineering departments, which has potential to accommodate all efficient engineers. The Mechanical engineers serve all other branches of engineering directly or indirectly. The Mechanical engineers can find their place in Automobile engineering sector, Steel Plants, Power plants, Software industries, Manufacturing industries, Design industries, Military, Naval and Air force, Defense research organizations, Material research organizations etc.

About the Workshop

CATIA delivers the unique ability not only to model any product, but to do so in the context of its real-life behavior: design in the age of experience. CATIA (Computer-Aided Three dimensional Interactive Application) software is a complete multi-platform solution for computer-aided design, manufacturing, engineering, 3D and PLM. Marketed by manufacturer Dassault Systemes, the software is ideal for creating solids, surfaces, assemblies, drawings, fabrication and analysis. However, CATIA offers more advanced functionality for surfaces and modules for different industries.

Organizing committee

CHIEF PATRON

Smt. S. Jayalakshmi Reddy

Chairman

Sri. S. Surendar Reddy

Secretary

Sri S. Dhanunjay Reddy

Joint Secretary

DIRECTOR

Dr. H. S. N. Murthy

PATRON

Dr K.S.S.N Reddy, Principal

CONVENER

Dr.S.Murall

Professor, Dept. Of Mechanical

PROGRAM COORDINATORS

Mr.P.PraveenKumarReddy

Duration

01/05/2018-11/5/2018



MAHAVEER
INSTITUTE OF SCIENCE & TECHNOLOGY

Approved by AICTE, Affiliation: 201711, Hyderabad,
Warakuru, Bandlaguda, Post: Kityraopeta, Hyderabad-500005.



Two week
Certification Course
on

Introduction to CATIA

Organized by

Department of Mechanical
Engineering

Vysapuri, Bandlaguda Post Keshavnigri,
Hyderabad-500 005, Telangana INDIA
Tel: 040-64596379, 2002773, Fax: 040-24455003
E-mail: principal.mahaveer@gmail.com,
Website: www.mist.ac.in,

MAHAVEER



Approved by AICTE - Affiliated to JNTU(Hy)

Date: 28-04-2018

To
The Principal
MIST,
Hyderabad.

Sub: Proposal for Add-on Course-Reg.

Respected sir,

We are going to conduct 10 days Technical Training for II B. Tech students on "Introduction to Catia". We require your approval to go head for proceeding and hope to get an opportunity to serve you the best.

With thanks and regards

Dr.S.Murali

HOD

Department of Mechanical Engineering

Mahaveer
Institute of Technology
Bandlaguda, Hyderabad-500 005.

Vysapuri, Banflaguda Post Keshavnagar,
Hyderabad-500 005, Telangana INDIA
Tel: 040-64596979,20020773. Fax: 040-24455003
E-mail: principal.mahaveer@gmail.com
Website: www.mst.ac.in

MAHAVEER



Approved by AICTE. Affiliated to JNTUHYD

Date: 30.04.2018

CIRCULAR

Technical Training for III B. Tech students are starting from 1st MAY, 2018 onwards. All HODs and Placements coordinators have to manage the trainings and ensure 95% attendance all through the sessions.

All Mentors need to send the compiled feedback report to Dr.S.Murali, HOD.

Agenda:

1. Introduction to CATIA.

Design and Development of curriculum for Add on course:

Name of the Faculty : P Praveen Kumar Reddy

Dr.S.Murali

HOD

Department of Mechanical Engineering

Principal
MAHAVEER
INSTITUTE OF TECHNOLOGY
Banflaguda, Hyderabad-500 005.



CATIA SYLLABUS

Total Hours: 48

I. Introduction:

- Modulus
- Features (powerful Tools
- Parametric modeling
- Feature based approach
- Parent – child Relationship)
- Associative and Model Centric
- b) Information about Interface
- Tools; Menu, etc.

II. Sketcher:

- Getting Started
- Interface
- Sketch tools
- Profiles
- Operations
- Constraints
- Sketcher preferences
- References

III. Part Features:

- Sketch Based Features
- Pad
- Pocket
- Thru
- Shaft
- Groove
- Hole

K. S. S. S.
PRINCIPAL
MAHAVEER
INSTITUTE OF SCIENCE & TECHNOLOGY
Bandlaguda, Hyd-500 005.

- Threaded Hole
- Rib
- Slot
- Multi section solid

IV. Dress-up Features

- Fillet
- Chamfer
- Draft
- Shell
- Thickness
- Thread/Tap

V. Reference Element

Point

Line

Plane

VI. Assembly Modeling:

- Assembly Constraints
- Manipulation
- Defining a multi & fast multi-instantiation
- Analyzing an assembly

VII. Drafting:

- Sheets & Views
- View modification
- Generating dimensions
- Bill of material
- Dimensions
- Annotations
- Dress up Elements
- Properties
- Exporting and Importing files



Department of Mechanical Engineering
CATIA Technical Training student attendance list 2018-19

S.NO.	ROLL NO.	NAME OF THE STUDENT	YEAR
1	16E31A0301	B PRAVEEN KUMAR	III
2	16E31A0305	G RAMAKRISHNA	III
3	16E31A0306	G VENU GOPAL	III
4	16E31A0307	GADDI SUDHAMSHU	III
5	16E31A0308	GAJELLI VAMSHI KRISHNA	III
6	16E31A0313	KOVA SAIKUMAR	III
7	16E31A0314	LUNAVATH GANESH	III
8	16E31A0318	MOHAMMED MUBEEN QURESHI	III
9	16E31A0319	MOHD ABDUL SAMEER	III
10	16E31A0320	MOHD ABDUL AHTEHAM UL HASNAIN	III
11	16E31A0323	N SRIKANTH REDDY	III
12	16E31A0324	NALLA TEJASWI	III
13	16E31A0325	PANUGANTI SAI KIRAN GOUD	III
14	16E31A0326	PATLOLLA PRASHANTH REDDY	III
15	16E31A0327	PONNURU UPENDRA	III
16	16E31A0328	PULJALA ANIL	III
17	16E31A0329	PUNEET RAJ CHAVAN	III
18	16E31A0330	PUTTAPAD YADAJAH	III
19	16E31A0331	R VAYU PUTHRA	III
20	16E31A0332	RAMAKRISHNA LAKMALA	III
21	16E31A0333	RAVULA HEMANTH KUMAR	III
22	16E31A0334	SHAIK MUJAFER	III
23	16E31A0336	SYED ZAINUDDIN	III

(Signature)
PRINCIPAL
MAHAVEER
INSTITUTE OF SCIENCE & TECHNOLOGY
BANDLAGUDA, HYD-500 005

Vysapuri, Bandlaguda Post Keshavnagar,
Hyderabad-500 005, Telangana INDIA
Tel: 040-64596979, 20020773, Fax: 040-24455003
E-mail: principal.mahaveer@gmail.com,
Website: www.mist.ac.in.

MAHAVEER



Approved by AICTE, Affiliated to JNTU, Hyd.

24	16E31A0337	TEJAVATH SRIKANTH	III
25	16E31A0338	THONGAR NARAYANA	III
26	16E31A0339	THOTA PAVAN KUMAR	III
27	16E31A0340	YELTI SREYA	III
28	16E31A0342	ABU SUFYAN MALIK	III
29	16E31A0343	AKASH SABHINANI	III
30	16E31A0344	AMERINANI ANIL KUMAR	III
31	16E31A0345	ARAKALA SHIVA	III
32	16E31A0346	BAGI VDENDER REDDY	III
33	16E31A0350	DEVI SHRI PRASAD PATANGI	III
34	16E31A0351	EDAM SAIRAM	III
35	16E31A0352	ERLA MAHENDRA KUMAR	III
36	16E31A0353	ISHRATH UNNISA BEGUM	III
37	16E31A0354	KATPALLY SRENU REDDY	III
38	16E31A0356	KOLLA RAJASHEKAR REDDY	III
39	16E31A0358	KOMMIDI SHRAVAN REDDY	III
40	16E31A0360	KOTHALAPURAM ANUSHA	III
41	16E31A0361	KUDUTHALA AKHIL	III
42	16E31A0362	MADHAGONE AKHIL TEJA	III
43	16E31A0364	MOHAMMED LUQMAN ZAKI	III
44	16E31A0365	MOHAMMED RIZWANUDDIN	III
45	16E31A0368	PATHAKOTI JAGADISH	III
46	16E31A0369	PULUGARI JAGADEESHWAR REDDY	III
47	16E31A0370	PYATA PRASHANTH KUMAR	III
48	16E31A0371	SHAIK SAMEER	III
49	16E31A0374	SYED OMAIR AHMED	III

12/5/2017
Principal
MAHAVEER
INSTITUTE OF MANAGEMENT & TECHNOLOGY
Bandlaguda Post, Hyderabad-500 005.

Vysepuri, Bandlaguda Post Keshavgiri,
Hyderabad-500 005, Telangana INDIA
Tel: 040-64696979, 20020773, Fax: 040-24455003
E-mail: principal.mahaveer@gmail.com,
Website: www.misl.ac.in,

MAHAVEER



Approved by AICTE, Affiliated to JNTUH, Hyd.

76	17E35A0321	SYED SOHAIL AHMED	III
77	17E35A0322	VADLA SRIKANTH	III
78	15E31A0335	MOHD ABDUL HASEEB	III

K. S. S. S.
Principal
MAHAVEER
Vyssepur, Bandlaguda Post Keshavgiri,
Hyderabad-500 005, Telangana INDIA



Technical Training Exam on Catia Software (A.Y-2018-19)

2x10=20 Marks

Answer All the Questions

1. Draw the given figure by using Catia software.

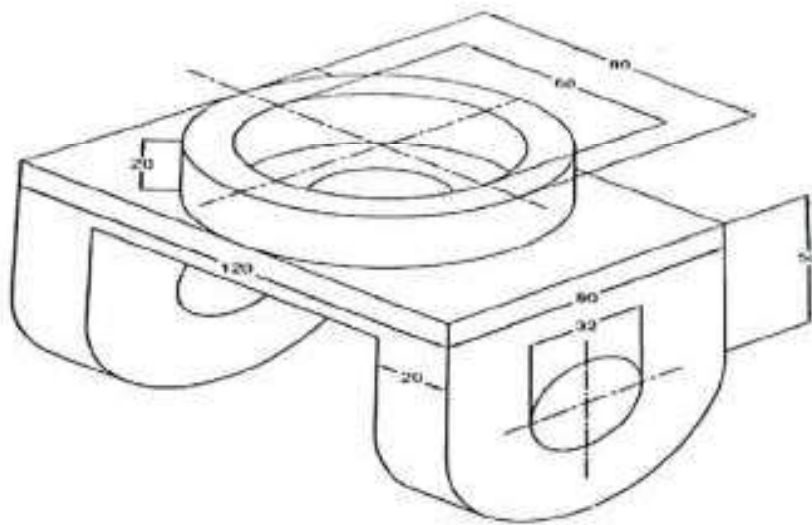

2. Draw the given 2D model into 3D model by using Catia.

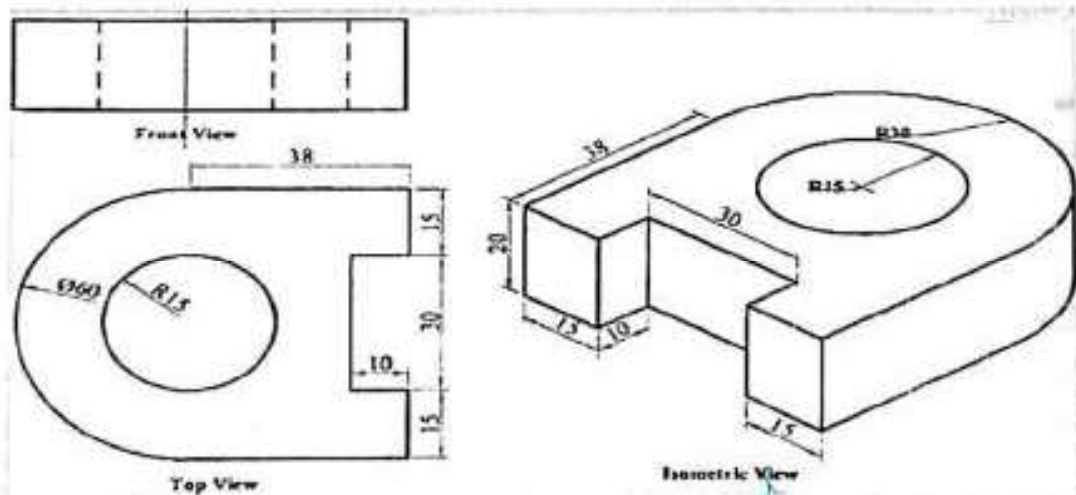

Isometric View
M. K. K. K.
M. K. K. K.
M. K. K. K.



Department of Mechanical Engineering
CATIA Technical Training student Marks list 2018-19

S.NO	Roll No	Name of the student	YEAR	MARKS	PASS/FAIL
1	16E31A0301	B PRAVEEN KUMAR	III	14	PASS
2	16E31A0305	G RAMAKRISHNA	III	15	PASS
3	16E31A0306	G VENU GOPAL	III	17	PASS
4	16E31A0307	GADDI SUDHAMSHU	III	15	PASS
5	16E31A0308	GAJELLI VAMSHI KRISHNA	III	16	PASS
6	16E31A0313	KOVA SAIKUMAR	III	16	PASS
7	16E31A0314	LUNAVATH GANESH	III	15	PASS
8	16E31A0318	MOHAMMED MUBEEN QURESHI	III	14	PASS
9	16E31A0319	MOHD ABDUL SAMEER	III	15	PASS
10	16E31A0320	MOHD ABDUL AHTESHAM UL HASNAIN	III	17	PASS
11	16E31A0323	N SRIKANTH REDDY	III	15	PASS
12	16E31A0324	NALLA TEJASWI	III	16	PASS
13	16E31A0325	PANUGANTI SAI KIRAN GOUD	III	15	PASS
14	16E31A0326	PATLOLLA PRASHANTH REDDY	III	15	PASS
15	16E31A0327	PONNURU UPENDRA	III	16	PASS
16	16E31A0328	PULJALA ANIL	III	14	FAIL
17	16E31A0329	PUNEET RAJ CHAVAN	III	15	PASS
18	16E31A0330	PUTTAPAD YADALAH	III	17	PASS
19	16E31A0331	R VAYU PUTHRA	III	15	PASS
20	16E31A0332	RAMAKRISHNA LAKMALA	III	16	PASS
21	16E31A0333	RAVULA HEMANTH KUMAR	III	16	PASS
22	16E31A0334	SHAIK MUJAFER	III	15	PASS
23	16E31A0336	SYED ZAINUDDIN ABED	III	16	PASS

K. S. Reddy
Principal
MAHAVEER
Institute of Technology
Bandlaguda, Hyderabad-500085

Vysapur, Bandlaguda Post Keshavnagar,
Hyderabad-500 005, Telangana INDIA
Tel: 040-64396979, 20928771, Fax: 040-24455003
E-mail: principal.mahaveer@gmail.com
Website: www.mst.ac.in

MAHAVEER



Approved by AICTE - Affiliated to JNTUH Hyd

24	16E31A0337	TEJAVATHI SRIKANTHI	III	14	PASS
25	16E31A0338	THONGAR NARAYANA	III	15	PASS
26	16E31A0339	THOTA PAVAN KUMAR	III	15	PASS
27	16E31A0340	YELTI SREYA	III	16	PASS
28	16E31A0342	ABU SUFYAN MALIK	III		PASS
29	16E31A0343	AKASH SABIHANI	III	16	PASS
30	16E31A0344	AMERINANI ANIL KUMAR	III	15	PASS
31	16E31A0345	ARAKALA SHIVA	III	14	PASS
32	16E31A0346	BAGI VIJENDER REDDY	III	18	PASS
33	16E31A0350	DEVI SHRI PRASAD PATANGI	III	15	PASS
34	16E31A0351	EDAM SAIRAM	III	16	PASS
35	16E31A0352	ERLA MAHENDRA KUMAR	III	16	PASS
36	16E31A0353	ISHRATHI UNNISA BEGUM	III	15	PASS
37	16E31A0354	KATPALLY SRENU REDDY	III	16	PASS
38	16E31A0356	KOLLA RAJASHEKAR REDDY	III	15	PASS
39	16E31A0358	KOMMIDI SHRAVAN REDDY	III	14	PASS
40	16E31A0360	KOTHALAPURAM ANUSHA	III	18	PASS
41	16E31A0361	KUDUTHALA AKHIL	III	15	PASS
42	16E31A0362	MADHAGONE AKHIL TEJA	III	16	PASS
43	16E31A0364	MOHAMMED LUQMAN ZAKI	III	16	PASS
44	16E31A0365	MOHAMMED RIZWANUDDIN	III	15	PASS
45	16E31A0368	PATHAKOTI JAGADISH	III	16	PASS
46	16E31A0369	PULUGARI JAGADEESHWAR REDDY	III	14	PASS
47	16E31A0370	PYATA PRASHANTHI KUMAR	III	18	PASS
48	16E31A0371	SHAIK SAMEER	III	15	PASS
49	16E31A0374	SYED OMAIR AHMED	III	16	PASS

K. S. S. S.

Principal
Mahaveer Institute of Technology
Bandlaguda, Hyderabad-500 005

Vysapuri, Bandlaguda Post Keshavnagar,
Hyderabad 500 005, Telangana INDIA
Tel: 040-6409979, 20020773, Fax: 040-24455093
E-mail: principal.mahaveer@gmail.com
Website: www.mst.ac.in

MAHAVEER



Approved by AICTE. Affiliated to JNTUHYD

50	16E31A0376	TUMMALA PALLY VINAY REDDY	III	15	PASS
51	16E31A0377	V SHIVA KUMAR REDDY	III	16	PASS
52	16E31A0378	VALGOTE NIKHIL KUMAR	III	15	PASS
53	16E31A0379	YATA VISHNUVARDHAN REDDY	III	16	PASS
54	15E31A0324	K SAI TEJA	III	15	PASS
55	15E31A0323	K RAJESH	III	14	PASS
56	15E31A0326	MD ABUBAKAR SIDDIQ	III	18	PASS
57	17E35A0301	ALAKANTI SWARAJYAM	III	15	PASS
58	17E35A0302	B MAHESH	III	16	PASS
59	17E35A0303	BHOOMENI VENKATA SAI	III	15	PASS
60	17E35A0304	BODIGAM SRINATH	III	16	PASS
61	17E35A0305	GOMASA HARSHAVARDHAN	III	15	PASS
62	17E35A0306	JAMPALA SAIKUMAR	III	16	PASS
63	17E35A0307	KAIRAMKONDA SURESH	III	15	PASS
64	17E35A0308	KARISHA SURESH	III	14	PASS
65	17E35A0309	KONKATA KARTHIK	III	18	PASS
66	17E35A0310	KUMMARA PAVANKUMAR	III	15	PASS
67	17E35A0311	MAHESH	III	16	PASS
68	17E35A0312	MD ASIF	III	16	PASS
69	17E35A0313	MOGUNURI NARENDRA	III	15	PASS
70	17E35A0314	MOHAMMED ABDUL RAQEEB	III	16	PASS
71	17E35A0316	PAISHETTY NAGA VAMSHI	III	15	PASS
72	17E35A0317	PANTHULU TARUN KUMAR	III	14	PASS
73	17E35A0318	PORISHETTI BHANUCHANDER	III	18	PASS
74	17E35A0319	SAMSARBANDA RAGHAVENDRA REDDY	III	15	PASS
75	17E35A0320	SHAIK MINHAJ UDDIN	III	16	PASS

Khanh
PRINCIPAL
MAHAVEER
INSTITUTE OF SCIENCE & TECHNOLOGY
bandlaguda, Hyderabad

Vysapuri, Bandlaguda Post Keshavnagar,
Hyderabad-500 005, Telangana INDIA
Tel: 040-64596979, 20020773, Fax: 040-24455003
E-mail: principal.mahaveer@gmail.com
Website: www.mahaveer.ac.in

MAHAVEER



Approved by AICTE, Affiliated to JNTUH Hyd

76	17E35A0321	SYED SOHAIL AHMED	III	16	PASS
77	17E35A0322	VADLA SRIKANTH	III	15	PASS
78	15E31A0335	MOHD ABDUL HASEEB	III	16	PASS

Handwritten signature
PRINCIPAL
MAHAVEER



CATIA COURSE

Summary

- In this course, you will learn how to utilize the core functionality enhancements in Catia.
- First, you will become familiar with using and customizing the new ribbon interface in Catia.
- The new measure and sectioning interfaces will also be examined. Next, you will become familiar with the Sketcher workflow and reference enhancements.
- Part modeling enhancements to features such as Extrude, Corner Chamfer, Sweeps, Blends, and Datum Curves will then be examined.
- You will also learn about new and enhanced Assembly capabilities, such as selecting multiple components, the new relationship constraints, and enhancements for dragging components.
- Then, you will examine the new Table and Balloon functionality for 2-D drawings, and review various detailing enhancements.
- At the end of each module, you will complete a set of review questions to reinforce critical topics from that module. At the end of the course, you will complete a course assessment in Catia intended to evaluate your understanding of the course as a whole.

Copy to :

1. Department of Notice Board
2. Principal for Information
3. Committee Members (Academic)

Principal
PRINCIPAL
MAHAVEER
INSTITUTE OF SCIENCE & TECHNOLOGY
Bandlaguda, HYD-500 005

Vysapuri, Bandlaguda Post Neshavari,
Hyderabad-500 005, Telangana INDIA
Tel: 040-64096979/20020773, Fax: 040-24495003
E-mail: principal.mshaveer@gmail.com
Website: www.mist.ac.in

MAHAVEER



Approved by AICTE. Affiliated to JNTUHYD

CERTIFICATE OF COURSE COMPLETION

This certificate is presented to K. RAJESH of
MIST, who has successfully completed technical training course on
"CATIA" held from 01-05-2018 to 11-05-2018 and found the
student performance to be excellent.



ESTD : 2001

D. S. Murthy

HOD

Department of Mechanical Engineering

K. Rajesh
Principal
MAHAVEER
INSTITUTE OF SCIENCE & TECHNOLOGY
Bandlaguda, Hyd-500 005.

DEPARTMENT OF MECHANICAL ENGINEERING

List of students enrolled in CATIA (2018-2019)

S.No	Roll No	Date	Name of the student	P	P	P	P	P	P	P	P	P	P	P	P	P	P	P	P	P
1	16E31A0301		B.PRAVESH KUMAR	P	P	P	P	P	P	P	P	P	P	P	P	P	P	P	P	P
2	16E31A0305		GRAMAKRISHNA	P	P	P	P	P	P	P	P	P	P	P	P	P	P	P	P	P
3	16E31A0306		GVENU GOPAL	P	P	P	P	P	P	P	P	P	P	P	P	P	P	P	P	P
4	16E31A0307		GADDI SUDHAKSHI	P	P	P	P	P	P	P	P	P	P	P	P	P	P	P	P	P
5	16E31A0308		GAJELLI VAMSHI KRISHNA	P	P	P	P	P	P	P	P	P	P	P	P	P	P	P	P	P
6	16E31A0313		KOYA SAIKUMAR	P	P	P	P	P	P	P	P	P	P	P	P	P	P	P	P	P
7	16E31A0314		LUNAVATHI GANESH	P	P	P	P	P	P	P	P	P	P	P	P	P	P	P	P	P
8	16E31A0318		MOHAMMED MUBIN QURESHI	P	P	P	P	P	P	P	P	P	P	P	P	P	P	P	P	P
9	16E31A0319		MOHD ABDUL SAMIR	P	P	P	P	P	P	P	P	P	P	P	P	P	P	P	P	P
10	16E31A0320		MOHD ABDUL AHESHAM UL HASNAIN	P	P	P	P	P	P	P	P	P	P	P	P	P	P	P	P	P
11	16E31A0323		N.SRIKANTH REDDY	P	P	P	P	P	P	P	P	P	P	P	P	P	P	P	P	P

Handwritten signature and stamp:
 MAHARAJA UNIVERSITY OF EDUCATION
 MAHARAJA UNIVERSITY OF EDUCATION



MAHAVEER
INSTITUTE OF SCIENCE & TECHNOLOGY

Approved by AICTE, Affiliated to JNTU, Hyderabad.
Vasireddy, Ramisripudi, Post: Kesthigudi, Hyderabad-500005.

ESTD. 2001

Organising committee

CHIEF PATRON

Smt. S. Jayalakshmi Reddy

Chairman

Sri. S. Surendar Reddy

Secretary

Sri S. Dhanunjay Reddy

Joint Secretary

DIRECTOR

Dr. H. S. N. Murthy

PATRON

Dr K.S.S.N Reddy, Principal

CONVENER

Dr.S.Murali

Professor, Dept. Of Mechanical

PROGRAM COORDINATORS

Mr. B.Venkateswar Reddy

Conducted On

2/5/2018- 14/5/2018

About the College

As an Institute committed in quality education, MIST aims at providing learning with a Technology-edge. It endeavors to provide consistent training to its students to help them evolve as competent professionals in the highly competitive world. Right from its inception in 2001, it has been tuning itself to meet this objective. A new civilization is emerging in our lives. This civilization belongs with a new way of working. Millions are already tuning their lives to the rhythms of tomorrow.

About the Mechanical Dept.

The Mechanical engineering is one of the core engineering departments, which has potential to accommodate all efficient engineers. The Mechanical engineers serve all other branches of engineering directly or indirectly. The Mechanical engineers can find their place in Automobile engineering sector, Steel Plants, Power plants, Software industries, Manufacturing industries, Design industries, Military, Naval and Air force, Defense research organizations, Material research organizations etc.

About the Workshop

The course builds from the big ideas in finite element analysis and computational fluid dynamics to ANSYS case studies that progress from real world applications and examples. ANSYS is the flagship engineering software solution that uses finite element analysis (FEA), which is a numerical and computational method used to solve the real engineering problems related to physics, structural analysis, heat transfer, fluid flow, mass transport, and electromagnetic potential field. To solve the problem, it subdivides a large problem into smaller, simpler parts that are called finite elements and solve the problem by minimizing an associated error function.



**Two week
Certification Course
on**

ANSYS

Organized by

**Department of Mechanical
Engineering**

Vysapuri, Bandlaguda Post Keshavnagar,
Hyderabad 500 001, Telangana INDIA
Tel: 040-84556979, 20020773, Fax: 040-24456083
E-mail: principalmahaveer@gmail.com
Website: www.mist.ac.in

MAHAVEER



Approved by AICTE Affiliated to JNTUHHyd

Date: 30-04-2018

To
The Principal
MIST,
Hyderabad,

Sub: Proposal for Add-on Course-Reg.

Respected sir,

We are going to conduct 10 days Technical Training for IV B. Tech students on "Introduction to ANSYS". We require your approval to go ahead for proceeding and hope to get an opportunity to serve you the best.

With thanks and regards

PRINCIPAL
MAHAVEER
INSTITUTE OF SCIENCE & TECHNOLOGY
Bandlaguda, Hyderabad 500001



Dr.S.Murali

HOD

Department of Mechanical Engineering



Date: 01.05.2018

CIRCULAR

Technical Training for IV B. Tech students are starting from 2nd MAY, 2018 onwards. All HODs and Placements coordinators have to manage the trainings and ensure 95% attendance all through the sessions.

All Mentors need to send the compiled feedback report to Dr.S.Murali., HOD at e3hod.mech@gmail.com daily.

Agenda: 1. Introduction to ANSYS.

Design and Development of curriculum for Add on course:

Name of the Faculty : B.Venkateswar Reddy

PRINCIPAL
MAHAVEER
INSTITUTE OF TECHNOLOGY
BANDLAGUDA, HYDERABAD

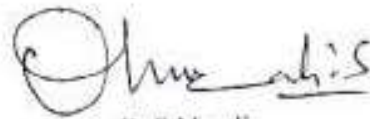

Dr.S.Murali

HOD

Department of Mechanical Engineering



ANSYS SYLLABUS

S.NO	TOPIC COVERED	DURATION (Hours)
1	INTRODUCTION TO FEA AND	3
2	BASIC SOLID MODELING	3
3	ADVANCED SOLID MODELING	3
4	FINITE ELEMENT MODELING (FEM) - I	3
5	FINITE ELEMENT MODELING (FEM) - II	3
6	SOLUTION AND POSTPROCESSOR	3
7	STATIC STRUCTURAL ANALYSIS	3
8	ADVANCED STRUCTURAL ANALYSIS (DYNAMIC AND NONLINEAR)	3
9	ADVANCED STRUCTURAL ANALYSIS	2
10	THERMAL ANALYSIS	2
11	GENERATING THE REPORT OF ANALYSIS	2

K. Srinivas

PRINCIPAL
25/07/2023
MAHAVEER
INSTITUTE OF TECHNOLOGY
BANDLAGUDA, HYDERABAD

Vysavuri, Bandlaguda Post, Keshavnagar,
Hyderabad-508 005, Telangana INDIA
Tel: 040-84596979, 20020773, Fax: 040-24495003
E-mail: principal.mahaveer@gmail.com
Website: www.mahaveer.in

MAHAVEER



Approved by AICTE, Affiliated to JNTU-KHd

Department of Mechanical Engineering ANSYS Technical Training student attendance list 2018-2019

S.NO.	ROLL NO.	NAME OF THE STUDENT	YEAR
1	15E31A0301	ABDUL ABRAR	IV
2	15E31A0302	ABDUL RAHMAN	IV
3	15E31A0303	ANAND KUMAR	IV
4	15E31A0304	AQUEEB UDDIN FIRDUSHI	IV
5	15E31A0305	ATTLURI SURESH REDDY	IV
6	15E31A0306	BANDA SATYA SHIVA REDDY	IV
7	15E31A0310	BHOOMENI NARENDHAR	IV
8	15E31A0311	BICHKUNDA SUNIL KUMAR	IV
9	15E31A0313	CHIDIRALA RAJKUMAR	IV
10	15E31A0315	DESHAGOUNI MOHAN SAI	IV
11	15E31A0317	GURRALA VENKATA NARSI REDDY	IV
12	15E31A0318	HUSSAIN FAIZ ULLAH	IV
13	15E31A0319	K SAMPATH	IV
14	15E31A0320	KASIREDDY SAINANDI REDDY	IV
15	15E31A0321	KATTA SRIKANTH REDDY	IV
16	15E31A0322	KESHETTI NIKHIL	IV
17	15E31A0325	M A LATEEF	IV
18	15E31A0327	MANCHIKANTI ARAVIND REDDY	IV
19	15E31A0329	MD UBED UL RAHMAN	IV
20	15E31A0331	MOHAMMED ABDULLAH ZUBAIR	IV
21	15E31A0332	MOHAMMED AJAZ	IV

Kishor
PRINCIPAL
MAHAVEER
INSTITUTE OF SCIENCE & TECHNOLOGY
BANDLAGUDA, HYDRABAD-508005

Vasapur, Bandlaguda Post, Keshavnagar,
Hyderabad 500 095, Telangana INDIA
Tel: 040 64536973, 20020773, Fax: 040-24453003
E-mail: principal.mahaveer@gmail.com,
Website: www.mahaveer.ac.in

MAHAVEER



Approved by AICTE, Affiliated to JNTUHYD

22	15E31A0333	MOHAMMED ISMAIL FURQAN	IV
23	15E31A0334	MOHD ABDUL ATIF	IV
24	15E31A0336	MOHD ASIM KHAN	IV
25	15E31A0337	MOHD FARHAN AHMED SHAREEF	IV
26	15E31A0338	MOHD SALA UDDIN	IV
27	15E31A0340	MOHD TALHA	IV
28	15E31A0341	MUDAVATH SRINIVAS	IV
29	15E31A0342	NELLURI AJAY KUMAR	IV
30	15E31A0343	PADAMATINTI AVINASHI	IV
31	15E31A0344	PALNATI SRIKANTH REDDY	IV
32	15E31A0346	POLAKA PARDHA SARADHI REDDY	IV
33	15E31A0349	SABHAVAT SEVYA	IV
34	15E31A0350	SHADMAN ASHRAF	IV
35	15E31A0351	SHAIK ABDUL SAIF	IV
36	15E31A0352	SHAIK ARIF HUSSAIN	IV
37	15E31A0354	SOHAIL MOHAMMED MASOOD AHMED KHAN	IV
38	15E31A0356	SYED BHAUDDIN	IV
39	15E31A0360	SYED QAMAR UDDIN RAZA SHAH QUADRI	IV
40	15E31A0361	SYED SAJJAD AHMED	IV
41	15E31A0362	T KULDEEP SINGH	IV
42	15E31A0363	TANNEERU RAJA	IV
43	15E31A0365	VANGAPALLY SRINIVAS	IV
44	16E35A0301	AMAR BIRADAR	IV
45	16E35A0302	BHUKYA RAMA	IV
46	16E35A0303	DHARAVATH RAVINDER NAYAK	IV
47	16E35A0304	EROJI SURESH	IV

PRINCIPAL
K. S. MAHAVEER
Vasapur, Bandlaguda Post, Keshavnagar,
Hyderabad 500 095, Telangana INDIA
Tel: 040 64536973, 20020773, Fax: 040-24453003

Venugopal Bandlaguda First Reshaugul
Hyderabad-500 005, Telangana-500015
Tel: 040-64596979, 20020773, Fax: 040-24455003
E-mail: principal@mahaveer@gmail.com
Website: www.mahaveer.ac.in

MAHAVEER



Approved by AICTE, Affiliated to JNTU, Hyderabad

48	16E35A0305	GOURAV KUMAR JHA	IV
49	16E35A0306	KALIKOTA SATCHARAN	IV
50	16E35A0307	MANYALA SAFEJA	IV
51	16E35A0308	TADEM BHARATHI KUMAR	IV
52	16E35A0310	TANGELLA ASHOKA VARDHAN RAJU	IV
53	14E31A0303	ANSAR AHMED KHAN	IV
54	14E31A0334	MOHAMMED ABRAR AHMED	IV
55	14E31A0335	MOHAMMED AKIF AHMED	IV
56	14E31A0373	G KARTHIK RAJ	IV
57	14E31A0374	A KAUSHIK VILAS	IV
58	14E31A0386	MOHAMMED SOHAIB	IV
59	14E31A0397	SYED SIKANDER ALI	IV
60	14E31A0398	SYED VIKAYAT ULLAH	IV
61	15E35A0301	E MADHUKAR	IV
62	13E31A0304	AKASH HANVETH	IV
63	14E31A0390	RAHUL SINGH	IV
64	14E31A0376	IMAMD HASAN KHAN	IV
65	14E31A0359	TAMMARASHI AJAY KUMAR	IV
66	13E31A0350	S KUNAL	IV
67	14E31A0341	MOHD KHALIA MOHBUDDIN	IV
68	14E31A0352	SAIFULLAH EKARAN JALKOTE	IV
69	14E31A0337	MOHD ADNAN AZHAR	IV
70	14E31A0339	MOHD ABDUL HAMEED GOURI	IV

S. S. S. S.
PRINCIPAL
MAHAVEER
VENUGOPAL BANDLAGUDA FIRST RESHAUGUL
HYDERABAD-500 005, TELANGANA-500015



Technical Training Exam on ANSYS Software
(A.Y-2018-2019)

2x10=20 Marks

Answer All the Questions

1.

Given the 2D truss structure represented in Figure 1.1, where:

- $h = 5 \text{ m}$
- $L = 5 \text{ m}$
- $P = 1000 \text{ N}$
- $E = 1.0 \times 10^8 \text{ N/m}^2$ (Young's modulus)
- $A = 0.1 \text{ m}^2$ (Cross-section area of each beam element)

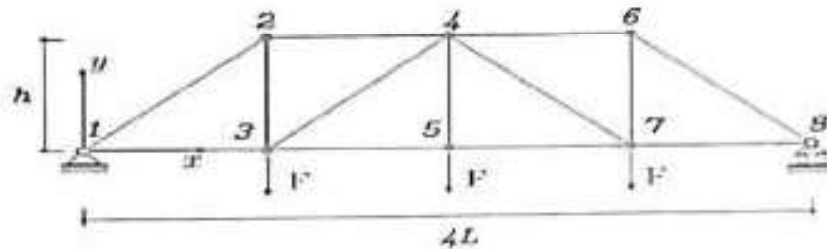

Figure 1.1: Example truss structure, constraints and loads.

2.

- 7.13 Determine the stresses in the plate with the hole subjected to the tensile stress shown in Figure P7-13. Graph the stress variation σ_x versus the distance y from the hole. Let $E = 200 \text{ GPa}$, $\nu = 0.25$, and $r = 25 \text{ mm}$. (Use various mesh densities, depending on your computer program in your finite element model.) Use symmetry as appropriate.



Figure P7-13

Handwritten signature: K. V. Mahaveer
PRINCIPAL
MAHAVEER
INSTITUTE OF TECHNOLOGY AND ENGINEERING
VYSAPUR, BANDLAGUDA POST, KESHAVNAGAR,
HYDERABAD-500 005, TELANGANA INDIA



Department of Mechanical Engineering
ANSYS Technical Training student attendance list 2018-2019

S.NO	Roll No	Name of the student	YEAR	MARKS	PASS/FAIL
1	15E31A0301	ABDUL AHRAR	III	15	PASS
2	15E31A0302	ABDUL RAHMAN	III	16	PASS
3	15E31A0303	ANAND KUMAR	III	14	PASS
4	15E31A0304	AQUEEB UDDIN FIRDUSI	III	15	PASS
5	15E31A0305	ATTLURI SURESH REDDY	III	17	PASS
6	15E31A0306	BANDA SATYA SHIVA REDDY	III	15	PASS
7	15E31A0310	BHOOMENI NARENDHAR	III	16	PASS
8	15E31A0311	BICHKUNDA SUNIL KUMAR	III	16	PASS
9	15E31A0313	CHIDIRALA RAJKUMAR	III	15	PASS
10	15E31A0315	DESHAGOUNI MOHAN SAI	III	15	PASS
11	15E31A0317	GURRALA VENKATA NARSI REDDY	III	16	PASS
12	15E31A0318	HUSSAIN FAIZ ULLAH	III	14	PASS
13	15E31A0319	K SAMPATH	III	15	PASS
14	15E31A0320	KASIREDDY SAIMANOJ REDDY	III	15	PASS
15	15E31A0321	KATTA SRIKANTH REDDY	III	16	PASS
16	15E31A0322	KESHITH NIKHIL	III	14	PASS
17	15E31A0325	M.A LATEEF	III	15	PASS
18	15E31A0327	MANCHIKANTI ARAVIND REDDY	III	17	PASS
19	15E31A0329	MD UBED UL RAHMAN	III	15	PASS
20	15E31A0331	MOHAMMED ABDULLAH ZUBAIR	III	16	PASS
21	15E31A0332	MOHAMMED AIJAZ	III	16	PASS
22	15E31A0333	MOHAMMED ISMAIL FURQAN	III	15	PASS
23	15E31A0334	MOHD ABDUL ATIF	III	16	PASS

PRINCIPAL
 MAHAVEER
 VYSAVI BAI ENGINEERING COLLEGE
 HYD-500 029

Venkatpur, Bandlaguda Post, Keshavnagar,
Hyderabad-500 005, Telangana, India.
Tel: 040-64596379/20020773, Fax: 040-26455003
E-mail: principal.mahaveer@gmail.com
Website: www.mahaveer.in

MAHAVEER



Approved by AICTE, Affiliation No. 2017/01/19/1

24	15E31A0336	MOHD ASIM KHAN	III	14	PASS
25	15E31A0337	MOHD FARHAN AHMED SHAREEF	III	15	PASS
26	15E31A0338	MOHD SALA UDDIN	III	15	PASS
27	15E31A0340	MOHD TALHA	III	16	PASS
28	15E31A0341	MUDAVATH SRINIVAS	III	14	PASS
29	15E31A0342	NELLURI AJAY KUMAR	III	16	PASS
30	15E31A0343	PADAMATINTI AVINASH	III	15	PASS
31	15E31A0344	PALNATI SRIKANTH REDDY	III	14	PASS
32	15E31A0346	POLAKA PARIDHA SARADHI REDDY	III	18	PASS
33	15E31A0349	SABHAVAT SEVYA	III	15	PASS
34	15E31A0350	SHADMAN ASHRAF	III	16	PASS
35	15E31A0351	SHAIK ABDUL SAIF	III	15	PASS
36	15E31A0352	SHAIK ARIF HUSSAIN	III	16	PASS
37	15E31A0354	SOHAIL MOHAMMED MASOOD AHMED KHAN	III	15	PASS
38	15E31A0356	SYED BAHAUDDIN	III	16	PASS
39	15E31A0360	SYED QAMAR UDDIN RAZA SHAH QUADRI	III	15	PASS
40	15E31A0361	SYED SHAHID AHMED	III	14	PASS
41	15E31A0362	T KULDEEP SINGH	III	18	PASS
42	15E31A0363	TANNEERU RAJA	III	15	PASS
43	15E31A0365	VANGAPALLY SRINIVAS	III	16	PASS
44	16E35A0301	AMAR BIRADAR	III	16	PASS
45	16E35A0302	BHUKYA RAMA	III	15	PASS
46	16E35A0303	DILARAVATH RAVINDER NAYAK	III	14	PASS

K. S. Srinivas
PRINCIPAL
MAHAVEER
11/2
11/2/2017

Vysapuri, Bandlaguda Post Keesavuni,
Hyderabad 508 003, Telangana 500016
Tel: 040-64196379-20020773, Fax: 040-2445000
E-mail: principal.mahaveer@gmail.com
Website: www.mst.ac.in

MAHAVEER



Approved by AICTE, Affiliated to JNTUHYD

47	16E35A0304	ERDI SURI SHI	III	18	PASS
48	16E35A0305	GOURAV KUMAR JHA	III	15	PASS
49	16E35A0306	KALIKOTA SAI CHARAN	III	16	PASS
50	16E35A0307	MANYALA SAITEJA	III	15	PASS
51	16E35A0308	TADEM BHARATHI KUMAR	III	16	PASS
52	16E35A0310	TANGELLA ASHOKA VARDHAN RAJU	III	15	PASS
53	14E31A0303	ANSAR AHMED KHAN	III	16	PASS
54	14E31A0334	MOHAMMED ABRAR AHMED	III	15	PASS
55	14E31A0335	MOHAMMED AKIF AHMED	III	14	PASS
56	14E31A0373	G KARTHIK RAJ	III	18	PASS
57	14E31A0374	A KAUSHIK VILAS	III	15	PASS
58	14E31A0386	MOHAMMED SOHAIB	III	16	PASS
59	14E31A0397	SYED SIKANDER ALI	III	15	PASS
60	14E31A0398	SYED VIKAYAT ULLAH	III	16	PASS
61	15E35A0301	E MADHUKAR	III	15	PASS
62	13E31A0304	AKASH HANVETHI	III	16	PASS
63	14E31A0390	RAHUL SINGH	III	15	PASS
64	14E31A0376	IMAMD HANAN KHAN	III	14	PASS
65	14E31A0359	TAMMARASHI AJAY KUMAR	III	18	PASS
66	13E31A0350	S KUNAL	III	15	PASS
67	14E31A0341	MOHD KHAFIA MOHUDDIN	III	16	PASS
68	14E31A0352	SAIFULLAH EKRAM JALKOTE	III	16	PASS
69	14E31A0337	MOHD ADNAN AZHAR	III	15	PASS
70	14E31A0339	MOHD ABDUL HAMEED GOURI	III	14	PASS

K. Srinivas

Principal
MAHAVEER
Vysapuri, Bandlaguda Post Keesavuni,
Hyderabad 508 003, Telangana 500016
Tel: 040-64196379-20020773, Fax: 040-2445000
E-mail: principal.mahaveer@gmail.com
Website: www.mst.ac.in



ANSYS COURSE

Summary

Department of Mechanical Engineering

1. The Geometry preparation training course is for users who want to create and modify geometry in preparation for CFD or FEA analysis. The training will be focused in either ANSYS Design Modeler or ANSYS Space Claim.
2. The ANSYS Meshing training course will give you the tools for generating good quality meshes for Fluent and CFX. The trainee will choose which tool should be used: ANSYS Meshing, Fluent Meshing or ICEM CFD
3. This course will show how to set up a range of simulation types in the ANSYS Fluent or ANSYS CFX solver, as well as how to post process the results by using our CFD Post Tool.
4. This course will show how to set up a range of simulation types in ANSYS Mechanical, as well as how to post process and evaluate your results.
5. To acquire advance knowledge to perform explicit simulations with ANSYS Explicit STR, ANSYS AUTODYN or ANSYS LS-DYNA
6. This is an introductory to intermediate level training for using ANSYS HFSS for all applications, like RF/microwave, antennas or planar problems. Participants will get understanding of HFSS modeling, solution process and post-processing features, which can be used for other advanced applications. The course will also cover advanced topics like dynamic link between EM and circuit, impedance matching, overview of HFSS 3D layout interface and speeding-up HFSS simulation using HPC.
7. Provide the needed tools for the complete simulation of a pressure Vessel from scratch. Several types of analysis and boundary conditions will be discussed, by using pressure vessels examples.
8. To acquire advance knowledge for performing mechanical simulation in Fixed Offshore Structures.

Copy to :

1. Department of Notice Board
2. Principal for Information
3. Committee Members (Academic)

K. Hanu
Principal
MAHAVEER
2022

Vysakhpet, Bandraopada Post Reshaugit,
Hyderabad 500 005, Telangana INDIA
Tel: 040 64591979,20920773, Fax: 040 24458003
E-mail: principal@mahaveer.org
Website: www.mahaveer.org

MAHAVEER



Approved by AICTE - Autonomous Institution

CERTIFICATE OF COURSE COMPLETION

This certificate is presented to ANAND KUMAR of
MIST, who has successfully completed technical training course on
"ANSYS" held from 02-05-2018 to 14-05-2018 and found the
student performance to be excellent.

PRINCIPAL
MAHAVEER
INSTITUTE OF SCIENCE & TECHNOLOGY
Bandraopada, Hyderabad-500 005.

ESTD : 2001

Dr. S. Murugesu
HOD
Department of Mechanical Engineering



DEPARTMENT OF MECHANICAL ENGINEERING

List of students enrolled in ANSYS (2018-2019)

S.No	Roll No	Name of the student	Date	21/5/18	31/5/18	11/5/18	5/5/18	7/5/18	9/5/18	10/5/18	11/5/18	14/5/18
1	15E31A0301	ABDUL ABRAR		P	P	P	P	P	P	P	P	P
2	15E31A0302	ABDUL RAHMAN		P	P	P	P	P	P	P	P	P
3	15E31A0303	ANAND KUMAR		P	P	P	P	P	P	P	P	P
4	15E31A0304	AQUEEB UDDIN FIRDUSHI		P	P	P	P	P	P	P	P	P
5	15E31A0305	ATILURI SURESH REDDY		P	P	P	P	P	P	P	P	P
6	15E31A0306	BANDA SATYA SHIVA REDDY		P	P	P	P	P	P	P	P	P
7	15E31A0310	BHOOMENI NARENDIAR		P	P	P	P	P	P	P	P	P
8	15E31A0311	BICHKUNDA SUNIL KUMAR		P	P	P	P	P	P	P	P	P
9	15E31A0313	CHIDIRALA RAJESH KUMAR		P	P	P	P	P	P	P	P	P
10	15E31A0315	DESHAGOUNI MITHAN SAI		P	P	P	P	P	P	P	P	P
11	15E31A0317	GURRALA VENKATANARSI REDDY		P	P	P	P	P	P	P	P	P
12	15E31A0318	HUSSAIN FAZILUDDIN		P	P	P	P	P	P	P	P	P

K. K. K.
15/5/18

Vysapuri, Bandlaguda Post:Keshavgiri,

MAHAVEER



INSTITUTE OF SCIENCE & TECHNOLOGY

Approved by AICTE, Affiliated to JNTUH,Hyd.

Hyderabad-500 005, TELANGANA INDIA

Tel: 040-64596970,8978380692 Fax: 040-24465003

E-mail: a3hod.h@gmail.com

Website: www.mist.ac.in

DEPARTMENT OF ELECTRONICS AND COMMUNICATION ENGINEERING

MIST/ECE dept./3/2018-19

02-07-2018

To
The Principal
Mahaveer Institute Science & Technology
Hyderabad.

Sir,

Sub: Request for approval to include ADD -ON subject in regular curriculum of B.Tech, ECE

Resource Person: Dr V. N Mani, Scientist F
C-MET, Govt. of India
Hyderabad -500051

In order to increase employability and entrepreneurship for students pursuing B.TECH, department ECE is planning to organise **ROLE OF ADVANCED ELECTRONIC MATERIALS & DEVICES IN SPACE & DEFENCE APPLICATIONS** as add-on course in regular curriculum for AY 2018-19 for B.TECH 4th year semester- I, apart from regular syllabus as per the JNTUH.

Thanking You

[Signature]
HOD, ECE Dept.

[Handwritten Signature]

Principal
MAHAVEER
INSTITUTE OF SCIENCE & TECHNOLOGY
Bandlaguda, Hyderabad-500005

DEPARTMENT OF ELECTRONICS & COMMUNICATION ENGINEERING

Vysapuri, Bandlaguda Post Keshavgirl,
Hyderabad-500 005, AP INDIA
Tel: 040-20620772, 20020773, Fax: 040-24465003
E-mail: e3hpd_ece@gmail.com,
Website: www.misLac.in

MAHAVEER

INSTITUTE OF SCIENCE & TECHNOLOGY
Approved by AICTE, Affiliated to JNTUH,Hyd.



Date: 09/07/2018,

To
Dr.V.N. Mani, Scientist -F
Center for Materials for Electronics & Technology (C-MET), Govt. of India,
Hyderabad-500051

Mobile no. 7382489862

Dear Sir,

As you may be aware, we, **MIST**, are part of the reputed **MAHAVEER** group of educational institutions and have been in the service of imparting quality education to the society since 2001 i.e. last 17 years.

As part of our overall efforts to improve the outlook of students, we regularly invite scientists, engineers, technocrats, academicians and entrepreneurs of repute to visit our institute and share the latest technical developments and valuable learning's from their professional life with our students. As a part of this 'Invited Technical Lectures' series, many individuals of repute have already delivered lectures at our institute for the benefit of our students and faculty.

As you is a well-known expert with deep domain knowledge in the area of **DESIGN OF ELECTRONICS DEVICES**, it would be a great pleasure to us in inviting you for delivering your expert guest lectures to our students for the subject "**ROLE OF ADVANCED ELECTRONIC MATERIALS AND DEVICES IN SPACE AND DEFENCE APPLICATIONS**" approximately two hours duration in a day in every week during 1st Semester.

We are thankful for accepting our request.

The following is the schedule of expert lectures on the subject:-
Every Saturday 3rd & 4th periods, except 2nd Saturday of month.

Thanking you,

Accepted your invitation
11/07/2018

Yours sincerely

ROD, ECE Department,
MIST.

Hyderabad,

Dr. V. N. MANI
Scientist -F
Centre for Materials for Electronics Technology (C-MET)
Ministry of Atomic & Information Technology (M.A.I.T.)
Govt. of India
QA House-II, Chandigarh, HCL (P.O.)
Hyderabad-500 051, Telangana State, India

Handwritten signature

Principal
MIST
INSTITUTE OF SCIENCE & TECHNOLOGY
Bandlaguda, Hyd-500 005

PRINCIPAL
MAHAVEER
INSTITUTE OF SCIENCE & TECHNOLOGY
Bandlaguda, Post-500 005

Vysapuri, Bandlaguda Post:Keshavgiri,

Hyderabad-500 005, TELANGANA INDIA
Tel: 040-64596979,8978380692 Fax: 040-24455003
E-mail: a3hod.it@gmail.com
Website: www.mist.ac.in

MAHAVEER
INSTITUTE OF SCIENCE & TECHNOLOGY
Approved by AICTE, Affiliated to JNTUH Hyd.



DEPARTMENT OF ELECTRONICS AND COMMUNICATION ENGINEERING

ADVANCED-EDC-SYLLABUS

BJT smal signal model – Analysis of CE, CB, CC amplifiers- Gain and frequency response –
MOSFET smal signal model– Analysis of CS and Source folower – Gain and frequency response-
High frequency analysis.

BIMOS cascade amplifier, Diferentialamplifer – Common mode and Diference mode analysis –
FET input stages – Single tuned amplifers – Gain and frequency response – Neutralization
methods, power amplifers –Types (Qualitative analysis).

Advantages of negative feedback – voltage / curent, series , Shunt feedback –positvefeedback –
Conditon for oscilations, phase shift – Wien bridge, Hartley, Colpits and Crystal oscillators.

Duration : 20 to 25 hrs /semester

K. Sankar

MAHAVEER
INSTITUTE OF SCIENCE & TECHNOLOGY
Bandlaguda, Hyd-500 005.

Vysapuri, Bandlaguda Post:Kashavgi,

Hyderabad-500 005, TELANGANA INDIA
Tel: 040-64596979,8978380692, Fax: 040-24465003
E-mail: e3hod.it@gmail.com
Website: www.mist.ac.in,

MAHAVEER

INSTITUTE OF SCIENCE & TECHNOLOGY

Approved by AICTE, Affiliated to JNTUH,Hyd.



DEPARTMENT OF ELECTRONICS AND COMMUNICATION ENGINEERING

Date:12-07-2018

CIRCULAR

Technical Trainings on ROLE OF ADVANCED ELECTRONIC MATERIALS & DEVICES IN SPACE & DEFENCE APPLICATIONS is starting from 16-07-2018 onwards. All the students IV year B. Tech should attend.

Design and development of curriculum for add-on courses :-
Faculty Names: 1. Dr. Jaspal Kumar
2. Mr. M Cheenya
3. Mrs. D Sunitha

HOD, ECE

Cc: Principal for information
: Coordinator to inform the students
: Notice board & department File.

PRINCIPAL
MAHAVEER
INSTITUTE OF SCIENCE & TECHNOLOGY
Bandlaguda, Hyd-500 005.



Vysapuri, Bandlaguda Post:Keshavgiri,

MAHAVEER

INSTITUTE OF SCIENCE & TECHNOLOGY

Approved by AICTE, Affiliated to JNTUH,Hyd.



Hyderabad-500 005, TELANGANA INDIA

Tel: 040-64596979,8978380692 Fax: 040-24456003

E-mail: e3hod.it@gmail.com,

Website: www.mist.ac.in,

DEPARTMENT OF ELECTRONICS AND COMMUNICATION ENGINEERING

STUDENTS REGISTERED

S.No	Hall Ticket No	Name of the Candidate
1	15E31A0403	AKULA SHUCHENDRA
2	15E31A0404	ALLA VENKATAKRISHNA VAMSHI
3	15E31A0405	ALLE VINAY KUMAR
4	15E31A0406	ANNARAM BALAKRISHNA GOUD
5	15E31A0407	B RAKESH
6	15E31A0408	BANDAPELLI SPOORTHY
7	15E31A0409	BHEEKYA YAKANNA
8	15E31A0410	HIRUDU HARINI
9	15E31A0412	BODDU VASU
10	15E31A0413	BONAGIRI SRINIVAS
11	15E31A0414	C UMA
12	15E31A0415	D SAITEJA
13	15E31A0416	DAPPU VENKA LUNI
14	15E31A0417	DOSADA SOWMYA
15	15E31A0418	EDAM SAICHANDANA
16	15E31A0419	GANDLA SAICHANDRA
17	15E31A0421	GODEM MOUNIKA
18	15E31A0422	GOPU KIRAN REDDY
19	15E31A0423	GOVIND SOWMYA
20	15E31A0424	GUNTI PRAKASH
21	15E31A0425	KADICHERLA ASHWINI
22	15E31A0426	KAKIETTI JAISURYA SRINIVASA RAO
23	15E31A0427	KERMA DATHA SAI
24	15E31A0428	M RADHIKA
25	15E31A0432	MOUNIKA THODSAM
26	15E31A0433	NANGLUNURI VISHNU
27	15E31A0435	PABBA SUNDARA CHAITANYA
28	15E31A0436	SAI SRIKANTH YADAV
29	15E31A0438	PALREDDY NARASIMHA REDDY
30	15E31A0439	PASAKAM SAI ABIRSHAK

K. Srinivas

PRINCIPAL
MAHAVEER
INSTITUTE OF SCIENCE & TECHNOLOGY
Bandlaguda, Hyd-500 005.

Vysapuri, Bandlaguda Post:Keshavgiri,

Hyderabad-500 005, TELANGANA INDIA
Tel: 040-64596979,8978380682.Fax: 040-24455003
E-mail: e3hod.it@gmail.com,
Website: www.mist.ac.in,

MAHAVEER

INSTITUTE OF SCIENCE & TECHNOLOGY

Approved by AICTE, Affiliated to JNTUH,Hyd.



DEPARTMENT OF ELECTRONICS AND COMMUNICATION ENGINEERING

32	15E31A0440	PEDDOLA NAVEEN REDDY
32	15E31A0441	FULUGU SUCHITHA REDDY
33	15E31A0442	RAGHAVENDAR PAGIDYALA
34	15E31A0443	KENKUNTA SAIRAM
35	15E31A0444	SANA BEGUM
36	15E31A0445	SAPPIDI KARTHIC REDDY
7	15E31A0446	SATHI VARUN
18	15E31A0447	SHAIK AMAIR HUSSAIN
19	15E31A0448	SUNKARI SRINATH
40	15E31A0450	THIPPARTHI SURYA TEJA
41	15E31A0453	BANALLA DIVVA SAI
42	15E31A0455	BOJIMA PAVANI
43	14E31A0444	P VINEETH REDDY
44	14E31A0451	Rathod Raj Kumar
45	14E31A0456	TodasaarShakthiPratima
46	13E31A0420	J N Sathishrao
47	14E31A0457	V MADHU TEJA
48	14E31A0455	T SHASHANK KUMAR REDDY
49	14E31A0468	D KALYAN
50	14E31A0464	AZMEERA NIKHIL
51	14E31A0492	S DEEKSHIT REJU
52	14E31A04A0	N HARI PRASAD
53	15E35A0410	S RAJ KUMAR

K. Sankar

PRINCIPAL
MAHAVEER
INSTITUTE OF SCIENCE & TECHNOLOGY
Bandlaguda, Hyd-500 005.

Vysapuri, Bandlaguda Post:Keshavgiri,

MAHAVEER

INSTITUTE OF SCIENCE & TECHNOLOGY

Approved by AICTE, Affiliated to JNTUH Hyd.



Hyderabad-500 005, TELANGANA INDIA

Tel: 040-64596979, 8978380692 Fax: 040-24455003

E-mail: e3hod.it@gmail.com,

Website: www.mist.ac.in,

DEPARTMENT OF ELECTRONICS AND COMMUNICATION ENGINEERING

ROLE OF ADVANCED ELECTRONIC MATERIALS & DEVICES IN SPACE & DEFENCE APPLICATIONS:

Duration:120Minutes

4 X 7.5= 30Marks

Answer the following all questions. Each question carries 7.5 marks.

1. Explain the operation of transistor as an amplifier in CB, CC & CE Configurations along with their V-I curves.
2. Input and Output Characteristics Enhancement type N-CH, MOSFET
3. Collector to base bias Operation & Compare it with all other biasing techniques.
4. Explain diode & thermistor Compensation techniques

Kanhit

PRINCIPAL
E.E.T
INSTITUTE OF SCIENCE & TECHNOLOGY
Bandlaguda, Hyd-500 005.

Vysapuri, Bandlaguda Post: Keshavgi,

Hyderabad-500 005, TELANGANA INDIA
Tel: 040-64596979,8978380692 Fax: 040-24455003
E-mail: eshod.it@gmail.com,
Website: www.mist.ac.in.

MAHAVEER

INSTITUTE OF SCIENCE & TECHNOLOGY

Approved by AICTE, Affiliated to JNTUH, Hyd.



DEPARTMENT OF ELECTRONICS AND COMMUNICATION ENGINEERING

STUDENTS ATTENDANCE & RESULT (AY 2018-19)

S.No	Hall Ticket No	Name of the Candidate	ATTENDANCE(20hrs)	Marks Obtained(30)
1	ISE11A0403	AKULA SHUCHENDRA	17	25
2	ISE11A0404	ALLA VENKATA KRISHNA YAMSHI	20	20
3	ISE11A0405	ALLE VINAY KUMAR	18	23
4	ISE11A0406	ANNARAM BALAKRISHNA GOLD	20	20
5	ISE11A0407	B RAKESH	19	27
6	ISE11A0408	BANDAPELLI SPOORTHI	17	24
7	ISE11A0409	BHODKYA YAKANNA	18	21
8	ISE11A0410	BIRUDU HARINI	20	25
9	ISE11A0412	BODDU VASU	20	25
10	ISE11A0413	BONAGIRE SRINIVAS	20	20
11	ISE11A0414	C UMA	20	21
12	ISE11A0415	D SAITEJA	18	21
13	ISE11A0415	DAPPU VENKATESH	19	22
14	ISE11A0417	DORADA SOMMYA	20	23
15	ISE11A0418	EDAMSAI CHANDANA	18	23
16	ISE11A0419	GANDLA SAKHANDRA	20	20
17	ISE11A0421	GODAM MOUNIKA	18	23
18	ISE11A0422	GOPU KIRAN REDDY	17	20
19	ISE11A0423	GOWIND SOMMYA	20	27
20	ISE11A0424	GUNTI PRAKASHI	18	24
21	ISE11A0425	KACHHERLA ASHWINI	20	21
22	ISE11A0426	KAKILETI JAISURYA SRINIVASA RAO	19	25
23	ISE11A0427	KURMA DATTA SAI	17	25
24	ISE11A0428	M KALHIKA	18	20
25	ISE11A0430	MOUNIKA THUDSAM	20	21
26	ISE11A0431	NANGUNURI VISHNU	20	23
27	ISE11A0432	PABBA SUNDARA CHAITANYA	20	22
28	ISE11A0434	SAI SRIKANTH YADAV	20	23
29	ISE11A0433	PALIREDDY NARASIMHA REDDY	18	23
30	ISE11A0434	PASARAM SAI ABHINAV	19	25

Handwritten signature

MAHAVEER INSTITUTE OF SCIENCE & TECHNOLOGY
BANDLAGUDA, HYD-500 005.

Vysapuri, Bandlaguda Post:Keshavgiri,

Hyderabad-500 005, TELANGANA INDIA
Tel: 040-64596979,8978380692,Fax: 040-24455003
E-mail: eshod.it@gmail.com,
Website: www.mist.ac.in,

MAHAVEER

INSTITUTE OF SCIENCE & TECHNOLOGY

Approved by AICTE, Affiliated to JNTUH,Hyd.



DEPARTMENT OF ELECTRONICS AND COMMUNICATION ENGINEERING

12	15E31A0440	PEDDOLLA NAYEEN REDDY	18	23
12	15E31A0441	PULAKU SURESHITHA REDDY	19	26
13	15E31A0442	RAGHAVENDAR PAGIDYALA	20	23
14	15E31A0443	RENKUNTA SAIKUMAR	18	20
15	15E31A0444	SANJEEV REDDY	20	27
16	15E31A0445	SAPPHIDKAR DUK REDDY	18	24
17	15E31A0446	SADHU VARUN	17	21
18	15E31A0447	SHAIK AMAR HUSSAIN	20	25
19	15E31A0448	SUNKARI SRINATH	18	25
20	15E31A0449	THIRUPARTHI SURYA TEJA	20	26
21	15E31A0450	THIRUPARTHI SURYA TEJA	20	26
22	15E31A0451	THIRUPARTHI SURYA TEJA	20	26
23	15E31A0452	THIRUPARTHI SURYA TEJA	20	26
24	15E31A0453	THIRUPARTHI SURYA TEJA	20	26
25	15E31A0454	THIRUPARTHI SURYA TEJA	20	26
26	15E31A0455	THIRUPARTHI SURYA TEJA	20	26
27	15E31A0456	THIRUPARTHI SURYA TEJA	20	26
28	15E31A0457	THIRUPARTHI SURYA TEJA	20	26
29	15E31A0458	THIRUPARTHI SURYA TEJA	20	26
30	15E31A0459	THIRUPARTHI SURYA TEJA	20	26
31	15E31A0460	THIRUPARTHI SURYA TEJA	20	26
32	15E31A0461	THIRUPARTHI SURYA TEJA	20	26
33	15E31A0462	THIRUPARTHI SURYA TEJA	20	26
34	15E31A0463	THIRUPARTHI SURYA TEJA	20	26
35	15E31A0464	THIRUPARTHI SURYA TEJA	20	26
36	15E31A0465	THIRUPARTHI SURYA TEJA	20	26
37	15E31A0466	THIRUPARTHI SURYA TEJA	20	26
38	15E31A0467	THIRUPARTHI SURYA TEJA	20	26
39	15E31A0468	THIRUPARTHI SURYA TEJA	20	26
40	15E31A0469	THIRUPARTHI SURYA TEJA	20	26
41	15E31A0470	THIRUPARTHI SURYA TEJA	20	26
42	15E31A0471	THIRUPARTHI SURYA TEJA	20	26
43	15E31A0472	THIRUPARTHI SURYA TEJA	20	26
44	15E31A0473	THIRUPARTHI SURYA TEJA	20	26
45	15E31A0474	THIRUPARTHI SURYA TEJA	20	26
46	15E31A0475	THIRUPARTHI SURYA TEJA	20	26
47	15E31A0476	THIRUPARTHI SURYA TEJA	20	26
48	15E31A0477	THIRUPARTHI SURYA TEJA	20	26
49	15E31A0478	THIRUPARTHI SURYA TEJA	20	26
50	15E31A0479	THIRUPARTHI SURYA TEJA	20	26
51	15E31A0480	THIRUPARTHI SURYA TEJA	20	26
52	15E31A0481	THIRUPARTHI SURYA TEJA	20	26
53	15E31A0482	THIRUPARTHI SURYA TEJA	20	26
54	15E31A0483	THIRUPARTHI SURYA TEJA	20	26
55	15E31A0484	THIRUPARTHI SURYA TEJA	20	26
56	15E31A0485	THIRUPARTHI SURYA TEJA	20	26
57	15E31A0486	THIRUPARTHI SURYA TEJA	20	26
58	15E31A0487	THIRUPARTHI SURYA TEJA	20	26
59	15E31A0488	THIRUPARTHI SURYA TEJA	20	26
60	15E31A0489	THIRUPARTHI SURYA TEJA	20	26
61	15E31A0490	THIRUPARTHI SURYA TEJA	20	26
62	15E31A0491	THIRUPARTHI SURYA TEJA	20	26
63	15E31A0492	THIRUPARTHI SURYA TEJA	20	26
64	15E31A0493	THIRUPARTHI SURYA TEJA	20	26
65	15E31A0494	THIRUPARTHI SURYA TEJA	20	26
66	15E31A0495	THIRUPARTHI SURYA TEJA	20	26
67	15E31A0496	THIRUPARTHI SURYA TEJA	20	26
68	15E31A0497	THIRUPARTHI SURYA TEJA	20	26
69	15E31A0498	THIRUPARTHI SURYA TEJA	20	26
70	15E31A0499	THIRUPARTHI SURYA TEJA	20	26
71	15E31A0500	THIRUPARTHI SURYA TEJA	20	26
72	15E31A0501	THIRUPARTHI SURYA TEJA	20	26
73	15E31A0502	THIRUPARTHI SURYA TEJA	20	26
74	15E31A0503	THIRUPARTHI SURYA TEJA	20	26
75	15E31A0504	THIRUPARTHI SURYA TEJA	20	26
76	15E31A0505	THIRUPARTHI SURYA TEJA	20	26
77	15E31A0506	THIRUPARTHI SURYA TEJA	20	26
78	15E31A0507	THIRUPARTHI SURYA TEJA	20	26
79	15E31A0508	THIRUPARTHI SURYA TEJA	20	26
80	15E31A0509	THIRUPARTHI SURYA TEJA	20	26
81	15E31A0510	THIRUPARTHI SURYA TEJA	20	26
82	15E31A0511	THIRUPARTHI SURYA TEJA	20	26
83	15E31A0512	THIRUPARTHI SURYA TEJA	20	26
84	15E31A0513	THIRUPARTHI SURYA TEJA	20	26
85	15E31A0514	THIRUPARTHI SURYA TEJA	20	26
86	15E31A0515	THIRUPARTHI SURYA TEJA	20	26
87	15E31A0516	THIRUPARTHI SURYA TEJA	20	26
88	15E31A0517	THIRUPARTHI SURYA TEJA	20	26
89	15E31A0518	THIRUPARTHI SURYA TEJA	20	26
90	15E31A0519	THIRUPARTHI SURYA TEJA	20	26
91	15E31A0520	THIRUPARTHI SURYA TEJA	20	26
92	15E31A0521	THIRUPARTHI SURYA TEJA	20	26
93	15E31A0522	THIRUPARTHI SURYA TEJA	20	26
94	15E31A0523	THIRUPARTHI SURYA TEJA	20	26
95	15E31A0524	THIRUPARTHI SURYA TEJA	20	26
96	15E31A0525	THIRUPARTHI SURYA TEJA	20	26
97	15E31A0526	THIRUPARTHI SURYA TEJA	20	26
98	15E31A0527	THIRUPARTHI SURYA TEJA	20	26
99	15E31A0528	THIRUPARTHI SURYA TEJA	20	26
100	15E31A0529	THIRUPARTHI SURYA TEJA	20	26

K. Srinivas

PRINCIPAL
MA:
INSTITUTE OF SCIENCE & TECHNOLOGY
Bandlaguda, Hyd-500 005

26	15E31A0433	NANGUNURI VISHNU	1	7	3	4	5	6	7	8	9	10	11	12	13	14	15	16	17	18	19	20
27	15E31A0435	P S CHAITANYA	1	2	3	4	5	6	7	8	9	10	11	12	13	14	15	16	17	18	19	20
28	15E31A0436	S BRIKANTH YADAV	1	2	3	4	5	6	7	8	9	10	11	12	13	14	15	16	17	18	19	20
29	15E31A0438	P NARASIMHAR	1	2	3	4	5	6	7	8	9	10	11	12	13	14	15	16	17	18	19	20
30	15E31A0439	PSAI ABHISHEK	1	2	3	4	5	6	7	8	9	10	11	12	13	14	15	16	17	18	19	20
32	15E31A0440	P NAVEEN REDDY	1	2	3	4	5	6	7	8	9	10	11	12	13	14	15	16	17	18	19	20
32	15E31A0441	P SUCHITHA REDDY	1	2	3	4	5	6	7	8	9	10	11	12	13	14	15	16	17	18	19	20
33	15E31A0442	R PAGIDYALA	1	2	3	4	5	6	7	8	9	10	11	12	13	14	15	16	17	18	19	20
34	15E31A0443	RENKUNTA SAIRAM	1	2	3	4	5	6	7	8	9	10	11	12	13	14	15	16	17	18	19	20
35	15E31A0444	SAVA BEGUM	1	2	3	4	5	6	7	8	9	10	11	12	13	14	15	16	17	18	19	20
35	15E31A0445	SKARTHIK REDDY	1	2	3	4	5	6	7	8	9	10	11	12	13	14	15	16	17	18	19	20
37	15E31A0446	GATHI VARUN	1	2	3	4	5	6	7	8	9	10	11	12	13	14	15	16	17	18	19	20
38	15E31A0447	SAMAR MUHAMMAD	1	2	3	4	5	6	7	8	9	10	11	12	13	14	15	16	17	18	19	20
38	15E31A0448	SUNKARI SRINIVAS	1	2	3	4	5	6	7	8	9	10	11	12	13	14	15	16	17	18	19	20
40	15E31A0450	T SURYA TEJA	1	2	3	4	5	6	7	8	9	10	11	12	13	14	15	16	17	18	19	20
41	15E31A0463	BANALLA DIVYA SAI	1	2	3	4	5	6	7	8	9	10	11	12	13	14	15	16	17	18	19	20
42	15E31A0455	BOMMA PAVANI	1	2	3	4	5	6	7	8	9	10	11	12	13	14	15	16	17	18	19	20
43	15E31A0464	P VINETHI REDDY	1	2	3	4	5	6	7	8	9	10	11	12	13	14	15	16	17	18	19	20
44	15E31A0465	Ramesh Raj Kumar	1	2	3	4	5	6	7	8	9	10	11	12	13	14	15	16	17	18	19	20
45	15E31A0468	T Shakthi Praganna	1	2	3	4	5	6	7	8	9	10	11	12	13	14	15	16	17	18	19	20
46	15E31A0420	J N Srinanth Babu	1	2	3	4	5	6	7	8	9	10	11	12	13	14	15	16	17	18	19	20
47	15E31A0457	V MADHUTEJA	1	2	3	4	5	6	7	8	9	10	11	12	13	14	15	16	17	18	19	20
48	15E31A0455	TS KUMAR REDDY	1	2	3	4	5	6	7	8	9	10	11	12	13	14	15	16	17	18	19	20
48	15E31A0468	D MALYAN	1	2	3	4	5	6	7	8	9	10	11	12	13	14	15	16	17	18	19	20
50	15E31A0472	AJEEFERA NIKHIL	1	2	3	4	5	6	7	8	9	10	11	12	13	14	15	16	17	18	19	20
51	15E31A0492	S DEEKSHIT REJU	1	2	3	4	5	6	7	8	9	10	11	12	13	14	15	16	17	18	19	20
52	15E31A0440	N HARI PRASAD	1	2	3	4	5	6	7	8	9	10	11	12	13	14	15	16	17	18	19	20
53	15E35A0410	S RAJ KUMAR	1	2	3	4	5	6	7	8	9	10	11	12	13	14	15	16	17	18	19	20

Handwritten signature

Co-ordinator

Handwritten signature

Vysapuri, Bandlaguda Post:Keshavgiri,

Hyderabad-500 005, TELANGANA INDIA
Tel: 040-64596979,8978380692,Fax: 040-24455003
E-mail: e3hod.it@gmail.com
Website: www.mist.ac.in

MAHAVEER

INSTITUTE OF SCIENCE & TECHNOLOGY

Approved by AICTE, Affiliated to JNTUH,Hyd.



DEPARTMENT OF ELECTRONICS AND COMMUNICATION ENGINEERING

MIST/ECE dept. /1/ 2018-19

07-12-2018

To
The Principal
Mahaveer Institute Science & Technology
Hyderabad.

Sir,
Sub: Reques,Lt for approval to include ADD -ON subject in regular curriculum of B.Tech, ECE
Resource Person: Dr V. N Mani, Scientist F
C-MET, Govt. of India
Hyderabad -500051

In order to increase employability and entrepreneurship for students pursuing B.TECH , department ECE is planning to organize **Advance VLSI TECHNOLOGY** as add-on course in regt curriculum for 4th year Btech, II SEMESTER, AY 2018-19 apart from regular syllabus as per JNTEH.

Thanking You

HOD, ECE

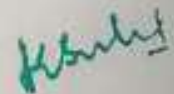

PRINCIPAL
MIST
INSTITUTE
Bandlaguda, Hyd-500

Vysapuri, Bandlaguda Post:Keshavgi.

MAHAVEER

INSTITUTE OF SCIENCE & TECHNOLOGY

Approved by AICTE, Affiliated to JNTUH, Hyd.



Hyderabad-500 005, TELANGANA INDIA
Tel: 040-64596979,8978380692 Fax: 040-24455003
E-mail: g3hod.it@gmail.com,
Website: www.mist.ac.in,

DEPARTMENT OF ELECTRONICS AND COMMUNICATION ENGINEERING

SYLLABUS : ADVANCED VLSI DESIGN

- Digital Integrated Circuit Design
 - CMOS standard cell characteristics
 - Delay calculation (Elmore model, Logical Effort)
 - Low power design
 - Static Timing Analysis
 - Digital ASIC design flow
- Analog Integrated Circuit Design
 - Device Physics of the MOSFET
 - Physics Insights: MOSFET as a Switch
 - Analytical Techniques: Low and High frequency analysis, Noise analysis
 - Feedback
 - OPAMP Design
 - Oscillators and Phase Locked Loops
 - Analog Integrated Circuits Beyond Silicon
- Emerging Technologies
 - Open Source Processor Architecture (RISC-V)
 - Neuromorphic Computing
 - Edge Computing
 - Flexible Electronics
- Advanced Digital Design and FPGA based Design
 - VLSI Micro-architecture Design
 - Timing Closure
 - High Throughput Computing
 - FPGA Based System Design
 - Processor Design

Duration : 20 to 25 hrs /semester

K. K. K.

PRINCIPAL
MAHAVEER
INSTITUTE OF SCIENCE & TECHNOLOGY
Bandlaguda, Hyd-500 005.

DEPARTMENT OF ELECTRONICS & COMMUNICATION ENGINEERING

Vysapuri, Bandlaguda Post:Keshavgirl,
Hyderabad-500 005, AP INDIA
Tel: 040-20020772,20020773, Fax: 040-24455003
E-mail: g3hod.ecce@gmail.com,
Website: www.mist.ac.in

MAHAVEER

INSTITUTE OF SCIENCE & TECHNOLOGY

Approved by AICTE, Affiliated to JNTUH,Hyd.



Date: 17/12/2018.

To
Dr.V.N. Mani, Scientist-E
Center for Materials for Electronics & Technology (C-MET), Govt of India,
Hyderabad-500051

Mobile no: 7382489862

Dear Sir,

As you may be aware, we, MIST, are part of the reputed MAHAVEER group of educational institutions and have been in the service of imparting quality education to the society since 2001 i.e. last 17 years.

As part of our overall efforts to improve the outlook of students, we regularly invite scientists, engineers, technocrats, academicians and entrepreneurs of repute to visit our institute and share the latest technical developments and valuable learning's from their professional life with our students. As a part of this 'Invited Technical Lecture' series, many individuals of repute have already delivered lectures at our institute for the benefit of our students and faculty.

As you is a well-known expert with deep domain knowledge in the area of **DESIGN OF ELETRONICS DEVICES**. It would be a great pleasure to us in inviting you for delivering yours expert guest lectures to our students for the subject "**Advanced VLSI Technology**" approximately two hours duration in a day in every week during IInd Semester.

We are thankful for accepting our request.

The following is the schedule of expert lectures on the subject:-
Every Saturday 3rd & 4th periods, except 2nd Saturday of month.

Thanking you,

Accepted the invitation
[Signature]
19/12/2018

Yours sincerely

[Signature]

HOD, ECE Department,
MIST.

Hyderabad,

Dr. V. N. MANI
Scientist-E
Center for Material for Electronics Technology (C-MET)
Ministry of Electronics & Information Technology (MeitY)
Govt. of India
IIT Phase-II, Cheruvu, Hyderabad-500 031, Telangana State, India

[Signature]

PRINCIPAL
MAHAVEER
INSTITUTE OF SCIENCE & TECHNOLOGY
Bandlaguda, Hyderabad-500 005

[Signature]
PRINCIPAL
MAHAVEER
INSTITUTE OF SCIENCE & TECHNOLOGY
Bandlaguda, Hyderabad-500 005

Vysapuri, Bandlaguda Post:Keshavgi.

MAHAVEER

INSTITUTE OF SCIENCE & TECHNOLOGY

Approved by AICTE, Affiliated to JNTUH,Hyd.



Hyderabad-500 005, TELANGANA INDIA
Tel: 040-64596979,8978380692, Fax: 040-24455003
E-mail: e3hod.it@gmail.com,
Website: www.mist.ac.in,

DEPARTMENT OF ELECTRONICS AND COMMUNICATION ENGINEERING

Date:19-12-2018

CIRCULAR

Technical Trainings on **Advance VLSI TECHNOLOGY** is starting from **22-12-2018** onwards. All the students IV year .BTech should attend

Design and development of curriculum for add-on courses:

Faculty Names: 1.Dr. Jaspal Kumar
2.Mr.M. Deva Raju
3. Mr. K. Venkateshwarlu

HOD, ECE

Cc: Principal for information
: Coordinator to inform the students
: Notice board & department File



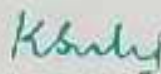

PRINCIPAL
MAHAVEER
INSTITUTE OF SCIENCE & TECHNOLOGY
Bandlaguda, HYD-500 005.

Vysapuri, Bandlaguda Post:Keshavgiri,

MAHAVEER

INSTITUTE OF SCIENCE & TECHNOLOGY

Approved by AICTE. Affiliated to JNTUH,Hyd.



Hyderabad-500 005, TELANGANA INDIA

Tel: 040-64596979,8978380692 Fax: 040-24455003

E-mail: e3hod_it@gmail.com,

Website: www.mist.ac.in,

DEPARTMENT OF ELECTRONICS AND COMMUNICATION ENGINEERING

STUDENTS REGISTERED

S.No	Hall Ticket No	Name of the Candidate
1	1SE31A0403	AKULA SHUCHINDRA
2	1SE31A0404	ALLA VENKATA KRISHNA VAMSHI
3	1SE31A0405	ALLE VINAY KUMAR
4	1SE31A0406	ANNARAM BALAKRISHNA GOUD
5	1SE31A0407	B RAKESH
6	1SE31A0408	BANDAPELLI SPOORTHY
7	1SE31A0409	BHOOKYA YAKANNA
8	1SE31A0410	BIRUDU HARINI
9	1SE31A0412	BODDI VASTI
10	1SE31A0413	BONAGERI SRINIVAS
11	1SE31A0414	C IMA
12	1SE31A0415	D SAITJA
13	1SE31A0416	DAPPU VENKATESH
14	1SE31A0417	DOSADA SOMMYA
15	1SE31A0418	EDAM SAICHANDANA
16	1SE31A0419	GANDLA SAICHANDRA
17	1SE31A0421	GODEN MOUNIKA
18	1SE31A0422	GOPI KIBAN REDDY
19	1SE31A0423	GOVIND SOMMYA
20	1SE31A0424	GUNTI PRAKASH
21	1SE31A0425	KADICHERLA ASHWINI
22	1SE31A0426	KAKLETTI JASHRYA SRINIVASA RAO
23	1SE31A0427	KURMA DATTA SAI
24	1SE31A0428	M RATHIKA
25	1SE31A0432	MOUNIKA THOOSAM
26	1SE31A0433	NANCUNURI VISHNU
27	1SE31A0435	PABBA SINDARA CHAITANYA
28	1SE31A0438	SAI SRICANTH YADAV
29	1SE31A0438	PALKEEDY NARASIMHA REDDY
30	1SE31A0439	PASARAM SAI ABHIRAM

K. Sankar
PRINCIPAL
MAHAVEER
INSTITUTE OF SCIENCE & TECHNOLOGY
Bandlaguda, Hyd-500 005.

Vysapuri, Bandlaguda Post:Keshavgiri,

MAHAVEER

INSTITUTE OF SCIENCE & TECHNOLOGY

Approved by AICTE, Affiliated to JNTUH,Hyd.



Hyderabad-500 005, TELANGANA INDIA

Tel: 040-64596979,8978380692,Fax: 040-24455003

E-mail: e3hod.it@gmail.com,

Website: www.mist.ac.in,

DEPARTMENT OF ELECTRONICS AND COMMUNICATION ENGINEERING

32	15E11A0441	PEDDOLLA NAVEEN REDDY
32	15E11A0441	PULUGU SUCHETHA REDDY
33	15E11A0442	RAGHAVENDAR PAGIDYALA
34	15E11A0443	RENKUNTA SAIKAM
35	15E11A0444	SANA BEGRIM
36	15E11A0445	SAPPIDI KARTHIK REDDY
7	15E11A0446	SATHI VARUN
38	15E11A0447	SHAIK AMAJE HOSSAIN
39	15E11A0448	SUNCARI SRINATH
40	15E11A0450	THIPPARTHI SURYA TEJA
41	15E11A0453	BANAJALA DIVYA SAI
42	15E11A0455	BOMMA PAVANI
43	14E11A0444	P VINEETH REDDY
44	13E11A0420	J N Srikanth Babu
45	14E11A0457	V MADHU TEJA
46	14E11A0455	T SHASHANK KUMAR REDDY
47	14E11A0448	D KALYAN
48	14E11A0464	AZMEERA NIKHIL
49	14E11A0492	S DEEKSHIT REJU
50	14E11A0440	N BHARU PRASAD
51	15E15A0410	S RAJ KUMAR

Khandy

Principal
MAHAVEER
INSTITUTE OF SCIENCE & TECHNOLOGY
Bandlaguda, Hyd-500 005

Vysapuri, Bandlaguda Post, Keshavgiri,

Hyderabad-500 005, TELANGANA INDIA
Tel: 040-64596979, 8976380692 Fax: 040-24455003
E-mail: eshod_m@gmail.com
Website: www.mist.ac.in

MAHAVEER

INSTITUTE OF SCIENCE & TECHNOLOGY

Approved by AICTE, Affiliated to JNTUH, Hyd.



DEPARTMENT OF ELECTRONICS AND COMMUNICATION ENGINEERING

QUESTION PAPER

ADVANCED VLSI DESIGN

Duration: 120 Minutes

4 X 7.5 = 30 Marks

Answer the following all questions. Each question carries 7.5 marks.

1. Explain with neat diagram the architecture of FPGA.
2. Explain about wiring capacitance, fan in, fan out, choice of layers.
3. Discuss the advantages of SRAM over DRAM.
4. Compare CPLD and FPGA in all respects.

K. Sankar

PRINCIPAL
MAHAVEER
INSTITUTE OF SCIENCE & TECHNOLOGY
Bandlaguda, Hyd-500 005

Vysapuri, Bandlaguda Post: Keshavgiri,

MAHAVEER

INSTITUTE OF SCIENCE & TECHNOLOGY

Approved by AICTE, Affiliated to JNTUH, Hyd.



Hyderabad-500 005, TELANGANA INDIA

Tel: 040-64596979, 8978380692 Fax: 040-24455003

E-mail: ejhod.it@gmail.com

Website: www.mist.ac.in

DEPARTMENT OF ELECTRONICS AND COMMUNICATION ENGINEERING

STUDENTS ATTENDANCE & RESULT (AY 2018-19)

S.No	Hall Ticket No	Name of the Candidate	ATTENDANCE (20hrs)	Marks Obtained (30)
1	15E31A0403	AKULA SHUCHENDRA	20	23
2	15E31A0404	ALLA VENKATA KRISHNA YAMSHI	19	20
3	15E31A0405	ALLE VINAY KUMAR	17	23
4	15E31A0406	ANNARAM BALAKRISHNA GOUD	18	20
5	15E31A0407	B RAKESH	20	27
6	15E31A0408	BANDAPELLI SPOORTHU	20	24
7	15E31A0409	BHOOKYA YAKANNA	18	21
8	15E31A0410	DIRUDU HARINI	20	26
9	15E31A0412	BODDU VASU	19	26
10	15E31A0413	BONADIRI SRINIVAS	17	20
11	15E31A0414	C UMA	18	21
12	15E31A0415	D SATEJA	20	23
13	15E31A0416	DAPPU VENKATESH	20	20
14	15E31A0417	DOSADA SOWMYA	18	19
15	15E31A0418	EDAM SAICHANDANA	20	17
16	15E31A0419	GANDLA SAICHANDRA	19	18
17	15E31A0421	GODEM MOUNIKA	20	20
18	15E31A0422	GOPI KIRAN REDDY	18	20
19	15E31A0423	GOVIND SOWMYA	20	18
20	15E31A0424	GLINTI PRAKASH	18	20
21	15E31A0425	KADACHERLA ASHWINI	17	19
22	15E31A0426	KAKILETI JAISURYA SRINIVASA BAO	20	17
23	15E31A0427	KURMA DATTA SAI	18	18
24	15E31A0428	M RADHIKA	20	20
25	15E31A0432	MOUNIKA THODSAM	19	20
26	15E31A0433	NANGUNURI VISHNU	17	21
27	15E31A0435	PABBA SUNDARA CHAITANYA	18	22
28	15E31A0436	SAI SRIKANTI YADAV	20	25
29	15E31A0438	PAIREDDY NARASIMHA REDDY	20	22
30	15E31A0439	PASARAM SAI ABHISHEK	18	20

Kishu

Principal
M. S. S. S. S.
Bandlaguda, Hyd-500 005

Vysapuri, Bandlaguda Post:Keshavgi,

MAHAVEER

INSTITUTE OF SCIENCE & TECHNOLOGY

Approved by AICTE, Affiliated to JNTUH,Hyd.



Hyderabad-500 005, TELANGANA INDIA

Tel: 040-64596979,8978380692,Fax: 040-24455003

E-mail: e3hod.it@gmail.com,

Website: www.mist.ac.in,

DEPARTMENT OF ELECTRONICS AND COMMUNICATION ENGINEERING

32	15E31A0440	PEDDOLA NAVEEN REDDY	18	23
32	15E31A0441	PULUGU SUCHITHA REDDY	19	29
33	15E31A0442	RAJHAVENDAR PAGIDYALA	20	23
34	15E31A0443	RENKUNTA SADRAM	18	20
35	15E31A0444	SANA BEGUM	20	27
36	15E31A0445	SAPPIDI KARTHIK REDDY	18	24
7	15E31A0446	SATHYARUN	17	21
38	15E31A0447	SHAIK AMAIR HUSSAIN	20	25
39	15E31A0448	SUNKARI BINATHI	18	24
40	15E31A0450	THIPPARTHSURYA TEJA	20	20
41	15E31A0453	BANALLA DIVYA SAI	19	21
42	15E31A0455	BOMMA PAVANI	17	23
43	14E31A0444	P VINEETH REDDY	18	22
44	15E31A0420	J N SriLaxmiBabu	20	29
45	14E31A0457	V MADHU TEJA	20	23
46	14E31A0455	T SHASHANK KUMAR REDDY	18	20
47	14E31A0468	D KALYAN	19	27
48	14E31A0464	AZMEERA NIKHIL	18	24
49	14E31A0492	S DEEKSHIT REJU	19	21
50	14E31A0440	N HARI PRASAD	20	26
51	15E35A0410	S RAJ KUMAR	18	25

Kanhu

PRE
M. S. S. S.
INSTITUTE OF SCIENCE &
Bandlaguda, Hyd-500

STUDENTS REGISTERED ATTENDANCE & RESULT (AY 2018-19)

S No	Roll Number	Name of the Candidate	1	2	3	4	5	6	7	8	9	10	11	12	13	14	15	16	17	18	19	20	
1	18E110001	ANILA S JIJENDRA	19	1	2	3	4	5	6	7	8	9	10	11	12	13	14	15	16	17	18	19	20
2	18E110002	A VISHVANATHAN	19	1	2	3	4	5	6	7	8	9	10	11	12	13	14	15	16	17	18	19	20
3	18E110003	ALFREDY KUMAR	19	1	2	3	4	5	6	7	8	9	10	11	12	13	14	15	16	17	18	19	20
4	18E110004	A RAJASUBRAMANIAM	19	1	2	3	4	5	6	7	8	9	10	11	12	13	14	15	16	17	18	19	20
5	18E110005	J. RAJESH	19	1	2	3	4	5	6	7	8	9	10	11	12	13	14	15	16	17	18	19	20
6	18E110006	RAMAREDDY SPOORATHI	19	1	2	3	4	5	6	7	8	9	10	11	12	13	14	15	16	17	18	19	20
7	18E110007	BHAGYAVATHI	19	1	2	3	4	5	6	7	8	9	10	11	12	13	14	15	16	17	18	19	20
8	18E110008	SHRILAL HANU	19	1	2	3	4	5	6	7	8	9	10	11	12	13	14	15	16	17	18	19	20
9	18E110009	RODRI VASU	19	1	2	3	4	5	6	7	8	9	10	11	12	13	14	15	16	17	18	19	20
10	18E110010	SOULTAN SATHIYAS	19	1	2	3	4	5	6	7	8	9	10	11	12	13	14	15	16	17	18	19	20
11	18E110011	D. MANI	19	1	2	3	4	5	6	7	8	9	10	11	12	13	14	15	16	17	18	19	20
12	18E110012	CHAITANYA	19	1	2	3	4	5	6	7	8	9	10	11	12	13	14	15	16	17	18	19	20
13	18E110013	DARSHAN KATEEM	19	1	2	3	4	5	6	7	8	9	10	11	12	13	14	15	16	17	18	19	20
14	18E110014	DOBDEL SOMAYA	19	1	2	3	4	5	6	7	8	9	10	11	12	13	14	15	16	17	18	19	20
15	18E110015	EDAM SATHYANANDA	19	1	2	3	4	5	6	7	8	9	10	11	12	13	14	15	16	17	18	19	20
16	18E110016	GANESH SACHANDRA	19	1	2	3	4	5	6	7	8	9	10	11	12	13	14	15	16	17	18	19	20
17	18E110017	SHARMA ANANDA	19	1	2	3	4	5	6	7	8	9	10	11	12	13	14	15	16	17	18	19	20
18	18E110018	SZABU KHAN BEECY	19	1	2	3	4	5	6	7	8	9	10	11	12	13	14	15	16	17	18	19	20
19	18E110019	GRINO SOMAYA	19	1	2	3	4	5	6	7	8	9	10	11	12	13	14	15	16	17	18	19	20
20	18E110020	DAKSHINAMURTHI	19	1	2	3	4	5	6	7	8	9	10	11	12	13	14	15	16	17	18	19	20
21	18E110021	VADICHETANANATHAN	19	1	2	3	4	5	6	7	8	9	10	11	12	13	14	15	16	17	18	19	20
22	18E110022	K. J. BHAVANATHAN	19	1	2	3	4	5	6	7	8	9	10	11	12	13	14	15	16	17	18	19	20
23	18E110023	KURIMA DATHA SAI	19	1	2	3	4	5	6	7	8	9	10	11	12	13	14	15	16	17	18	19	20
24	18E110024	V. ANITHA	19	1	2	3	4	5	6	7	8	9	10	11	12	13	14	15	16	17	18	19	20
25	18E110025	ADURMANI THIRISAN	19	1	2	3	4	5	6	7	8	9	10	11	12	13	14	15	16	17	18	19	20

M. S. S. Institute of Technology
 Bangalore, Mysore

36	HEJMANOVIC	HEJMANOVIC	1	2	3	4	5	6	7	8	9	10	11	12	13	14	15	16	17	18	19	20
37	HEJMANOVIC	HEJMANOVIC	1	2	3	4	5	6	7	8	9	10	11	12	13	14	15	16	17	18	19	20
38	HEJMANOVIC	HEJMANOVIC	1	2	3	4	5	6	7	8	9	10	11	12	13	14	15	16	17	18	19	20
39	HEJMANOVIC	HEJMANOVIC	1	2	3	4	5	6	7	8	9	10	11	12	13	14	15	16	17	18	19	20
40	HEJMANOVIC	HEJMANOVIC	1	2	3	4	5	6	7	8	9	10	11	12	13	14	15	16	17	18	19	20
41	HEJMANOVIC	HEJMANOVIC	1	2	3	4	5	6	7	8	9	10	11	12	13	14	15	16	17	18	19	20
42	HEJMANOVIC	HEJMANOVIC	1	2	3	4	5	6	7	8	9	10	11	12	13	14	15	16	17	18	19	20
43	HEJMANOVIC	HEJMANOVIC	1	2	3	4	5	6	7	8	9	10	11	12	13	14	15	16	17	18	19	20
44	HEJMANOVIC	HEJMANOVIC	1	2	3	4	5	6	7	8	9	10	11	12	13	14	15	16	17	18	19	20
45	HEJMANOVIC	HEJMANOVIC	1	2	3	4	5	6	7	8	9	10	11	12	13	14	15	16	17	18	19	20
46	HEJMANOVIC	HEJMANOVIC	1	2	3	4	5	6	7	8	9	10	11	12	13	14	15	16	17	18	19	20
47	HEJMANOVIC	HEJMANOVIC	1	2	3	4	5	6	7	8	9	10	11	12	13	14	15	16	17	18	19	20
48	HEJMANOVIC	HEJMANOVIC	1	2	3	4	5	6	7	8	9	10	11	12	13	14	15	16	17	18	19	20
49	HEJMANOVIC	HEJMANOVIC	1	2	3	4	5	6	7	8	9	10	11	12	13	14	15	16	17	18	19	20
50	HEJMANOVIC	HEJMANOVIC	1	2	3	4	5	6	7	8	9	10	11	12	13	14	15	16	17	18	19	20
51	HEJMANOVIC	HEJMANOVIC	1	2	3	4	5	6	7	8	9	10	11	12	13	14	15	16	17	18	19	20

Co-ordinator

Handwritten signature

Handwritten signature

PRINCIPAL
MAHARVEE
INSTITUTE OF SCIENCES & TECH.
SANDLAGUDA, HYD 500 075.

Vysapuri, Bandlaguda Post:Keshavgiri,

MAHAVEER

INSTITUTE OF SCIENCE & TECHNOLOGY

Approved by AICTE, Affiliated to JNTUH,Hyd.



Hyderabad-500 005, TELANGANA INDIA

Tel: 040-64596979,8978380692 Fax: 040-24455003

E-mail: e3hod.cse@gmail.com,

Website: www.mist.ac.in,

DEPARTMENT OF COMPUTER SCIENCE AND ENGINEERING

Date: 02-09-2019

CIRCULAR

Technical Trainings for III & IV B. Tech students are starting from **16-09-2019** onwards. All HODs and placements coordinators have to manage the trainings and ensure 95% attendance all through the sessions.

All mentors need to send the compiled feedback report to HOD at e3hod.cse@gmail.com daily. Mentors are advised to take care of PNR (Students not participating in training).

Agenda: **Angular JS**

HOD-CSE

PRINCIPAL
MAHAVEER
INSTITUTE OF SCIENCE & TECHNOLOGY
Bandlaguda, Hyderabad-500005

Vysapuri, Bandlaguda Post: Keshavgiri,

Hyderabad-500 005, TELANGANA INDIA

Tel: 040-64596979,8978380692 Fax: 040-24455003

E-mail: e3hod.cse@gmail.com.

Website: www.mist.ac.in.

MAHAVEER

INSTITUTE OF ENGINEERING & TECHNOLOGY

Approved by AICTE, Affiliated to JNTUH,Hyd



DEPARTMENT OF COMPUTER SCIENCE AND ENGINEERING

SYLLABUS FOR Angular Js

SNO	TOPIC COVERED	DURATION
1	Introduction to HTML	1
2	Introduction to CSS	1
3	Introduction to JavaScript	1
4	Working with Objects	1
5	Angular JS Basics	1
6	Angular Expressions	1
7	Filters	1
8	Directives	1
9	Controllers	1
10	Angular JS Modules	1
11	Angular JS Forms	1
12	Scope	1
13	Dependency Injection & Services	1
14	Single Page Application (SPA)	1
15	Angular JS Animation	1
16	Introduction to Node JS	1
17	Setup Development Environment	1
18	Node JS Modules	1
19	Node Package Manager	1
20	Creating Web Server	1
21	File System	1
22	Debugging Node JS Application, Events	3
23	Express JS	1

K. Srinivas

PRINCIPAL
MAHAVEER

INSTITUTE OF ENGINEERING & TECHNOLOGY
Bandlaguda, Hyd-500 005

Vysapuri, Bandlaguda Post:Keshavgi.

MAHAVEER

INSTITUTE OF SCIENCE & TECHNOLOGY

Approved by AICTE, Affiliated to JNTUH,Hyd.



Hyderabad-500 005, TELANGANA INDIA

Tel: 040-64596979,8978380692.Fax: 040-24455003

E-mail: e3hod.cse@gmail.com.

Website: www.mist.ac.in,

DEPARTMENT OF COMPUTER SCIENCE AND ENGINEERING

24	Serving Static Resources	2
25	Database Connectivity	1
26	Project Development	2

HOD-CSE



PRINCIPAL
MAHAVEER
INSTITUTE OF SCIENCE & TECHNOLOGY
Bandlaguda, Hyd-500 005.

Vysapuri, Bandlaguda Post:Keshavgirl,

Hyderabad-500 005, TELANGANA INDIA
Tel: 040-64596979,8978380892,Fax: 040-24465003
E-mail: e3hod.cae@gmail.com,
Website: www.mist.ac.in,

MAHAVEER

INSTITUTE OF SCIENCE & TECHNOLOGY
Approved by AICTE, Affiliated to JNTUH,Hyd.



DEPARTMENT OF COMPUTER SCIENCE AND ENGINEERING

LIST OF REGISTERED STUDENTS FOR Angular js

SNO	HALL TICKET NO	NAME OF THE STUDENT
1	17E31A0501	A SHIRISHA
2	17E31A0502	BANDARI VARUN KUMAR
3	17E31A0504	BOGEE SUPRIYA
4	17E31A0507	CHEEMALA MAHESH
5	17E31A0508	CHELLOJU ANUSHA
6	17E31A0509	CHENCHU HARISH
7	17E31A0510	D GANESH
8	17E31A0512	G.HARIKA
9	17E31A0514	GANECHARY SHREYA
10	17E31A0515	GEETHIKA C
11	17E31A0516	GURRAM MANI RUPAK
12	17E31A0517	HUSNA HIBA
13	17E31A0519	JANUMPALLY GAYATHRI REDDY
14	17E31A0520	KANKATI ARAVIND
15	17E31A0521	KASULA VISHAKA
16	17E31A0522	KONGARI CHANDANA
17	17E31A0523	KOPPULA ANUSHRI
18	17E31A0525	KURA AKHILESH
19	17E31A0526	L ANIKETH SINGH

K. Anil

PRINCIPAL
MAHAVEER
INSTITUTE OF SCIENCE & TECHNOLOGY
Bandlaguda, Hyd-500 005.

Vysapuri, Bandlaguda Post:Keshavgi.

Hyderabad-500 005, TELANGANA INDIA
Tel: 040-64596979,8978380692 Fax: 040-24455003
E-mail: g3hod.cse@gmail.com
Website: www.mist.ac.in,

MAHAVEER

INSTITUTE OF SCIENCE & TECHNOLOGY
Approved by AICTE, Affiliated to JNTUH,Hyd.



DEPARTMENT OF COMPUTER SCIENCE AND ENGINEERING

20	17E31A0528	LONE HARISH
21	17E31A0530	MADDI MAIBU
22	17E31A0532	MANDAPURAM VINITHA
23	17E31A0533	MD ISMAIL
24	17E31A0537	PEDDOLLA ANAND REDDY
25	17E31A0539	RAGULA REKHA
26	17E31A0540	RUQSAR RIYAZ
27	17E31A0541	SARIKELLA MANASA
28	17E31A0542	SHAIK BHASHA
29	17E31A0543	SYED KHALID ABDULLAH
30	17E31A0544	TANGUTOORI SRIKANTH
31	16E31A0504	ANKAM VINEETHA
32	16E31A0505	AVULA VAISHNAVI
33	16E31A0506	BADAM ABILASH
34	16E31A0508	BIJJUR VISHANTH REDDY
35	16E31A0512	GOPIREDDY ANKITH REDDY
36	16E31A0517	MOHD NAVEED AHMED
37	16E31A0522	M NIHARIKA
38	16E31A0524	MALGONDA POOJA
39	16E31A0525	MALKANNAGARI SRUJAY REDDY
40	16E31A0526	MANCHIKANTI SOUMYA

K. Srinivas

PRINCIPAL

MAHAVEER

INSTITUTE OF SCIENCE & TECHNOLOGY
Bandlaguda, Hyderabad-500 005

Vysapuri, Bandlaguda Post:Keshavgiri,

MAHAVEER

INSTITUTE OF SCIENCE & TECHNOLOGY

Approved by AICTE, Affiliated to JNTUH, Hyd.



Hyderabad-500 005, TELANGANA INDIA

Tel: 040-64596979,8978380692 Fax: 040-24455003

E-mail: e3hod.cse@gmail.com,

Website: www.mist.ac.in,

DEPARTMENT OF COMPUTER SCIENCE AND ENGINEERING

41	16E31A0592	NANAVATI SWAPNA
42	16E31A0593	NATTI SRILEKHA
43	16E31A0595	PRUDHVI RAJ NELAPATLA
44	16E31A0599	SANTOSH KULKARNI
45	16E31A05A0	SHAIK MUNAIF MAHMOOD
46	16E31A05A1	SHIPRA RANI BARDHAN
47	16E31A05A2	SURAJ SINGH
48	16E31A05A3	SYED FURKHAN MOHIUDDIN SHUTTARI
49	16E31A05A5	THAVITIREDDY SATEESH CHANDRA
50	16E31A05A8	Y AJAY

K. Srinivas

Principal
Mist
Hyderabad

Vysapuri, Bandlaguda Post:Keshavgirl,

MAHAVEER

INSTITUTE OF SCIENCE & TECHNOLOGY

Approved by AICTE, Affiliated to JNTUH,Hyd.



Hyderabad-500 005, TELANGANA INDIA
Tel: 040-64696979,8978380892,Fax: 040-24455003
E-mail: a3hod.cse@gmail.com,
Website: www.mist.ac.in,

DEPARTMENT OF COMPUTER SCIENCE AND ENGINEERING

Angular JS QUESTION PAPER

Duration: 120 Minutes

10 X 2 = 20 Marks

Answer the following all questions. Each question carries 2 marks.

- 1.What is Angular JS?
- 2.What is the syntax of **ForEach** loop? which loop would you use to parse a JSON and why?
- 3.Explain MVC in reference to angular?
- 4.What is two-way binding?
- 5.Can there be two ng-app for a single angular application?
- 6.What is \$scope? ...
- 7.Name a few inbuilt angular filters? ...
- 8.What are custom filters?
9. What are directives in AngularJS?
- 10.What are expressions in AngularJS?

HOD-CSE

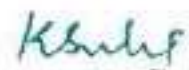



Vysapuri, Bandlaguda Post:Keshavgi,ri,

Hyderabad-500 005, TELANGANA INDIA
Tel: 040-64596979,8979380692.Fax: 040-24455003
E-mail: e3hod.cse@gmail.com
Website: www.mist.ac.in,

MAHAVEER

INSTITUTE OF SCIENCE & TECHNOLOGY

Approved by AICTE. Affiliated to JNTUH,Hyd.



DEPARTMENT OF COMPUTER SCIENCE AND ENGINEERING

RESULT SHEET FOR Angular Js REGISTERED STUDENTS

SNO	HALL TICKET NO	NAME OF THE STUDENT	MARKS (20)	RESULT
1	17E31A0501	A SHIRISHA	20	PASS
2	17E31A0502	BANDARI VARUN KUMAR	19	PASS
3	17E31A0504	BOGEE SUPRIYA	20	PASS
4	17E31A0507	CHEEMALA MAHESH	18	PASS
5	17E31A0508	CHELLOJU ANUSHA	20	PASS
6	17E31A0509	CHENCHU HARISH	20	PASS
7	17E31A0510	D GANESH	16	PASS
8	17E31A0512	G.HARIKA	20	PASS
9	17E31A0514	GANECHARY SHREYA	20	PASS
10	17E31A0515	GEETHIKA C	17	PASS
11	17E31A0516	GURRAM MANI RUPAK	20	PASS
12	17E31A0517	HUSNA HIBA	20	PASS
13	17E31A0519	JANUMPALLY GAYATHRI REDDY	16	PASS
14	17E31A0520	KANKATI ARAVIND	20	PASS
15	17E31A0521	KASULA VISHAKA	20	PASS
16	17E31A0522	KONGARI CHANDANA	18	PASS
17	17E31A0523	KOPPULA ANUSHRI	20	PASS
18	17E31A0525	KURA AKHILESH	19	PASS

K. Srinivas
PRINCIPAL
MAHAVEER
INSTITUTE OF SCIENCE & TECHNOLOGY
HYD-500 005

Vysapuri, Bandlaguda Post:Koshavgirl,

Hyderabad-500 005, TELANGANA INDIA
Tel: 040-64596979,8978380692,Fax: 040-24455003
E-mail: e3hod.cse@gmail.com,
Website: www.miet.ac.in,

MAHAVEER

INSTITUTE OF SCIENCE & TECHNOLOGY

Approved by AICTE. Affiliated to JNTUH,Hyd.



DEPARTMENT OF COMPUTER SCIENCE AND ENGINEERING

19	17E31A0526	L ANIKETH SINGH	20	PASS
20	17E31A0528	LONE HARISH	18	PASS
21	17E31A0530	MADDI MAIBU	20	PASS
22	17E31A0532	MANDAPURAM VINITHA	20	PASS
23	17E31A0533	MD ISMAIL	16	PASS
24	17E31A0537	PEDDOLLA ANAND REDDY	20	PASS
25	17E31A0539	RAGULA REKHA	19	PASS
26	17E31A0540	RUQSAR RIYAZ	20	PASS
27	17E31A0541	SARIKELLA MANASA	18	PASS
28	17E31A0542	SHAIK BHASHA	20	PASS
29	17E31A0543	SYED KHALID ABDULLAH	20	PASS
30	17E31A0544	TANGUTOORI SRIKANTH	16	PASS
31	16E31A0504	ANKAM VINEETHA	20	PASS
32	16E31A0505	AVULA VAISHNAVI	20	PASS
33	16E31A0506	BADAM ABILASH	17	PASS
34	16E31A0508	BIJJUR VISHANTH REDDY	20	PASS
35	16E31A0512	GOPIREDDY ANKITH REDDY	20	PASS
36	16E31A0517	MOHD NAVEED AHMED	16	PASS
37	16E31A0522	M NIHARIKA	20	PASS
38	16E31A0524	MALGONDA POOJA	20	PASS
39	16E31A0525	MALKANNAGARI SRUJAY	18	PASS

Principal

MAHAVEER
INSTITUTE OF SCIENCE & TECHNOLOGY
Bandlaguda, Hyd-500 005.

Vysapuri, Bandlaguda Post:Keshavgiri,

Hyderabad-500 005, TELANGANA INDIA
Tel: 040-64596979,8978380692,Fax: 040-24455003
E-mail: e3hod.cse@gmail.com,
Website: www.mist.ac.in,

MAHAVEER

INSTITUTE OF SCIENCE & TECHNOLOGY

Approved by AICTE, Affiliated to JNTUH,Hyd.



DEPARTMENT OF COMPUTER SCIENCE AND ENGINEERING

		REDDY		
40	16E31A0526	MANCHIKANTI SOUMYA	20	PASS
41	16E31A0592	NANAVATH SWAPNA	19	PASS
42	16E31A0593	NATTI SRILEKHA	20	PASS
43	16E31A0595	PRUDHVI RAJ NELAPATLA	18	PASS
44	16E31A0599	SANTOSH KULKARNI	20	PASS
45	16E31A05A0	SHAIK MUNAIF MAHMOOD	20	PASS
46	16E31A05A1	SHIPRA RANI BARDHAN	16	PASS
47	16E31A05A2	SURAJ SINGH	20	PASS
48	16E31A05A3	SYED FURKHAN MOHIUDDIN SHUTTARI	20	PASS
49	16E31A05A5	THAVITIREDDY SATEESH CHANDRA	20	PASS
50	16E31A05A8	Y AJAY	18	PASS

No. of students Registered:50

No. of students Passed:50

No. of students failed:NIL

K. Srinivas

20/11/2016
16E31A05A8
16E31A05A5
16E31A05A2

Vysapuri, Bandlaguda Post Keshavnagar,

MAHAVEER



Hyderabad-500 005, TELANGANA INDIA
Tel: 040-64596979, 8978380692 Fax: 040-24455003
E-mail: e3hod,use@mist.ac.in
Website: www.mist.ac.in

Approved by M.C.T.E., Affiliated to JNTU Hyderabad

DEPARTMENT OF COMPUTER SCIENCE AND ENGINEERING

SUMMARY REPORT OF Angular JS

- AngularJS is a efficient framework that can create Rich Internet Applications (RIA).
- AngularJS provides developers an options to write client side applications using javascript in a clean Model View Controller (MVC) way.
- Applications written in AngularJS are cross-browser compliant.

COORDINATOR

Copy to:

1. Department Notice Board
2. Principal for Information
3. Committee Members (Academic)

K. Suresh

PRINCIPAL
MAHAVEER
INSTITUTE OF TECHNOLOGY AND ENGINEERING
BANDLAGUDA POST, HYD-500 005

Vysapuri, Bandlaguda Post:Keshavgiri.

Hyderabad-500 005, TELANGANA INDIA
Tel: 040-64596979,8978380692 Fax: 040-24455003
E-mail: e3hod.it@gmail.com
Website: www.mist.ac.in.

MAHAVEER
INSTITUTE OF SCIENCE & TECHNOLOGY
Approved by AICTE, Affiliated to JNTUH,Hyd.



DEPARTMENT OF INFORMATION TECHNOLOGY

Date:01-09-2018

To,

The principal,
MIST,
Hyderabad.

Sub: Proposal for Add-on Course-Reg.

Dear Sir,

We are going to conduct two weeks workshop on **Web application development using PHP & XML**. We require your approval to go head for further proceeding and hope to get an opportunity to serve you the best .

With thanks and Regards

Dr.A.Neel Gopal Reddy
HOD, Dept of Information Technology
Mahaveer Institute of Science & Technology
Vysapuri, Bandlaguda Post, Keshavgiri
Hyderabad-500005.

Kanhu
Principal
MAHAVEER
INSTITUTE OF SCIENCE & TECHNOLOGY
Vysapuri, Bandlaguda Post, Keshavgiri
Hyderabad-500005

Vysapuri, Bandlaguda Post:Keshavgirl,

Hyderabad-500 005, TELANGANA INDIA
Tel: 040-64596979,8978380692.Fax: 040-24455003
E-mail: e3hod_it@gmail.com,
Website: www.mist.ac.in,

MAHAVEER
INSTITUTE OF SCIENCE & TECHNOLOGY
Approved by AICTE. Affiliated to JNTUH,Hyd.



DEPARTMENT OF INFORMATION TECHNOLOGY

Date: 03-09-2018

CIRCULAR

Technical Trainings for III & IV B. Tech students are starting from 10-09-2018 onwards. All HODs and placements coordinators have to manage the trainings and ensure 95% attendance all through the sessions.

All mentors need to send the compiled feedback report to HOD at e3hod_it@gmail.com daily. Mentors are advised to take care of PNR (Students not participating in training).

Agenda: Web application development using PHP & XML.

Design and Development of Curriculum for Add on Course:

Name of the Faculty: 1.Dr. CH B NAGA LAKSHMI
2.S.SRINIVAS
3.B.MALLAIAH

[Handwritten Signature]
HOD

[Handwritten Signature]
PRINCIPAL
MAHAVEER
INSTITUTE OF SCIENCE & TECHNOLOGY
Bandlaguda, Hyderabad-500 005

Head of Department
Department of Information Technology
Mahaveer Institute of Science & Technology
Bandlaguda, Hyderabad-500 005

Vysapuri, Bandlaguda Post:Keshavgiri,

MAHAVEER

INSTITUTE OF SCIENCE & TECHNOLOGY

Approved by AICTE, Affiliated to JNTUH,Hyd.



Hyderabad-500 005, TELANGANA INDIA

Tel: 040-84596979,8978380692.Fax: 040-24455003

E-mail: s3hod.it@gmail.com.

Website: www.mist.ac.in.

DEPARTMENT OF INFORMATION TECHNOLOGY

LIST OF REGISTERED STUDENTS FOR Web application development using PHP & XML

SNO	HALL TICKET NO	NAME OF THE STUDENT
1	15E31A1202	AMAN SINGH BADYAL
2	15E31A1203	ARUTLA RAJ GOPAL
3	15E31A1204	BALLA UPENDRA
4	15E31A1205	BALMOORI SAHITHI
5	15E31A1206	CHATLA NIKHIL KUMAR
6	15E31A1207	D KRISHNA SRI
7	15E31A1208	D LAXMI SAROJA
8	15E31A1209	DOBAGARI NIKHITHA
9	15E31A1210	DUMALA VENU
10	15E31A1211	GANDHASIRI BHARATHI KUMAR
11	15E31A1212	GUNNALA SIRISHA
12	15E31A1213	K RASHMITHA
13	15E31A1214	KALIGOTA VIGNESH REDDY
14	15E31A1215	KAPARTHI SRIVARDHAN
15	15E31A1216	KARKONI NILESH
16	15E31A1217	KATAM PRIYANKA
17	15E31A1218	KATHROJU ASHOK
18	15E31A1219	KOLANU GREESHIMA REDDY
19	15E31A1220	KONIDENA SAI VARSHITHA
20	15E31A1221	KOTLA VISWASRI
21	15E31A1222	KURUKUNTLA HARISH SAGAR
22	15E31A1223	KUSUMA SAI VAMSHI ADITYA
23	15E31A1224	M BHAGYA LAXMI
24	15E31A1225	MITTAKANTI ANUSHA
25	15E31A1228	PINGALI SINDHU
26	15E31A1229	POSHETTY MANISHA
27	15E31A1231	SRIPEEDAMBU DUR SEENIVAS SWAMY
28	15E31A1232	TUNIKI SHIVAKUMAR
29	15E31A1233	VILASAGARAM DEVENDAR
30	15E31A1235	YETHONDA NARAIHARIKRISHNA
31	14E31A1213	K AKSHAY REDDY
32	16E31A1202	ADURLA PAVAN
33	16E31A1203	AKULA PRANATHI
34	16E31A1204	ANDE NAVEEN KUMAR
35	16E31A1206	CHENNUPATI CHAITANYA
36	16E31A1207	CHIDIMILLA ASHWIDHI
37	16E31A1208	DEVARANENI SANJAY
38	16E31A1211	GOLI ARUN KUMAR
39	16E31A1212	KARING DINESH
40	16E31A1213	KEERTHI SAI KRISHNA
41	16E31A1214	KURUVA VAISHNAVI

Keshav
MAHAVEER
INSTITUTE OF SCIENCE & TECHNOLOGY
Bandlaguda Post, Vysapuri, Keshavnagar, Hyderabad-500005

Vysapuri, Bandlaguda Post: Keshavgi, Hyderabad-500 005, TELANGANA INDIA

Tel: 040-64596979, 6978380692 Fax: 040-24455003

E-mail: eshod.it@gmail.com,

Website: www.mist.ac.in,

MAHAVEER

INSTITUTE OF SCIENCE & TECHNOLOGY

Approved by AICTE, Affiliated to JNTUH, Hyd.



DEPARTMENT OF INFORMATION TECHNOLOGY

SYLLABUS FOR Web application development using PHP & XML

SNO	TOPIC COVERED	DURATION
1	Introduction to PHP	3
2	Handling Html Form With Php	3
3	Decisions and loop	3
4	Function, String, Arrays	3
5	Working with file and Directories	3
6	String matching with regular expression	3
7	Generating Images with PHP	3
8	Database Connectivity with MySql	3
9	XML-tags, elements, attributes	3
10	XML-validations	3
11	XML-DTDs	3
12	XML-Schemas	3
13	XML-Databases	3

[Handwritten Signature]
HOD-IT

[Handwritten Signature]
PRINCIPAL
MAHAVEER
INSTITUTE OF SCIENCE & TECHNOLOGY
Bandlaguda, Hyd-500 005

Vysapuri, Bandlaguda Post, Keshavnagar,

MAHAVEER

INSTITUTE OF SCIENCE & TECHNOLOGY

Approved by AICTE, Affiliated to JNTUH, Hyd



Hyderabad-500 005, TELANGANA INDIA

Tel: 040-84596979, 8978380692, Fax: 040-24455003

E-mail: e3hod.it@gmail.com

Website: www.mist.ac.in

DEPARTMENT OF INFORMATION TECHNOLOGY

42	16E31A1217	NANDIKANTI TEJASWINI
43	16E31A1218	PADMA NAVIKANTH CHARY
44	16E31A1219	BABATI SHILPA REDDY
45	16E31A1220	PEDDISSETTY NAGA ANUSHA
46	16E31A1221	PERUMALLA KRANTHI KUMAR
47	16E31A1223	R VAISHNAVI
48	16E31A1224	SAMIEN SULTANA
49	16E31A1225	SRIDHARA GAYATHRI
50	16E31A1227	THADIPARTHI TEJASWINI
51	16E31A1228	VADHADIYA SRINA
52	16E31A1229	VATTIRUJI MAHESH
53	16E31A1230	VITTEDI PAVAN REDDY
54	16E31A1231	YASA ABHINAYA

Head of Department

Department of Information Technology

Mahaveer Institute of Science & Technology

Bandlaguda, Hyd-500 005

Kanthy
PRINCIPAL
MAHAVEER
INSTITUTE OF SCIENCE & TECHNOLOGY
Bandlaguda, Hyd-500 005.

Vysapur, Bandlaguda Post:Keshavnagar,

Hyderabad-500 005, TELANGANA INDIA
Tel: 040-64596979,8978388692 Fax: 040-24455003
E-mail: alhod.it@gmail.com,
Website: www.mist.ac.in,

MAHAVEER

INSTITUTE OF SCIENCE & TECHNOLOGY
Approved by AICTE, Affiliated to JNTUH,Hyd.



DEPARTMENT OF INFORMATION TECHNOLOGY

Web application development using PHP & XML QUESTION PAPER

Duration: 120 Minutes

10 X 2 = 20 Marks

Answer the following all questions. Each question carries 2 marks.

1. What is PHP?
2. Explain the difference b/w static and dynamic websites?
3. What is the difference between "echo" and "print" in PHP?
4. How many data types are there in PHP?
5. What are the different loops in PHP?
6. How can we create a database using PHP and MySQL?
7. How XML is different from HTML?
8. What are the benefits of XML?
9. What is XML DOM and SAX?
10. What is a well formed XML document?

[Handwritten Signature]
D.D-IT

Head of Department
Department of Information Technology
Mahaveer Institute of Science & Technology
Vysapur, Bandlaguda Post, Keshavnagar, Hyderabad-500 005, Telangana

Kanhu
PRINCIPAL
MAHAVEER
INSTITUTE OF SCIENCE & TECHNOLOGY
Bandlaguda, Hyd-500 005.

Vysapuri, Bandlaguda Post:Keshavgiri,

MAHAVEER

INSTITUTE OF SCIENCE & TECHNOLOGY

Approved by AICTE, Affiliated to JNTUH,Hyd.



Hyderabad-500 005, TELANGANA INDIA

Tel: 040-64596979,0978380692, Fax: 040-24455003

E-mail: eshod.it@gmail.com

Website: www.mist.ac.in

DEPARTMENT OF INFORMATION TECHNOLOGY

RESULT SHEET FOR Web application development using PHP & XML REGISTERED STUDENTS

SNO	HALL TICKET NO	NAME OF THE STUDENT	MARKS (20)	RESULT
1	15E31A1202	AMAN SINGH BADYAL	20	PASS
2	15E31A1203	ARUTLA RAJ GOPAL	19	PASS
3	15E31A1204	BALLA UPENDRA	20	PASS
4	15E31A1205	BALMOORI SAHITHI	18	PASS
5	15E31A1206	CHATLA NIKHU, KUMAR	20	PASS
6	15E31A1207	D KRISHNA SRI	20	PASS
7	15E31A1208	D LAXMI SAROJA	16	PASS
8	15E31A1209	DORAGARI NIKHITHA	20	PASS
9	15E31A1210	DUMALA VENU	20	PASS
10	15E31A1211	GANDHASIRI BHARATH KUMAR	17	PASS
11	15E31A1212	GUNNALA SIRISHA	20	PASS
12	15E31A1213	K RASHMITHA	20	PASS
13	15E31A1214	KALIGOTA VIGNESH REDDY	16	PASS
14	15E31A1215	KAPARTHI SRIVARDHAN	20	PASS
15	15E31A1216	KARKONI NILESH	20	PASS
16	15E31A1217	KATAM PRIYANKA	19	PASS
17	15E31A1218	KATHROJU ASHOK	20	PASS
18	15E31A1219	KOLANU GREESHMA REDDY	19	PASS
19	15E31A1220	KONIDENA SAI VARSHITHA	20	PASS
20	15E31A1221	KOTLA VISWASRI	18	PASS
21	15E31A1222	KURUKUNTLA HARISH SAGAR	20	PASS
22	15E31A1223	KUSUMA SAI VAMSHI ADITYA	20	PASS
23	15E31A1224	M BHAGYA LAXMI	16	PASS
24	15E31A1225	MITTAKANTI ANUSHA	20	PASS
25	15E31A1228	PINGALI SINDHU	20	PASS
26	15E31A1229	POSHETTY MANISHA	20	PASS
27	15E31A1231	SRIPEDAMBUDUR SRINIVAS SWAMY	18	PASS
28	15E31A1232	TUNIKI SHIVAKUMAR	19	PASS
29	15E31A1233	VILASAGARAM DEVENDAR	20	PASS
30	15E31A1235	YETHONDA NARAHARIKRISHNA	18	PASS
31	14E31A1215	K AKSHAY REDDY	17	PASS
32	16E31A1202	ADURLA PAVAN	20	PASS
33	16E31A1203	AKULA PRANATHI	19	PASS
34	16E31A1204	ANDE NAVEEN KUMAR	20	PASS
35	16E31A1206	CHENNUPATI CHAITANYA	18	PASS
36	16E31A1207	CHIDIMILLA ASHWIDHI	20	PASS
37	16E31A1208	DEVARANENI SANJAY	20	PASS
38	16E31A1211	GOLI ARUN KUMAR	16	PASS
39	16E31A1212	KARING DINESH	20	PASS

K. Sankar
PRINCIPAL
MAHAVEER
INSTITUTE OF SCIENCE & TECHNOLOGY
Bandlaguda, Hyd-500

Vysapuri, Bandlaguda Post:Keshavgiri,

MAHAVEER

INSTITUTE OF SCIENCE & TECHNOLOGY

Approved by AICTE, Affiliated to JNTUH,Hyd.



Hyderabad-500 005, TELANGANA INDIA

Tel: 040-64596979,8978380692,Fax: 040-24455003

E-mail: e3hod.it@gmail.com,

Website: www.mist.ac.in.

DEPARTMENT OF INFORMATION TECHNOLOGY

40	16E31A1213	KEERTHI SAI KRISHNA	20	PASS
41	16E31A1214	KURUVA VAISHNAVI	17	PASS
42	16E31A1217	NANDIKANTI TEJASWINI	20	PASS
43	16E31A1218	PADALA NAVIKANTH CHARY	20	PASS
44	16E31A1219	PAIPATI SHILPA REDDY	16	PASS
45	16E31A1220	PEDDISSETTY NAGA ANUSHA	20	PASS
46	16E31A1221	PERUMALLA KRANTHI KUMAR	20	PASS
47	16E31A1223	R VAISHNAVI	18	PASS
48	16E31A1224	SAMREEN SULTANA	20	PASS
49	16E31A1225	SRIDHARA GAYATHRI	19	PASS
50	16E31A1227	TILADPARTHI THEJASWINI	20	PASS
51	16E31A1228	VADRADIYA SRINA	18	PASS
52	16E31A1229	VATTIKUTI MAHESH	20	PASS
53	16E31A1230	VITTEDUPAVAN REDDY	20	PASS
54	16E31A1231	YASA ABHINAYA	16	PASS

No. of students Registered:54

No. of students Passed:54

No. of students failed:NIL

K. S. S.
PRINCIPAL
MAHAVEER
INSTITUTE OF SCIENCE & TECHNOLOGY
Bandlaguda, Hyd-500 005.

Vysapuri, Bandlaguda Post:Keshavgiri,

Hyderabad-500 005, TELANGANA INDIA
Tel: 040-64596979,8978380692.Fax: 040-24455003
E-mail: e3hod.it@gmail.com,
Website: www.mist.ac.in,

MAHAVEER

INSTITUTE OF SCIENCE & TECHNOLOGY

Approved by AICTE, Affiliated to JNTUH,Hyd.



DEPARTMENT OF INFORMATION TECHNOLOGY

SUMMARY REPORT OF Web application development using PHP & XML.

PHP Programming the Languages mostly commonly used for Website and Web Application Development.

PHP is a general purpose, server-side scripting language run a web server that's designed to make dynamic pages and applications.

PHP as a web development option is secure, fast and a reliable that offers lots more advantages to make it accessible to a lot of people.

It is to be given a thought as to what has made PHP Programming as one of the most commonly programming language for the Web industry.

XML allows the flexible development of user-defined document types.

It provides a robust, non-proprietary, persistent, and verifiable file format for the storage and transmission of text and data both on and off the Web, and it removes the more complex options of SGML, making it easy to program for.

[Handwritten Signature]
COORDINATOR

Copy to:

1. Department Notice Board
2. Principal for Information
3. Committee Members (Academic)

[Handwritten Signature]

PRINCIPAL
MAHAVEER
INSTITUTE OF SCIENCE & TECHNOLOGY
Bandlaguda, Hyderabad-500 005.

MAHAVEER INSTITUTE OF SCIENCE & TECHNOLOGY
DEPARTMENT OF INFORMATION TECHNOLOGY

With Application Development using PHP & XML ATTENDANCE SHEET

SNO	HALL TICKET	NAME OF THE STUDENT	Date	W	T	F	12	13	14	15	16	17	18	19	20	21	22	23	24	25	26	27	28	
1	15E31A1202	AMAN SINGH BADYAI		P	P	P	P	P	P	P	P	P	P	P	P	P	P	P	P	P	P	P	P	P
2	15E31A1203	ARUTLA RAJ GOPAL		P	P	P	P	P	P	P	P	P	P	P	P	P	P	P	P	P	P	P	P	P
3	15E31A1204	BALLA UPENDRA		P	P	P	P	P	P	P	P	P	P	P	P	P	P	P	P	P	P	P	P	P
4	15E31A1205	BALMOORI SAHITHI		P	P	P	P	P	P	P	P	P	P	P	P	P	P	P	P	P	P	P	P	P
5	15E31A1206	CHATLA NIKHIL KUMAR		P	P	P	P	P	P	P	P	P	P	P	P	P	P	P	P	P	P	P	P	P
6	15E31A1207	D KRISHNA SRI		P	P	P	P	P	P	P	P	P	P	P	P	P	P	P	P	P	P	P	P	P
7	15E31A1208	D LAXMI SAROJA		P	P	P	P	P	P	P	P	P	P	P	P	P	P	P	P	P	P	P	P	P
8	15E31A1209	DORAGARI NIKHITHA		P	P	P	P	P	P	P	P	P	P	P	P	P	P	P	P	P	P	P	P	P
9	15E31A1210	DUMALA VENU		P	P	P	P	P	P	P	P	P	P	P	P	P	P	P	P	P	P	P	P	P
10	15E31A1211	GANDHASIRI BHARATHI KUMAR		P	P	P	P	P	P	P	P	P	P	P	P	P	P	P	P	P	P	P	P	P
11	15E31A1212	GUNNALA SIRISHA		P	P	P	P	P	P	P	P	P	P	P	P	P	P	P	P	P	P	P	P	P
12	15E31A1213	K RASHMITHA		P	P	P	P	P	P	P	P	P	P	P	P	P	P	P	P	P	P	P	P	P
13	15E31A1214	KALIGOTA VIGNESH JEEDY		P	P	P	P	P	P	P	P	P	P	P	P	P	P	P	P	P	P	P	P	P
14	15E31A1215	KAPARTHI SRIVARDHAN		P	P	P	P	P	P	P	P	P	P	P	P	P	P	P	P	P	P	P	P	P
15	15E31A1216	KARKONI NILESH		P	P	P	P	P	P	P	P	P	P	P	P	P	P	P	P	P	P	P	P	P
16	15E31A1217	KATAM PRIYANKA		P	P	P	P	P	P	P	P	P	P	P	P	P	P	P	P	P	P	P	P	P
17	15E31A1218	KATHROJU ANHOK		P	P	P	P	P	P	P	P	P	P	P	P	P	P	P	P	P	P	P	P	P
18	15E31A1219	KOLANU GRESHMA REDDY		P	P	P	P	P	P	P	P	P	P	P	P	P	P	P	P	P	P	P	P	P
19	15E31A1220	KONIDENA SAI VARSHITHA		P	P	P	P	P	P	P	P	P	P	P	P	P	P	P	P	P	P	P	P	P
20	15E31A1221	KOTLA VISWASRI		P	P	P	P	P	P	P	P	P	P	P	P	P	P	P	P	P	P	P	P	P
21	15E31A1222	KURUKUNTLA HARISH SAGAR		P	P	P	P	P	P	P	P	P	P	P	P	P	P	P	P	P	P	P	P	P
22	15E31A1223	KUSUMA SAI VARSHITHA		P	P	P	P	P	P	P	P	P	P	P	P	P	P	P	P	P	P	P	P	P
23	15E31A1224	M BHAGYA LAXMI		P	P	P	P	P	P	P	P	P	P	P	P	P	P	P	P	P	P	P	P	P
24	15E31A1225	MITTAKANTI ANUSHA		P	P	P	P	P	P	P	P	P	P	P	P	P	P	P	P	P	P	P	P	P
25	15E31A1228	PINGALI SINDHU		P	P	P	P	P	P	P	P	P	P	P	P	P	P	P	P	P	P	P	P	P
26	15E31A1229	PONHETTY MANISHA		P	P	P	P	P	P	P	P	P	P	P	P	P	P	P	P	P	P	P	P	P
27	15E31A1231	SRI PEDDAMBUDUR SRINIVAS SWAMY		P	P	P	P	P	P	P	P	P	P	P	P	P	P	P	P	P	P	P	P	P
28	15E31A1232	TU SRI SHIVAKUMAR		P	P	P	P	P	P	P	P	P	P	P	P	P	P	P	P	P	P	P	P	P

Kanthy
Principal
MAHAVEER
INSTITUTE OF SCIENCE & TECHNOLOGY



MAHARAJA INSTITUTE OF SCIENCE & TECHNOLOGY



Approved by AICTE, Affiliated to JNTU, Hyderabad.
Ayanapur, Bandlaguda, Post: Keshavnagar, Hyderabad - 500 003

DEPARTMENT OF INFORMATION TECHNOLOGY

CERTIFICATE

This is to certify that **DEVARANENI SANJAY** bearing Hall Ticket No **16E31A1208** of **B.Tech Third Year** has participated in **Web application development using PHP & XML** training Program From **10-09-2018** to **22-09-2018** organized by **Dept. of INFORMATION TECHNOLOGY.**

[Signature]
Dr. Nanda Gopal Reddy
HOD

[Signature]
Pooja Bhatia
Director/Webtek Labs, Pvt. Ltd.

[Signature]
Dr. K. S. S. N. Reddy
PRINCIPAL.

[Handwritten signature]
Dr. Nanda Gopal Reddy
HOD

Vysapuri, Bandlaguda Post:Keshavgiri,

Hyderabad-500 005, TELANGANA INDIA

Tel: 040-84596979,8978380692 Fax: 040-24455003

E-mail: e3hod.it@gmail.com

Website: www.mist.ac.in

MAHAVEER

INSTITUTE OF SCIENCE & TECHNOLOGY

Approved by AICTE, Affiliated to JNTUH, Hyd.



DEPARTMENT OF INFORMATION TECHNOLOGY

Date: 01-02-2019

To,

The principal,
MIST,
Hyderabad.

Sub: Proposal for Add-on Course-Reg.

Dear Sir,

We are going to conduct two weeks workshop on Technical Training HTML. We require your approval to go head for further proceeding and hope to get an opportunity to serve you the best.

With thanks and Regards

[Handwritten Signature]
HOD

[Handwritten Signature]

PRINCIPAL
MAHAVEER
INSTITUTE OF SCIENCE & TECHNOLOGY
Bandlaguda, Hyd-500 005.

Jysapuri, Bandlaguda Post:Keshavgiri,

Hyderabad-500 005, TELANGANA INDIA
Tel: 040-64596979,8978380692 Fax: 040-24455003
E-mail: e3hod.it@gmail.com
Website: www.mist.ac.in

MAHAVEER

INSTITUTE OF SCIENCE & TECHNOLOGY

Approved by AICTE, Affiliated to JNTUH,Hyd.



DEPARTMENT OF INFORMATION TECHNOLOGY

Date: 04-02-2019

CIRCULAR

Technical Trainings for II & IV B. Tech students are starting from 21-02-2019 onwards. All HODs and placements coordinators have to manage the trainings and ensure 95% attendance all through the sessions.

All mentors need to send the compiled feedback report to HOD at e3hod@gmail.com daily. Mentors are advised to take care of PNR (Students not participating in training).

Agenda: Technical Training HTML.

Design and Development of Curriculum for Add on Course:

Name of the Faculty: 1.Dr.A.NANDA GOPAL REDDY
2.K.B.V.K NAGA SREE
3.V.NARESH KUMAR REDDY

Dr. A. Nanda Gopal Reddy
HOD, Dept. of Information Technology
Mahaveer Institute of Science & Technology
Jysapuri, Bandlaguda, Post Keshavgiri
Hyd-500 005.

MAHAVEER
INSTITUTE OF SCIENCE & TECHNOLOGY
Bandlaguda, Hyd-500 005



DEPARTMENT OF INFORMATION TECHNOLOGY

SYLLABUS FOR Technical Training HTML

SNO	TOPIC COVERED	DURATION
1	Web Programming Introduction	3
2	HTML-Introduction	3
3	HTML-Basic Formatting Tags	3
4	HTML-Grouping Using Div Span	3
5	HTML-Lists	3
6	HTML-Images	3
7	HTML-Hyperlink	3
8	HTML-Table	3
9	HTML-Form	3
10	HTML-Frames	3
11	HTML-Headers	3
12	CSS	3

[Handwritten Signature]
HOD-IT

Dr.A.Nanda Gopal Reddy
HOD, Dept. of Information Technology
Mahaveer Institute of Science & Technology
Vysapuri, Bandlaguda, Post Keshavgiri
Hyderabad-500005

PRINCIPAL
[Handwritten Signature]
MAHAVEER
INSTITUTE OF SCIENCE & TECHNOLOGY
Bandlaguda, Hyd-500 005



MAHAVEER

INSTITUTE OF SCIENCE & TECHNOLOGY

Approved by AICTE, Affiliated to JNTU.Hydr.

Vysapur, Bandlaguda Post, Keshavnagar,

Hyderabad-500 005, TELANGANA INDIA

Tel: 040-64596979, 6978380692 Fax: 040-24455003

E-mail: eshadli@gmail.com

Website: www.mist.ac.in

DEPARTMENT OF INFORMATION TECHNOLOGY

LIST OF REGISTERED STUDENTS FOR Technical Training HTMII

SNO	HALE TICKET NO	NAME OF THE STUDENT
1	15E31A1202	ANAN SINGH BADAVAL
2	15E31A1203	ARJUN RAO GOPAL
3	15E31A1204	BALAJI UPENDRA
4	15E31A1205	BALMOORI SAHITHI
5	15E31A1206	CHAITA NIKHIL KUMAR
6	15E31A1207	D KRISHNA SRI
7	15E31A1208	D LAXMI SAROJA
8	15E31A1209	DORAGARI NIKHITHA
9	15E31A1210	DUMALA VENU
10	15E31A1211	GANDHASIRI BHARATH KUMAR
11	15E31A1212	GUNNALA SRISHA
12	15E31A1213	K RASHMITHA
13	15E31A1214	KALIGOTA VIGNESH REDDY
14	15E31A1215	KAPARTH SRIVARDHAN
15	15E31A1216	KARAKONI NILESH
16	15E31A1217	KATAM PRAYANKA
17	15E31A1218	KATHROTI ASHOK
18	15E31A1219	KOLANU GRESHMA REDDY
19	15E31A1220	KONDENA SAI VARSHITHA
20	15E31A1221	KOTLA VISWASRI
21	15E31A1222	KURUKUNTA HARISH SAGAR
22	15E31A1223	KUSUMIA SAI VANISHI ADITYA
23	15E31A1224	M BHAGYA LAXMI
24	15E31A1225	MITTAKANTI ANUSHA
25	15E31A1228	PINGALI SINDHU
26	15E31A1229	POSHETTY MANISHA
27	15E31A1231	SURESHWAR DILIP SRINIVAS SWAMY
28	15E31A1232	TUNDI SHIVAKUMAR
29	15E31A1233	VILASAGARANI DEVENDAR
30	15E31A1235	YETHONDA NARAHARIKRISHNA
31	14E31A1213	K AKSHAY REDDY
32	17E31A1201	AKULA SAI JAHNAVI
33	17E31A1203	BAINGAR HARI PRASAD
34	17E31A1205	BHARADWAJ AJITH
35	17E31A1206	BOLLA KIRAN KUMAR
36	17E31A1207	C PRASHANSHA
37	17E31A1208	CEELA MAHESH
38	17E31A1209	GANDHAM SHYAMALA
39	17E31A1210	KAHAVI VINETHA
40	17E31A1211	KAKANI HIMA BINDU
41	17E31A1212	KANDUKURI VINITHA

Hyderabad, 496-500 005
 VEEER
 Institute of Science & Technology
 Vysapur, Bandlaguda Post, Keshavnagar, Hyderabad-500 005, TELANGANA INDIA

Vysapuri, Bandlaguda Post, Keshavnagar,

Hyderabad-500 005, TELANGANA INDIA
Tel: 040-64596979,8978380692.Fax: 040-24455003
E-mail: e3hod.it@gmail.com.
Website: www.mist.ac.in,

MAHAVEER

INSTITUTE OF SCIENCE & TECHNOLOGY

Approved by AICTE, Affiliated to JNTUH,Hyd.



DEPARTMENT OF INFORMATION TECHNOLOGY

42	17E31A1213	LAKSHIKA PAREEK
43	17E31A1214	LOKA SAMBITHA
44	17E31A1215	MADHURETTY BHAVYA SRI
45	17E31A1217	MARAM AKSHITHA
46	17E31A1218	MEKA SRIRISINDA
47	17E31A1219	MIRYALA SRINIKHA
48	17E31A1220	MOHAMMED ABDEL RAZZAK
49	17E31A1221	MOHAMMED FARAD
50	17E31A1222	MOHD HUSSAIN UDDIN
51	17E31A1223	MOHD MOIN UDDIN SIDDIQUI
52	17E31A1227	PATHA SAIKIRAN
53	17E31A1229	RAVULLA PRANEETH
54	17E31A1230	SAMIA NAVYA
55	17E31A1231	TUSIMA NISHANTH KUMAR
56	17E31A1232	VIDHYADAR SHARMA P
57	17E31A1233	YASMEEN BEGUM
58	16E31A1215	MOHD SALMAN

[Handwritten signature]

Vysapuri, Bandlaguda Post, Keshavnagar,
Hyderabad-500005.

[Handwritten signature]
PRINCIPAL
MAHAVEER
INSTITUTE OF SCIENCE & TECHNOLOGY
Bandlaguda, Hyd-500 005.

Vysapuri, Bandlaguda Post:Keshavgiri,

Hyderabad-500 005, TELANGANA INDIA
Tel: 040-64596979,8978380692, Fax: 040-24455003
E-mail: e3hod.it@gmail.com,
Website: www.mist.ac.in,

MAHAVEER

INSTITUTE OF SCIENCE & TECHNOLOGY

Approved by AICTE, Affiliated to JNTUH,Hyd.



DEPARTMENT OF INFORMATION TECHNOLOGY

Technical Training HTML QUESTION PAPER

Duration: 120 Minutes

10 X 2 = 20 Marks

Answer the following all questions. Each question carries 2 marks.

- 1) What is HTML?
- 2) What are Tags?
- 3) How many types of heading does an HTML contain?
- 4) How to create a hyperlink in HTML?
- 5) Which HTML tag is used to display the data in the tabular form?
- 6) What are some common lists that are used when designing a page?
- 7) How to insert a copyright symbol on a browser page?
- 8) What is a style sheet?
- 9) What is a marquee?
- 10) How to make a picture of a background image of a web page?

Dr. A. Nanda Gopal Reddy
HOD, Dept of Information Technology
Mahaveer Institute of Science & Technology
Vysapuri, Bandlaguda Post, Keshavgiri,
Hyderabad-500 005

Keshavgiri
PRINCIPAL
MAHAVEER
INSTITUTE OF SCIENCE & TECHNOLOGY
Bandlaguda Post, Hyderabad-500 005

Kysapuri, Bandlaguda Post, Keshavgi,

Hyderabad-500 005, TELANGANA INDIA
Tel: 040-64596979, 8978380692, Fax: 040-24458003
E-mail: g3hod.it@gmail.com,
Website: www.mist.ac.in,

MAHAVEER

INSTITUTE OF SCIENCE & TECHNOLOGY
Approved by AICTE, Affiliated to JNTU(H)Hyd.



DEPARTMENT OF INFORMATION TECHNOLOGY

RESULT SHEET FOR Technical Training HTML REGISTERED STUDENTS

SNO	HALL TICKET NO	NAME OF THE STUDENT	MARKS (09)	RESULT
1	15E31A1202	AMAN SINGH BADYAL	20	PASS
2	15E31A1203	ARUTLA RAJ GOPAL	19	PASS
3	15E31A1204	BALLA UPENDRA	20	PASS
4	15E31A1205	HAL MOGRI SAHITHI	11	PASS
5	15E31A1206	CHAITLA NIKHIL KUMAR	20	PASS
6	15E31A1207	G KRISHNA SRI	20	PASS
7	15E31A1208	D LAXMI SAROJA	16	PASS
8	15E31A1209	DORAGARI NIKHITIA	20	PASS
9	15E31A1210	DUMALA VENU	20	PASS
10	15E31A1211	GANDRASRI BHARATH KUMAR	17	PASS
11	15E31A1212	GUNNALA SIRISHA	20	PASS
12	15E31A1213	K RASHMITHA	20	PASS
13	15E31A1214	KALIGOTA VIGNESH REDDY	16	PASS
14	15E31A1215	KAPARTHI SRIVARDHAN	20	PASS
15	15E31A1216	KARIKONI NILESH	20	PASS
16	15E31A1217	KATAM PRIYANKA	20	PASS
17	15E31A1218	KATHROJU ASHOK	19	PASS
18	15E31A1219	KOLANI GRESHMA REDDY	20	PASS
19	15E31A1220	KONIDENA SAI VARSHITHA	18	PASS
20	15E31A1221	KOTLA VISWASRI	20	PASS
21	15E31A1222	KURUKUNTLA HARISH SAGAR	20	PASS
22	15E31A1223	KUSUMA SAI YAMSHI ADITYA	16	PASS
23	15E31A1224	M BHAGYA LAXMI	20	PASS
24	15E31A1225	MITTAKANTI ANUSHA	20	PASS
25	15E31A1228	PINGALI SENDHU	20	PASS
26	15E31A1229	POSHETTI MANISHA	15	PASS
27	15E31A1231	SRIPEDAMHODUR SRINIVAS SWAMY	19	PASS
28	15E31A1232	TUNIKI SHIVAKUMAR	18	PASS
29	15E31A1233	VILASAGARAM DEVENDAR	17	PASS
30	15E31A1235	YETHONDA NARAIHARIKRISHNA	19	PASS
31	14E31A1213	KAUSHAY REDDY	20	PASS
32	17E31A1201	AKULA SAI JAHNAVI	19	PASS
33	17E31A1203	BAINGAR HARI PICASAD	20	PASS
34	17E31A1205	BHARADWAJ AJITH	18	PASS
35	17E31A1206	BOLLA KIRAN KUMAR	20	PASS
36	17E31A1207	C PRASHANSHA	20	PASS
37	17E31A1208	CEELA MAHESH	16	PASS
38	17E31A1209	GANDHAM SHYAMALA	20	PASS
39	17E31A1210	KAAVATI VINEETHA	20	PASS
40	17E31A1211	KAKANI HIMA BINDU	17	PASS
41	17E31A1212	KANDUKURI VINEETHA		

Handwritten signature and stamp in the bottom right corner.



DEPARTMENT OF INFORMATION TECHNOLOGY

42	17E31A1213	LAKSHIKA PAREEK	20	PASS
43	17E31A1214	LOKA SAMHITHA	20	PASS
44	17E31A1215	MADISHETTY BHAVYA SRI	16	PASS
45	17E31A1217	MARAM AKSHITHA	20	PASS
46	17E31A1218	MEKA SRIKRISHNA	20	PASS
47	17E31A1219	MIRYALA MOUNIKA	18	PASS
48	17E31A1220	MOHAMMED ABDUL RAZZAK	20	PASS
49	17E31A1221	MOHAMMED JAWAD	19	PASS
50	17E31A1222	MOHD HUSSAIN UDDIN	20	PASS
51	17E31A1223	MOHD MOIN UDDIN SIDDIQUI	18	PASS
52	17E31A1227	PATHA SAIKIRAN	20	PASS
53	17E31A1229	RAVUTLA PRANEETH	20	PASS
54	17E31A1230	SAMA NAVYA	16	PASS
55	17E31A1231	TUMMA NISHANTH KUMAR	20	PASS
56	17E31A1232	VIDHYADAR SHARMA P	20	PASS
57	17E31A1233	YASMEEN BEGUM	20	PASS
58	16E31A1235	MOHD SALMAN	18	PASS

No. of students Registered:58

No. of students Passed:58

No. of students failed:NIL

Dr. A. Nanda Anand Reddy
HOD, Dept. of Information Technology
Mahaveer Institute of Science & Technology
Hyderabad, India

Kanika
PRINCIPAL
MAHAVEER
INSTITUTE OF SCIENCE & TECHNOLOGY
Hyderabad, India-500 005

Bandlaguda Post:Keshavgirl,

Hyderabad-500 005, TELANGANA INDIA
Tel: 040-64596979,8978380692 Fax: 040-24455003
E-mail: e3hod.it@gmail.com,
Website: www.mist.ac.in,

MAHAVEER

INSTITUTE OF SCIENCE & TECHNOLOGY

Approved by AICTE, Affiliated to JNTUH Hyd.



DEPARTMENT OF INFORMATION TECHNOLOGY

SUMMARY REPORT OF Technical Training HTML

- Python programming language is considered as simple language as it extracts most of the concepts of C and Java in terms of syntax.
- Python programming is used to learn how to design, program the python applications and explains how to use lists, tuples and dictionaries in python programs
- It explains how to identify python objet types to use indexing and slicing to access data and also to define the structure and components of a python program
- It contains the concepts of loops and decision control statements and a parameter passing techniques
- It explains the concepts of packages and to read write into the python file. has beautiful concepts of inheriting a class and ability to handle the exceptions

COORDINATOR

Copy to:

1. Department Notice Board
2. Principal for Information
3. Committee Members (Academic)

PRINCIPAL
MAHAVEER
INSTITUTE OF SCIENCE & TECHNOLOGY
Bandlaguda, Hydr-500 005



ESTD - 2001

MAHAVEER INSTITUTE OF SCIENCE & TECHNOLOGY

Approved by AICTE, Affiliated to JNTU, Hyderabad.

Vyasapur, Bandlaguda, Post: Keshavnigri, Hyderabad - 500 005



DEPARTMENT OF INFORMATION TECHNOLOGY

CERTIFICATE

This is to certify that **C PRASHANSHA** bearing Hall Ticket No **17E31A1207** of **B.Tech Second Year** has participated in **Technical Training on HTML** training Program From **21-02-2019** to **09-03-2019** organized by Dept. of **INFORMATION TECHNOLOGY**.

[Signature]
Dr. K. Prashanth Reddy
HOD.

[Signature]
P. S. Bhatia
Director/Webtek Labs. Pvt. Ltd.

[Signature]
Dr. K. S. S. N. Reddy
PRINCIPAL

ESTD: 2001

PRINCIPAL
Dr. K. S. S. N. Reddy
MAHAVEER INSTITUTE OF SCIENCE & TECHNOLOGY
Vyasapur, Bandlaguda, Post: Keshavnigri, Hyderabad - 500 005

Vysapuri, Bandlaguda Post:Keshavgiri,
Hyderabad-500 005, Telangana INDIA
Tel: 040-64696979,20020773, Fax: 040-24455063
E-mail: principal.mahaveer@gmail.com
Website: www.mist.ac.in

MAHAVEER



Approved by AICTE, Affiliated to JNTUH,Hyd.

DEPARTMENT OF AERONAUTICAL ENGINEERING

PROPOSAL LETTER

Hyderabad,

07/09/2018.

To,
The principal,
MIST,
Hyderabad.

Sub: Proposal for two weeks workshop on Computer Aided Design CREO –Reg.

Dear Sir,

We are working as Asst professor in the department of AERONAUTICAL ENGINEERING.
Sir, we are going to conduct three weeks workshop Computer Aided Design CREO. We require your approval to go head for further proceeding and hope to get an opportunity to serve you the best.

With thanks and Regards

From,
AERO Department
Mist,
Bandlaguda,

K. Srinivas
PRINCIPAL
MAHAVEER
INSTITUTE OF SCIENCE AND TECHNOLOGY
BANDLAGUDA, HYDERABAD-500005

A. Prasanna



DEPARTMENT OF AERONAUTICAL ENGINEERING

Date: 13.09.2018

CIRCULAR

Technical Training for II B. Tech students are starting from 13-09-2018 onwards. All HODs and Placements coordinators have to manage the trainings and ensure 95% attendance all through the sessions.

All Mentors need to send the compiled feedback report to A Ranga Reddy, HOD at e3hod.aero@gmail.com daily.

Agenda: Computer Aided Design CREO

Prof RANGA REDDY
HOD

Course Designed By

Y RAGHUVeer

G RAJESH KUMAR

13/09/18
PRINCIPAL
MAHAVEER
INSTITUTE OF TECHNOLOGY
Bandlaguda Post, Keshavnagar, Hyderabad-500 005



SYLLABUS

Course: Computer Aided Analysis CREO

1 : Introduction

- Creo Graphical User Interface
- Feature manager design tree,
- Handles, mouse buttons,
- keyboard shortcuts,
- Understanding the Windows Menu
- Hardware and Software requirements,

2: Sketch Entities

- Inference line, Centerline line, Line, Circle, Arc, Ellipse, Rectangle, Slots, Polygon, Parabola, Ellipse, Partial Ellipse, Spline, Spline tools,
- Spline on surface,
- Equation driven curve, Points, Text,
- Construction geometry, Snap, grid

3: Sketch Tools

- Fillet, Chamfer, Offset, Convert entities, Trim, Extend, Split, Jog, Mirror, Dynamic Mirror, Move, Copy, Rotate, Scale, Stretch, Sketch pattern

4: Part Modeling Tool

- Creating Extrude features – Direction1, Direction2, From option, Thin feature, Applying draft, Selecting contours Creating Revolve features – Selecting Axis, Thin features, Selecting contours Creating Swept features- Selecting, Profile and Path, Orientation/twist type, Path Alignment, Guide Curves, Start/End tangency, Thin feature

Vysapuri, Bandlaguda Post:Keshavgiri,
Hyderabad-500 005, Telangana INDIA
Tel: 040-64596979,20020773, Fax: 040-24455003
E-mail: principal.mahaveer@gmail.com,
Website: www.mist.ac.in,

MAHAVEER

INSTITUTE OF SCIENCE & TECHNOLOGY
Approved by AICTE, Affiliated to JNTUH,Hyd



Computer Aided Design CREO

STUDENT LIST 2018-19

II - II AERO			YEAR
1	17E31A2102	ABHIMANYU N ASHREY	II
2	17E31A2103	ADIRE SPANDANA	II
3	17E31A2105	AYUSHMAN DUBEY	II
4	17E31A2111	GUDISE VINAYKUMAR	II
5	17E31A2112	GUGULOTH SAIKRISHNA	II
6	17E31A2113	KAMIDI SHIVA SAHITHI	II
7	17E31A2114	KARANKOT KEERTHI	II
8	17E31A2116	KUDIKALA ANOSH	II
9	17E31A2118	MANDALA PRADEEP KUMAR	II
10	17E31A2120	MOHAMMAD JUNAID SIDDIQUI	II
11	17E31A2123	NAINI MANISH YADAV	II
12	17E31A2125	POLA ROHITH KUMAR	II
13	17E31A2127	SAMBARU VIKAS	II
14	17E31A2128	SODARI HAPPI	II
15	17E31A2129	SYED ZAID ASADULLAH	II
16	17E31A2131	VAJEER NARENDHAR	II
17	18E35A2102	GUGULOTHU NIKHIL	II
18	18E35A2103	SYED AFZAL	II

Kanthy
PRINCIPAL
MAHAVEER
INSTITUTE OF SCIENCE & TECHNOLOGY
BANDLAGUDA, HYDERABAD

A. Domale
HOD



Technical Training Exam on Computer Aided Design CREOSoftware
(A.Y-2018-19)

2x10=20 Marks

Answer All the Questions

1. Draw the given 2D model into 3D model by using CREO

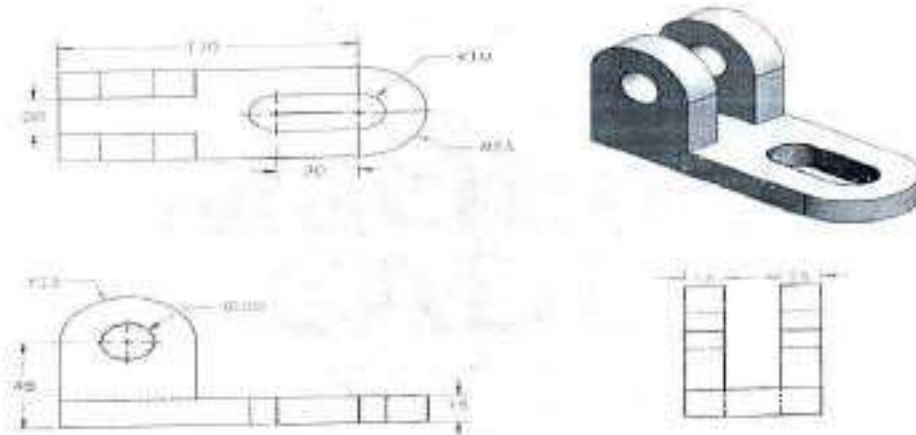

2. Draw the given 2D model into 3D model by using Auto CAD.

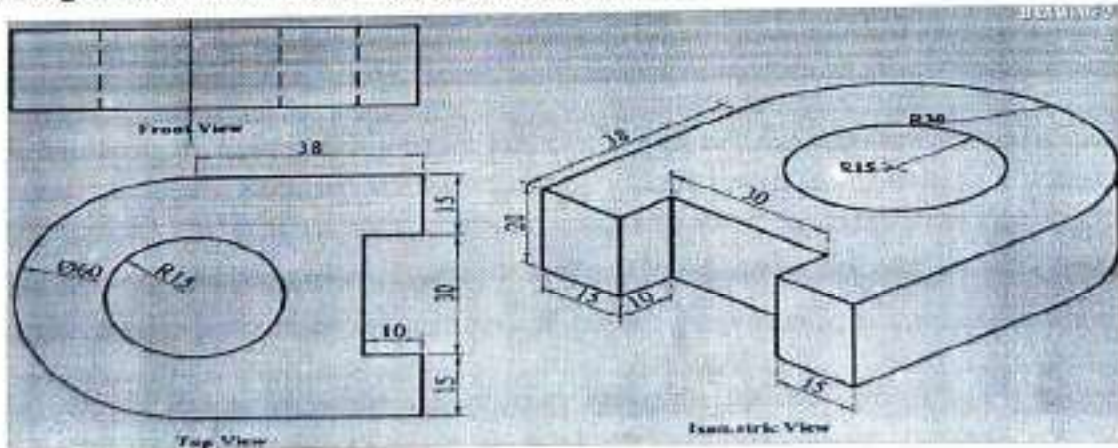

Handwritten signature
PRINCIPAL
MAHAVEER
Institute of Technology and Engineering
Bandlaguda, Hyderabad



Computer Aided Design CREO course

Training student marks list 2018-19

II - II AERO			MARKS	PASS/FAIL
1	17E31A2102	ABHIMANYU N ASHREY	16	PASS
2	17E31A2103	ADIRE SPANDANA	16	PASS
3	17E31A2105	AYUSHMAN DUBEY	19	PASS
4	17E31A2111	GUDISE VINAYKUMAR	19	PASS
5	17E31A2112	GUGULOTH SAIKRISHNA	15	PASS
6	17E31A2113	KAMIDI SHIVA SAHITHI	18	PASS
7	17E31A2114	KARANKOT KEERTHI	17	PASS
8	17E31A2116	KUDIKALA ANOSH	18	PASS
9	17E31A2118	MANDALA PRADEEP KUMAR	19	PASS
10	17E31A2120	MOHAMMAD JUNAID SIDDIQUI	17	PASS
11	17E31A2123	NAINI MANISH YADAV	15	PASS
12	17E31A2125	POLA ROHITH KUMAR	16	PASS
13	17E31A2127	SAMBARU VIKAS	15	PASS
14	17E31A2128	SODARI HAPPY	14	PASS
15	17E31A2129	SYED ZAID ASADULLAH	14	PASS
16	17E31A2131	VAJEER NARENDHAR	16	PASS
17	18E35A2102	GUGULOTHU NIKHIL	15	PASS
18	18E35A2103	SYED AFZAL	17	PASS

Principal
PRINCIPAL
MAHAVEER
INSTITUTE OF TECHNOLOGY
BANDLAGUDA, HYD-500 005

A. Adornalaya
HOD

MAHAVEER INSTITUTE OF SCIENCE AND TECHNOLOGY
AERONAUTICAL ENGINEERING
COURSE ATTENDANCE LIST

S.NO	HT NO	NAME	13	14	15	16	17	18	19	20	21	22	23	24	25	26	27
1	17E31A2302	ABHIMANYU NASHLEY	P	P	P	P	P	P	P	P	P	P	P	P	P	P	P
2	17E31A2303	SADHIL SPANDANA	P	P	P	P	P	P	P	P	P	P	P	P	P	P	P
3	17E31A2305	AVUSHMAN DUBEY	P	P	P	P	P	P	P	P	P	P	P	P	P	P	P
4	17E31A2113	GUDISE VINAYKUMAR	P	P	P	P	P	P	P	P	P	P	P	P	P	P	P
5	17E31A2112	GUJULOTH SAKRISHMA	P	P	P	P	P	P	P	P	P	P	P	P	P	P	P
6	17E31A2113	KAMIDI SHIVA SANITHI	P	P	P	P	P	P	P	P	P	P	P	P	P	P	P
7	17E31A2114	KARANKOT KEERTHI	P	P	P	P	P	P	P	P	P	P	P	P	P	P	P
8	17E31A2116	KUJIKALA ANOSH	P	P	P	P	P	P	P	P	P	P	P	P	P	P	P
9	17E31A2118	MANDALA PRADEEP KUMAR	P	P	P	P	P	P	P	P	P	P	P	P	P	P	P
10	17E31A2120	MOHAMMAD IUNAJD SIDDIQUI	P	P	P	P	P	P	P	P	P	P	P	P	P	P	P
11	17E31A2123	NAINI MANESH YADAV	P	P	P	P	P	P	P	P	P	P	P	P	P	P	P
12	17E31A2125	POLA ROHITH KUMAR	P	P	P	P	P	P	P	P	P	P	P	P	P	P	P
13	17E31A2127	SAMBARU VIKAS	P	P	P	P	P	P	P	P	P	P	P	P	P	P	P
14	17E31A2128	SODARI HANNA	P	P	P	P	P	P	P	P	P	P	P	P	P	P	P
15	17E31A2129	SYED ZAID ASADULLAH	P	P	P	P	P	P	P	P	P	P	P	P	P	P	P
16	17E31A2131	VAREER NARENDHAR	P	P	P	P	P	P	P	P	P	P	P	P	P	P	P
17	18E35A2102	GUJULOTHU NICHOL	P	P	P	P	P	P	P	P	P	P	P	P	P	P	P
18	18E35A2203	SYED RAFAL	P	P	P	P	P	P	P	P	P	P	P	P	P	P	P

Wanted

PROF. CERNAL
 MAHAVEER INSTITUTE OF SCIENCE AND TECHNOLOGY
 Basantapada, Hyd-500046.

A. Dasarathulu
 HOD



Course:Computer Aided Design CREO

Summary report

This course aims to help product designers and engineers in developing a product design virtually. Creo is equipped with all the capabilities that are required for completing a product design. The software Creo provides the broadest range of scalable software solutions towards product development within the market.

With Creo Parametric, and its extensions, you can create, analyze, view, and share designs downstream using 2D CAD, 3D CAD, and parametric and direct modeling capabilities

S. Prasad
HOD

Subj
PRINCIPAL
MAHAVEER
INSTITUTE OF SCIENCE & TECHNOLOGY
Bandlaguda, Hyderabad-500 005

Vysapuri, Bandleguda Post:Keshavgiri,
Hyderabad-500 005, Telangana INDIA
Tel: 040-64596979,20020773, Fax: 040-24455003
E-mail: principal.mahaveer@gmail.com,
Website: www.mist.ac.in.

MAHAVEER

INSTITUTE OF SCIENCE & TECHNOLOGY
Approved by AICTE, Affiliated to JNTUH, Hyd.



CERTIFICATE OF COURSE COMPLETION

This certificate is presented to ADIRE SPANDANA of MIST, who has successfully completed technical training course on “Computer Aided Design CREO” held from 13-09-2018 to 27-09-2018 and found the student performance to be excellent.



A. Ranga Reddy
A RANGA REDDY
HOD (AERO)

K. Sankar
PRINCIPAL
MAHAVEER
INSTITUTE OF SCIENCE & TECHNOLOGY
Bandleguda-10, Hyderabad-500 005.

Vysapuri, Bandlaguda Post:Keshavgiri,

Hyderabad-500 005, TELANGANA INDIA
Tel: 040-64596979,8978380692,Fax: 040-24455003
E-mail: e3hod.it@gmail.com,
Website: www.mist.ac.in,

MAHAVEER
INSTITUTE OF SCIENCE & TECHNOLOGY
Approved by AICTE, Affiliated to JNTUH,Hyd.



DEPARTMENT OF HUMANITIES AND SCIENCES

Date: 25-08-18

To,
The principal,
MIST ,
Hyderabad.

Sub: Proposal for Add-on-course-Reg

Dear sir,

We are going to conduct Add-On course on Communication skills. we require your approval to go head for further proceeding and hope to get an opportunity to serve you the best.

With thanks and Regards

PRINCIPAL
MAHAVEER
INSTITUTE OF SCIENCE & TECHNOLOGY
Bandlaguda, Hyd-500 005.

HOD
Department of Humanities & Sciences
Mahaveer Institute of Science & Technology,
HYDERABAD

Vysapuri, Bandlaguda Post:Keshavgi,

Hyderabad-500 005, TELANGANA INDIA
Tel: 040-64596979,8978380692,Fax: 040-24455003
E-mail: e3hod.it@gmail.com,
Website: www.mist.ac.in,

MAHAVEER
INSTITUTE OF SCIENCE & TECHNOLOGY
Approved by AICTE, Affiliated to JNTUH,Hyd.



DEPARTMENT OF HUMANITIES AND SCIENCES

Date: 25-08-18

CIRCULAR

CRASH COURSE FOR I B.Tech students are starting from 25-08-18 onwards. All HODs and placements coordinators have to manage the trainings and ensure 95% attendance all through the sessions.

All mentors need to send the compiled feedback report to HOD at e3hod@gmail.com daily. Mentors are advised to take care of PNR (Students not participating in training).

Agenda: **communication skills**

Design and Development of Curriculum for Add on Course

Name of Faculty: 1.VINETHA
2.M,JAISHREE

PRINCIPAL
MAHAVEER
INSTITUTE OF SCIENCE & TECHNOLOGY
Bandlaguda, Hyd-500 005.

HOD
Department of Humanities & Sciences
Mahaveer Institute of Science & Technology,
HYDERABAD

Vysapuri, Bandlaguda Post:Keshavgiri,

Hyderabad-500 005, TELANGANA INDIA
Tel: 040-64596979,8978380692,Fax: 040-24455003
E-mail: e3hod.it@gmail.com,
Website: www.mist.ac.in,

MAHAVEER
INSTITUTE OF SCIENCE & TECHNOLOGY
Approved by AICTE, Affiliated to JNTUH,Hyd.

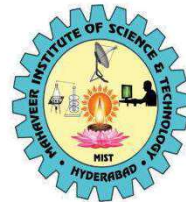

DEPARTMENT OF HUMANITIES AND SCIENCES

Syllabus for communication skills

SNO	TOPIC COVERED	DURATION
1	Why communication skills important	3
2	How to improve your communication skills	3
3	just a minute	3
4	Group discussion	3
5	Interview skills	3
6	Workplace awareness	3
7	Learn professional ethics	3
8	Understand gender equality at the workplace	3

PRINCIPAL
MAHAVEER
INSTITUTE OF SCIENCE & TECHNOLOGY
Bandlaguda, Hyd-500 005.

HOD
Department of Humanities & Sciences
Mahaveer Institute of Science & Technology
HYDERABAD

Vysapuri, Bandlaguda Post:Keshavgiri,

Hyderabad-500 005, TELANGANA INDIA
Tel: 040-64596979,8978380692,Fax: 040-24455003
E-mail: e3hod.it@gmail.com,
Website: www.mist.ac.in,

MAHAVEER
INSTITUTE OF SCIENCE & TECHNOLOGY
Approved by AICTE, Affiliated to JNTUH,Hyd.



DEPARTMENT OF HUMANITIES AND SCIENCES

LIST OF REGISTERED STUDENTENS FOR COMMUNICATOION SKILLS

SNO	HOLL TICKET NO	NAME OF THE STUDENT
1	18E31A0439	B. NAVEEN KUMAR
2	18E31A0443	G. SHIVA SAI GUPTA
3	18E31A0447	HAMLIPUR SANTOSH
4	18E31A0454	KOUSHIK AVULA
5	18E31A0564	M VINAY KUMAR
6	18E31A0566	M. AISHWARYA
7	18E31A0578	R. A. SUBRAMANYAM
8	18E31A0504	ADNAN ALI AHMED
9	18E31A0510	CHENNU VIVEK
10	18E31A0512	ERIVENTI RAKESH
11	18E31A0523	KUMMARI GANESH
12	18E31A0560	CHANDRACHARYA
13	18E31A0564	M VINAY KUMAR
14	18E31A0573	P. PADMAVATHI
15	18E31A1205	B. SHIRSHIKA
16	18E31A1209	DANDU SRINU
17	18E31A1215	LUNAVATH PAVAN
18	18E31A1220	19P BISHWAJITH
19	18E31A1225	SYED TURAB ALI
20	18E31A2112	M GOURISHANKAR
21	18E31A2116	NASRULLAH KHAN
22	18E31A2120	NUNNA DEEPAK
23	18E31A2126	SANGU VIJAYENDER
24	18E31A2129	TAPATTLA RADHIKA
25	18E31A2131	YERRA JOSHI

Keshav

PRINCIPAL
MAHAVEER
INSTITUTE OF SCIENCE & TECHNOLOGY
Bandlaguda, Hyd-500 005.

M Ratibha

HOD
Department of Humanities & Sciences
Mahaveer Institute of Science & Technology
HYDERABAD

Vysapuri, Bandlaguda Post:Keshavgiri,

Hyderabad-500 005, TELANGANA INDIA

Tel: 040-64596979,8978380692,Fax: 040-24455003

E-mail: e3hod.it@gmail.com,

Website: www.mist.ac.in,

MAHAVEER
INSTITUTE OF SCIENCE & TECHNOLOGY
Approved by AICTE, Affiliated to JNTUH,Hyd.



DEPARTMENT OF HUMANITIES AND SCIENCES

COMMUNICATION SKILLS QUESTION PAPER

Answer any 5 questions

5*10=50

1. Why communication skills are so important
2. How to improve your communication skills?
3. How to avoid common mistakes?
4. What are the professional ethics?
5. What are the different types of body languages?
6. How to get the confidence to face an interview

PRINCIPAL
MAHAVEER
INSTITUTE OF SCIENCE & TECHNOLOGY
Bandlaguda, Hyd-500 005.

Vysapuri, Bandlaguda Post:Keshavgiri,

Hyderabad-500 005, TELANGANA INDIA
Tel: 040-64596979,8978380692,Fax: 040-24455003
E-mail: e3hod.it@gmail.com,
Website: www.mist.ac.in,

MAHAVEER
INSTITUTE OF SCIENCE & TECHNOLOGY
Approved by AICTE, Affiliated to JNTUH,Hyd.



DEPARTMENT OF HUMANITIES AND SCIENCES

RESULT SHEET FOR ULTRASONICS REGISTERED STUDENTS

SNO	HOLL TICKET NO	NAME OF THE STUDENT	MARKS(20)	RESULT
1	18E31A0439	B. NAVEEN KUMAR	19	PASS
2	18E31A0443	G. SHIVA SAI GUPTA	19	PASS
3	18E31A0447	HAMLIPUR SANTOSH	20	PASS
4	18E31A0454	KOUSHIK AVULA	18	PASS
5	18E31A0564	M VINAY KUMAR	18	PASS
6	18E31A0566	M. AISHWARYA	19	PASS
7	18E31A0578	R. A. SUBRAMANYAM	18	PASS
8	18E31A0504	ADNAN ALI AHMED	20	PASS
9	18E31A0510	CHENNU VIVEK	18	PASS
10	18E31A0512	ERIVENTI RAKESH	19	PASS
11	18E31A0523	KUMMARI GANESH	19	PASS
12	18E31A0560	CHANDRACHARYA	19	PASS
13	18E31A0564	M VINAY KUMAR	20	PASS
14	18E31A0573	P. PADMAVATHI	20	PASS
15	18E31A1205	B. SHIRSHIKA	19	PASS
16	18E31A1209	DANDU SRINU	19	PASS
17	18E31A1215	LUNAVATH PAVAN	19	PASS
18	18E31A1220	19P BISHWAJITH	18	PASS
19	18E31A1225	SYED TURAB ALI	18	PASS
20	18E31A2112	M GOURISHANKAR	20	PASS
21	18E31A2116	NASRULLAH KHAN	18	PASS
22	18E31A2120	NUNNA DEEPAK	17	PASS
23	18E31A2126	SANGU VIJAYENDER	16	PASS
24	18E31A2129	TAPATTLA RADHIKA	20	PASS
25	18E31A2131	YERRA JOSHI	19	PASS

No.of students registred:20

No.of students passed :20

No.of students failed :Nil

PRINCIPAL
MAHAVEER
INSTITUTE OF SCIENCE & TECHNOLOGY
Bandlaguda, Hyd-500 005.

HOD
Department of Humanities & Sciences
Mahaveer Institute of Science & Technology
HYDERABAD

Vysapuri, Bandlaguda Post:Keshavgiri,

Hyderabad-500 005, TELANGANA INDIA
Tel: 040-64596979,8978380692,Fax: 040-24455003
E-mail: e3hod.it@gmail.com,
Website: www.mist.ac.in,

MAHAVEER
INSTITUTE OF SCIENCE & TECHNOLOGY
Approved by AICTE, Affiliated to JNTUH,Hyd.



DEPARTMENT OF HUMANITIES AND SCIENCES

SUMMARY REPORT OF CERTIFICATE COURSE ON COMMUNICATION SKILLS

Communication is process by which information is exchanged between individuals through a common system of symbols, signs, or behaviour. Communication is a source of information to the organizational members for decision-making process. Communication also helps in socializing. communication also assists in controlling process. Effective communication is a part and parcel of any successful organization. A communication should be free from barriers so as to be effective. Communication is a two way process where the message sent by the sender should be interpreted in the same terms by the recipient.

COPY TO:

1. Department notice board.
2. Principal for information
3. committee members (academic)

PRINCIPAL
MAHAVEER
INSTITUTE OF SCIENCE & TECHNOLOGY
Bandlaguda, Hyd-500 005.



**MAHAVEER INSTITUTE OF
SCIENCE AND TECHNOLOGY**
APPROVED BY AICTE AFFILIATED TO JNTUH - HYD.

DEPARTMENT OF
HUMANITIES AND SCIENCES

Certificate

This is to certify that Mr/Ms **D SRINU** _____
bearing Hall Ticket No **18E31A1209** of B.Tech First Year
has participated In Certificate course on
COMMUNICATION SKILLS

From **25-08-18** to **18-09-18** _

Organized by Dept. of Humanities and Sciences

M. Ratilha

HEAD
DEPARTMENT OF HUMANITIES AND SCIENCES
MAHAVEER INSTITUTE OF SCIENCE & TECHNOLOGY
HYDERABAD

K. Srinivas

PRINCIPAL
MAHAVEER
INSTITUTE OF SCIENCE & TECHNOLOGY
HYDERABAD

Vysapuri, Bandlaguda Post:Keshavpuri,
Hyderabad-500 035, Telangana INDIA
Tel: 040-64596979,20020773, Fax: 040-24455003
E-mail: principal.mahaveer@gmail.com,
Website: www.mist.ac.in,

MAHAVEER
INSTITUTE OF SCIENCE & TECHNOLOGY
Approved by AICTE, Affiliated to JNTUH,Hyd.



PROPOSAL LETTER

Hyderabad,

27/07/2019.

To,
The principal,
MIST,
Hyderabad.

Sub: Proposal for two weeks workshop on AUTO CAD-Reg.

Dear Sir,

We are working as asst professor in the department of CIVIL ENGINEERING. Sir, we are going to conduct two weeks workshop on AUTO CAD. We require your approval to go head for further proceeding and hope to get an opportunity to serve you the best .

With thanks and Regards



K. Subudh
PRINCIPAL
MAHAVEER
INSTITUTE OF SCIENCE & TECHNOLOGY
Bandlaguda, Hyderabad.

From,
Civil Department
Mist,
Bandlaguda,
Hyderabad.



Date: 29.07.2019

CIRCULAR

Technical Training for II B. Tech students are starting from 1st Aug, 2019 onwards. All HODs and Placements coordinators have to manage the trainings and ensure 95% attendance all through the sessions.

All Mentors need to send the compiled feedback report to CH Swethamber, HOD at e3hod.civil@gmail.com daily.

Agenda: I. Introduction to AUTOCAD.

Designed by: B RAMANA KUMAR



Ch. Swethamber
HOD

Kbaly
PRINCIPAL
MAHAVEER
INSTITUTE OF TECHNOLOGY
BANDLAGUDA, HYD 500005



Auto CAD SYLLABUS

1: Getting Started with AutoCAD

- Opening and Creating Drawings
- Exploring the AutoCAD interface
- Zooming and Panning

2: Basic Drawing & Editing Commands

- Using the Mouse, Keyboard, and Enter Key to work quickly and efficiently in AutoCAD
- Lines
- Circles
- Rectangles

3: Projects - Creating a Simple Drawing

- Creating Simple Drawings
- Using Object Snap Tracking to extrapolate a projected top view
- Using Modify tools to arrange an office layout

4: Drawing Precision in AutoCAD

- Polar and Ortho Tracking
- Entering Coordinates and Angles
- Object Snaps and Tracking

5: Making Changes in Your Drawing

- Move
- Copy
- Rotate
- Mirror
- Scale
- Using the reference option with the Scale Tool

7: Organizing Your Drawing with Layers

- Layer States
- Properties by Layer
- Layer Tools

Keshavgi
PRINCIPAL
MAHAVEER

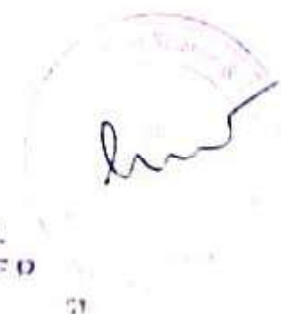

8: Advanced Object Types

- Polylines
- Arcs
- Polygons
- Ellipses

9: Advanced Editing Commands

- Trim and Extend
- Fillet and Chamfer
- Polyline Edit and Spline
- Offset and Explode
- Join

10: Inserting Blocks

- The Insert Block Command
- Inserting Blocks with Tool Palettes
- Dynamic Blocs
- Migrating Blocks and other Elements between Drawings with Design Center

11: Text

- The Multiline Text Tool
- The Single Line Text Tool
- Editing Text
- Text in Model Space vs. Paper Space
- The Multileader Tool

12: Hatching

- The Hatch Command
- The Hatch Editor Ribbon Tab
- Saving and Applying Hatches with Tool Palettes

13: Adding Dimensions

- Using Dimensioning Tools
- Dimensioning in a Layout Tab vs. the Model Tab
- Using Dimension Styles
- Editing Dimensions

14. Projects - Annotating Your Drawing

- Dimensioning a Mechanical Drawing

Khanij
PRINCIPAL
MAHAVEER
INSTITUTE OF SCIENCE & TECHNOLOGY
P.O. Box 1000, Gurgaon, Haryana

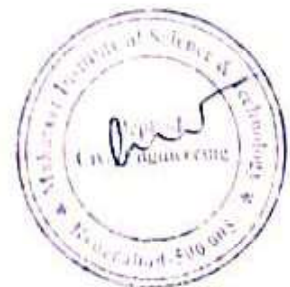

Vysapuri, Bandlaguda Post:Keshavgiri,
Hyderabad-500 005, Telangana INDIA
Tel: 040-64596979,20020773, Fax: 040-24455003
E-mail: principal.mahaveer@gmail.com,
Website: www.mist.ac.in,

MAHAVEER

INSTITUTE OF SCIENCE & TECHNOLOGY

Approved by AICTE, Affiliated to JNTUH,Hyd.



Department of Civil Engineering
Auto CAD Technical Training student attendance list 2019-20

S.No	Hall Ticket No	Name of the Candidate	Year
1	18E31A0101	A SRILEKHA	II
2	18E31A0102	BHUKYA ANIL NAYAK	II
3	18E31A0103	CHETPELly SANJEEV	II
4	18E31A0104	DEVULAPALLY CHANDRA VARDHAN	II
5	18E31A0105	DHARAVATH JAYASIMHA	II
6	18E31A0106	DHARAVATH KALYAN	II
7	18E31A0107	DHARAVATH TARUN KUMAR JADAV	II
8	18E31A0108	DURGAM YUVAKUMAR	II
9	18E31A0109	GOPU HARSHA VARDHAN REDDY	II
10	18E31A0111	GURRAPUJALA VINITH	II
11	18E31A0112	JABU VIVEK	II
12	18E31A0113	KATTA MANISH	II
13	18E31A0114	KUDUMULA REVANT REDDY	II
14	18E31A0115	MOHAMMAD YAKUB NADEEM	II
15	18E31A0116	MOHAMMED MUJAHED	II
16	18E31A0117	MOHAMMED SHOAB	II

K. Srinivas
PRINCIPAL
MAHAVEER
INSTITUTE OF SCIENCE & TECHNOLOGY
Bandlaguda, Hyd-500 005



17	18E31A0118	MOHD ABDUL WAJAHATH	II
18	18E31A0119	MUJTABA ALI ATIF	II
19	18E31A0120	NUNAVATH NAVEENRAM	II
20	18E31A0121	PEDDOLA PREM SAI	II
21	18E31A0122	RAMAGIRI CHARAN	II
22	18E31A0123	RATHLAVATH BALRAJ	II
23	18E31A0124	RAVUBA SHANKER	II
24	18E31A0125	RAYKODE NIKHIL	II
25	18E31A0126	RAYYAN AHMED	II
26	18E31A0127	ROYYA BHARATH	II
27	18E31A0128	SHAGA BHEEM REDDY	II
28	18E31A0129	SOMARAM AKASH	II
29	18E31A0130	SYED FAISAL HASSAN	II
30	18E31A0131	YARRANAGULA VEERENDAR	II
31	19E35A0101	AGIRISHETTY VIVEK VARDHAN	II
32	19E35A0102	BEERLA VINOD	II
33	19E35A0103	CHEGURI GOUTHAM GOUD	II
34	19E35A0104	DARIPALLI NARMADA	II
35	19E35A0105	DEVULAPALLY KASTHURI	II
36	19E35A0106	GALI RAKESH	II
37	19E35A0107	KINNERA TARUN KUMAR	II

PRINCIPAL
MAHAVEER
 INSTITUTE OF ENGINEERING & TECHNOLOGY
 Banchoojala, Hydr-500 005.



38	19E35A0108	KOTHA KARTHIK GOUD	II
39	19E35A0109	KUMMARI SAI KISHORE	II
40	19E35A0110	KUMMARI SRISAILAM	II
41	19E35A0111	M ARUN	II
42	19E35A0112	MADAMSHETTI HEMANTH	II
43	19E35A0113	MOHAMMED ABDUL PARVEZ	II
44	19E35A0114	MOHAMMED ALTHAF	II
45	19E35A0115	MUNAGAPATI BHARATH	II
46	19E35A0116	NENAVATH SHIRISHA	II
47	19E35A0117	POTLACHERUVU NAVEEN	II
48	19E35A0118	PUTTAGUNTA SRILATHA	II
49	19E35A0119	SADVIKA JILLA	II
50	19E35A0120	SINGARAM NARSING RAO	II
51	19E35A0121	THOTLA JAYANTH	II
52	17E31A0104	BATHULA RAVITEJA	II
53	17E31A0111	DAMALLA RAKESH	II
54	17E31A0130	MUSHAM SHIVA KUMAR	II
55	17E31A0133	OWAIS BIN HASSAN	II
56	17E31A0145	YOUSUF MOHAMMED KHAN	II



Khan
PRINCIPAL
MAHMOOD
 INSTITUTE
 BANGALORE

MAHAVEER INSTITUTE OF SCIENCE & TECHNOLOGY, HYDERABAD

CIVIL ENGINEERING STUDENTS ATTENDANCE

B.TECH II YEAR I SEM 2019-2020 BATCH (Date: 1-8-2019 to 13-8-2019)

S.No	Hall Ticket No	Name of the Candidate	1	2	3	4	5	6	7	8	9	10
1	18E31A0101	A SRILEKHA	P	P	P	A	P	P	P	P	P	P
2	18E31A0102	BHUKYA ANIL NAYAK	P	A	P	P	P	A	P	P	P	P
3	18E31A0103	CHEETPELLY SARJEEV	P	P	P	A	P	P	P	P	P	P
4	18E31A0104	DEVULAPALLY CHANDRA VARDHAN	A	P	P	P	P	P	P	P	A	P
5	18E31A0105	DHARAVATH JAVASIMHA	P	P	P	P	P	A	P	P	P	P
6	18E31A0106	DHARAVATH KALYAN	P	P	P	P	P	P	P	P	P	P
7	18E31A0107	DHARAVATH TABLUN KUMAR JADAV	A	P	P	P	P	P	P	P	P	P
8	18E31A0108	DURGAM YUVAKUMAR	P	A	P	P	P	P	P	P	P	P
9	18E31A0109	GOPU HARSIA VARDHAN REDDY	P	P	A	P	P	P	P	P	P	P
10	18E31A0111	GURRAPUSALA VINITH	A	P	P	P	P	P	P	P	P	A
11	18E31A0112	JABU VIVEK	P	P	P	A	P	P	P	P	P	P
12	18E31A0113	KATTA MANISH	P	P	P	A	P	P	P	A	P	P
13	18E31A0114	KUDUMULA REVANT REDDY	P	P	P	P	A	P	P	P	P	P
14	18E31A0115	MOHAMMAD YAKUB NADEEM	P	P	P	P	P	A	P	P	P	P
15	18E31A0116	MUHAMMED MUJAHED	P	P	P	P	P	A	P	P	P	P
16	18E31A0117	MOHAMMED SHOAIB	A	P	P	P	P	P	A	P	P	A
17	18E31A0118	MOHD ABDUL WAJAHATH	P	P	P	P	P	P	P	P	P	P
18	18E31A0119	MUJTABA ALI AJIF	P	P	P	P	P	P	P	P	P	P
19	18E31A0120	NUTHAVATH NAVEENRAM	A	P	P	P	P	A	P	P	P	P
20	18E31A0121	PEDDOLA PREM SAI	P	A	P	P	P	P	P	P	P	P
21	18E31A0122	RAMAGIRI CHARAN	P	P	P	P	P	A	P	P	P	P
22	18E31A0123	RATHAVATH BALRAJ	P	P	P	P	P	P	P	P	P	P
23	18E31A0124	RAVURA SHARIF	A	P	P	P	P	A	P	P	P	P
24	18E31A0125	RAYODE NIBHIL	P	A	P	P	P	P	P	P	P	P
25	18E31A0126	RAYAN AHMED	P	P	P	P	P	P	P	P	P	P
26	18E31A0127	ROVA BHARATH	P	P	P	P	P	A	P	P	P	P
27	18E31A0128	SHRAGA DHEEM REDDY	P	P	P	P	P	P	P	P	P	P



(Handwritten signature)

PRINCIPAL

MAHAVEER
INSTITUTE OF SCIENCE & TECHNOLOGY
HYDERABAD, HYD-500 005.



Technical Training Exam on Auto CAD Software
(A.Y-2019-20)

2x10=20 Marks

Answer All the Questions

1. Draw the given 2D model by using AutoCad

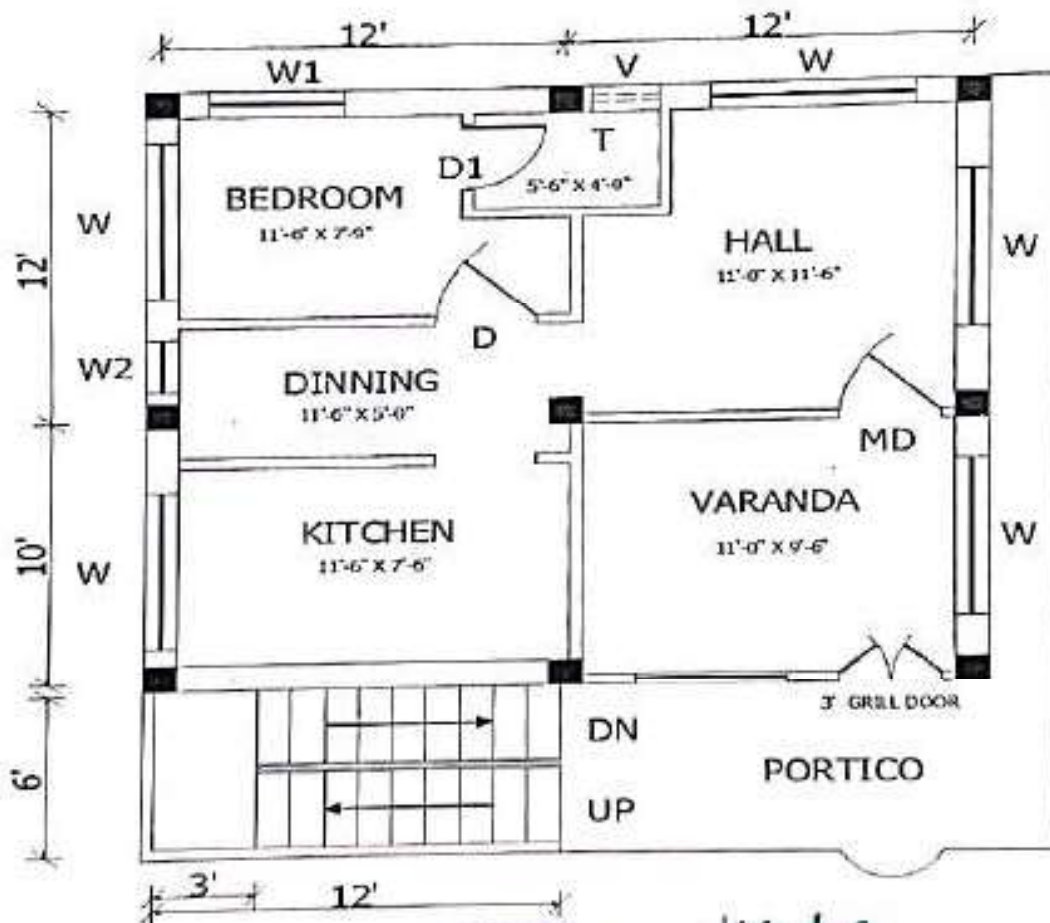

Kanish
PRINCIPAL
MAHAVEER
INSTITUTE OF SCIENCE & TECHNOLOGY
Bandlaguda, Hyd-500 005.

2. (a) Draw the following using any CAD software and add dimensioning.
 (b) List the commands in sequence and also write the procedure
 (c) Add title box containing Student PIN, name and college name

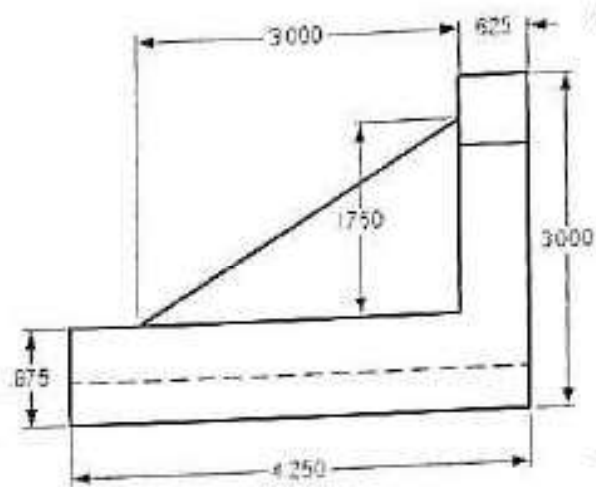
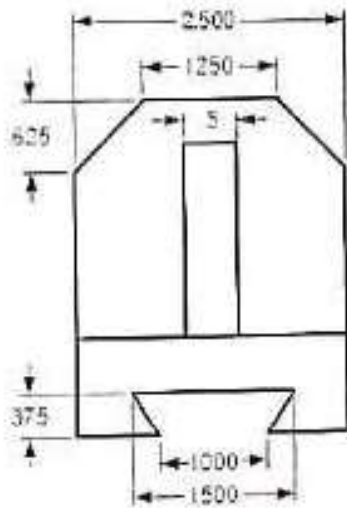

Asad
 PRINCIPAL
 MAHAVEER
 INSTITUTE OF SCIENCE & TECHNOLOGY
 Gandhinagar, Hyderabad-500 005



Department of Civil Engineering
Auto CAD Technical Training student attendance list 2019-20

S.No	Hall Ticket No	Name of the Candidate	Year	Marks	Pass/Fail
1	18E31A0101	A SRILEKHA	II	15	Pass
2	18E31A0102	BHUKYA ANIL NAYAK	II	16	Pass
3	18E31A0103	CHETPELly SANJEEV	II	15	Pass
4	18E31A0104	DEVULAPALLY CHANDRA VARDHAN	II	15	Pass
5	18E31A0105	DHARAVATH JAYASIMHA	II	17	Pass
6	18E31A0106	DHARAVATH KALYAN	II	16	Pass
7	18E31A0107	DHARAVATH TARUN KUMAR JADAV	II	16	Pass
8	18E31A0108	DURGAM YUVAKUMAR	II	17	Pass
9	18E31A0109	GOPU HARSHA VARDHAN REDDY	II	15	Pass
10	18E31A0111	GURRAPUSALA VINITH	II	15	Pass
11	18E31A0112	JABU VIVEK	II	16	Pass
12	18E31A0113	KATTA MANISH	II	15	Pass
13	18E31A0114	KUDUMULA REVANT REDDY	II	18	Pass
14	18E31A0115	MOHAMMAD YAKUB NADEEM	II	18	Pass
15	18E31A0116	MOHAMMED MUJAHED	II	13	Pass
16	18E31A0117	MOHAMMED SHOAIB	II	14	Pass
17	18E31A0118	MOHD ABDUL WAJAHATH	II	15	Pass
18	18E31A0119	MUJTABA ALI ATIF	II	15	Pass



K. S. S.
PRINCIPAL
MAHAVEER
 INSTITUTION
 BANGALORE, KARNATAKA, INDIA

19	18E31A0120	NUNAVATH NAVEENRAM	II	16	Pass
20	18E31A0121	PEDDOLA PREM SAI	II	16	Pass
21	18E31A0122	RAMAGIRI CHARAN	II	15	Pass
22	18E31A0123	RATHLAVATH BALRAJ	II	16	Pass
23	18E31A0124	RAVUBA SHANKER	II	17	Pass
24	18E31A0125	RAYKODE NIKHIL	II	15	Pass
25	18E31A0126	RAYYAN AHMED	II	15	Pass
26	18E31A0127	ROYYA BHARATH	II	15	Pass
27	18E31A0128	SHAGA BHEEM REDDY	II	16	Pass
28	18E31A0129	SOMARAM AKASH	II	15	Pass
29	18E31A0130	SYED FAISAL HASSAN	II	16	Pass
30	18E31A0131	YARRANAGULA VEERENDAR	II	16	Pass
31	19E35A0101	AGIRISHETTY VIVEK VARDHAN	II	17	Pass
32	19E35A0102	BEERLA VINOD	II	18	Pass
33	19E35A0103	CHEGURI GOUTHAM GOUD	II	18	Pass
34	19E35A0104	DARIPALLI NARMADA	II	16	Pass
35	19E35A0105	DEVULAPALLY KASTHURI	II	17	Pass
36	19E35A0106	GALI RAKESH	II	18	Pass
37	19E35A0107	KINNERA TARUN KUMAR	II	17	Pass

K. Srinivas
 PRINCIPAL
MAHAVEER
 INSTITUTE OF SCIENCE & TECHNOLOGY
 BANGALURU



38	19E35A0108	KOTHA KARTHIK GOUD	II	15	Pass
39	19E35A0109	KUMMARI SAI KISHORE	II	16	Pass
40	19E35A0110	KUMMARI SRISAILAM	II	15	Pass
41	19E35A0111	M ARUN	II	14	Pass
42	19E35A0112	MADAMSHETTI HEMANTH	II	17	Pass
43	19E35A0113	MOHAMMED ABDUL PARVEZ	II	15	Pass
44	19E35A0114	MOHAMMED ALTHAF	II	15	Pass
45	19E35A0115	MUNAGAPATI BHARATH	II	16	Pass
46	19E35A0116	NENAVATH SHIRISHA	II	16	Pass
47	19E35A0117	POTLACHERUVU NAVEEN	II	15	Pass
48	19E35A0118	PUTTAGUNTA SRILATHA	II	16	Pass
49	19E35A0119	SADVIKA JILLA	II	16	Pass
50	19E35A0120	SINGARAM NARSING RAO	II	17	Pass
51	19E35A0121	THOTLA JAYANTH	II	18	Pass
52	17E31A0104	BATHULA RAVITEJA	II	18	Pass
53	17E31A0111	DAMALLA RAKESH	II	16	Pass
54	17E31A0130	MUSHAM SHIVA KUMAR	II	17	Pass
55	17E31A0133	OWAIS BIN HASSAN	II	18	Pass
56	17E31A0145	YOUSUF MOHAMMED KHAN	II	17	Pass



Kishu
PRINCIPAL
MAHAVEER
 Institute of Science & Technology
 B. H. Nagar, Guntur, Andhra Pradesh

Vysapuri, Bandlaguda Post:Keshavnagar,
Hyderabad-500 005, Telangana INDIA
Tel: 040-84596979,20020773, Fax: 040-24455003
E-mail: principal.mahaveer@gmail.com
Website: www.mahaveer.ac.in

MAHAVEER

INSTITUTE OF SCIENCE & TECHNOLOGY
Approved by AICTE, Affiliated to JNTUH, Hyd.



Auto CAD COURSE

Summary

Department of Civil Engineering

- Use AutoCAD for daily working process.
- Navigate throughout AutoCAD using major navigating tools.
- Understand the concept and techniques to draw.
- Create multiple designs using several of tools.
- Create layers to control the objects' visibility.
- Explain drawing using annotations.
- Plot or print the drawing by scale.



K. Srinivas
PRINCIPAL
MAHAVEER
INSTITUTE OF SCIENCE & TECHNOLOGY
Vysapuri, Bandlaguda Post, Hyderabad-500 005.

Vysapuri, Bandlaguda Post, Keshavnagar,
Hyderabad-500 605, Telangana INDIA
Tel: 040-64596979, 20020773, Fax: 040-24455003
E-mail: principal.mahaveer@gmail.com
Website: www.mist.ac.in

MAHAVEER

INSTITUTE OF SCIENCE & TECHNOLOGY
Approved by AICTE. Affiliated to JNTUH, Hyd.



CERTIFICATE OF COURSE COMPLETION

This certificate is presented to _____ of MIST, who has successfully completed technical training course on "Auto CAD" held from _____ to _____ and found the student performance to be excellent.



ESTD : 2001

Ch. Swethamber

HOD

Civil Department

Khanif
PRINCIPAL
MAHAVEER
INSTITUTE OF SCIENCE & TECHNOLOGY
BANDLAGUDA, HYD 500 605

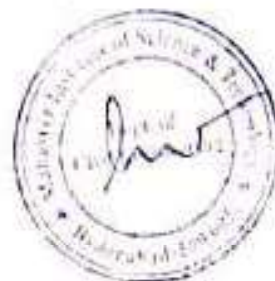

Vysapudi, Bandlaguda Post, Kuchhavirki,
Hyderabad-500 905, Telangana INDIA
Tel: 040-6496679,2002073, Fax: 040-24455003
E-mail: principal.mahaveer@gmail.com,
Website: www.mst.ac.in,

MAHAVEER

INSTITUTE OF SCIENCE & TECHNOLOGY
Approved by AICTE, Affiliated to JNTUH, Hydr.



DEPARTMENT OF CIVIL ENGINEERING

PROPOSAL LETTER

Hyderabad,

15/04/2019.

To,
The principal,
MIST,
Hyderabad.

Sub: Proposal for three weeks workshop on REVIT-Reg.

Dear Sir,

We are working as asst professor in the department of CIVIL ENGINEERING. Sir, we are going to conduct three weeks workshop on REVIT. We require your approval to go head for further proceeding and hope to get an opportunity to serve you the best.

With thanks and Regards



K. S. K. K.

PRINCIPAL
MAHAVEER
INSTITUTE OF SCIENCE & TECHNOLOGY
Bandlaguda, Hydr 500 005.

From,
Civil Department
Mist,
Bandlaguda.

Vysapuri, Bandlaguda Post:Keshavgiri,
Hyderabad-500 005, Telangana INDIA
Tel: 040-64596979,20020773, Fax: 040-24455003
E-mail: principal.mahaveer@gmail.com,
Website: www.misl.ac.in,

MAHAVEER

INSTITUTE OF SCIENCE & TECHNOLOGY
Approved by AICTE, Affiliated to JNTUH,Hyd.



Date: 01.05.2019

CIRCULAR

Technical Training for II B. Tech students are starting from 1st MAY, 2019 onwards. All HODs and Placements coordinators have to manage the trainings and ensure 95% attendance all through the sessions.

All Mentors need to send the compiled feedback report to CH.Swethamber, HOD at e3hod.civil@gmail.com daily.

Agenda: 1. Introduction to Revit.

Designed By:- B.RAMANA KUMAR

P.DILIP KUMAR RAO

CHLSWETHAMBER

K. Swetha
PRINCIPAL
MAHAVEER
INSTITUTE OF SCIENCE & TECHNOLOGY
Bandlaguda, Hyderabad-500 005.





REVIT SYLLABUS

DAY	SUBJECT	KEYWORD
Day-1	Introduction to BIM & Autodesk Revit	1. Introduction to BIM & Revit 2. Version of Revit 3. Starting Projects 4. User Interface
Day-2	Setting up Levels & wall, adding components	1. Making Levels 2. wall setup 3. 3D Components (Interior & Exterior)
Day-3	Working with basic tools	7. Basic modify tools Moving, Copying, Mirror, Trim. 8. Working with additional modify tools
Day-4	Modelling Floors, Roofs, Stairs, Railings, Ceiling	1. Making floor & roof 2. Creating & Modifying stairs 3. Creating Railing 4. Adding Ceiling
Day-5	Working with Grid & Column	1. Creating & modify the Grid 2. Adding Column
Day-6	Working with Materials	1. Setting of Materials 2. Apply Texture & Color
Day-7	Creating Construction Documents	7. Making Sheetfile 8. Adding planes, elevations, section, 3D views
Day-8	Making Walkthrough	1. Use of camera 2. Making Animation
Day-9	Introduction to Revit Structure	1. Starting Projects 2. Overview of the interface
Day-10	Starting structural project & basic modify tools	1. Setting of levels & Grids 2. working with basic tools (Move, Rotate, Copy, Mirror)
Day-11	Working with views	1. Setting the view display 2. Creating Elevation & section
Day-12	Structural Grids & Columns	1. Adding Grids 2. Placing Columns
Day-13	Foundation	1. Modelling walls 2. Adding wall footing 3. Adding Isolated footing
Day-14	Adding Structural Slab	1. Creating & modify Slab
Day-15	Structural Reinforcement	1. Structural Reinforcement 2. Adding Rebar 3. Modify Rebar 4. Reinforcing Slabs

Kanishk

PRINCIPAL
MAHAVEER



Vysapuri, Bandlaguda Post, Keshavnagar,
Hyderabad-500 605, Telangana INDIA
Tel: 040-64596979, 20020773, Fax: 040-24455003
E-mail: principal.mahaveer@gmail.com,
Website: www.mst.ac.in

MAHAVEER

Approved by AICTE, Affiliated to JNTUH, Hyd.



Department of Civil Engineering Revit Technical Training student attendance list 2019-2020

SL.NO.	ROLL NO.	NAME OF THE STUDENT	YEAR
1	18E31A0101	A SRILEKHA	II
2	18E31A0102	BHUKYA ANIL NAYAK	II
3	18E31A0103	CHETPELLE SANJEEV	II
4	18E31A0105	DHARAVATH JAYASIMHA	II
5	18E31A0106	DHARAVATH KALYAN	II
6	18E31A0107	DHARAVATH TARUN KUMAR JADAV	II
7	18E31A0108	DURGAM YUVAKUMAR	II
8	18E31A0109	GOPU HARSHA VARDHAN REDDY	II
9	18E31A0112	JABU VIVEK	II
10	18E31A0116	MOHAMMED MUJAHED	II
11	18E31A0118	MOHD ABDUL WAJAHATH	II
12	18E31A0119	MUJTABA ALI ATIF	II
13	18E31A0120	NUNAVATH NAVEENRAM	II
14	18E31A0121	PEDDOLA PREM SAI	II
15	18E31A0122	RAMAGIRI CHARAN	II
16	18E31A0124	RAVUBA SHANKER	II
17	18E31A0128	SHAGA BHEEM REDDY	II
18	18E31A0129	SOMARAM AKASH	II
19	18E31A0130	SYED FAISAL HASSAN	II
20	18E31A0131	YARRANAGULA VEERENDAR	II

K. Srinivas
PRINCIPAL
MAHAVEER



MAHAVEER INSTITUTE OF TECHNOLOGY
Vysapuri, Bandlaguda Post, Hyderabad-500 605

21	19E35A0101	AGIRISHETTY VIVEK VARDHAN	II
22	19E35A0102	BEERLA VINOD	II
23	19E35A0103	CHEGURI GOUTHAM GOUD	II
24	19E35A0104	DARIPALLI NARMADA	II
25	19E35A0106	GALI RAKESH	II
26	19E35A0107	KINNERA TARUN KUMAR	II
27	19E35A0108	KOTHA KARTHIK GOUD	II
28	19E35A0109	KUMMARI SAI KISHORE	II
29	19E35A0110	KUMMARI SRISAILAM	II
30	19E35A0111	M ARUN	II
31	19E35A0112	MADAMSHETTI HEMANTH	II
32	19E35A0113	MOHAMMED ABDUL PARVEZ	II
33	19E35A0114	MOHAMMED ALTHAF	II
34	19E35A0115	MUNAGAPATI BHARATH	II
35	19E35A0116	NENAVATH SHIRISHA	II
36	19E35A0117	POTLACHERUVU NAVEEN	II
37	19E35A0118	PUTTAGUNTA SRILATHA	II
38	19E35A0119	SADVIKA JILLA	II
39	19E35A0120	SINGARAM NARSING RAO	II
40	19E35A0121	THOTLA JAYANTH	II
41	17E31A0104	BATHULA RAVITEJA	II
42	17E31A0111	DAMMALA RAKESH	II
43	17E31A0130	MUSHAN SHIVA KUMAR	II
44	17E31A0133	OWAIS BIN HASSAN	II
45	17E31A0145	YOUSUF MOHAMMED KHAN	II

PRINCIPAL
MAHAVEER
 INSTITUTE OF SCIENCE & TECHNOLOGY
 Kankajuguda, Hyderabad-500 005.

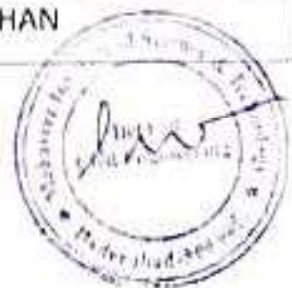

Department of Civil Engineering
Revit Technical Training student attendance list 2019-2020

Sl.No	Roll No	Name of the student	1	2	3	4	5	6	7	8	9	10	11	12	13	14	15
1	18E31A0101	A SRILEKHA	P	P	P	P	P	P	P	P	P	P	P	P	P	P	P
2	18E31A0102	BHUKYA ANIL NAYAK	P	P	P	P	P	P	P	P	P	P	P	P	P	P	P
3	18E31A0103	CHEPPELly SANJEEV	P	P	P	P	P	P	P	P	P	P	P	P	P	P	P
4	18E31A0105	DHARAVATH JAYASIMHA	P	P	P	P	P	P	P	P	P	P	P	P	P	P	P
5	18E31A0106	DHARAVATH KALYAN	P	P	P	P	P	P	P	P	P	P	P	P	P	P	P
6	18E31A0107	DHARAVATH TARUN KUMAR JADAV	P	P	P	P	P	P	P	P	P	P	P	P	P	P	P
7	18E31A0108	DURGAM YUVAKUMAR	P	P	P	P	P	P	P	P	P	P	P	P	P	P	P
8	18E31A0109	GOPU HARSHA VARDHAN REDDY	P	P	P	P	P	P	P	P	P	P	P	P	P	P	P
9	18E31A0112	JASU VIVEK	P	P	P	P	P	P	P	P	P	P	P	P	P	P	P
10	18E31A0116	MOHAMMED MUJAHED	P	P	P	P	P	P	P	P	P	P	P	P	P	P	P
11	18E31A0118	MOHD ABDUL WAJAHATH	P	P	P	P	P	P	P	P	P	P	P	P	P	P	P
12	18E31A0119	MUJTABA ALI ATIF	P	P	P	P	P	P	P	P	P	P	P	P	P	P	P
13	18E31A0120	NUNAVATH NAVEENRAM	P	P	P	P	P	P	P	P	P	P	P	P	P	P	P
14	18E31A0121	PEDDOLA PREM SAI	P	P	P	P	P	P	P	P	P	P	P	P	P	P	P
15	18E31A0122	RAMAGIRI CHARAN	P	P	P	P	P	P	P	P	P	P	P	P	P	P	P
16	18E31A0124	RAVUBA SHANKER	P	P	P	P	P	P	P	P	P	P	P	P	P	P	P
17	18E31A0128	SHAGA BHEEM REDDY	P	P	P	P	P	P	P	P	P	P	P	P	P	P	P
18	18E31A0129	SOMARAM AKASH	P	P	P	P	P	P	P	P	P	P	P	P	P	P	P
19	18E31A0130	SYED TAISAL HASSAN	P	P	P	P	P	P	P	P	P	P	P	P	P	P	P
20	18E31A0131	YARRANAGULA VEERENDAR	P	P	P	P	P	P	P	P	P	P	P	P	P	P	P
21	19E25A0101	AGRISHITTY VIVEK VARDHAN	P	P	P	P	P	P	P	P	P	P	P	P	P	P	P
22	19E35A0102	BEERLA VINOD	P	P	P	P	P	P	P	P	P	P	P	P	P	P	P
23	19E35A0103	CHEGURI GOUTHAM GOUD	P	P	P	P	P	P	P	P	P	P	P	P	P	P	P
24	19E35A0104	DARIPALLI NARMADA	P	P	P	P	P	P	P	P	P	P	P	P	P	P	P
25	19E35A0106	GALI RAJESH	P	P	P	P	P	P	P	P	P	P	P	P	P	P	P
26	19E35A0107	KUMMERA TARUNI KUMAR	P	P	P	P	P	P	P	P	P	P	P	P	P	P	P



APPROVED
TRINITY



Technical Training Exam on Revit Software
(A.Y-2019-20)

2x10=20 Marks

Answer All the Questions

1. Draw the given 2D model into 3D model by using Revit

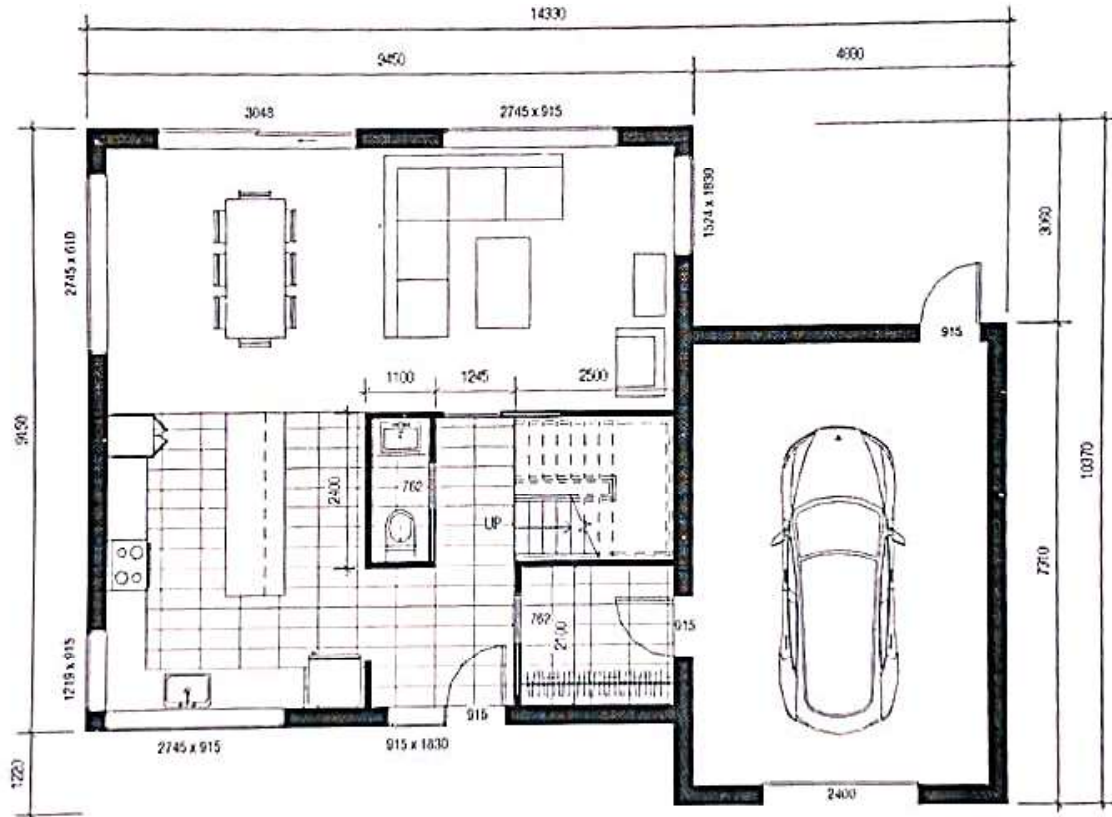

K. Kishore
PRINCIPAL
MAHAVEER
INSTITUTE OF SCIENCE & TECHNOLOGY
Bandlaguda, Hyderabad 500005



2. Draw the given centre to centre floor plan into 3D model by using Revit software.

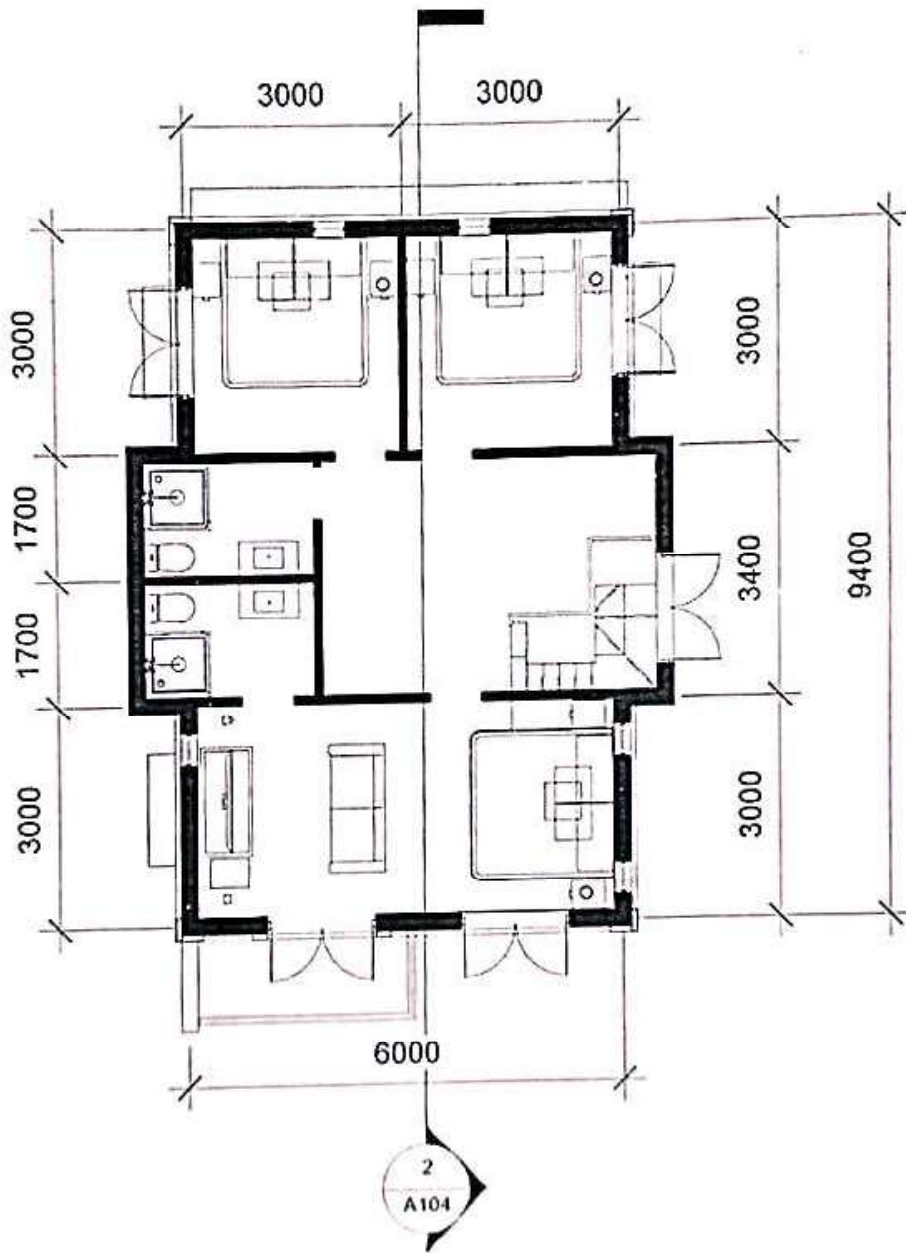

K. S. Mahaveer
PRINCIPAL
MAHAVEER
INSTITUTE OF SCIENCE & TECHNOLOGY
Bangalore, HY-1-500100



Vysapuri, Bandlaguda Post:Keshavgiri,
Hyderabad-500 005, Telangana INDIA
Tel: 040-64596979,20020773, Fax: 040-24455003
E-mail: principal.mahaveer@gmail.com
Website: www.mist.ac.in

MAHAVEER

INSTITUTE OF SCIENCE & TECHNOLOGY
Approved by AICTE, Affiliated to JNTUH,Hyd.



Department of Civil Engineering
Revit Technical Training student Marks list 2019-20

Sl.NO	Roll No	Name of the student	YEAR	MARKS	PASS/FAI
1	18E31A0101	A SRILEKHA	II	16	PASS
2	18E31A0102	BHUKYA ANIL NAYAK	II	16	PASS
3	18E31A0103	CHEPPELLY SANJEEV	II	12	PASS
4	18E31A0105	DHARAVATH JAYASIMHA	II	12	PASS
5	18E31A0106	DHARAVATH KALYAN	II	16	PASS
6	18E31A0107	DHARAVATH TARUN KUMAR JADAV	II	16	PASS
7	18E31A0108	DURGAM YUVAKUMAR	II	16	PASS
8	18E31A0109	GOPU HARSHA VARDHAN REDDY	II	16	PASS
9	18E31A0112	JABU VIVEK	II	16	PASS
10	18E31A0116	MOHAMMED MUJAHED	II	16	PASS
11	18E31A0118	MOHD ABDUL WAJAHATH	II	16	PASS
12	18E31A0119	MUJTABA ALI ATIF	II	16	PASS
13	18E31A0120	NUNAVATH NAVEENRAM	II	16	PASS
14	18E31A0121	PEDDOLA PREM SAI	II	16	PASS
15	18E31A0122	RAMAGIRI CHARAN	II	16	PASS
16	18E31A0124	RAVUBA SHANKER	II	16	PASS
17	18E31A0128	SHAGA BHEEM REDDY	II	16	PASS
18	18E31A0129	SOMARAM AKASH	II	16	PASS
19	18E31A0130	SYED FAISAL HASSAN	II	15	PASS
20	18E31A0131	YARRANAGULA VEERENDAR	II	16	PASS
21	19E35A0101	AGIRISHETTY VIVEK VARDHAN	II	16	PASS



PRINCIPAL
MAHAVEER
INSTITUTE OF SCIENCE & TECHNOLOGY
Bandlaguda, Hyd-500 005

22	19E35A0102	BEERLA VINOD	II	15	PASS
23	19E35A0103	CHEGURI GOUTHAM GOUD	II	16	PASS
24	19E35A0104	DARIPALLI NARMADA	II	14	PASS
25	19E35A0106	GALI RAKESH	II	15	PASS
26	19E35A0107	KINNERA TARUN KUMAR	II	15	PASS
27	19E35A0108	KOTHA KARTHIK GOUD	II	16	PASS
28	19E35A0109	KUMMARI SAI KISHORE	II	14	PASS
29	19E35A0110	KUMMARI SRISAILAM	II	16	PASS
30	19E35A0111	M ARUN	II	15	PASS
31	19E35A0112	MADAMSHETTI HEMANTH	II	14	PASS
32	19E35A0113	MOHAMMED ABDUL PARVEZ	II	18	PASS
33	19E35A0114	MOHAMMED ALTHAF	II	15	PASS
34	19E35A0115	MUNAGAPATI BHARATH	II	16	PASS
35	19E35A0116	NENAVATH SHIRISHA	II	15	PASS
36	19E35A0117	POTLACHERUVU NAVEEN	II	16	PASS
37	19E35A0118	PUTTAGUNTA SRILATHA	II	16	PASS
38	19E35A0119	SADVIKA JILLA	II	15	PASS
39	19E35A0120	SINGARAM NARSING RAO	II	18	PASS
40	19E35A0121	THOTLA JAYANTH	II	16	PASS
41	17E31A0104	BATHULA RAVITEJA	II	15	PASS
42	17E31A0111	DAMMALA RAKESH	II	16	PASS
43	17E31A0130	MUSHAN SHIVA KUMAR	II	15	PASS
44	17E31A0133	OWAIS BIN HASSAN	II	16	PASS
45	17E31A0145	YOUSUF MOHAMMED KHAN	II	18	PASS



K. Srinivas
PRINCIPAL
MAHAVEER
 INSTITUTE OF SCIENCE & TECHNOLOGY
 Gandlaguda, Hyd-500 005.

Vysapuri, Bandlaguda Post:Keshavgiri,
Hyderabad-500 005, Telangana INDIA
Tel: 040-64598979,20020773, Fax: 040-24455003
E-mail: principal.mahaveer@gmail.com
Website: www.mist.ac.in

MAHAVEER

INSTITUTE OF SCIENCE & TECHNOLOGY
Approved by AICTE, Affiliated to JNTUH,Hyd.



Revit COURSE
Summary

Department of Civil Engineering

- Use Revit for daily working process.
- Navigate throughout Revit using major navigating tools.
- Understand the concept and techniques to draw.
- Create multiple designs using several of tools.
- Create layers to control the objects' visibility.
- Explain drawing using annotations.
- Plot or print the drawing by scale.
- To use constraint for certain design.

K. Srinivas
PRINCIPAL
MAHAVEER
INSTITUTE OF SCIENCE & TECHNOLOGY
BANDLAGUDA POST, KESHAVGIRI,
VYSAPURI, HYDERABAD-500 005

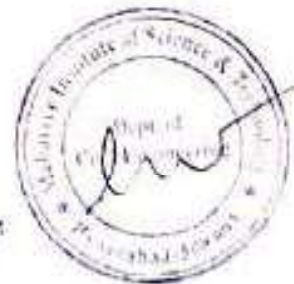

Vysapuri, Bandlaguda Post, Keshavnagar,
Hyderabad-500 005, Telangana INDIA
Tel: 040-64596979, 20020773, Fax: 040-24455003
E-mail: principal.mahaveer@gmail.com
Website: www.mist-ac.in

MAHAVEER

INSTITUTE OF SCIENCE & TECHNOLOGY
Approved by AICTE, Affiliated to JNTUH, Hyd.



CERTIFICATE OF COURSE COMPLETION

This certificate is presented to _____ of MIST, who has successfully completed technical training course on "Revit" held from _____ to _____ and found the student performance to be excellent.



ESTD : 2001

CH.SWETHAMBER

HOD

Civil Department

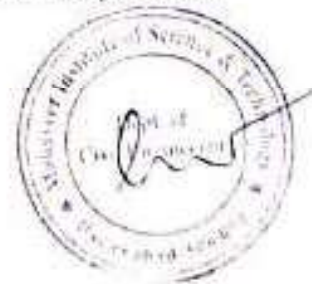

Khanif
PRINCIPAL
MAHAVEER
INSTITUTE OF SCIENCE & TECHNOLOGY
HYDERABAD - 500 005

Vysapuri, Bandlaguda Post:Keshavgi,
Hyderabad-500 005, Telangana INDIA
Tel: 040-64596979,20020173, Fax: 040-24455003
E-mail: principal.mahaveer@gmail.com
Website: www.mist.ac.in,

MAHAVEER

INSTITUTE OF SCIENCE & TECHNOLOGY
Approved by AICTE, Affiliated to JNTUH,Hyd



DEPARTMENT OF CIVIL ENGINEERING

PROPOSAL LETTER

Hyderabad,

12/08/2019.

To,
The principal,
MIST,
Hyderabad.

Sub: Proposal for three weeks workshop on ETABS-Reg.

Dear Sir,

We are working as asst professor in the department of CIVIL ENGINEERING, Sir, we are going to conduct three weeks workshop on ETABS. We require your approval to go head for further proceeding and hope to get an opportunity to serve you the best.

With thanks and Regards

From,
Civil Department
Mist,
Bandlaguda,



K. Sankar
PRINCIPAL
MAHAVEER
INSTITUTE OF SCIENCE & TECHNOLOGY
bandlaguda, Hyd-500 005.

Vysapuri, Bandlaguda Post:Keshavgirl,
Hyderabad-500 095, Telangana INDIA
Tel: 040-64596979,20020773..Fax: 040-24455003
E-mail: principal.mahaveer@gmail.com,
Website: www.mist.ac.in,

MAHAVEER

INSTITUTE OF TECHNOLOGY
Approved by AICTE, Affiliated to JNTUH,Hyd.



DEPARTMENT OF CIVIL ENGINEERING

CIRCULAR

Hyderabad.

Date: 21.08.2019

Technical Training for III B. Tech students are starting from 21 -08- 2019 onwards. All HODs and Placements coordinators have to manage the trainings and ensure 95% attendance all through the sessions.

All Mentors need to send the compiled feedback report to Ch.Swethamber, HOD at e3hod.civil@gmail.com daily.

Agenda: 1. Introduction to ETABS.

CH.SWETHAMBER

HOD

Designed by : L.JYOTHI

G PUSHPALATHIA

K. S. S. S.
PRINCIPAL
MAHAVEER



Vysapuri, Bandlaguda Post:Keshavpuri,
Hyderabad-500 005, Telangana INDIA
Tel: 040-64596979,20020773, Fax: 040-24455003
E-mail: principal.mahaveer@gmail.com
Website: www.misti.ac.in

MAHAVEER

INSTITUTE OF SCIENCE & TECHNOLOGY

Approved by AICTE, Affiliated to JNTUH,Hyd.



DEPARTMENT OF CIVIL ENGINEERING

ETABS SYLLABUS

- 1: The knowledge about specialized software such as ETABS, SAFE to model and analyze for buildings.
- 2: Be able to model, analyze, and solve structural models on Specialized software and access analysis results such as force, Displacement and another parameter for structural design.
- 3: Be able to communicate and work in the group flexibly and Efficiently.
- 4: Explaining concepts, terminology and rules used in ETABS, SAFE software.
- 5: Modeling and analyzing type of simple and complex structural Systems.
- 6: Analyzing and determining the values of internal forces, Displacements and other parameters for structural design.
- 7: Working in the group to solve the problems relates to using Software ETABS, SAFE.
- 8: Choosing appreciable communication skills such as speech, Text, images, graphics, when expressing personal views.



M. Sankar
PRINCIPAL
MAHAVEER
INSTITUTE OF
SCIENCE & TECHNOLOGY
BANDLAGUDA

Vysapuri, Bandlaguda Post:Keshavgiri,
Hyderabad-500 005, Telangana INDIA
Tel: 040-64596979,20020773, Fax: 040-24455003
E-mail: principal.mahaveer@gmail.com
Website: www.mist.ac.in

MAHAVEER

INSTITUTE OF SCIENCE & TECHNOLOGY
Approved by AICTE. Affiliated to JNTUH,Hyd



DEPARTMENT OF CIVIL ENGINEERING

ETABS Technical Training student Marks list 2019-20

S.No	Hall Ticket No	Name of the Candidate
1	17E31A0101	ANNALDASJANAKI
2	17E31A0102	ARSHIFIRDAUSH
3	17E31A0103	BSOHANLAL
4	17E31A0105	BHUKYARAJU
5	17E31A0106	BHUKYARAVIKUMAR
6	17E31A0107	BOLLAMVIJAYKUMAR
7	17E31A0108	CHELUMALLAVIKASREDDY
8	17E31A0109	CHIENNAKESHIMANIKANTAMUDHIRAJ
9	17E31A0110	DTEJA
10	17E31A0113	DEVALLASMARANI
11	17E31A0116	HALAVATHHARIKRISHNA
12	17E31A0121	MAGHANUDDIN
13	17E31A0122	MADDELAARUNKUMAR
14	17E31A0125	MOHAMMEDMUQTARPATEL

K. S. S.
PRINCIPAL
MAHAVEER
INSTITUTE OF SCIENCE & TECHNOLOGY
Bandlaguda, Hyderabad-500 005.



Vysapuri, Bandlaguda Post:Keshavnagar,
Hyderabad-500 095, Telangana INDIA
Tel: 040-64596979, 20020773, Fax: 040-24455003
E-mail: principal.mahaveer@gmail.com,
Website: www.mst.ac.in,

MAHAVEER

INSTITUTE OF SCIENCE & TECHNOLOGY
Approved by AICTE, Affiliated to JNTU, Hyd



15	17E31A0128	MOHIDMAJEEDUDDIN
16	17E31A0135	PAKALASAIPRASAD
17	17E31A0138	SHARAVATHSREEDHER
18	17E31A0139	SHIVARATRINKUMAR
19	17E31A0140	SIDDAMSETTIAVINASH
20	17E31A0141	SKREHMATHBABA
21	17E31A0142	SUNKARAHARSHAVARDHAN
22	17E31A0143	TURUKAPAVANI
23	17E31A0144	YATHAMSAIYASHASWINI
24	18E35A0101	ADNANABDULWASE
25	18E35A0102	BADALAVARAPRASAD
26	18E35A0105	DONTHARABOINAKIRANKUMAR
27	18E35A0106	KOLLAKRANTHIKUMAR
28	18E35A0107	MANKATUSHALYADAV
29	18E35A0108	MERUGUROTHI
30	18E35A0109	MULLUKUNILAMOONIKA
31	18E35A0110	POCHAGARIALOK
32	18E35A0111	PDEEPASREI
33	18E35A0112	PRAGHAVENDAR

K. S. S. S.
PRINCIPAL
MAHAVEER
INSTITUTE OF SCIENCE & TECHNOLOGY
VYSAPURI, BANDLAGUDA POST, KESHAVNAGAR,
HYDERABAD-500 095, TELANGANA INDIA



Vysapuri, Bandlaguda Post:Keshavgiri,
Hyderabad-500 005, Telangana INDIA
Tel: 040-64595979,20920773, Fax: 040-24455003
E-mail: principal.mahaveer@gmail.com
Website: www.mist.ac.in

MAHAVEER

INSTITUTE OF SCIENCE & TECHNOLOGY

Approved by AICTE, Affiliated to JNTUH,Hyd.



34	18E35A0113	SANDADITEJASWINI
35	18E35A0114	UPUTHALLIVENUGOPAL
36	17H11A0102	ABUBAKAR
37	17H11A0118	MOHAMMEDALTHAF
38	17H11A0119	MOHAMMEDASIMADNAN
39	15E31A0102	ABDULGAFFAR
40	19E38A0101	GOTTIMUKKALAVENKATAABHIGYANSHARMA

K. Anil
PRINCIPAL
MAHAVEER
INSTITUTE OF SCIENCE & TECHNOLOGY
Bandlaguda, Hyd-500 005

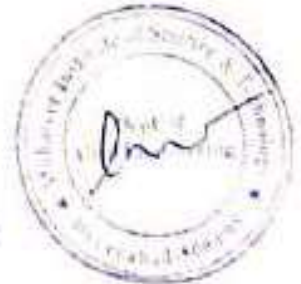

MAHAVEER INSTITUTE OF SCIENCE & TECHNOLOGY, HYDERABAD

CIVIL ENGINEERING STUDENTS ATTENDANCE

B.TECH III YEAR I SEMESTER 2019-2020 BATCH II (Date: 21-8-2019 to 31-8-2019)

S.No	Hall Ticket No	Name of the Candidate	1	2	3	4	5	6	7	8	9	10
1	17E31A0101	ANNALDAS JANAKI	P	P	P	P	A	P	P	P	P	P
2	17E31A0102	ARSHI FIRDAUSH	A	P	P	P	P	P	P	P	P	P
3	17E31A0103	B SOHAN LAL	P	P	A	P	P	P	P	P	P	P
4	17E31A0105	BHUKYA RAJU	P	P	P	A	P	P	P	A	P	P
5	17E31A0106	BHUKYA RAVIKUMAR	P	P	P	P	P	A	P	P	P	P
6	17E31A0107	BOLLAM VIJAY KUMAR	P	A	P	P	P	P	P	P	P	P
7	17E31A0108	CHELUMALLA VIKAS REDDY	P	P	P	P	A	P	P	P	P	P
8	17E31A0109	CHENNAKESHI MANIKANTA MUDHIRAJ	A	P	P	A	P	A	P	P	P	P
9	17E31A0110	D TEJA	P	P	P	A	P	P	P	P	P	P
10	17E31A0115	DEVALLA SMARANI	A	P	P	P	P	P	P	P	P	P
11	17E31A0116	HALAVATHI HARI KRISHNA	P	P	P	P	A	P	P	P	P	P



Institute of Science & Technology
 Department of Civil Engineering
 Hyderabad
 Date: 21/8/2019

12	17E31A0 121	MA QULAN UDDIN	P	P	P	P	P	P	P	P	P	P	P	P	P	P	P	P	P	P	P
13	17E31A0 122	MA DDELA ARUN KUMAR	P	P	P	P	A	P	P	P	P	P	P	P	P	P	P	P	P	P	P
14	17E31A0 125	MOHAMMED MUQTAR PATEL	A	A	P	P	P	P	P	P	P	P	P	P	P	P	P	P	P	P	P
15	17E31A0 128	MOHD MAJEED UDDIN	P	P	P	P	P	P	A	P	P	P	P	P	P	P	P	P	P	P	P
16	17E31A0 135	PAKALA SAI PRASAD	P	P	A	P	P	P	P	P	P	P	P	P	P	P	P	P	P	P	P
17	17E31A0 138	SILARAVATHI SREE DHIER	A	P	P	P	P	P	P	P	P	P	P	P	P	P	P	P	P	P	P
18	17E31A0 139	SHIVARATRI KUMAR	P	P	P	P	A	P	P	P	P	P	P	P	P	P	P	P	P	P	P
19	17E31A0 140	SHDDAMSETHI AVINASHI	A	P	P	P	P	P	P	P	P	P	P	P	A	P	P	P	P	P	P
20	17E31A0 141	SS REEIMATHIBABA	P	P	P	P	P	P	A	P	P	P	P	P	P	P	P	P	P	P	P
21	17E31A0 142	SUNKARA HARSHAVARDHAN	A	P	A	P	P	P	P	P	P	P	P	P	P	P	P	P	P	P	P
22	17E31A0 143	LURUKA PAVANI	P	P	P	P	P	P	P	P	P	P	P	P	P	P	P	P	P	P	P
23	17E31A0 144	YATHAM SAI VASHASWINI	A	P	P	P	P	P	P	P	P	P	P	P	P	P	P	P	P	P	P
24	18E35A0 101	ADAN ABDEL WASEF	P	P	P	P	A	P	P	P	P	P	P	P	A	P	P	P	P	P	P
25	18E35A0 102	HADALA VARA PRASAD	P	P	P	P	P	P	P	P	P	P	P	P	P	A	P	P	P	P	P



REVISION



26	18E25A0100	DONTHARABOINA KIRAN KUMAR	P	P	P	P	P	P	P	P	P	P	P	P	P	P	P	P	P	P
27	18E25A0106	KOLLA KRANTHI KUMAR	P	P	P	P	P	P	P	P	P	P	P	P	P	P	P	P	P	P
28	18E25A0107	MANKA TUSHAL YADAV	P	P	P	P	P	P	P	P	P	P	P	P	P	P	P	P	P	P
29	18E25A0108	MERUGU ROHITHI	P	P	P	P	P	P	P	P	P	P	P	P	P	P	P	P	P	P
30	18E25A0109	MULLU KUNTALA MOUNIKA	P	P	P	P	P	P	P	P	P	P	P	P	P	P	P	P	P	P
31	18E25A0110	POCHAGARI ALOK	P	P	P	P	P	P	P	P	P	P	P	P	P	P	P	P	P	P
32	18E25A0111	P DEEPA SREE	A	P	P	P	P	P	P	P	P	P	P	P	P	P	P	P	P	P
33	18E25A0112	PRAGHAVENDAR	P	P	P	P	P	P	P	P	P	P	P	P	P	P	P	P	P	P
34	18E25A0113	SANDADI ILLASWINI	P	P	P	P	P	P	P	P	P	P	P	P	P	P	P	P	P	P
35	18E25A0114	UPATHALLI VENUGOPAL	P	P	P	P	P	P	P	P	P	P	P	P	P	P	P	P	P	P
36	17E11A0102	ABUBAKAR	P	P	P	P	P	P	P	P	P	P	P	P	P	P	P	P	P	P
37	17E11A0119	MOHAMMED ALTHAF	P	P	P	P	P	P	P	P	P	P	P	P	P	P	P	P	P	P
38	17E11A0130	MOHAMMED HASMIM SIDANAN	P	P	P	P	P	P	P	P	P	P	P	P	P	P	P	P	P	P
39	18E25A0102	ABHINAV GAJANAN	P	P	P	P	P	P	P	P	P	P	P	P	P	P	P	P	P	P

Handwritten signature

MAHARAJA ENGINEERING COLLEGE
MADURAI

Vysapuri, Bandlaguda Post:Keshavgi,
Hyderabad-500 005, Telangana INDIA
Tel: 040-64596979,20020773, Fax: 040-24455003
E-mail: principal.mahaveer@gmail.com,
Website: www.mist.ac.in,

MAHAVEER
INSTITUTE OF SCIENCE & TECHNOLOGY
Approved by AICTE, Affiliated to JNTUH,Hyd.



DEPARTMENT OF CIVIL ENGINEERING

Technical Training Exam on Etabs Software

[A.Y-2019-20]

2x10=20 Marks

Answer All the Questions

1) Design of composite steel using etabs

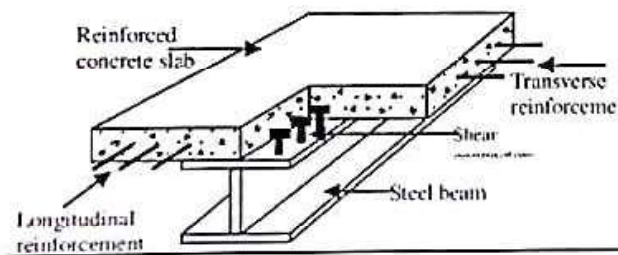

2) composite coloum using etabs

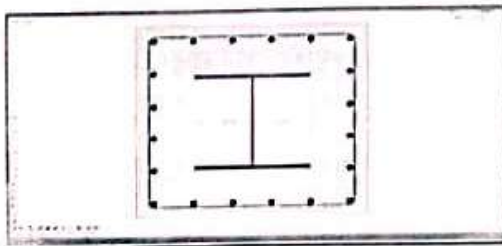

Kishu

PRINCIPAL
MAHAVEER
INSTITUTE OF SCIENCE & TECHNOLOGY
Bandlaguda, Hyderabad, J-500 005.



Vysapuri, Bandlaguda Post:Keshavgirl,
Hyderabad-500 005, Telangana INDIA
Tel: 040-64596979,20020773,, Fax: 040-24455003
E-mail: principal.mahaveer@gmail.com,
Website: www.mist.ac.in,

MAHAVEER
INSTITUTE OF SCIENCES & TECHNOLOGY
Approved by AICTE, Affiliated to JNTUH,Hyd.



DEPARTMENT OF CIVIL ENGINEERING

ETABS Technical Training student Marks list 2019-20

Sl.NO	Hall Ticket No	Name of the Candidate	YEAR	MARKS	PASS/I
1	17E31A0101	ANNALDASJANAKI	III	16	PASS
2	17E31A0102	ARSHIFIRDAUSH	III	16	PASS
3	17E31A0103	BSOHANLAL	III	12	PASS
4	17E31A0105	BHUKYARAJU	III	12	PASS
5	17E31A0106	BHUKYARAVIKUMAR	III	16	PASS
6	17E31A0107	BOLLAMVIJAYKUMAR	III	16	PASS
7	17E31A0108	CHELUMALLAVIKASREDDY	III	16	PASS
8	17E31A0109	CHENNAKESHIMANIKANTAMUDHIRAJ	III	16	PASS
9	17E31A0110	DTEJA	III	16	PASS
10	17E31A0113	DEVALLASMARANI	III	16	PASS
11	17E31A0116	HALAVATHIHARIKRISHNA	III	16	PASS
12	17E31A0121	MAGHANIUDDIN	III	16	PASS
13	17E31A0122	MADDELAARUNKUMAR	III	16	PASS
14	17E31A0125	MOHAMMEDMUQTARPATEL	III	16	PASS
15	17E31A0128	MOHIDMAJEEUDDIN	III	16	PASS
16	17E31A0135	PAKALASAIPRASAD	III	16	PASS
17	17E31A0138	SHARAVATHISREEDHER	III	16	PASS
18	17E31A0139	SHIVARATRINKUMAR	III	16	PASS

Kbuly
PRINCIPAL
MAHAVEER
INSTITUTE OF SCIENCES & TECHNOLOGY
Hyderabad-500 005

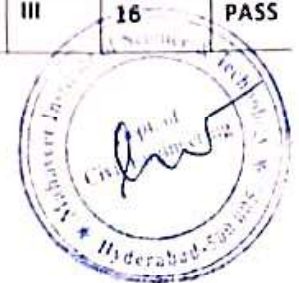

Vysapuri, Bandlaguda Post:Keshavgiri,
Hyderabad-500 005, Telangana INDIA
Tel: 040-6459979,2002073, Fax: 040-24455003
E-mail: principal.mahaveer@gmail.com,
Website: www.mist.ac.in,

MAHAVEER

INSTITUTE OF SCIENCE & TECHNOLOGY
Approved by AICTE, Affiliated to JNTUH,Hyd.



19	17E31A0140	SIDDAMSETTI VINASH	III	15	PASS
20	17E31A0141	SKREIMATHIBABA	III	16	PASS
21	17E31A0142	SUNKARAHARSHAVARDHAN	III	16	PASS
22	17E31A0143	TURUKAPAVANI	III	15	PASS
23	17E31A0144	YATHAMSAIYASHASWINI	III	16	PASS
24	18E35A0101	ADNANABDULWASE	III	14	PASS
25	18E35A0102	BADALAVARAPRASAD	III	15	PASS
26	18E35A0105	DONTHARABOINAKIRANKUMAR	III	15	PASS
27	18E35A0106	KOLLAKRANTHIKUMAR	III	16	PASS
28	18E35A0107	MANKATUSHALYADAV	III	14	PASS
29	18E35A0108	MERUGUROHITHI	III	16	PASS
30	18E35A0109	MULLUKUNTLAMOUNIKA	III	15	PASS
31	18E35A0110	POCHAGARIALOK	III	14	PASS
32	18E35A0111	PDEEPASREE	III	18	PASS
33	18E35A0112	PRAGHAVENDAR	III	15	PASS
34	18E35A0113	SANDADITEJASWINI	III	16	PASS
35	18E35A0114	UPUTHJALLIVENUGOPAL	III	15	PASS
36	17H11A0102	ABUBAKAR	III	14	PASS
37	17H11A0118	MOHAMMEDALTHAF	III	18	PASS
38	17H11A0119	MOHAMMEDASIMADNAN	III	15	PASS
39	15E31A0102	ABDULGAFFAR	III	16	PASS
40	19E38A0101	GOTTIMUKKALAVENKATAABHIGYANSILARMA	III	15	PASS

K. Srinivas
PRINCIPAL
MAHAVEER
INSTITUTE OF SCIENCE & TECHNOLOGY
Bandlaguda, Hyd-500 005.

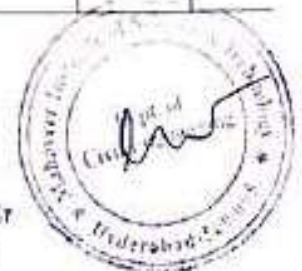

Vysapuri, Bandlaguda Post:Keshavgiri,
Hyderabad-509 005, Telangana INDIA
Tel: 040-64596979,20020773, Fax: 040-24455003
E mail: principal.mahaveer@gmail.com,
Website: www.mist.ac.in,

MAHAVEER

INSTITUTE OF SCIENCE & TECHNOLOGY

Approved by AICTE, Affiliated to JNTUH Hyd.



DEPARTMENT OF CIVIL ENGINEERING

Etabs course

Summary

- Use ETABS for daily working process.
- Navigate throughout ETABS using major navigating tools.
- Understand the concept and techniques to draw.
- Create multiple designs using several of tools.
- Create layers to control the objects' visibility.
- Explain drawing using annotations.
- To use constraint for certain design.

K. Srinivas

PRINCIPAL
MAHAVEER
INSTITUTE OF SCIENCE & TECHNOLOGY
BANDLAGUDA, HYDERABAD



Vysapuri, Bandlaguda Post:Keshavgi, Hyderabad-500 005, Telangana INDIA
Tel: 040-64598979,20020773, Fax: 040-24455003
E-mail: principal.mahaveer@gmail.com,
Website: www.mistlac.in,

MAHAVEER

INSTITUTE OF SCIENCE & TECHNOLOGY
Approved by AICTE, Affiliated to JNTUH,Hyd.



CERTIFICATE OF COURSE COMPLETION

This certificate is presented to _____ of MIST, who has successfully completed technical training course on "ETABS" held from _____ to _____ and found the student performance to be excellent.



ESTD : 2001

CH.SWETHAMBER

HOD

Civil Department



K. S. S. S.

PRINCIPAL
MAHAVEER

INSTITUTE OF SCIENCE & TECHNOLOGY
Bandlaguda, Post:500005,

Vyasapuri, Bandlaguda Post, Keshavnagar,

MAHAVEER



Hyderabad-500 005, TELANGANA INDIA
Tel: 040-64556979, 8978380692 Fax: 040-24455903
E-mail: g3hod_eee@gmail.com
Website: www.mistlac.in

INSTITUTE OF SCIENCE & TECHNOLOGY
Approved by AICTE. Affiliated to JNTUH, Hyd.

DEPARTMENT OF ELECTRICAL & ELECTRONICS

Date: 13-08-2019

To
The Principal,
Mist,
Hyderabad.

Sub-Proposal for Add on course-Reg.

Respected sir,

We are going to conduct two weeks workshop on **Mat lab Programming**. We require your approval to go head for further proceeding and hope to get an opportunity to serve you the best.
With thanks and regards

HOD-EEE

Professor & Head

Dept. of Electrical & Electronics Engg
Mahaveer Institute of Science & Technology
Vyasapuri, Bandlaguda, Keshavnagar,
Hyderabad - 500 005.

PRINCIPAL
MAHAVEER
INSTITUTE OF SCIENCE & TECHNOLOGY
Bandlaguda, Hyd-500 005.

Vysapuri, Bandlaguda Post: Keshavgi, Hyderabad-500 005, TELANGANA INDIA

MAHAVEER



Tel: 040-64596979, 8978380692 Fax: 040-24455003
E-mail: e3hod.eee@gmail.com,
Website: www.mist.ac.in,

Approved by AICTE, Affiliated to JNTUH, Hyd

DEPARTMENT OF ELECTRICAL & ELECTRONICS

Date: 13-08-2019

CIRCULAR

Technical Trainings for III B. Tech students are starting from **13-08-2019** onwards. All HODs and placements coordinators have to manage the trainings and ensure 95% attendance all through the sessions.

All mentors need to send the compiled feedback report to HOD at e3hod.eee@gmail.com daily. Mentors are advised to take care of PNR (Students not participating in training).

Agenda: **MATLAB PROGRAMMING**

Design & Development of Curriculum for Add on Courses Faculty Names 1. Dr M Sudakaran
2. G.Prem kumar Reddy

PRINCIPAL
MAHAVEER
INSTITUTE OF SCIENCE & TECHNOLOGY
Bandlaguda, Hyd-500 005.

HOD-EEE
Dept. of Electrical & Electronics Engg
Mahaveer Institute of Science & Technology
Vysapuri, Bandlaguda, Keshavgi,
Hyderabad - 500 005.

Vysapuri, Bandlaguda Post:Keshavgiri,

MAHAVEER



Hyderabad-500 005, TELANGANA INDIA

Tel: 040-64596979,8978380692 Fax: 040-24455003

E-mail: g3hod.eee@gmail.com.

Website: www.mist.ac.in.

Approved by AICTE. Affiliated to JNTUH,Hyd.

DEPARTMENT OF ELECTRICAL & ELECTRONICS

SYLLABUS FOR MATLAB PROGRAMMING

SNO	TOPIC COVERED	DERATION
1	Introduction	3
2	MATLAB API (Application Program Interface)	3
3	MATLAB working environment	3
4	Simulink	3
5	Root finding	3
6	Vectorization	3
7	Fractals&chaos	6
8	Debugging with matlab	6

HOD-EEE

Professor & Head
Dept. of Electrical & Electronics
Mahaveer Institute of Science & Technology
Vysapuri, Bandlaguda, Keshavgiri,
Hyderabad - 500 005.

PRINCIPAL
MAHAVEER
INSTITUTE OF SCIENCE & TECHNOLOGY
Bandlaguda, Hyd-500 005.

**DEPARTMENT OF ELECTRICAL & ELECTRONICS****LIST OF REGISTERED STUDENTS FOR MATLAB PROGRAMMING**

SNO	HALL TICKET NO	NAME OF THE STUDENT
1	17E31A0201	A S OM SAI KIRAN
2	17E31A0202	ANUPA VIKRAM
3	17E31A0203	APAKA ARAVIND
4	17E31A0204	BADAM RAHUL
5	17E31A0205	BHUKYA YASHWANTH
6	17E31A0206	BODDU HARIKRISHNA
7	17E31A0207	CHIDUMULA APARNA
8	17E31A0208	GADILA SAI KIRAN
9	17E31A0209	GAJALA SAI SREEYA
10	17E31A0210	GONEGANDLA KIRANKUMAR
11	17E31A0211	GULLA SRILATHA
12	17E31A0212	KATTA SANDEEP
13	17E31A0213	KARUMURI VENKATA RAMA DATTA ADITYA
14	17E31A0215	KELOTH SANTOSH
15	17E31A0216	KODELA VINEETH
16	17E31A0217	KONGARI PAVAN KUMAR
17	17E31A0218	LAKAVATH RAVI
18	17E31A0219	MALKAGIRI RAKESH
19	17E31A0220	MALLEPALLY SREE CHANDANA
20	17E31A0221	MASIREDDY VEERA REDDY
21	17E31A0223	SHAIK NAZEEMPASHA
22	17E31A0224	SIRISHETTI SHASHANK
23	17E31A0225	SYED ZAFAR
24	17E31A0226	THAKKALAPELLY RAKSHITHA
25	17E31A0227	THIMMAPURAM SUSHMA
26	17E31A0230	VANDELATHI HARI
27	18E35A0201	AJAY BABU M
28	18E35A0202	ANANTHULA MARUTHI
29	18E35A0203	HANDARU ANUSHA
30	18E35A0204	BAKARAPU NAVYA
31	18E35A0205	BOJJA VAISHNAVI
32	18E35A0206	BURA SRIDHAR
33	18E35A0207	DUMPALA SWETHA
34	18E35A0208	G JAY SHIVA
35	18E35A0209	KORRA SINDHU
36	18E35A0210	KUNARAPU SANDEEP
37	18E35A0211	M PRANITHA
38	18E35A0212	MADDELA NAVEEN GOLD
39	18E35A0213	MANCHOJU VENU
40	18E35A0214	PEDDASAYANNAGARU MAHENDAR REDDY

Vysapuri, Bandlaguda Post Keshavgi,

MAHAVEER



Hyderabad-500 005, TELANGANA INDIA

Tel: 040-64596979, 8978380692 Fax: 040-24455903

E-mail: ejhod.eee@gmail.com,

Website: www.mist.ac.in.

Approved by AICTE. Affiliated to JNTUH, Hyd

DEPARTMENT OF ELECTRICAL & ELECTRONICS

41	18E35A0215	RATHAVATH SINDU
42	18E35A0216	SINGANAMONI NAVANEETHA
43	18E35A0217	TANGELLA DERGA PAWAN KALYAN
44	18E35A0218	UPPULA ANIL KUMAR
45	16E31A0216	M RAGHAVENDER GOUD
46	16E31A0217	M DANISH PERWEZ

K. Subh

PRINCIPAL
MAHAVEER
INSTITUTE OF SCIENCE & TECHNOLOGY
Bandlaguda, Hyderabad-500 005.

H. Sampath

Professor & Head
Dept. of Electrical & Electronics Engg
Mahaveer Institute of Science & Technology
Vysapuri, Bandlaguda, Keshavgi,
Hyderabad - 500 005.

Vysaruni, Bandlaguda Post, Keshavnagar,

MAHAVEER



Hyderabad-500 005, TELANGANA INDIA
Tel: 040-64596979, 8978380692, Fax: 040-24455003
E-mail: ejhod.eee@gmail.com,
Website: www.mist.ac.in

Approved by AICTE, Affiliated to JNTUH, Hyd.

DEPARTMENT OF ELECTRICAL & ELECTRONICS

MATLAB PROGRAMMING QUESTION PAPER

Duration: 120 Minutes

4 X 5 = 20 Marks

Answer the following all questions. Each question carries 5 marks.

- 1) What is MATLAB?
- 2) Explain MATLAB API (Application Program Interface)?
- 3) What is The MATLAB working environment?
- 4) What is Simulink?

PRINCIPAL
MAHAVEER
INSTITUTE OF SCIENCE & TECHNOLOGY
Bandlaguda, Hyd-500 005.

HOD-EEE

Professor & Head
Dept. of Electrical & Electronics
Mahaveer Institute of Science & Tech
Vysaruni, Bandlaguda, Keshavnagar,
Hyderabad - 500 005.

**DEPARTMENT OF ELECTRICAL & ELECTRONICS****RESULT SHEET FOR MATLAB PROGRAMMING REGISTERED STUDENTS**

SSO	HALL TICKET NO	NAME OF THE STUDENT	MARKS (20)	RESULT
1	17E31A0201	A SOM SAI KIRAN	20	PASS
2	17E31A0202	ANUPA VIKRAM	19	PASS
3	17E31A0203	APAKA ARAVIND	20	PASS
4	17E31A0204	BADAM RAHUL	18	PASS
5	17E31A0205	BHUKYA YASHWANTH	20	PASS
6	17E31A0206	BODDU HARIKRISHNA	20	PASS
7	17E31A0207	CHIDUMULA APARNA	16	PASS
8	17E31A0208	GADILA SAI KIRAN	20	PASS
9	17E31A0209	GAJALA SAI SREEYA	20	PASS
10	17E31A0210	GONEGANDLA KIRANKUMAR	17	PASS
11	17E31A0211	GULLA SRILATHA	20	PASS
12	17E31A0212	KAITHA SANDEEP	20	PASS
13	17E31A0213	KARUMURI VENKATA RAMA DATTA ADITYA	16	PASS
14	17E31A0215	KELOTH SANTOSH	20	PASS
15	17E31A0216	KODELA VINEETH	20	PASS
16	17E31A0217	KONGARI PAVAN KUMAR	18	PASS
17	17E31A0218	LAKAVATH RAVI	20	PASS
18	17E31A0219	MALKAGIRI RAKESH	19	PASS
19	17E31A0220	MALLEPALLY SREE CHANDANA	20	PASS
20	17E31A0221	MASIREDDY VEERA REDDY	18	PASS
21	17E31A0223	SHAIK NAZEEMPASHA	20	PASS
22	17E31A0224	SIRISHETTI SHASHANK	20	PASS
23	17E31A0225	SYED ZAFAR	16	PASS
24	17E31A0226	THAKKAL APPELLY RAKSHITHA	20	PASS
25	17E31A0227	THIMMAPURAM SUSHMA	20	PASS
26	17E31A0230	VANKULURU HARJ	20	PASS
27	18E35A0201	AJAY BABU M	18	PASS
28	18E35A0202	ANANTHULA MARUTHI	20	PASS
29	18E35A0203	BANDARI ANISHA	19	PASS
30	18E35A0204	BAKARAPU NAVYA	20	PASS
31	18E35A0205	BOJJA VAISHNAVI	18	PASS
32	18E35A0206	BURA SRIDHAR	20	PASS
33	18E35A0207	DUMPALA SWETHA	20	PASS
34	18E35A0208	G JAY SHIVA	16	PASS
35	18E35A0209	KORRA SINDHU	20	PASS
36	18E35A0210	KUNARAPU SANDEEP	20	PASS
37	18E35A0211	M PRANTHA	17	PASS
38	18E35A0212	MADDELA NAVEEN GOUD	20	PASS
39	18E35A0213	MANCHOJU VENU	20	PASS

K. K. K.

Vysapuri, Bandlaguda Post/Keshavnagar,

MAHAVEER



Hyderabad-500 005, TELANGANA INDIA

Tel: 040-84286973,8978380882 Fax: 040-24455003

E-mail: ejhod.ven@gmail.com

Website: www.mist.ac.in

Approved by AICTE, Affiliated to JNTU(H),Hyd

DEPARTMENT OF ELECTRICAL & ELECTRONICS

40	18E35A0214	PEDDASAYANNAGARI MAHENDAR REDDY	16	PASS
41	18E35A0215	RATLAVATH SINDU	20	PASS
42	18E35A0216	SINGANAMONI NAVANEETHA	20	PASS
43	18E35A0217	TANGELLA DURGA PAWAN KALYAN	18	PASS
44	18E35A0218	UPPULA ANIL KUMAR	20	PASS
45	16E31A0216	M RAGHAVENDER GOUD	19	PASS
46	16E31A0217	M DANISH PERWEZ	20	PASS

No. of students Registered:46

No. of students Passed:46

No. of students failed:Nil.

PRINCIPAL
MAHAVEER
INSTITUTE OF SCIENCE & TECHNOLOGY
Bandlaguda, Hyd-500 005.

Professor & Head

Dept. of Electrical & Electronics En.,
Mahaveer Institute of Science & Techno
Vysapuri, Bandlaguda, Keshavnagar,
Hyderabad - 500 005.



DEPARTMENT OF ELECTRICAL & ELECTRONICS

SUMMARY REPORT OF MATLAB PROGRAMMING

This course site is the result of several iterations of an introductory course I have given at MIT, the last of which was called DR. MATLAB. In that course I strived to change the usual pattern of teaching/learning MATLAB from a programming view point to a mathematical one. The idea is that by thinking about mathematical problems, students are prodded into learning MATLAB for the purpose of solving the problem at hand. The down-side to this approach is that it is somewhat based on the idea that people are already excited about mathematics, or can be excited about it. That said, as I taught the course at MIT, it was not a big problem. Variables, arrays, conditional statements, loops, functions, and plots are covered in a project-based style where much of the learning happens away from the classroom. Students are expected to spend about 4 hours per week on homework. At the end of the course, students should be able to use MATLAB in their own work, and be prepared to deepen their MATLAB programming skills and tackle other languages for computing, such as Java, C++, or Python.

Copy to:

1. Department Notice Board
2. Principal for Information
3. Committee Members (Academic)

COORDINATOR

K. Venkatesh

PRINCIPAL
MAHAVEER
INSTITUTE OF SCIENCE & TECHNOLOGY
Bandlaguda, Hyd-500 005.

MAHAVEER

MAHAVEER SOCIETY'S TECHNICAL COLLEGE
Approved by AICTE, affiliated to JNTU, Hyderabad



A Two week certificate course

**On
"Mat Lab Programming"**



**Resource Person:
C.HARINATH
REDDY,GPREG**

**Scheduled From 23rd sep
to 7th October, 2019**

Timings: 10:00am to 12:00pm
Organized By
Department of
EEE,Engineering

Who can participate
All Engineering Faculty, Research Scholars and
Industrial Persons

(E-certificates will be issued to all
the participants, who submit feedback forms.)

Organized Committee:

Chairpersons:

Smt.S.Jayalaxmi, Chairman

Sri S. Surender Reddy, Secretary

Sri S. Dharmasri Reddy, Joint Secretary

Patron:

Dr.K.S.S.N.Reddy, Principal

Academic Advisor:

Dr.H.S.N.Murthy, Director

Convener:

Mr. P.V.V. Satyanarayana, & HOD, Dept. of
EEE Engineering

Co-Conveners: (contact for details)

1.Mr. P.V.V. Satyanarayana, Professor

2.Mrs. N.Saravathi -Assistant Professor

Programs Coordinators:

1.Mr.G.Premkumar Reddy -Assistant Professor

2.Mr. B.Saritha - Assistant Professor

3.Mrs. G.Jyothi -Assistant Professor

4.Mr.A.Mahesh Kumar -Assistant Professor

5.Mrs.K.S.Bhargavi -Assistant Professor

Contact Details:

Feel free to ask your queries to our faculty E-

Mail: ee3hodreg@jntu.ac.in / Laboratory Contact -

9966411762, 9989844063.

About the College:

Mahaveer Institute of Science & Technology (MIST) established in the year 2001 by

Mahaveer Education Society MIST offering 80 UG programs,

6 PG programs, and 5 Diploma courses. As an institute committed to quality education, MIST is not

providing learning with technology.

Two critical aspects of preparation for success in new work place are Education and Training, so that

you will have the required knowledge, skills and a high level of self-

motivation including initiative and responsibility.

About the department:

The Department of Electrical & Electronics Engineering was established in 2001 which offers B.Tech. and M.Tech. (POWER Engineering and Energy Systems) courses with highly qualified, dedicated and motivated faculty. The courses and programmes offered by the department are up to date, technical expertise to the students has also given a professional impetus.

Topics to be covered:

Day 1: Introduction

Day 2: MATLAB API (Application Program Interface)

Day 3: MATLAB working environment

Day 4: Standins

Day 5: Root finding

Day 6: Vectorization

Day 7: Fractals & chaos

Day 8: Fractals & chaos

Day 9: Debugging with matlab

Day 10: Debugging with matlab

About the FDP:

◆ This course is the result of several iterations of a survey program. The course I have given at MIT, the last year, of which has been evaluated by DR. MATLAB. In that course I strove to change the usual pattern of teaching/learning MATLAB from a programming view point to a mathematical one. The idea is that by thinking about mathematical problems, students are provided with learning MATLAB for the purpose of solving the problem at hand. The downside to this approach is that it is somewhat based on the idea that people are already excited about mathematics, or can be excited about it. That said, as I taught the course at MIT, it was not a big problem.

Harini

PHINCE

MAHAVEER INSTITUTE OF SCIENCE AND TECHNOLOGY

(Affiliated to JNTUH, Hyderabad and Approved by AICTE, New Delhi)
Vyasapuri, Bandlaguda, Post: Keshavagiri, Hyderabad- 500005



ESTD : 2001

organized by

Department of Electrical and Electronics Engineering

CERTIFICATE

This is certify that **Badam Rahul** bearing Hall Ticket No **17E31A02**
B.Tech Third Year has Participated in **MAT LAB Programming Tr.**
Program From **13-09-2019** to **27-09-2019** organized by Department
Electrical and Electronics Engineering.

HOD

P.V.V.Satyanarayana

C.Harinath Reddy

GPREC

PRINCIPAL

Dr.K.S.S.S.N

Vysapur, Bandlaguda Post Keshavnagar

MAHAVEER



Hyderabad 500 005, TELANGANA INDIA
Tel: 040-64596979, 8978380692 Fax: 040-24455903
E-mail: e3hod.eee@gmail.com
Website: www.msi.ac.in

Approved by AICTE Affiliated to JNTU(Hydr)

DEPARTMENT OF ELECTRICAL & ELECTRONICS

Date: 03/07/2020

To
The Principal
Mst
Hyderabad

Sub Proposal for Add on course Reg.

Respected Sir,

We are going to conduct two weeks workshop on **PSPICE Programming**. We require your approval to go ahead for further proceeding and hope to get an opportunity to serve you the best. With thanks and regards.

HOD-EEE

PRINCIPAL
MAHAVEER

INSTITUTE OF SCIENCE & TECHNOLOGY
Bandlaguda, Hyd-500 005

DR. P. S. S. S.

Professor

Department of Electrical & Electronics

MAHAVEER INSTITUTE OF SCIENCE & TECHNOLOGY

(Vysapur), Bandlaguda, Post Keshavnagar

Hyderabad - 500 005



DEPARTMENT OF ELECTRICAL & ELECTRONICS

Date: 07-02-2020

CIRCULAR

Technical Trainings for II - B Tech students are starting from 15-02-2020 onwards. All HODs and placements coordinators have to manage the trainings and ensure 95% attendance all through the sessions.

All mentors need to send the compiled feedback report to HOD at e3hod.eee@gmail.com daily. Mentors are advised to take care of PNR (Students not participating in training).

Agenda: **PSPICE programming**

Design & Development of Curriculum for Add on Courses Faculty Names: 1. Dr. M. Rajendar Reddy
2. P. V. V. SATYA NARAYANA

PRINCIPAL
MAHAVEER
INSTITUTE OF SCIENCE & TECHNOLOGY
Bandlaguda, Hyd-500 005

DR. M. RAJENDAR REDDY,
HOD-EEE
Prof. & Head
Dept. of Electrical & Electronics Engg.
Mahaveer Institute of Science & Techno-
logy, Vysapur, Bandlaguda, Keshavnagar,
Hyderabad-500 005

Vysapuri Bandlaguda Post Keshavnagar

MAHAVEER



Hyderabad-500 005, TELANGANA INDIA

Tel: 040-64596979, 8978380692 Fax: 040-24455003

E-mail: e3hod.eee@gmail.com

Website: www.misl.ac.in

Approved by AICTE. Affiliated to JNTUH Hyd

DEPARTMENT OF ELECTRICAL & ELECTRONICS

SYLLABUS FOR PSPICE programming

SNO	TOPIC COVERED	DURATION
1	Introduction	3
2	floating node error in pspice	3
3	simulate a three phase voltage source	3
4	simulate the FPAA mapping of analog circuit	3
5	gain loop of a flyback converter for compensation	3
6	Bias Point Analysis	3
7	DC Sweep Analysis	3
8	AC Sweep Analysis	3
9	Transient Analysis	3
10	Modelling Applications	3

[Signature]
HOD-EEE

[Signature]
MAHAVEER
INSTITUTE OF SCIENCE & TECHNOLOGY
Bandlaguda, Hyd-500 005.

HARSHODY HOD

Principal & Head

Department of Electrical & Electronics Engineering

Institute of Science & Technology

Vysapuri Bandlaguda, Keshavnagar

Hyderabad-500 005

Vysapur, Bandlaguda Post, Keshavnagar,

MAHAVEER



Hyderabad-500 005, TELANGANA INDIA

Tel: 040-64596979, 8978380692 Fax: 040-24455903

E-mail: e3hod.eee@gmail.com

Website: www.mist.ac.in

Approved by AICTE, Affiliated to JNTU(Hydr)

DEPARTMENT OF ELECTRICAL & ELECTRONICS

LIST OF REGISTERED STUDENTS FOR PSPICE programming

SNO	BALL TICKET NO	NAME OF THE STUDENT
1	19E31A0201	AARE BHARGAV KUMAR
2	19E31A0202	AKULA RAKESH
3	19E31A0204	BATHULA NAVIEN
4	19E31A0205	BHUKYA PRAVEEN KUMAR
5	19E31A0207	GANDHAM DEEPAK
6	19E31A0208	GANDRA DEEKSHITH RAO
7	19E31A0209	GUGULOTH JASWANTH NAIK
8	19E31A0210	GUGULOTHU PRAVEENA
9	19E31A0211	GUNI GANTI SPOORTHI
10	19E31A0212	KANKANALASA KUMAR
11	19E31A0213	KOWTIKWAR BAJRANG
12	19E31A0214	LINGAMPALLY MANOJ RAO
13	19E31A0215	MARINE NAVIEN
14	19E31A0216	MOGILI MANJULA
15	19E31A0217	MORAM DANUSH REDDY
16	19E31A0218	MUKKUGANESH REDDY
17	19E31A0219	NALLA RAHUL
18	19E31A0220	T DEEPTHI
19	19E31A0221	UPPANTHULA SANJAY
20	19E31A0222	VELI NURI RAJ
21	19E31A0223	VENNAMPETTI SANDEEP
22	18E31A0218	S DEEPAK KUMAR
23	18E31A0205	HAIKAR JEEVAN
24	16E31A0216	MAHILVARAGOVENDER GOUD
25	20E35A0201	CHITRA SURESH KUMAR
26	20E35A0203	EMMADEKAVURI
27	20E35A0204	GODHAPATI VIREDDY
28	20E35A0205	G SHIVANI
29	20E35A0206	GANDHAM SAI KIRAN
30	20E35A0207	KAILASAPU PRINCHANDU
31	20E35A0208	KODIGANTI PRABHAS
32	20E35A0209	PATHAKUNTA HARUN
33	20E35A0210	SUNITHRA KUNAL PRASAD
34	20E35A0211	Y VISHAL

Kishu

PRINCIPAL
MAHAVEER
INSTITUTE OF TECHNOLOGY
BANDLAGUDA, HYDRABAD



DEPARTMENT OF ELECTRICAL & ELECTRONICS

PSPICE programming Certification QUESTION PAPER

Duration: 120 Minutes

4 X 5 = 20 Marks

Answer the following all questions. Each question carries 5 marks.

- 1 How can fix the floating node error in pspice?
- 2 How to simulate a three phase voltage source in orcad capture?
- 3 What is the purpose to simulate the FPAA mapping of analog circuit?
- 4 How do to get gain loop of a flyback converter for compensation?

HOD-EEE



PRINCIPAL
MAHAVEER
INSTITUTE OF SCIENCE & TECHNOLOGY
Bandlaguda, Hyd-500 005.

RAJENDAR REDDY,
Professor & Head
Dept. of Electrical & Electronics
Maveer Institute of Science & Tech
Vysapuri, Bandlaguda, Keshavgin
Hyderabad - 500 005

**DEPARTMENT OF ELECTRICAL & ELECTRONICS****RESULT SHEET FOR PSPICE programming Certification REGISTERED STUDENTS**

SNO	HALL TICKET NO	NAME OF THE STUDENT	MARKS (20)	RESULT
1	19E 31 A0201	AARI BHARGAV KUMAR	20	PASS
2	19E 31 A0202	AKULA RAKESH	19	PASS
3	19E 31 A0203	BATHULA NAVEEN	20	PASS
4	19E 31 A0205	BHUKYA PRAVEEN KUMAR	18	PASS
5	19E 31 A0207	GANDHAM DEEPAK	20	PASS
6	19E 31 A0208	GANDRA DEEKSITH RAO	20	PASS
7	19E 31 A0209	GU GULOTHU JASWANATH NAIK	16	PASS
8	19E 31 A0210	GU GULOTHU PRAVEENA	20	PASS
9	19E 31 A0211	GUNUGANTI SPOORTHI	20	PASS
10	19E 31 A0212	KANKANALA SAIKUMAR	17	PASS
11	19E 31 A0213	KOWTHIKWAR BAIRANG	20	PASS
12	19E 31 A0214	LINGAMPALLY MANOJ RAO	20	PASS
13	19E 31 A0215	MARINE NAVEEN	16	PASS
14	19E 31 A0216	MOGHI MANJULA	20	PASS
15	19E 31 A0217	MORAM DANISH REDDY	20	PASS
16	19E 31 A0218	MUKKU GANESH REDDY	18	PASS
17	19E 31 A0219	NALLA RAHUL	20	PASS
18	19E 31 A0220	EDDEPITHI	19	PASS
19	19E 31 A0221	UPPANTHULA SANJAY	20	PASS
20	19E 31 A0222	VEMUNUR RAJU	18	PASS
21	19E 31 A0223	VENNAMPETTI SANDEEP	20	PASS
22	18E 31 A0218	S DEEPAK KUMAR	20	PASS
23	18E 31 A0205	HATKAR JEEVAN	16	PASS
24	16E 31 A0216	MAVILLA RAGHAVENDER GOUD	20	PASS
25	90E 35 A0201	AKARAPU SATHISH	19	PASS
26	90E 35 A0202	YANDHAKSINI SETHI	20	PASS
27	90E 35 A0203	GADDE PRADIP SURESH	20	PASS
28	90E 35 A0205	G SHIVANI	20	PASS
29	90E 35 A0206	G SUDHANSU SAIKIRAN	16	PASS
30	90E 35 A0207	KAMMASAPU PREMA CHANDU	20	PASS
31	90E 35 A0208	KODIGANTI PRABHAS	20	PASS
32	90E 35 A0209	PATRAKUNTA DHARUN	17	PASS
33	90E 35 A0210	SUNDIRA KUNAL PRASAD	20	PASS
34	90E 35 A0211	Y VISHAJ	20	PASS

No. of students Registered: 35

No. of students Passed: 35

No. of students failed: NIL

MAHAVEER
 INSTITUTE OF SCIENCE & TECHNOLOGY
 Bandlaguda, Hyd-500 005.

M. M. RAJENDAR REDDY,
 Professor & Head
 Department of Electrical & Electronics Engg.
 Institute of Science & Technology
 Bandlaguda, Bandlaguda Post, Keshavnagar
 Hyderabad - 500 005.

Vysapuri, Bandlaguda Post: Keshavgiri,

MAHAVEER



Hyderabad-500 005, TELANGANA INDIA

Tel: 040-64596979, 8978380692 Fax: 040-24455003

E-mail: e3hod.eee@gmail.com

Website: www.mist.ac.in

Approved by AICTE. Affiliated to JNTUH, Hyd

DEPARTMENT OF ELECTRICAL & ELECTRONICS

SUMMARY REPORT OF PSPICE programming Certification

PSPICE is a circuit analysis tool that allows the user to simulate a circuit and extract key voltages and currents. Information is entered into PSPICE via one of two methods, they are a typed 'Net List' or by designing a visual a schematic which is transformed into a netlist. In this class we will look at both the net list and the schematics. However, to to fully utilize the schematics we must first understand and become familiar with designing the net list.

COORDINATOR

Copy to

1. Department Notice Board
2. Principal for Information
3. Committee Members / Academic





A Two Week Certificate Course

On
"PSPICE PROGRAMMING"



Scheduled From
15th Feb to 7th Mar-2020
Timings: 10 Am to 12 Pm

ORGANIZED BY
Department of
Electrical & Electronics Engineering

Who can participate
All Engineering Faculty, Research
Scholars and Industrial Persons

Free Registration at:
<https://forms.gle/SP66JH9K5Ugmgq8>
(E-certificates will be issued to all the
participants who submit feedback forms)

Platform: GoToMeetings
Chief Patrons:
Smt. S. Jayalakshmi, Chairman

Sri S. Surender Reddy Secretary
Sri S. Dharmas Reddy Joint Secretary

Patron:
Dr. K. S. S. S. N. Reddy, Principal

Academic Adviser:
Dr. H. S. N. Murthy, Director

Convener:
Dr. M. Rajendar Reddy, Professor &
HOD, Dept. of EEE, M.I.S.T.

Mob: 9966441176,2
Email id: e3hod.eee.a@gmail.com

Co-Conveners:
1. Mr. G. Prem Kumar Reddy -Assoe Prof
Mob: 8309846628

2. Dr. M. Sudhakarun-Asst Professor
Mob: 9369263663

Program Coordinators:
1. Ms. R.Kalyani-Asst Professor
Mob: 8555838525

2. Mrs. N. Saraswathi-Asst Professor
Mob: 8008478516

3. Mr. A. Mahesh Kumar -Asst Professor
Mob: 998840617

4. Mrs. Jyothir Ma -Asst. Professor
Mob: 8125543368

About the College:
Our Institute committed to quality
education. MIST aims at providing
learning with a technology edge. Right
from its inception in 2001, it has turning
itself to meet this objective. It endeavors
to provide consistent training to the

students to help them evolve as competent
professionals in the highly competitive
world.

About the Department:
The Department of E.E.E. is working with a
mission to contribute through excellence in
technical education, with research
orientation. It imparts ethical & moral
values to the student's so as to make them
emerge as responsible professionals. With
its experienced faculty members having
excellent academic backgrounds, it trains
students supplementing classroom lectures
with computer aided demonstrations making
their learning a rich and rewarding
experience.

Resource person:
G.Srinivas, VITS

About the course:
PSPICE is a circuit analysis tool that allows the
user to simulate a circuit and extract key
voltages and currents. Information is entered
into PSPICE via one of two methods: they are a
typed Net List or by designing a visual
schematic which is transformed into a netlist. In
this class we will look at both the net list and the
schematics. However, it is facts about the
schematics we must first understand and
become familiar with designing the net list.

MAHAVEER INSTITUTE OF SCIENCE AND TECHNOLOGY

(Affiliated to JNTUH, Hyderabad and Approved by AICTE, New Delhi)
Vyasapuri, Bandlaguda, Post: Keshavagiri, Hyderabad- 500005



ESTD - 2001

organized by
Department of Electrical and Electronics Engineering

CERTIFICATE

This is certify that **Gunuganti Spoorthi** bearing Hall Ticket No 19E31.
of **B.Tech Second Year** has Participated in **PSPICE Programming T**
Program From 15-02-2020 to 28-02-2020 organized by Department
Electrical and Electronics Engineering.

HOD

Dr. M. Rajendar Reddy

G. Srinivas

VITS

PRINCIP

Dr. K. S. S. S.

6 Paper: Programming 2-31

SNO	ROLL NO	NAME OF THE STUDENT	1	2	3	4	5	6	7	8	9	10	11	12	13	14	15	16	17	18	19	20	21	22	23	24	25	26	27	28	29	30
1	19F31A0201	AARF BIHARGVA	P	P	P	P	P	P	P	P	P	P	P	P	P	P	P	P	P	P	P	P	P	P	P	P	P	P	P	P	P	
2	19F31A0202	AKULA RAKESH	P	P	P	P	P	P	P	P	P	P	P	P	P	P	P	P	P	P	P	P	P	P	P	P	P	P	P	P	P	
3	19F31A0204	BATHULA NAVIEN	P	P	P	P	P	P	P	P	P	P	P	P	P	P	P	P	P	P	P	P	P	P	P	P	P	P	P	P	P	
4	19F31A0205	BHUKYA PRAVEEN	P	P	P	P	P	P	P	P	P	P	P	P	P	P	P	P	P	P	P	P	P	P	P	P	P	P	P	P	P	
5	19F31A0207	GANDHAM DEEPAK	P	P	P	P	P	P	P	P	P	P	P	P	P	P	P	P	P	P	P	P	P	P	P	P	P	P	P	P	P	
6	19F31A0208	GANDRA DEEKSHITHI	P	P	P	P	P	P	P	P	P	P	P	P	P	P	P	P	P	P	P	P	P	P	P	P	P	P	P	P	P	
7	19F31A0209	GUGULOTH JASWANIDI	P	P	P	P	P	P	P	P	P	P	P	P	P	P	P	P	P	P	P	P	P	P	P	P	P	P	P	P	P	
8	19F31A0210	GUGULOTHU	P	P	P	P	P	P	P	P	P	P	P	P	P	P	P	P	P	P	P	P	P	P	P	P	P	P	P	P	P	
9	19F31A0211	GUNUGANTI SRIKRISHNA	P	P	P	P	P	P	P	P	P	P	P	P	P	P	P	P	P	P	P	P	P	P	P	P	P	P	P	P	P	
10	19F31A0212	KANKANATA	P	P	P	P	P	P	P	P	P	P	P	P	P	P	P	P	P	P	P	P	P	P	P	P	P	P	P	P	P	
11	19F31A0213	KOWTIKWAR BAJRANG	P	P	P	P	P	P	P	P	P	P	P	P	P	P	P	P	P	P	P	P	P	P	P	P	P	P	P	P	P	
12	19F31A0214	LINGAMPALLY MANI	P	P	P	P	P	P	P	P	P	P	P	P	P	P	P	P	P	P	P	P	P	P	P	P	P	P	P	P	P	
13	19F31A0215	MARINE NAVIEN	P	P	P	P	P	P	P	P	P	P	P	P	P	P	P	P	P	P	P	P	P	P	P	P	P	P	P	P	P	
14	19F31A0216	MOGILI MANJULA	P	P	P	P	P	P	P	P	P	P	P	P	P	P	P	P	P	P	P	P	P	P	P	P	P	P	P	P	P	
15	19F31A0217	MORAMDANI SHI	P	P	P	P	P	P	P	P	P	P	P	P	P	P	P	P	P	P	P	P	P	P	P	P	P	P	P	P	P	
16	19F31A0218	MURKUGANESH	P	P	P	P	P	P	P	P	P	P	P	P	P	P	P	P	P	P	P	P	P	P	P	P	P	P	P	P	P	
17	19F31A0219	NALLA RAHUL	P	P	P	P	P	P	P	P	P	P	P	P	P	P	P	P	P	P	P	P	P	P	P	P	P	P	P	P	P	
18	19F31A0220	T DEEPTHI	P	P	P	P	P	P	P	P	P	P	P	P	P	P	P	P	P	P	P	P	P	P	P	P	P	P	P	P	P	
19	19F31A0221	UPPANTHILJA	P	P	P	P	P	P	P	P	P	P	P	P	P	P	P	P	P	P	P	P	P	P	P	P	P	P	P	P	P	
20	19F31A0222	VENUSURIAH	P	P	P	P	P	P	P	P	P	P	P	P	P	P	P	P	P	P	P	P	P	P	P	P	P	P	P	P	P	
21	19F31A0223	VENNAMPETTI	P	P	P	P	P	P	P	P	P	P	P	P	P	P	P	P	P	P	P	P	P	P	P	P	P	P	P	P	P	
22	19F31A0218	S DEEPAK KUMAR	P	P	P	P	P	P	P	P	P	P	P	P	P	P	P	P	P	P	P	P	P	P	P	P	P	P	P	P	P	
23	19F31A0205	HATKAR JEEVAN	P	P	P	P	P	P	P	P	P	P	P	P	P	P	P	P	P	P	P	P	P	P	P	P	P	P	P	P	P	
24	19F31A0216	MAVILLA	P	P	P	P	P	P	P	P	P	P	P	P	P	P	P	P	P	P	P	P	P	P	P	P	P	P	P	P	P	
25	20F35A0201	AKARAPU SATISHI	P	P	P	P	P	P	P	P	P	P	P	P	P	P	P	P	P	P	P	P	P	P	P	P	P	P	P	P	P	
26	20F35A0202	ANANDESH SAINATHI	P	P	P	P	P	P	P	P	P	P	P	P	P	P	P	P	P	P	P	P	P	P	P	P	P	P	P	P	P	
27	20F35A0203	ANMADI KAVRPI	P	P	P	P	P	P	P	P	P	P	P	P	P	P	P	P	P	P	P	P	P	P	P	P	P	P	P	P	P	
28	20F35A0204	BIHARGVA SRIJITHA	P	P	P	P	P	P	P	P	P	P	P	P	P	P	P	P	P	P	P	P	P	P	P	P	P	P	P	P	P	
29	20F35A0205	G SRIHANI	P	P	P	P	P	P	P	P	P	P	P	P	P	P	P	P	P	P	P	P	P	P	P	P	P	P	P	P	P	
30	20F35A0206	GANDHAM SRIKRISHNA	P	P	P	P	P	P	P	P	P	P	P	P	P	P	P	P	P	P	P	P	P	P	P	P	P	P	P	P	P	
31	20F35A0207	KALASAPU PREMA	P	P	P	P	P	P	P	P	P	P	P	P	P	P	P	P	P	P	P	P	P	P	P	P	P	P	P	P	P	
32	20F35A0208	KODURANTHAPPAHITHI	P	P	P	P	P	P	P	P	P	P	P	P	P	P	P	P	P	P	P	P	P	P	P	P	P	P	P	P	P	
33	20F35A0209	PATHEKUNTA LATHA	P	P	P	P	P	P	P	P	P	P	P	P	P	P	P	P	P	P	P	P	P	P	P	P	P	P	P	P	P	
34	20F35A0210	VAITHIRAKANAL	P	P	P	P	P	P	P	P	P	P	P	P	P	P	P	P	P	P	P	P	P	P	P	P	P	P	P	P	P	
35	20F35A0211	V VEMBA	P	P	P	P	P	P	P	P	P	P	P	P	P	P	P	P	P	P	P	P	P	P	P	P	P	P	P	P	P	

[Handwritten Signature]

About the College

As an Institute committed in quality education, MIST aims at providing learning with a Technology-edge. It endeavors to provide consistent training to its students to help them evolve as competent professionals in the highly competitive world. Right from its inception in 2001, it has been tuning itself to meet this objective. A new civilization is emerging in our lives. This civilization brings with it a new way of working. Millions are already tuning their lives to the rhythms of tomorrow.

About the Mechanical Department

The Mechanical engineering is one of the core engineering departments, which has potential to accommodate all efficient engineers. The Mechanical engineers serve all other branches of engineering directly or indirectly. The Mechanical engineers can find their place in Automobile engineering sector, Steel Plants, Power plants, Software industries, Manufacturing industries, Design industries, Military, Naval and Air force, Defense research organizations, Material research organizations etc.

About the Workshop

AutoCAD is globally used by surveyors, designers, engineers, drafters. Globally, AutoCAD has proven as an efficient and user-friendly Program. Program.Commercial drafting and computer-aided design(CAD) software applications are AutoCAD. AutoCAD software is recognized internationally for its remarkable editing capabilities, which make it likely to digitally draw building plans or recreate 3D images. AutoCAD is compatible with other applications like 3D Max. The designers can even import or export DWG & DXG Files to the application. Also, these files can even be exported from AutoCAD to other applications for creating more improved projects & presentations.

Organising committee

CHIEF PATRON

Smt. S. Jayalakshmi Reddy

Chairman

Sri. S. Surendar Reddy

Secretary

Sri S. Dhanunjay Reddy

Joint Secretary

DIRECTOR

Dr. H. S. N. Murthy

PATRON

Dr.K.S.S.Reddy, Principal

CONVENER

Dr.S.Murali,

Professor,Dept. Of Mechanical

PROGRAM COORDINATORS

K.Devi Singh

P.Praveen Kumar Reddy

Conducted On

01/5/2019- 13/5/2019



ETD - 2011

MAHAVEER
INSTITUTE OF SCIENCE & TECHNOLOGY

Approved by AICTE, Affiliated to JNTU, Hyderabad.
Visision, Bandipada, Text: Kapatagiri, Hyderabad-500065.



Two week
Certification Course
on

Auto CAD

Organized by

Department of Mechanical
Engineering

Vyasaiah, Bandlaguda Post, Kothagutta,
Hyderabad-505005, Telangana INDIA.
Tel: 040-64536979, 20929773, Fax: 040-21455603
E-mail: principal@mahaveer.org
Website: www.mahaveer.org

MAHAVEER



Approved by AICTE, Affiliated to JNTUH Hyderabad

Date: 29-04-2019

To
The Principal
MIST,
Hyderabad.

Sub: Proposal for Add-on Course-Reg.

Respected sir,

We are going to conduct 10 days Technical Training for II B. Tech students on "Introduction to Auto CAD". We require your approval to go head for proceeding and hope to get an opportunity to serve you the best.

With thanks and regards

Dr. S. Murali

HOD

Department of Mechanical Engineering

Kishu

MAHAVEER
BANDLAGUDA, HYD-505005

Vysakhari, Bandlaguda Post Keshavnagar,
Hyderabad 500 005, Telangana INDIA
Tel: 040-64596979, 20020773, Fax: 040-24455003
E-mail: principal.mahaveer@gmail.com
Website: www.mst.ac.in

MAHAVEER



Approved by AICTE. Affiliated to JNTU(H) Hyd

Date: 30.04.2019

CIRCULAR

Technical Training for H B. Tech students are starting from 1st MAY, 2019 onwards. All HODs and Placements coordinators have to manage the trainings and ensure 95% attendance all through the sessions.

All Mentors need to send the compiled feedback report to Dr.S.Murali, HOD at e3hod.mech@gmail.com daily.

Agenda: 1. Introduction to AUTOCAD.

Design and Development of curriculum for Add on course:

Name of the Faculty : K.Devi Singh

KESAVI

PRINCIPAL
MAHAVEER
INSTITUTE OF TECHNOLOGY
BANDLAGUDA POST, KESHAVNAGAR
HYDERABAD - 500 005

Dr.S.Murali

HOD

Department of Mechanical Engineering



Auto CAD SYLLABUS

1: Getting Started with AutoCAD

- Opening and Creating Drawings
- Exploring the AutoCAD interface
- Zooming and Panning

2: Basic Drawing & Editing Commands

- Using the Mouse, Keyboard, and Enter Key to work quickly and efficiently in AutoCAD
- Lines
- Circles
- Rectangles

3: Projects - Creating a Simple Drawing

- Creating Simple Drawings
- Using Object Snap Tracking to extrapolate a projected top view
- Using Modify tools to arrange an office layout

4: Drawing Precision in AutoCAD

- Polar and Ortho Tracking
- Entering Coordinates and Angles
- Object Snaps and Tracking

5: Making Changes in Your Drawing

- Move
- Copy
- Rotate
- Mirror
- Scale
- Using the reference option with the Scale Tool

7: Organizing Your Drawing with Layers

- Layer States
- Properties by Layer
- Layer Tools

8: Advanced Object Types

- Polylines
- Arcs

Kishor
Principal
Mahaveer Institute of Technology
Vysapur, Bandlaguda Post, Keshavnagar,
Hyderabad-500 003, Telangana, INDIA
Tel: 040-64596979, 20020773, Fax: 040-24455003
E-mail: principal.mahaveer@gmail.com
Website: www.mahaveer.ac.in



- Polygons
- Ellipses

9: Advanced Editing Commands

- Trim and Extend
- Fillet and Chamfer
- Polyline Edit and Spline
- Offset and Explode
- Join

10: Inserting Blocks

- The Insert Block Command
- Inserting Blocks with Tool Palettes
- Dynamic Blocs
- Migrating Blocks and other Elements between Drawings with Design Center

11: Text

- The Multiline Text Tool
- The Single Line Text Tool
- Editing Text
- Text in Model Space vs. Paper Space
- The Multileader Tool

12: Hatching

- The Hatch Command
- The Hatch Editor Ribbon Tab
- Saving and Applying Hatches with Tool Palettes

13: Adding Dimensions

- Using Dimensioning Tools
- Dimensioning in a Layout Tab vs. the Model Tab
- Using Dimension Styles
- Editing Dimensions

14: Projects - Annotating Your Drawing

- Dimensioning a Mechanical Drawing





Department of Mechanical Engineering Auto CAD Technical Training student attendance list 2019-20

S.NO.	ROLL NO.	NAME OF THE STUDENT	YEAR
1	18E31A0301	B ABHILASH CHARY	II
2	18E31A0302	BANOTHU DIVYA	II
3	18E31A0304	CHAKKALA RAJNATH SIMHA	II
4	18E31A0305	GADDALA JAGADISH BIARAT KUMAR	II
5	18E31A0307	JANGA SAIKRISHNA	II
6	18E31A0308	JARIBANDA SAI RAMREDDY	II
7	18E31A0309	KASTHURI ARUN KUMAR	II
8	18E31A0314	MIRZA QUSRO BAIG	II
9	18E31A0322	MOHD ABDUL JUNAID	II
10	18E31A0323	MOHD AZHARUDDIN	II
11	18E31A0324	MOHD FAZAL	II
12	18E31A0325	MUJTABA AHMED	II
13	18E31A0326	P CHAITANYA	II
14	18E31A0327	PATHI ABHINAV	II
15	18E31A0328	PATHI ABHINAV	II
16	18E31A0329	PEDININTI SURAJ KUMAR	II
17	18E31A0330	PENDYALA RANJEETH KUMAR	II
18	18E31A0331	SADHU THRUJITH	II
19	18E31A0332	SAHADEVUDU BALAJI	II
20	18E31A0333	SANTHAPURI PHALGUN	II
21	18E31A0334	SUNKI REDDY RUTHVIK REDDY	II
22	18E31A0335	VALLALA SAIKRISHNA	II

Kishu
Principal
MAHAVEER
INSTITUTE OF TECHNOLOGY
BANDLAGUDA, HYD-500 095

Vysapuri, Bandlaguda Post Keshavnagar,
Hyderabad-500 005, Telangana (INDIA)
Tel: 040-64596979, 20020773, Fax: 040-24455063
E-mail: principal.mahaveer@gmail.com
Website: www.mst.ac.in

MAHAVEER



Approved by AICTE, Affiliated to JNTU-Hydr

23	18E31A0336	VEPURI PRASHANTH	II
24	18E31A0337	YOGESH PAWAN GUMMADI	II
25	19E35A0301	A SAI KUMAR	II
26	19E35A0303	CHANDAPAKA AJAYKUMAR	II
27	19E35A0304	DERESH CHANDRA DANIEL BULLA	II
28	19E35A0305	ENDARAPU MADHU	II
29	19E35A0306	GOVINDU DINESH REDDY	II
30	19E35A0307	MADDASANI SAI VIKAS	II
31	19E35A0308	SURVI RAKESH	II
32	19E35A0309	VANAPARTHI NIKHIL	II
33	19E35A0310	VEMULAPALLI GOPI	II
34	17D91A0306	CHUKKA PRADEEP	II
35	18D91A0302	AHMED FARAZUDDIN	II
36	18D91A0313	MD NASHEED AHMED	II
37	18D91A0326	SHUAIB ABDUL HAMEED	II
38	17M31A0307	MOHAMMED ABUDUL KHALID	II
39	17E31A0331	MOHAMMED MOAZZAM ALI	II
40	17E31A0335	MOHAMMED SAMEER MUNAWAR HUSSAIN	II
41	17H11A0303	HABIB SYED MUSTAFA	II
42	15D91A0383	N ARUN	II
43	16H11A0348	MOHAMMED BARIQ	II
44	16M31A0301	ABDUL NAYEEM	II
45	16M31A0304	AWADESH KUMAR	II
46	17E31A0307	CH KARTHIK REDDY	II
47	17E31A0312	GOLLA MADHUSUDHAN	II
48	17E31A0317	KARRE PRABHAKAR	II

Handwritten signature and date:
17/03/2024

Vysapark, Bandlaguda Post, Keshavnagar
Hyderabad-500 005, Telangana INDIA
Tel: 040-64596979, 20020773, Fax: 040-24435093
E-mail: principal.mahaveer@gmail.com
Website: www.mahaveer.in

MAHAVEER



Approved by AICTE. Affiliated to JNTU(Hydr)

49	17E31A0321	K SAI KUMAR	II
50	17E31A0323	MABIHSHEK	II
51	17E31A0332	MOHAMMED MUSAIB UDDIN	II
52	17E31A0336	MD ABDULAASEEM RAHIL	II
53	17E31A0347	SAAD BIN SIKANDER	II
54	17E31A0349	SHAIK ABDUL RAB	II
55	17E31A0350	SHAIK MOHD ZAKIR SHAMIM	II
56	17E31A0351	SHAIK SHAIIBAZ	II
57	17E31A0357	TEJAVATH LAXMAN	II
58	17E31A0359	VEMI REDDY VENUGOPAL REDDY	II
59	17E31A0361	YALAL VINAYAK REDDY	II
60	18E35A0320	MOHAMMAD KAIF UR ZAMA	II

K. S. S. S.
PRINCIPAL
MAHAVEER
DISTRICT COLLEGE
Bandlaguda, Hyd-500 005



Technical Training Exam on Auto CAD Software (A.Y-2017-18)

2x10=20 Marks

Answer All the Questions

1. Draw the given 2D model into 3D model by using Auto CAD

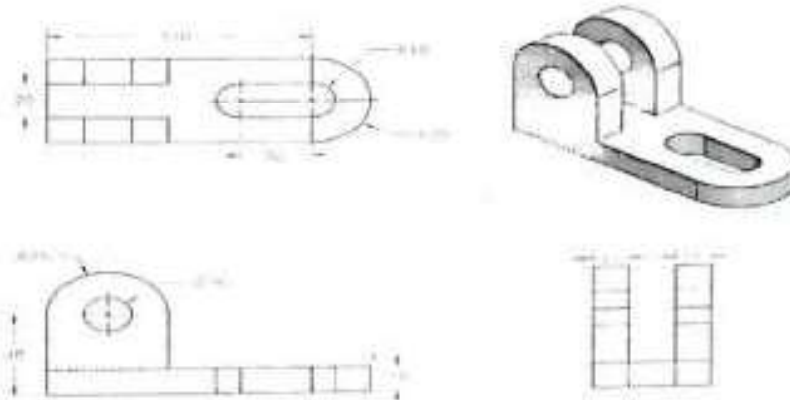

2. Draw the given 2D model into 3D model by using Auto CAD.

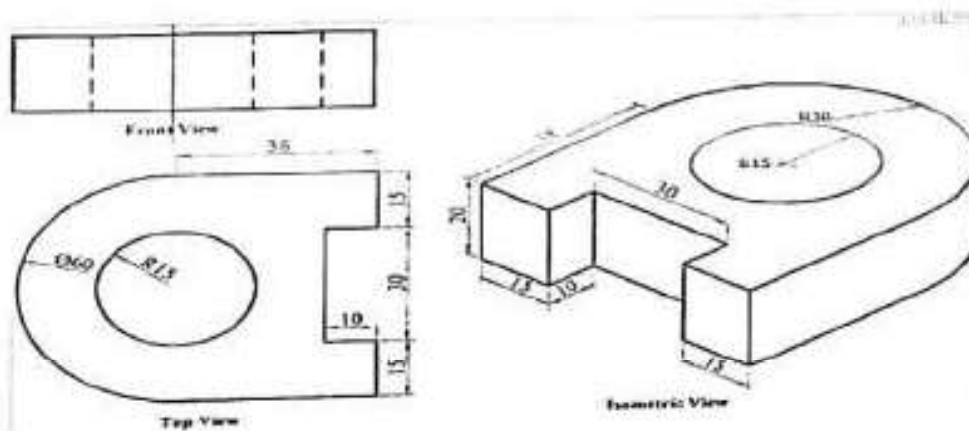

Kanhu
PRINCIPAL
MAHAVEER
VYSAKHARI, BANDLAGUDA POST
KESHAVNAGAR, HYDERABAD-500 035



Department of Mechanical Engineering
Auto CAD Technical Training student Marks list 2019-20

S.NO	Roll No	Name of the student	YEAR	MARKS	PASS/FAIL
1	18E31A0301	B ABHILASH CHARY	II	15	PASS
2	18E31A0302	BANOTHU DIVYA	II	16	PASS
3	18E31A0304	CHAKKALA RAJNATH SIMHA	II	14	PASS
4	18E31A0305	GADDALA JAGADISH BIHARAT KUMAR	II	15	PASS
5	18E31A0307	JANGA SAIKRISHNA	II	15	PASS
6	18E31A0308	JARIBANDA SAI RAMREDDY	II	14	PASS
7	18E31A0309	KASTHURI ARUN KUMAR	II	16	PASS
8	18E31A0314	MIRZA QUSRO BAIG	II	14	PASS
9	18E31A0322	MOHD ABDUL JUNAID	II	15	PASS
10	18E31A0323	MOHD AZHARUDDIN	II	15	PASS
11	18E31A0324	MOHD FAZAL	II	14	PASS
12	18E31A0325	MUJTABA AHMED	II	16	PASS
13	18E31A0326	P CHAITANYA	II	16	PASS
14	18E31A0327	PATHI ABHINAV	II	14	PASS
15	18E31A0328	PATHI ABHINAV	II	15	PASS
16	18E31A0329	PEDININTI SURAJ KUMAR	II	16	PASS
17	18E31A0330	PENDYALA RANJEETH KUMAR	II	15	PASS
18	18E31A0331	SADHU THRUJITH	II	16	PASS
19	18E31A0332	SAHADEVUDU BALAJI	II	14	PASS
20	18E31A0333	SANTHAPURI PHALGUN	II	16	PASS
21	18E31A0334	SUNKI REDDY RUTHVIK REDDY	II	14	PASS
22	18E31A0335	VALLALA SAIKRISHNA	II	15	PASS

(Handwritten signature)
Principal

23	18E31A0336	YI PURI PRASANTH	II	16	PASS
24	18E31A0337	YOGESH PAWAN GUJMADI	II	15	PASS
25	19E35A0301	A SAI KUMAR	II	16	PASS
26	19E35A0303	CHANDAPAKA AJAYKUMAR	II	14	PASS
27	19E35A0304	DERESH CHANDRA DANIEL HULLA	II	16	PASS
28	19E35A0305	ENDARAPU MADHU	II	14	PASS
29	19E35A0306	GOVINDU DINESH REDDY	II	15	PASS
30	19E35A0307	MADDASANI SAI VIKAS	II	15	PASS
31	19E35A0308	SURVI RAKESH	II	14	PASS
32	19E35A0309	VANAPARTHI NIKHIL	II	16	PASS
33	19E35A0310	DEMULAPALLI GOPI	II	16	PASS
34	17D91A0306	CHUKKA PRADEEP	II	14	PASS
35	18D91A0302	AHMED FARAZUDDIN	II	15	PASS
36	18D91A0313	MD NASHEED AHMED	II	16	PASS
37	18D91A0326	SHUAIB ABDUL HAMEED	II	15	PASS
38	17M31A0307	MOHAMMED ABUDUL KHALID	II	16	PASS
39	17E31A0331	MOHAMMED MOAZZAM ALI	II	14	PASS
40	17E31A0335	MOHAMMED SAMEER MUNAWAR HUSSAIN	II	12	PASS
41	17H11A0303	HABEEB SYED MUSTAFA	II	15	PASS
42	15D91A0383	N ARUN	II	16	PASS
43	16H11A0348	MOHAMMED BARIQ	II	14	PASS
44	16M31A0301	ABDUL NAYEM	II	15	PASS
45	16M31A0304	AWADESH KUMAR	II	16	PASS
46	17E31A0307	CH KARTHIK REDDY	II	15	PASS
47	17E31A0312	GOLLA MADHUSUDHAN	II	16	PASS
48	17E31A0317	KARRE PRABHAKAR	II	14	PASS
49	17E31A0321	K SAI KUMAR	II	12	PASS
50	17E31A0323	M ABHISHEK	II	15	PASS
51	17E31A0332	MOHAMMED MUSAIB UDDIN	II	16	PASS

Khalid

10/10/2020

10/10/2020

Vysaberi, Bandlaguda Post, Keshavnagar,
Hyderabad-500 005, Telangana, INDIA
Tel: 040-64596979, 30020773, Fax: 040-24465003
E-mail: principal.mahaveer@gmail.com,
Website: www.mist.ac.in.

MAHAVEER



Approved by AICTE, Affiliated to JNTUH Hyd

52	17E31A0336	MD ABDULAASEEM RAHIL	II	14	PASS
53	17E31A0347	SAAD BIN SIKANDER	II	15	PASS
54	17E31A0349	SHAIK ABDUL RAB	II	16	PASS
55	17E31A0350	SHAIK MOHD ZAKIR SHAMIM	II	15	PASS
56	17E31A0351	SHAIK SHAIBAZ	II	16	PASS
57	17E31A0357	TEJAVATH LAXMAN	II	14	PASS
58	17E31A0359	VEMI REDDY VENUGOPAL REDDY	II	12	PASS
59	17E31A0361	YALAL VINAYAK REDDY	II	15	PASS
60	18E35A0320	MOHAMMAD KAIF UR ZAMA	II	16	PASS

Principal
Mahaveer Institute of Technology & Research
Bandlaguda, Hyderabad-500 005.



Auto CAD COURSE Summary

Department of Mechanical Engineering

- Use AutoCAD for daily working process.
- Navigate throughout AutoCAD using major navigating tools.
- Understand the concept and techniques to draw.
- Create multiple designs using several of tools.
- Create layers to control the objects' visibility.
- Explain drawing using annotations.
- Plot or print the drawing by scale.
- To use constraint for certain design.

Copy to :

1. Department of Notice Board
2. Principal for Information
3. Committee Members (Academic)

Kanish
Principal
Department of Mechanical Engineering
Mahaveer Education Society
Hyderabad

Vysapudi, Bandlaguda Post Keshavnagar
Hyderabad-500 005, Telangana INDIA
Tel: 040-64896979, 20020771, Fax: 040-24458003
E-mail: principal@mahaveer@gmail.com
Website: www.mahaveer.ac.in

MAHAVEER



Approved by AICTE. Affiliated to JNTUH-Hydr.

CERTIFICATE OF COURSE COMPLETION

This certificate is presented to M. Sai vikas of
MIST, who has successfully completed technical training course on
"Auto CAD" held from 01-05-2019 to 13-05-2019 and found the
student performance to be excellent.



ESTD : 2001

Dr. S. Murali

HOD

Department of Mechanical Engineering



Faint text or stamp at the bottom of the page, possibly a date or reference number.

DEPARTMENT OF MECHANICAL ENGINEERING

List of students enrolled in Auto CAD (2019-2020)

S.No	Roll No	Name of the student	15/19/215	315	M15	615	715	815	915	1015	11519
1	18E31A0301	B ABHILASH CHARY	P	P	P	P	P	P	P	P	P
2	18E31A0302	BANOTHU DIVYA	P	P	P	P	P	P	P	P	P
3	18E31A0304	CHAKKALAKRASHI VITHI SIMHA	P	P	P	P	P	P	P	P	P
4	18E31A0305	GADDALA JAGADISH BHARAT KUMAR	P	P	P	P	P	P	P	P	P
5	18E31A0307	JANGA SAKRISHNA	P	P	P	P	P	P	P	P	P
6	18E31A0308	JARIBANDA SAI RAMREDDY	P	P	P	P	P	P	P	P	P
7	18E31A0309	KASTHURI ARUN KUMAR	P	P	P	P	P	P	P	P	P
8	18E31A0314	MIRZA QUSRO BATO	P	P	P	P	P	P	P	P	P
9	18E31A0322	MOHD ABDUL JUN AID	P	P	P	P	P	P	P	P	P
10	18E31A0323	MOHD AZHAR UDIN	P	P	P	P	P	P	P	P	P
11	18E31A0324	MOHD FAZAL	P	P	P	P	P	P	P	P	P

Kanishk

VEER

MAHAVEER
Engineering College
Banasthiguda, Hyderabad



DEPARTMENT OF MECHANICAL ENGINEERING

List of students enrolled in Auto CAD (2019-2020)

27	19E35A0304	DERESH CHANDRA DANIEL BULLA	P	P	P	P	P	P	P	P	P	P	P	P	P	P	P	P	P
28	19E35A0305	ENDARAPU MAJHI	P	P	P	P	P	P	P	P	P	P	P	P	P	P	P	P	P
29	19E35A0306	GOVINDU DINESH REDDY	P	P	P	P	P	P	P	P	P	P	P	P	P	P	P	P	P
30	19E35A0307	MADDASANI SAI YR KAS	P	P	P	P	P	P	P	P	P	P	P	P	P	P	P	P	P
31	19E35A0308	SURVI RAKESH	P	P	P	P	P	P	P	P	P	P	P	P	P	P	P	P	P
32	19E35A0309	VANAPARTHI NIKHIL	P	P	P	P	P	P	P	P	P	P	P	P	P	P	P	P	P
33	19E35A0310	VEMULAPALLI GOPI	P	P	P	P	P	P	P	P	P	P	P	P	P	P	P	P	P
34	17D91A0306	CHUKKA PRADEEP	P	P	P	P	P	P	P	P	P	P	P	P	P	P	P	P	P
35	18D91A0302	AHMED FARAZ UDDIN	P	P	P	P	P	P	P	P	P	P	P	P	P	P	P	P	P
36	18D91A0313	MID NASHIED AHMED	P	P	P	P	P	P	P	P	P	P	P	P	P	P	P	P	P
37	18D91A0326	SHUAIB ABDUL HAMIED	P	P	P	P	P	P	P	P	P	P	P	P	P	P	P	P	P
38	17M31A0307	MOHAMMED ABU DUL KHALID	P	P	P	P	P	P	P	P	P	P	P	P	P	P	P	P	P
39	17E31A0331	MOHAMMED MO VIZAM ALI	P	P	P	P	P	P	P	P	P	P	P	P	P	P	P	P	P

Handwritten signature

PRINCIPAL

MAHAVER

Hyderabad, Telangana

500 084



DEPARTMENT OF MECHANICAL ENGINEERING

List of students enrolled in Auto CAD (2019-2020)

40	17E31A0335	MOHAMMED SAMIUR MUNAWAR HUSSAN	P	P	P	P	P	P	P	P	P	P	P	P	P	P	P	P	P	P
41	17H1A0503	HABIB SYED MUSTAFA	P	P	P	P	P	P	P	P	P	P	P	P	P	P	P	P	P	P
42	15D91A0583	NARUN	P	P	P	P	P	P	P	P	P	P	P	P	P	P	P	P	P	P
43	16H1A0528	MOHAMMED RAYAN	P	P	P	P	P	P	P	P	P	P	P	P	P	P	P	P	P	P
44	16M31A0501	ABDUL NAYEEM	P	P	P	P	P	P	P	P	P	P	P	P	P	P	P	P	P	P
45	16M31A0504	AWADESH KUMAR	P	P	P	P	P	P	P	P	P	P	P	P	P	P	P	P	P	P
46	17E31A0307	CH. KARTHICK REDDY	P	P	P	P	P	P	P	P	P	P	P	P	P	P	P	P	P	P
47	17E31A0512	GOLLA MADHUSRI BHANU	P	P	P	P	P	P	P	P	P	P	P	P	P	P	P	P	P	P
48	17E31A0317	KARRE PRABHU VAR	P	P	P	P	P	P	P	P	P	P	P	P	P	P	P	P	P	P
49	17E31A0321	K SAI KUMAR	P	P	P	P	P	P	P	P	P	P	P	P	P	P	P	P	P	P
50	17E31A0323	M ABHISHEK	P	P	P	P	P	P	P	P	P	P	P	P	P	P	P	P	P	P
51	17E31A0332	MOHAMMED MASHAB UDDIN	P	P	P	P	P	P	P	P	P	P	P	P	P	P	P	P	P	P
52	17E31A0336	MD ABDULLA ASHRAF RAHIL	P	P	P	P	P	P	P	P	P	P	P	P	P	P	P	P	P	P

Abhishek

PRINCIPAL
 MACHA VEER
 VENKATESWARA COLLEGE OF ENGINEERING & TECHNOLOGY
 VENGAL RAO NAGAR, VENGAL RAO NAGAR



MAHAVEER
INSTITUTE OF SCIENCE & TECHNOLOGY

Approved by AICTE, attached to JNTU, Hyderabad.
Vyasaiahil, Bandlaguda, Post: Keesaripati, Hyderabad-500081.

Organizing committee

CHIEF PATRON

Smt. S. Jayalakshmi Reddy

Chairman

Sri. S. Surendar Reddy

Secretary

Sri S. Dhanunjay Reddy

Joint Secretary

DIRECTOR

Dr. H. S. N. Murthy

PATRON

Dr B. Nageshwar Rao.Principal

CONVENER

Dr.S.Murali

Professor, Dept. Of Mechanical

PROGRAM COORDINATORS

Mr.G.K.Shanmukh Dey

Duration

01/05/2019-13/5/2019

About the College

As an Institute committed in quality education, MIST aims at providing learning with a Technology-edge. It endeavors to provide consistent training to its students to help them evolve as competent professionals in the highly competitive world. Right from its inception in 2001, it has been tuning itself to meet this objective. A new civilization is emerging in our lives. This civilization brings with it a new way of working. Millions are already tuning their lives to the rhythms of tomorrow.

About Mechanical Dept.

The Mechanical engineering is one of the core engineering departments, which has potential to accommodate all efficient engineers. The Mechanical engineers serve all other branches of engineering directly or indirectly. The Mechanical engineers can find their place in Automobile engineering sector, Steel Plants, Power plants, Software industries, Manufacturing industries, Design industries, Military, Naval and Air force, Defense research organizations, Material research organizations etc.

About the Workshop

CATIA delivers the unique ability not only to model any product, but to do so in the context of its real-life behavior design in the age of experience. CATIA (Computer-Aided Three dimensional Interactive Application) software is a complete multi-platform solution for computer-aided design, manufacturing, engineering, 3D and PLM. Marketed by manufacturer Dassault Systemes, the software is ideal for creating solids, surfaces, assemblies, drawings, fabrication and analysis. However, CATIA offers more advanced functionality for surfaces and modules for different industries.



**Two week
Certification Course
on**

Introduction to CATIA

Organized by

**Department of Mechanical
Engineering**

Vidyanagar, Bandlaguda Puri, Keshavnagar,
Hyderabad-500 033, Telangana (A.C. R)
Tel: 040-64596919, 20020773, Fax: 040-24455003
E-mail: principal@mahaveer.org
Website: www.mist.ac.in

MAHAVEER



Approved by AICTE, Affiliated to JNTUH Hyd

Date: 29-04-2019

To
The Principal
MIST,
Hyderabad.

Sub: Proposal for Add-on Course-Reg.

Respected sir,

We are going to conduct 10 days Technical Training for II B. Tech students on "Introduction to catia". We require your approval to go head for proceeding and hope to get an opportunity to serve you the best.

With thanks and regards.

Dr.S.Murali

HOD

Department of Mechanical Engineering

PRINCIPAL
MAHAVEER
INSTITUTE OF TECHNOLOGY
BANDLAGUDA, HYD-500 033.



Date: 30.04.2019

CIRCULAR

Technical Training for III B. Tech students are starting from 1st MAY, 2019 onwards. All HODs and Placements coordinators have to manage the trainings and ensure 95% attendance all through the sessions.

All Mentors need to send the compiled feedback report to Dr.S.Murali, HOD .

Agenda:

1. Introduction to CATIA.

Design and Development of curriculum for Add on course:

Name of the Faculty : G.K.Shanmukh Dev

Kanhi
PRINCIPAL
MAHAVEER
INSTITUTE OF SCIENCE & TECHNOLOGY
BANDLAGUDA, HYD-500 005

Dr.S.Murali
Dr.S.Murali

HOD

Department of Mechanical Engineering



CATIA SYLLABUS

Total Hours: 30

I. Introduction:

- Modulus
- Features (powerful Tools
- Parametric modeling
- Feature based approach
- Parent – child Relationship)
- Associative and Model Centric
- b) Information about Interface
- Tools, Menu, etc.

II. Sketcher:

- Getting Started
- Interface
- Sketch tools
- Profiles
- Operations
- Constraints
- Sketcher preferences
- References

III. Part Features:

- **Sketch Based Features**
- Pad
- Pocket
- Thin
- Shaft
- Groove

Kishor
MAHAVEER
INSTITUTE OF TECHNOLOGY
WVJAM H. BHANDARI, PGD, SST, 040-2445969

- Hole
- Threaded Hole
- Rib
- Slot & Stiffener
- Multi section solid

IV. Dress-up Features

- Fillet
- Chamfer
- Draft
- Shell
- Thickness
- Thread/Tap

V. Reference Element

- Point
- Line
- Plane

VI. Assembly Modeling:

- Assembly Constraints
- Manipulation
- Defining a multi & fast multi-instantiation
- Analyzing an assembly

VII. Drafting:

- Sheets & Views
- View modification
- Generating dimensions
- Bill of material
- Dimensions
- Annotations
- Dress up Elements
- Properties
- Exporting and Importing files

Kishu
 PRINCIPAL
 MAHAVEER
 INSTITUTE OF SCIENCE & TECHNOLOGY
 Chittoor, Andhra Pradesh, 520 002



Department of Mechanical Engineering CATIA Technical Training student attendance list 2019-20

SL.NO.	ROLL NO.	NAME OF THE STUDENT	YEAR
1	17E31A0301	AILNENI HARSHITH	III
2	17E31A0302	ALLA RAJA	III
3	17E31A0304	BANGARI MOHAN	III
4	17E31A0305	BASANOLA JAYVARDHAN	III
5	17E31A0306	BEJJANKI MAHESH REDDY	III
6	17E31A0308	DANDU SANJEEV	III
7	17E31A0309	DEPA JAYANDER REDDY	III
8	17E31A0311	G ABHILASH REDDY	III
9	17E31A0313	GUGGILLA VENKAT SAI	III
10	17E31A0314	GUNNAM VENKATA LAKSHMI AKHILA	III
11	17E31A0316	KANNA MANIKANTA	III
12	17E31A0320	KONDURU PAVAN KUMAR	III
13	17E31A0322	M A GHOUSE	III
14	17E31A0324	MALLETHULA RAHUL	III
15	17E31A0325	MALLISETTI PREM SAI	III
16	17E31A0326	MANGILGI MAHESH	III
17	17E31A0327	MANKENA PRUDHIVIRAJ	III
18	17E31A0328	MD ARMAN	III
19	17E31A0333	MOHAMMED RAYEES	III
20	17E31A0339	NALLAMPALLY SRIKANTH REDDY	III
21	18E35A0301	AKULA GIRIDHAR YADAV	III
22	18E35A0302	AYIDALAPALLY SHYAM KUMAR	III
23	18E35A0303	B CHANDRA SEKHAR	III
24	18E35A0305	BASUDE SAGAR	III
25	18E35A0306	BOLLAM NARESH	III
26	18E35A0307	CH RAJU	III
27	18E35A0308	CHINNABOSKA MAHESH	III
28	18E35A0309	CHINNAPAGU SWETHA	III
29	18E35A0310	DODLA PRATHAP	III
30	18E35A0311	G UMA MAHESHWARI	III
31	18E35A0312	GOKA SAIKRISHNA	III
32	16M31A0322	TELUSRI AJAY	III

33	17M31A0306	SYED MOHAMMED FAIZAN GHORI	III
34	18M35A0308	MOHD FIRASATH ALI	III
35	16E31A0330	PUTTAPAD VADAIAH	III
36	17E35A0317	P TARUN KUMAR	III
37	16E31A0333	R HEMANTH KUMAR	III
38	17E31A0342	P BHARGAV KUMAR	III
39	17E31A0343	PILLI AKHIL BABU	III
40	17E31A0344	POLNENI SAITEJA	III
41	17E31A0346	RUDRARAJU DEEPANKAR SARAVANA VARMA	III
42	17E31A0348	SATHYAPRASAD POOJA	III
43	17E31A0352	SHAIKH FAIZAN RAZA	III
44	17E31A0354	SHARAVAN SUTHAR	III
45	17E31A0355	T BUNNY	III
46	17E31A0360	YADAMA SATHISH REDDY	III
47	18E35A0313	GUDA VIKAS	III
48	18E35A0314	JALUKURI RAM MURTHI	III
49	18E35A0315	KANDE VINEETH	III
50	18E35A0317	MADUGULA GOPALA KRISHNA	III
51	18E35A0318	MEGAVATH MAHIPAL	III
52	18E35A0321	NITIN MAHENDRAKAR	III
53	18E35A0322	NUNAVATH LINGAM	III
54	18E35A0323	RAPOLU SRIKANTH	III
55	18E35A0324	THOTLA MAHENDER	III
56	18E35A0325	V PRANEESH	III
57	16621A0316	SYED ABUBAKAR	III
58	17D91A0303	AMPALLY NITHIN KUMAR	III
59	17D91A0304	BAROOR ARVIND REDDY	III
60	17D91A0307	DESANI SANDEEP REDDY	III
61	17D91A0308	DIDDI ROSHAN SAI	III
62	17D91A0309	GOLKONDA NITHISH YADAV	III
63	17D91A0311	GUNTUKA RAMBABU	III
64	17D91A0316	MOHAMMAD IRFAN	III
65	17D91A0320	MULA SATHVIK REDDY	III
66	17D91A0324	SADUVULA DEVENDER	III
67	17D91A0325	SAMALLA DIVAKAR	III
68	17D91A0330	VODNALA ADITHYA	III
69	18D95A0301	BEERA PRAVEEN KUMAR	III
70	18D95A0303	GAJULA SANGEETH KUMAR	III
71	18D95A0305	M ASHWINKANTH	III
72	18D95A0306	MANDAPELLI SRIKANTH	III
73	18D95A0307	MOOD HATHIRAM	III
74	18D95A0310	SARE SRIKANTH	III
75	17E35A0307	K SURESH	III

Handwritten signature

2024-03-28
 10:10 AM
 10:10 AM



Technical Training Exam on Catia Software (A.Y-2019-2020)

2x10=20 Marks

Answer All the Questions

1. Draw the given figure by using Catia software.

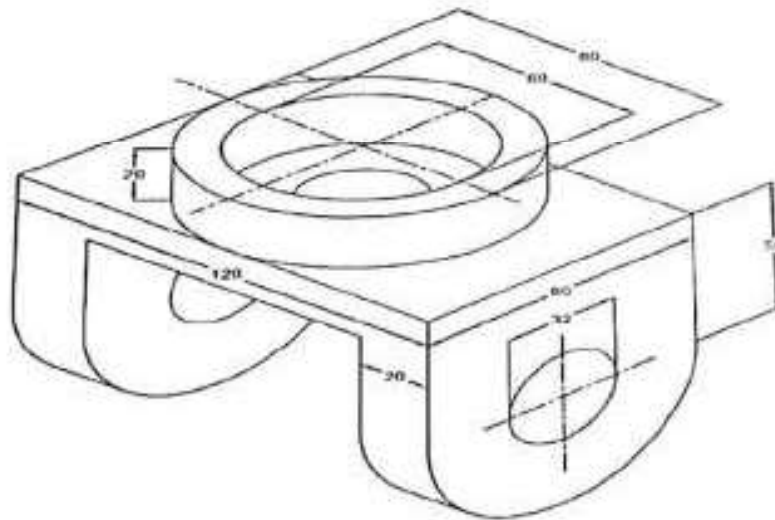

2. Draw the given 2D model into 3D model by using Catia.

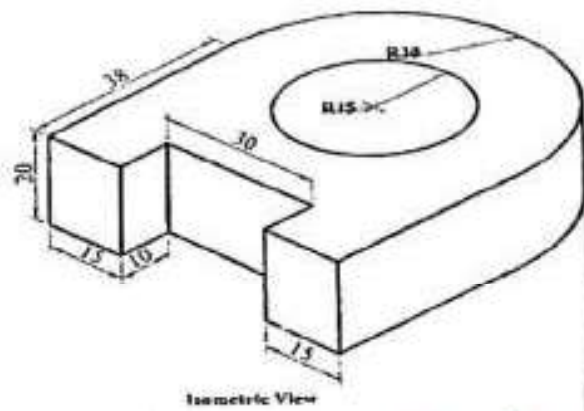
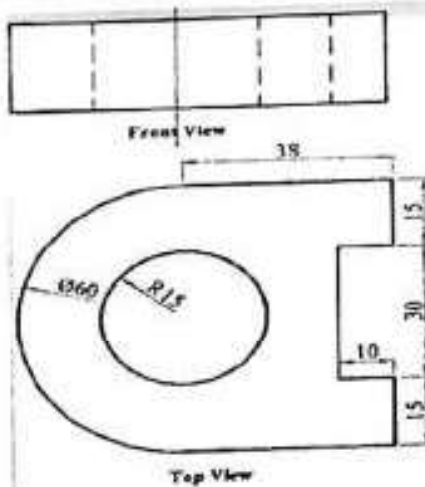



Department of Mechanical Engineering
CATIA Technical Training student attendance list 2019-20

S.NO	Roll No	Name of the student	YEAR	MARKS	PASS/FAIL
1	17E31A0301	AHNENI HARSHITH	III	14	PASS
2	17E31A0302	ALLA RAJA	III	15	PASS
3	17E31A0304	BANGARI MOHAN	III	17	PASS
4	17E31A0305	BASANOLA JAYVARDHAN	III	15	PASS
5	17E31A0306	BEJANKI MAHESH REDDY	III	16	PASS
6	17E31A0308	DANDU SANJEEV	III	16	PASS
7	17E31A0309	DEPA JAYANDER REDDY	III	15	PASS
8	17E31A0311	G ABHILASH REDDY	III	16	PASS
9	17E31A0313	GUGGILLA VENKAT SAI	III	12	PASS
10	17E31A0314	GUNNAM VENKATA LAKSHMI AKHILA	III	15	PASS
11	17E31A0316	KANNA MANIKANTA	III	16	PASS
12	17E31A0320	KONDURU PAVAN KUMAR	III	14	PASS
13	17E31A0322	M A GHOUSE	III	15	PASS
14	17E31A0324	MALLETHULA RAHUL	III	17	PASS
15	17E31A0325	MALLISETTI PREM SAI	III	15	PASS
16	17E31A0326	MANGILGI MAHESH	III	14	PASS
17	17E31A0327	MANKENA PRUDHVIRAJ	III	15	PASS
18	17E31A0328	MD ARMAN	III	17	PASS
19	17E31A0333	MOHAMMED RAYEES	III	15	PASS
20	17E31A0339	NALLAMPALLY SRIKANTH REDDY	III	16	PASS
21	18E35A0301	AKULA GIRIDHAR YADAV	III	16	PASS
22	18E35A0302	AYIDALAPALLY SUDHAKAR KUMAR	III	15	PASS
23	18E35A0303	B CHANDRA SEKHAR	III	16	PASS
24	18E35A0305	BASUDE SAGAR	III	12	PASS
25	18E35A0306	BOLLAM NARESH	III	15	PASS
26	18E35A0307	CH RAJU	III	16	PASS
27	18E35A0308	CHINNABOSKA MAHESH	III	14	PASS
28	18E35A0309	CHINNAPAGU SWETHA	III	15	PASS
29	18E35A0310	DODLA PRATHAP	III	17	PASS
30	18E35A0311	G UMA MAHESHWARI	III	15	PASS
31	18E35A0312	GOKA SAIKRISHNA	III	16	PASS

K. Srinivas
PRINCIPAL
MAHAVEER
INSTITUTE OF SCIENCE AND TECHNOLOGY



32	16M31A0322	H. USRI AJAY	III	16	PASS
33	17M31A0306	SYED MOHAMMED FAIZAN GHORI	III	16	PASS
34	18M35A0308	MOHD FIRASATTI ALI	III	16	PASS
35	16E31A0330	PUTTAPAD YADALAH	III	15	PASS
36	17E35A0317	P TARUN KUMAR	III	16	PASS
37	16E31A0333	R HEMANTH KUMAR	III	12	PASS
38	17E31A0342	P BHARGAV KUMAR	III	15	PASS
39	17E31A0343	PILLI AKHIL BABU	III	16	PASS
40	17E31A0344	POLNENI SAITEJA	III	14	PASS
41	17E31A0346	RUDRARAJU DEEPANKAR SARAVANA VARMA	III	15	PASS
42	17E31A0348	SATHYAPRASAD POOJA	III	17	PASS
43	17E31A0352	SHAIKH FAIZAN RAZA	III	15	PASS
44	17E31A0354	SHARAVAN SUTHAR	III	16	PASS
45	17E31A0355	T BUNNY	III	16	PASS
46	17E31A0360	YADAMA SATHISH REDDY	III	16	PASS
47	18E35A0313	GUDA VIKAS	III	15	PASS
48	18E35A0314	JALUKURI RAM MURTHI	III	16	PASS
49	18E35A0315	KANDE VINEETH	III	12	PASS
50	18E35A0317	MADUGULA GOPALA KRISHNA	III	15	PASS
51	18E35A0318	MEGAVATH MAHIPAL	III	16	PASS
52	18E35A0321	NITIN MAHENDRAKAR	III	14	PASS
53	18E35A0322	NUNAVATH LINGAM	III	15	PASS
54	18E35A0323	RAPOLU SRIKANTH	III	17	PASS
55	18E35A0324	THOTLA MAHENDER	III	15	PASS
56	18E35A0325	V PRANEESH	III	16	PASS
57	16621A0316	SYED ABUBAKAR	III	16	PASS
58	17D91A0303	AMPALLY JITHIN KUMAR	III	16	PASS
59	17D91A0304	BAROOR ARVIND REDDY	III	15	PASS
60	17D91A0307	DESANI SANDEEP REDDY	III	16	PASS
61	17D91A0308	DIDDI ROSHAN SAI	III	12	PASS
62	17D91A0309	GOLKONDA NITHISH YADAV	III	15	PASS
63	17D91A0311	GUNTUKA RAMBABU	III	16	PASS
64	17D91A0316	MOHAMMAD IRFAN	III	14	PASS
65	17D91A0320	MULA SATHVIK REDDY	III	15	PASS
66	17D91A0324	SADUVULA DEVENDER	III	17	PASS
67	17D91A0325	SAMALLA DIVAKAR	III	15	PASS
68	17D91A0330	VODNALA ADITHYA	III	16	PASS

Vysamuri, Bandlaguda Post, Keshavnagar,
Hyderabad-500 008, Telangana-50014
Tel: 040-64896979, 20820773, Fax: 040-24455083
E-mail: principal.mahaveer@gmail.com
Website: www.mim.ac.in

MAHAVEER



Approved by AICTE. Affiliated to JNTUH Hydr.

69	18D95A0301	BEERA PRAVEEN KUMAR	III	16	PASS
70	18D95A0303	GAJULA SANGEETHA KUMAR	III	15	PASS
71	18D95A0305	M ASHWIN KANTH	III	17	PASS
72	18D95A0306	MANDAPELLI SRIKANTH	III	15	PASS
73	18D95A0307	MOOD HATHIRAM	III	16	PASS
74	18D95A0310	SARE SRIKANTH	III	16	PASS
75	17E35A0307	K SURESH	III	16	PASS

K. Suresh

M
INSTITUTE

Keshavnagar



CATIA COURSE Summary

- In this course, you will learn how to utilize the core functionality enhancements in Catia.
- First, you will become familiar with using and customizing the new ribbon interface in Catia.
- The new measure and sectioning interfaces will also be examined. Next, you will become familiar with the Sketcher workflow and reference enhancements.
- Part modeling enhancements to features such as Extrude, Corner Chamfer, Sweeps, Blends, and Datum Curves will then be examined.
- You will also learn about new and enhanced Assembly capabilities, such as selecting multiple components, the new relationship constraints, and enhancements for dragging components.
- Then, you will examine the new Table and Balloon functionality for 2-D drawings, and review various detailing enhancements.
- At the end of each module, you will complete a set of review questions to reinforce critical topics from that module. At the end of the course, you will complete a course assessment in Catia intended to evaluate your understanding of the course as a whole.

Copy to :

1. Department of Notice Board
2. Principal for Information
3. Committee Members (Academic)

PRINCIPAL
MAHAVEER
INSTITUTE OF SCIENCE & TECHNOLOGY
Bandlaguda, Hyderabad-500 075.

Venkat, Bandlaguda Post, Keshavnagar,
Hyderabad-500 005, Telangana, INDIA
Tel: 040-64556979, 20020775, Fax: 040-24455003
E-mail: principal.mahaveer@gmail.com
Website: www.mist.ac.in

MAHAVEER



Approved by AICTE - Affiliated to JNTU(Hydr)

CERTIFICATE OF COURSE COMPLETION

This certificate is presented to G. Venkat Sai of
MIST, who has successfully completed technical training course on
"CATIA" held from 01-05-2019 to 13-05-2019 and found the
student performance to be excellent.

Kishu
PRINCIPAL
MAHAVEER
INSTITUTE OF SCIENCE & TECHNOLOGY
Bandlaguda, Hyd-500 005.



ESTD : 2001

Dr. S. Morali

HOD

Department of Mechanical Engineering

Vysavuri, Bhanupratheepa Point, Kuntur, 1500
 Hyderabad-500 305, T. No: 98481111
 Tel: 040-64500270, 20020775, Fax: 98481111
 E-mail: ppr@mahaveer.ac.in, mahaveer@mahaveer.ac.in
 Website: www.mahaveer.ac.in



MAHAVEER

APPROVED BY AICTE. AFFILIATED TO JNTUHYD

DEPARTMENT OF MECHANICAL ENGINEERING

List of students enrolled in CATIA (2019-2020)

S.No	Roll No	Name of the student	Date	15/05/20	16/05/20	17/05/20	18/05/20	19/05/20	20/05/20
1	17E31A0301	AINENI HARSHITH		P	P	P	P	P	P
2	17E31A0302	ALLA RAJA		P	P	P	P	P	P
3	17E31A0304	BANGARI MOHAN		P	P	P	P	P	P
4	17E31A0305	BASANOLA JAY ARDHAN		P	P	P	P	P	P
5	17E31A0306	BEDANKI MAHESH REDDY		P	P	P	P	P	P
6	17E31A0308	DANDU SANJEV		P	P	P	P	P	P
7	17E31A0309	DEPA JAYANDER REDDY		P	P	P	P	P	P
8	17E31A0311	G ABHILASH REDDY		P	P	P	P	P	P
9	17E31A0313	GUGGILLA VENKAT SAI		P	P	P	P	P	P
10	17E31A0314	G VENKATA LAKSHMI AKHILA		P	P	P	P	P	P
11	17E31A0316	KANNA MANIKANTA		P	P	P	P	P	P
12	17E31A0320	KONDURU PAVAN KUMAR		P	P	P	P	P	P

Handwritten signature and date
 20/05/2020



MAHAVEER

INSTITUTE OF SCIENCE & TECHNOLOGY

Approved by AICTE, Affiliated to JNTU, Hyderabad.

Venkatapuram, Bhanupur, Dist. West Godavari, Hyderabad-500003.

ESTD. 2001

Organising committee

CHIEF PATRON

Smt. S. Jayalakshmi Reddy

Chairman

Sri. S. Surendar Reddy

Secretary

Sri S. Dhanunjay Reddy

Joint Secretary

DIRECTOR

Dr. H. S. N. Murthy

PATRON

Dr. K.S.S.N Reddy, Principal

CONVENER

Dr.S.Murali

Professor, Dept. Of Mechanical

PROGRAM COORDINATORS

Mr. B.Venkateswar Reddy

Conducted On

1/5/2019- 13/5/2019

About the College

As an Institute committed in quality education, MIST aims at providing learning with a Technology-edge. It endeavors to provide consistent training to its students to help them evolve as competent professionals in the highly competitive world. Right from its inception in 2001, it has been tuning itself to meet this objective. A new civilization is emerging in our lives. This civilization belongs with a new way of working. Millions are already tuning their lives to the rhythms of tomorrow.

About the Mechanical Dept.

The Mechanical engineering is one of the core engineering departments, which has potential to accommodate all efficient engineers. The Mechanical engineers serve all other branches of engineering directly or indirectly. The Mechanical engineers can find their place in Automobile engineering sector, Steel Plants, Power plants, Software industries, Manufacturing industries, Design industries, Military, Naval and Air force, Defense research organizations, Material research organizations etc.

About the Workshop

The course builds from the big ideas in finite element analysis and computational fluid dynamics to ANSYS case studies that progress from real world applications and examples. ANSYS is the flagship engineering software solution that uses finite element analysis (FEA), which is a numerical and computational method used to solve the real engineering problems related to physics, structural analysis, heat transfer, fluid flow, mass transport, and electromagnetic potential field. To solve the problem, it subdivides a large problem into smaller, simpler parts that are called finite elements and solve the problem by minimizing an associated error function.



**Two week
Certification Course
on**

ANSYS

Organized by

**Department of Mechanical
Engineering**

Vysapuri, Bandlaguda Post, Keshavnagar
Hyderabad 500 005, Telangana INDIA
Tel: 040-64596979, 20020773, Fax: 040-24451001
E-mail: principal.mahaveer@gmail.com
Website: www.mist.ac.in

MAHAVEER



Approved by AICTE, Affiliated to JNTU(Hyd)

Date: 29-04-2019

To
The Principal
MIST,
Hyderabad.

Sub: Proposal for Add-on Course-Reg.

Respected sir,

We are going to conduct 10 days Technical Training for IV B. Tech students on "Introduction to ANSYS". We require your approval to go ahead for proceeding and hope to get an opportunity to serve you the best.

With thanks and regards

Final
PRINCIPAL
MAHAVEER
INSTITUTE OF SCIENCE & TECHNOLOGY
Bandlaguda, Hyderabad

Dr.S.Murali

HOD

Department of Mechanical Engineering



Date: 30.04.2019

CIRCULAR

Technical Training for IV B. Tech students are starting from 1st MAY, 2019 onwards. All HODs and Placements coordinators have to manage the trainings and ensure 95% attendance all through the sessions.

All Mentors need to send the compiled feedback report to Dr.S.Murali, HOD at e3hod.mech@gmail.com daily.

Agenda: 1. Introduction to ANSYS.

Design and Development of curriculum for Add on course:

Name of the Faculty : B.Venkateswar Reddy

Principal
MAHAVEER
INSTITUTE OF SCIENCE & TECHNOLOGY
Bandlaguda, Hyd-501 025

Dr.S.Murali

HOD

Department of Mechanical Engineering



ANSYS SYLLABUS

S.NO	TOPIC COVERED	DURATION (Hours)
1	INTRODUCTION TO FEA AND	3
2	BASIC SOLID MODELING	3
3	ADVANCED SOLID MODELING	3
4	FINITE ELEMENT MODELING (FEM) – I	3
5	FINITE ELEMENT MODELING (FEM) – II	3
6	SOLUTION AND POSTPROCESSOR	3
7	STATIC STRUCTURAL ANALYSIS	3
8	ADVANCED STRUCTURAL ANALYSIS (DYNAMIC AND NONLINEAR)	3
9	ADVANCED STRUCTURAL ANALYSIS	2
10	THERMAL ANALYSIS	2
11	GENERATING THE REPORT OF ANALYSIS	2



Department of Mechanical Engineering ANSYS Technical Training student attendance list 2019-2020

S.NO.	ROLL NO.	NAME OF THE STUDENT	YEAR
1	16E31A0301	B PRAVEEN KUMAR	IV
2	16E31A0305	G RAMAKRISHNA	IV
3	16E31A0306	G VENU GOPAL	IV
4	16E31A0307	GADDI SUDHAMSHU	IV
5	16E31A0308	GAJELLI VAMSHI KRISHNA	IV
6	16E31A0313	KOVA SAIKUMAR	IV
7	16E31A0314	LUNAVATH GANESH	IV
8	16E31A0318	MOHAMMED MUBEEN QURESHI	IV
9	16E31A0319	MOHD ABDUL SAMEER	IV
10	16E31A0320	MOHD ABDUL AHTESHAM UL HASNAIN	IV
11	16E31A0323	N SRIKANTH REDDY	IV
12	16E31A0324	NALLA TEJASWI	IV
13	16E31A0325	PANUGANTI SAI KIRAN GOUD	IV
14	16E31A0326	PATLOLLA PRASHANTH REDDY	IV
15	16E31A0327	PONNURU UPENDRA	IV
16	16E31A0328	PULJALA ANIL	IV
17	16E31A0329	PUNEET RAJ CHAVAN	IV
18	16E31A0330	PUTTAPAD YADIAH	IV
19	16E31A0331	R VAYU PUTHRA	IV
20	16E31A0332	RAMAKRISHNA LAKMALA	IV
21	16E31A0333	RAVULA HEMANTH KUMAR	IV
22	16E31A0334	SHAIK MUJAFER	IV

Vysakh, Bandisuda Post Keshavn,
Hyderabad 500 005, Telangana INDIA
Tel: 040-6459878/20020773, Fax: 040-24455003
E-mail: principal@mahaveer.com
Website: www.mahaveer.com

MAHAVEER



Approved by AICTE. Licensed to JNTUHYD

23	16E31A0336	SYED ZAINUDDIN ABID	IV
24	16E31A0337	TEJAVATH SRIKANTH	IV
25	16E31A0338	HONGAR NARAYANA	IV
26	16E31A0339	THOTA PAVAN KUMAR	IV
27	16E31A0340	YELTI SREYA	IV
28	16E31A0342	ABU SUFYAN MALIK	IV
29	16E31A0343	AKASH SABHNANI	IV
30	16E31A0344	AMERINANI ANIL KUMAR	IV
31	16E31A0345	ARAKALA SHIVA	IV
32	16E31A0346	BAGI VIJENDER REDDY	IV
33	16E31A0350	DEVI SHRI PRASAD PATANGI	IV
34	16E31A0351	EDAM SAIRAM	IV
35	16E31A0352	ERLA MAHENDRA KUMAR	IV
36	16E31A0353	ISHRATHI UNNISA BEGUM	IV
37	16E31A0354	KATPALLY SRENU REDDY	IV
38	16E31A0356	KOLLA RAJASHEKAR REDDY	IV
39	16E31A0358	KOMMIDI SHRAVAN REDDY	IV
40	16E31A0360	KOTHALAPURAM ANUSHA	IV
41	16E31A0361	KUDUTHALA AKHIL	IV
42	16E31A0362	MADHAGONE AKHIL TEJA	IV
43	16E31A0364	MOHAMMED LUQMAN ZAKI	IV
44	16E31A0365	MOHAMMED RIZWANUDDIN	IV
45	16E31A0368	PATHAKOTI JAGADISH	IV
46	16E31A0369	PULUGARI JAGADEESHWAR REDDY	IV
47	16E31A0370	PYATA PRASHANTH KUMAR	IV
48	16E31A0371	SHAIK SAMEER	IV

Mahaveer
MAHAVEER
Principal Mahaveer Education Trust
Hyderabad-500005

Vysrputi, Banilbaguda Post Keshavnagar,
Hyderabad 500 025, Telangana INDIA.
Tel: 040-64594979, 26020773, Fax: 040-24455093
E-mail: principal.mahaveer@gmail.com
Website: www.most-ar.in

MAHAVEER



Approved by AICTE, Affiliated to JNTUHYD

49	16E31A0374	SYED OMAIR AHMED	IV
50	16E31A0376	TUMMALA PALLY VINAY REDDY	IV
51	16E31A0377	V SHIVA KUMAR REDDY	IV
52	16E31A0378	VALGOTE NIKHIL KUMAR	IV
53	16E31A0379	YATA VISHNUVARDHAN REDDY	IV
54	15E31A0324	K SAI TEJA	IV
55	15E31A0323	K RAJESH	IV
56	15E31A0326	MD ABUBAKAR SIDDIQ	IV
57	17E35A0301	ALAKANTI SWARAJYAM	IV
58	17E35A0302	B MAHESH	IV
59	17E35A0303	BHOOMENI VENKATA SAI	IV
60	17E35A0304	BODIGAM SRINATH	IV
61	17E35A0305	GOMASA HARSHAVARDHAN	IV
62	17E35A0306	JAMPALA SAIKUMAR	IV
63	17E35A0307	KAIRAMKONDA SURESH	IV
64	17E35A0308	KARISHA SURESH	IV
65	17E35A0309	KONKATA KARTHIK	IV
66	17E35A0310	KUMMARA PAVANKUMAR	IV
67	17E35A0311	MAHESH	IV
68	17E35A0312	MD ASIF	IV
69	17E35A0313	MOGUNURI NARENDRA	IV
70	17E35A0314	MOHAMMED ABDUL RAQEEB	IV
71	17E35A0316	PAISHETTY NAGA VAMSHI	IV
72	17E35A0317	PANTHULU TARUN KUMAR	IV
73	17E35A0318	PORISHETTI BHANUCHANDER	IV
74	17E35A0319	SAMSARBANDA RAGHAVENDRA REDDY	IV

PRINCIPAL
MAHAVEER
INSTITUTE OF EDUCATION & RESEARCH
Banilbaguda, Hyderabad-500025

Vysapuri, Bandlaguda Post Keshavnagar,
Hyderabad-500 005, Telangana INDIA
Tel: 040-64556379, 20026773, Fax: 040-24455003
E-mail: principal.mahaveer@gmail.com
Website: www.mist.ac.in

MAHAVEER



Approved by AICTE. Affiliated to JNTU-Hyd

75	17E35A0320	SHAIK MINHAJUDDIN	IV
76	17E35A0321	SYED SOHAIL AHMED	IV
77	17E35A0322	VADLA SRIKANTH	IV
78	15E31A0335	MOHD ABDUL HASEEB	IV

Handwritten signature
MAHAVEER
INSTITUTE OF TECHNOLOGY
BANDLAGUDA



Technical Training Exam on ANSYS Software (A.Y-2019-2020)

2x10=20 Marks

Answer All the Questions

1.

Given the 2D truss structure represented in Figure 1.1, where:

- $h = 5 \text{ m}$
- $L = 5 \text{ m}$
- $F = 1000 \text{ N}$
- $E = 1.0 \times 10^8 \text{ N/m}^2$ (Young's modulus)
- $A = 0.1 \text{ m}^2$ (Cross-section area of each beam element)

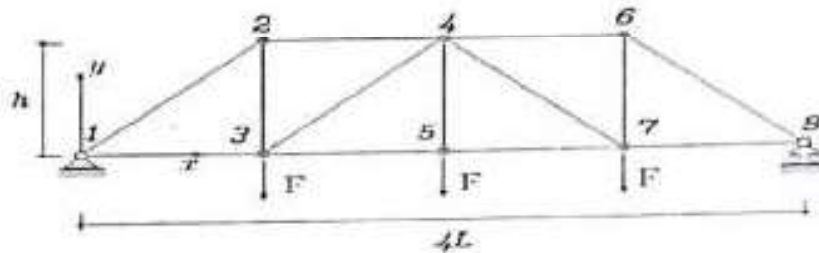

Figure 1.1: Example truss structure, constraints and loads.

2.

7.13

Determine the stresses in the plate with the hole subjected to the tensile stress shown in Figure P7-13. Graph the stress variation σ_x versus the distance y from the hole. Let $E = 200 \text{ GPa}$, $\nu = 0.25$, and $r = 25 \text{ mm}$. (Use various mesh densities, depending on your computer program in your finite element model.) Use symmetry as appropriate.



Figure P7-13



Department of Mechanical Engineering					
ANSYS Technical Training student attendance list 2019-20					
SLNO	Roll No	Name of the student	YEAR	MARKS	PASS/FAIL
1	16E31A0301	B PRAVEEN KUMAR	IV	14	PASS
2	16E31A0305	G RAMAKRISHNA	IV	15	PASS
3	16E31A0306	G VENU GOPAL	IV	17	PASS
4	16E31A0307	GADDI SUDHANSHU	IV	15	PASS
5	16E31A0308	GAJELLI VAMSHI KRISHNA	IV	16	PASS
6	16E31A0313	KOVA SAIKUMAR	IV	16	PASS
7	16E31A0314	LUNAVATH GANESH	IV	15	PASS
8	16E31A0318	MOHAMMED MUBEEN QURESHI	IV	14	PASS
9	16E31A0319	MOHD ABDUL SAMEER	IV	15	PASS
10	16E31A0320	MOHD ABDUL AHTESHAM UL HASNAIN	IV	17	PASS
11	16E31A0323	N SRIKANTH REDDY	IV	15	PASS
12	16E31A0324	NALLA TEJASWI	IV	16	PASS
13	16E31A0325	PANUGANTI SAI KIRAN GOUD	IV	15	PASS
14	16E31A0326	PATLOLLA PRASHANTH REDDY	IV	15	PASS
15	16E31A0327	PONNURU UPENDRA	IV	16	PASS
16	16E31A0328	PULJALA ANIL	IV	14	PASS
17	16E31A0329	PUNEET RAJ CHAVAN	IV	15	PASS
18	16E31A0330	PUTTAPAD YADAAH	IV	17	PASS
19	16E31A0331	R VAYU PUTHRA	IV	15	PASS
20	16E31A0332	RAMAKRISHNA LAKMALA	IV	16	PASS
21	16E31A0333	RAVULA HEMANTH KUMAR	IV	16	PASS
22	16E31A0334	SHAIK MUJAFER	IV	15	PASS
23	16E31A0336	SYED ZAINUDDIN ABED	IV	16	PASS

PRINCIPAL
MAHAVEER
COLLEGE OF ENGINEERING
AND TECHNOLOGY
VENUGURI

Vysarim, Bantaguda Post, Keshavnagar,
Hyderabad 500 001, Telangana INDIA
Tel: 040 64096379 20820773, Fax: 040 24493003
E-mail: principal.mahaveer@gmail.com
Website: www.mahaveer.in

MAHAVEER



Approved by AICTE, Affiliated to JNTUHYD

24	16E31A0337	TEJAVATHI SRIKANTHI	IV	14	PASS
25	16E31A0338	THONGAR NARAYANA	IV	15	PASS
26	16E31A0339	THOTA PAVAN KUMAR	IV	15	PASS
27	16E31A0340	YELTI SREYA	IV	16	PASS
28	16E31A0342	ABU SUFYAN MALIK	IV	14	PASS
29	16E31A0343	AKASHI SABINANI	IV	16	PASS
30	16E31A0344	AMERINANI ANIL KUMAR	IV	15	PASS
31	16E31A0345	ARAKALA SHIVA	IV	14	PASS
32	16E31A0346	BAGI VIJENDER REDDY	IV	18	PASS
33	16E31A0350	DEVI SHRI PRASAD PATANGI	IV	15	PASS
34	16E31A0351	EDAM SAIRAM	IV	16	PASS
35	16E31A0352	ERLA MAHENDRA KUMAR	IV	16	PASS
36	16E31A0353	ISHRATH UNNISA BEGUM	IV	15	PASS
37	16E31A0354	KATPALLY SRENU REDDY	IV	16	PASS
38	16E31A0356	KOLLA RAJASHEKAR REDDY	IV	15	PASS
39	16E31A0358	KOMMIDI SHRAVAN REDDY	IV	14	PASS
40	16E31A0360	KOTHALAPURAM ANUSHA	IV	18	PASS
41	16E31A0361	KUDUTHALA AKHIL	IV	15	PASS
42	16E31A0362	MADEHAGUNI AKHIL TEJA	IV	16	PASS
43	16E31A0364	MOHAMMED LUQMAN ZAKI	IV	16	PASS
44	16E31A0365	MOHAMMED RIZWANUDDIN	IV	15	PASS
45	16E31A0368	PATHAKOTI JAGADISH	IV	16	PASS
46	16E31A0369	PULUGARI JAGADEESHWAR REDDY	IV	14	PASS
47	16E31A0370	PYATA PRASHANTH KUMAR	IV	18	PASS
48	16E31A0371	SHAIK SAMEER	IV	15	PASS

Handwritten signature
Principal
MAHAVEER
Vysarim, Bantaguda Post, Keshavnagar,
Hyderabad 500 001, Telangana INDIA
Tel: 040 64096379 20820773, Fax: 040 24493003
E-mail: principal.mahaveer@gmail.com
Website: www.mahaveer.in

Vysyaleti, Bandlaguda Post Keshavnagar
Hyderabad 500 005, Telangana INDIA
Tel: 940-64208379-20020773, Fax: 040-28455003
E-mail: principal@mahaveer.com
Website: www.mahaveer.com

MAHAVEER



Approved by AICTE, Attached to JNTUHYD

49	16E31A0374	SYED OMAIR AHMED	IV	16	PASS
50	16E31A0376	TUMMALA PALLY VINAY REDDY	IV	15	PASS
51	16E31A0377	V SHIVA KUMAR REDDY	IV	16	PASS
52	16E31A0378	VALGOTE NIKHIL KUMAR	IV	15	PASS
53	16E31A0379	YATA VISHNU VARDHAN REDDY	IV	16	PASS
54	15E31A0324	K SAI TEJA	IV	15	PASS
55	15E31A0323	K RAJESH	IV	14	PASS
56	15E31A0326	MD ABUBAKAR SIDDIQ	IV	18	PASS
57	17E35A0301	ALAKANTI SWARAJYAM	IV	15	PASS
58	17E35A0302	B MAHESH	IV	16	PASS
59	17E35A0303	BHOOMENI VENKATA SAI	IV	15	PASS
60	17E35A0304	BODIGAM SRINATH	IV	16	PASS
61	17E35A0305	GOMASA HARSHAVARDHAN	IV	15	PASS
62	17E35A0306	JAMPALA SAIKUMAR	IV	16	PASS
63	17E35A0307	KAIRAMKONDA SURESH	IV	15	PASS
64	17E35A0308	KARISHA SURESH	IV	14	PASS
65	17E35A0309	KONKATA KARTHIK	IV	18	PASS
66	17E35A0310	KUMMARA PAVANKUMAR	IV	15	PASS
67	17E35A0311	MAHESH	IV	16	PASS
68	17E35A0312	MD ASH	IV	16	PASS
69	17E35A0313	MOGLUNURI NARENDRA	IV	15	PASS
70	17E35A0314	MOHAMMED ABDUL RAQEEB	IV	16	PASS
71	17E35A0316	PAISHETTY NAGA VAMSHI	IV	15	PASS
72	17E35A0317	PANTHULU TARUN KUMAR	IV	14	PASS

Principal
MAHAVEER
INSTITUTE OF TECHNOLOGY
Bandlaguda - Hyderabad

Vysapuri, Bandhupada Post, Keshavnagar,
Hyderabad 501 625, Telangana INDIA.
Tel: 040 64536979/20029773, Fax: 040 24453693
E-mail: principal@mahaveer@gmail.com
Website: www.mahaveer.in

MAHAVEER



Approved By AICTE, Affiliated to JNTUHYD

73	17E35A0318	PORISHETTI BILANUCHANDER	IV	18	PASS
74	17E35A0319	SAMSARIBANDA RAGHAVENDRA REDDY	IV	15	PASS
75	17E35A0320	SHAIK MINHAJ UDDIN	IV	16	PASS
76	17E35A0321	SYED SOHAIL AHMED	IV	16	PASS
77	17E35A0322	VADLA SRIKANTH	IV	15	PASS
78	15E31A0335	MOHD ABDUL HASEEB	IV	16	PASS

Principal
MAHAVEER
Keshavnagar
Hyderabad



ANSYS COURSE Summary

Department of Mechanical Engineering

1. The Geometry preparation training course is for users who want to create and modify geometry in preparation for CFD or FEA analysis. The training will be focused in either ANSYS Design Modeler or ANSYS Space Claim.
2. The ANSYS Meshing training course will give you the tools for generating good quality meshes for Fluent and CFX. The trainee will choose which tool should be used: ANSYS Meshing, Fluent Meshing or ICEM CFD.
3. This course will show how to set up a range of simulation types in the ANSYS Fluent or ANSYS CFX solver, as well as how to post process the results by using our CFD Post Tool.
4. This course will show how to set up a range of simulation types in ANSYS Mechanical, as well as how to post process and evaluate your results.
5. To acquire advance knowledge to perform explicit simulations with ANSYS Explicit STR, ANSYS AUTODYN or ANSYS LS-DYNA.
6. This is an introductory to intermediate level training for using ANSYS HFSS for all applications, like RF/microwave, antennas or planar problems. Participants will get understanding of HFSS modeling, solution process and post-processing features, which can be used for other advanced applications. The course will also cover advanced topics like dynamic link between EM and circuit, impedance matching, overview of HFSS 3D layout interface and speeding-up HFSS simulation using HPC.
7. Provide the needed tools for the complete simulation of a pressure Vessel from scratch. Several types of analysis and boundary conditions will be discussed, by using pressure vessel examples.
8. To acquire advance knowledge for performing mechanical simulation in Fixed Offshore Structures.

Copy to :

1. Department of Notice Board
2. Principal for Information
3. Committee Members (Academic)

Handwritten signature

Principal
Department of Charge & Technology
Kondraguda, Hyd-500 005

Nysapuri, Bandlaguda Post, Keshavnagar
Hyderabad 500 005, Telangana 500005
Tel: 040-84156078, 20020779. Fax: 040-24416003
E-mail: principal.mahaveer@gmail.com
Website: www.mist.ac.in

MAHAVEER



Approved by AICTE, Affiliated to JNTUHYDR

CERTIFICATE OF COURSE COMPLETION

This certificate is presented to Gr. Venu Gopal of
MIST, who has successfully completed technical training course on
"ANSYS" held from 01-05-2019 to 13-05-2019 and found the
student performance to be excellent.

Kanishk
PRINCIPAL
MAHAVEER
NYSAPURI, BANDLAGUDA POST, KESHAVNAGAR,
HYDERABAD, PIN-500 005.



ESTD : 2001

Dr. Kanishk
HOD

Department of Mechanical Engineering

DEPARTMENT OF MECHANICAL ENGINEERING

List of students enrolled in ANSYS (2019-2020)

S.No	Roll No	Name of the student	Date	16/08/19	21/8	28/8	04/9	11/9	18/9	25/9	02/10	09/10	16/10	23/10
1	16E31A0301	B PRAVEEN KUMAR		P	P	P	P	P	P	P	P	P	P	P
2	16E31A0305	G RAMAKRISHNA		P	P	P	P	P	P	P	P	P	P	P
3	16E31A0306	G VENU GOPAL		P	P	P	P	P	P	P	P	P	P	P
4	16E31A0307	GADDI SUDHAMINI		P	P	P	P	P	P	P	P	P	P	P
5	16E31A0308	GAJELLI YAMSHI KRISHNA		P	P	P	P	P	P	P	P	P	P	P
6	16E31A0313	KOVA SAIKUMAR		P	P	P	P	P	P	P	P	P	P	P
7	16E31A0314	LUNAVATHI GANANI		P	P	P	P	P	P	P	P	P	P	P
8	16E31A0318	MOHAMMED MUBEN QURESHI		P	P	P	P	P	P	P	P	P	P	P
9	16E31A0319	MOHD ABDUL SAMEER		P	P	P	P	P	P	P	P	P	P	P
10	16E31A0320	MOHD ABDUL MUHAMMAD UL HASNAIN		P	P	P	P	P	P	P	P	P	P	P
11	16E31A0323	N SRIKANTH REDDY		P	P	P	P	P	P	P	P	P	P	P

Handwritten signature
Date: 16/10/2020

Vysapuri, Bandlaguda Post:Keshavgiri,

MAHAVEER

INSTITUTE OF SCIENCE & TECHNOLOGY



Hyderabad-500 005, TELANGANA INDIA

Tel: 040-64596979,8978380692.Fax: 040-24455003

Approved by AICTE, Affiliated to JNTUH,Hyd.

E-mail: e3hod.it@gmail.com, Website: www.mist.ac.in.

DEPARTMENT OF ELECTRONICS AND COMMUNICATION ENGINEERING

MIST/ECE dept./2/2019-20

03-07-2019

To
The Principal
Mahaveer Institute Science & Technology
Hyderabad.

Sir,
Sub: Request for approval to include ADD -ON subject in regular curriculum of B.Tech, ECE
Resource Person: Dr V. N Mani, Scientist F
C-MET, Govt. of India
Hyderabad -500051

In order to increase employability and entrepreneurship for students pursuing B.TECH , department ECE is planning to organise **ROLE OF ADVANCED ELECTRONIC MATERIALS & DEVICES IN SPACE & DEFENCE APPLICATIONS** as add-on course in regular curriculum for **AY 2019-20** for B.TECH 4th year semester- I, apart from regular syllabus as per the JNTUH.

Thanking You

HOD, ECE Dept.

PRINCIPAL
MAHAVEER
INSTITUTE OF SCIENCE & TECHNOLOGY
Bandlaguda, Hyd-500 005.

DEPARTMENT OF ELECTRONICS & COMMUNICATION ENGINEERING
Vysapuri, Bandlaguda Post: Keshavgi,
Hyderabad-500 005, AP INDIA
Tel: 040-20020772, 20020773, Fax: 040-24455003
E-mail: e3hod.ec@mist.ac.in
Website: www.mist.ac.in

MAHAVEER
INSTITUTE OF SCIENCE & TECHNOLOGY
Approved by AICTE. Affiliated to JNTUH, Hyd.



Date: 15/07/2019

To
Dr. V.N. Mani, Scientist-I
Center for Materials for Electronics & Technology (C-MET), Govt. of India,
Hyderabad-500051

Mobile no: 7382489862

Dear Sir,

As you may be aware, we, MIST, are part of the reputed **MAHAVEER** group of educational institutions and have been in the service of imparting quality education to the society since 2001 i.e. last 18 years.

As part of our overall efforts to improve the outlook of students, we regularly invite scientists, engineers, technocrats, academicians and entrepreneurs of repute to visit our institute and share the latest technical developments and valuable learning's from their professional life with our students. As a part of this 'Invited Technical Lecture' series, many individuals of repute have already delivered lectures at our institute for the benefit of our students and faculty.

As you is a well-known expert with deep domain knowledge in the area of **DESIGN OF ELECTRONICS DEVICES**. It would be a great pleasure to us in inviting you for delivering your expert guest lectures to our students for the subject **"ROLE OF ADVANCED ELECTRONIC MATERIALS AND DEVICES IN SPACE AND DEFENCE APPLICATIONS"** approximately two hours duration in a day in every week during 1st Semester.

We are thankful for accepting our request.

The following is the schedule of expert lectures on the subjects:-
Every Saturday 3rd & 4th periods, except 2nd Saturday of month.

Thanking you,

*Your kind invitation
Accepted & I shall
deliver the talk
17/07/2019*

Yours sincerely

HOD, ECE Department,
MIST

Dr. V. N. MANI
Scientist-I
Center for Materials for Electronics Technology (C-MET)
Ministry of Electronics & Information Technology (MITE)
20, 21st floor
IDA Phase-I, Cheruvu, F-2, P. O.
Hyderabad-500 005, Telangana State, India

PRINCIPAL
MAHAVEER

PRINCIPAL
MAHAVEER
INSTITUTE OF SCIENCE & TECHNOLOGY
Bandlaguda, Hyd-500 005

Vysapuri, Bandlaguda Post:Keshavgi.

MAHAVEER

INSTITUTE OF SCIENCE & TECHNOLOGY

Hyderabad-500 005, TELANGANA INDIA

Tel: 040-64596979,8978380692,Fax: 040-24455003

Approved by AJGTE, Affiliated to JNTUH,Hyd.

E-mail: e3hod.it@gmail.com, Website: www.mahaveer.ac.in

DEPARTMENT OF ELECTRONICS AND COMMUNICATION ENGINEERING



Date: 01-08-2019

CIRCULAR

Technical Trainings on **ROLE OF ADVANCED ELECTRONIC MATERIALS & DEVICES IN SPACE & DEFENCE APPLICATIONS** is starting from **03-08-2019** onwards. All the students IV year B. Tech should attend.

Design and development of curriculum for add-on courses:

Faculty Names: 1.Dr. Jaspal Kumar

2.Mr.P Sridhar

3.Mrs. S Soujanya

HOD, ECE

Cc: Principal for information
: Coordinator to inform the students
: Notice board & department File.



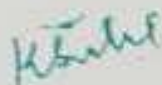

PRINCIPAL
MAHAVEER
INSTITUTE OF SCIENCE & TECHNOLOGY
BANDLAGUDA POST - 500 005

Vysapuri, Bandlaguda Post:Keshavgiri,

MAHAVEER

INSTITUTE OF SCIENCE & TECHNOLOGY



Hyderabad-500 005, TELANGANA INDIA

Tel: 040-64590970,8978380092 Fax: 040-24455003

Approved by AICTE, Affiliated to JNTUH,Hyd

E-mail: a3hod.ii@gmail.com, Website: www.mahaveer.ac.in

DEPARTMENT OF ELECTRONICS AND COMMUNICATION ENGINEERING

ADVANCED EDC-SYLLABUS

BJT small signal model – Analysis of CE, CB, CC amplifiers- Gain and frequency response – MOSFET small signal model- Analysis of CS and Source follower – Gain and frequency response- High frequency analysis.

BIMOS cascade amplifier, Differential amplifier – Common mode and Difference mode analysis – FET input stages – Single tuned amplifiers – Gain and frequency response – Neutralization methods, power amplifiers –Types (Qualitative analysis).

Advantages of negative feedback – voltage / current, series, Shunt feedback – positive feedback – Condition for oscillations, phase shift – Wien bridge, Hartley, Colpits and Crystal oscillators.

Duration : 20 to 25 hrs /semester

K. S. S. S.

PRINCIPAL
M. MAHAVEER
INSTITUTE OF SCIENCE & TECHNOLOGY
Bandlaguda, Hyd-500 005.

Vysapuri, Bandlaguda Post:Keshavgi,

MAHAVEER

INSTITUTE OF SCIENCE & TECHNOLOGY



Hyderabad-500 005, TELANGANA INDIA

Tel: 040-64596979,8978380692,Fax: 040-24455003

Approved by AICTE, Affiliated to JNTUH,Hyd.

E-mail: e3hod.it@gmail.com, Website: www.mist.ac.in

DEPARTMENT OF ELECTRONICS AND COMMUNICATION ENGINEERING

STUDENTS REGISTERED (AY 2019-20)

S.NO	H.T. NO.	NAME OF STUDENT
1	16E31A0401	ADARSHINA AKSHAYA
2	16E31A0402	AENUGULA SWATHI
3	16E31A0403	ANAGOUNI SHIVANI GOUD
4	16E31A0405	ASHAJA GANESH
5	16E31A0406	ASVATHI BHARGAVI
6	16E31A0407	B NAVYA SRI
7	16E31A0408	RADAM SAI SHANKER
8	16E31A0410	BYREDDY SRIDEVI
9	16E31A0413	DESHAM PREETHIKA
10	16E31A0415	DHARAVATH THARUN
11	16E31A0416	ENGAMURI PAVAN SAI PREETAM
12	16E31A0418	G HARISH
13	16E31A0420	HASBI SHRUTHI
14	16E31A0421	JAGIDI VAMSHIKRISHNA
15	16E31A0422	KAKUTTAM PAVANI
16	16E31A0423	KALWA HARIGA
17	16E31A0426	KONAPARTHY ANTA CHARY
18	16E31A0427	KOTTALA VIKRAM
19	16E31A0428	KOYADA SWARNALATHA
20	16E31A0429	KULKARNI MANOJ
21	16E31A0430	LAGISHETTY ADITHYA
22	16E31A0433	MOHAMMAD AMEER KHAN
23	16E31A0435	FAKEER GANESH
24	16E31A0436	PANYALA NAVYASREE
25	16E31A0437	PARIDULA SHIVA TEJA
26	16E31A0438	PETA SAI TEJA
27	16E31A0439	POKURI SHEKAR
28	16E31A0440	BRAVALIKA GADDAM
29	16E31A0442	RAPELLI HARIKA
30	16E31A0443	SHAIK RASHEEDA BEGUM

K. Srinivas

PRINCIPAL
MAHAVEER
INSTITUTE OF SCIENCE & TECHNOLOGY
Bandlaguda, Hyd-500 005.

Vysapuri, Bandlaguda Post:Keshavgiri,

MAHAVEER

INSTITUTE OF SCIENCE & TECHNOLOGY

Hyderabad-500 005, TELANGANA INDIA

Tel: 040-64596979,8978380692,Fax: 040-24455003

Approved by AICTE. Affiliated to JNTUH Hyd.

E-mail: e3hod.it@gmail.com, Website: www.mst.ac.in

DEPARTMENT OF ELECTRONICS AND COMMUNICATION ENGINEERING



31	18E31A0456	ABHILASH REDDY KODIGANTI
32	18E31A0457	AERUKALA SAI CHITRA
33	18E31A0459	ANANTHODJU SHIVANI
34	18E31A0460	ANKAM SRIVARSHA
35	18E31A0461	ANNABOINA SHALINI
36	18E31A0462	ANNAM SRIVAN
37	18E31A0463	ANUGONDA KIRAN KUMAR REDDY
38	18E31A0464	ANUMOLU NARENDRA SAI
39	18E31A0465	B PRADEEP
40	18E31A0466	BATTA SREE AMRUTH VAMSHI
41	18E31A0467	BLIJALA SHRAVANI
42	18E31A0468	BODDUPALLI VAMSHIKRISHNA
43	18E31A0469	CH SUSHMITHA
43	18E31A0470	CHALLA VARUN REDDY
44	18E31A0471	CHEKKALA GANESH
45	18E31A0472	CHILUKA HARISH
46	18E31A0474	CHITTEPU PREMALATHA
47	18E31A0475	CHOLLETI KAVYA
48	18E31A0476	ELAGANDHALA VAMSHI PRANAY
48	18E31A0477	ELLENDULA VARSHITH
50	18E31A0479	GANGIREDDY MAHENDER

Khanh

PRINCIPAL
MAHAVEER
INSTITUTE OF SCIENCE & TECHNOLOGY
Bandlaguda, Hyd-500 005

Vysapuri, Bandlaguda Post: Keshavgi,

MAHAVEER

INSTITUTE OF SCIENCE & TECHNOLOGY



Hyderabad-500 005, TELANGANA INDIA

Tel: 040-64596979, 8978380692, Fax: 040-24455003

Approved by AICTE, Affiliated to JNTUH, Hyd.

E-mail: e3hod.it@gmail.com, Website: www.mist.ac.in

DEPARTMENT OF ELECTRONICS AND COMMUNICATION ENGINEERING

QUESTION PAPER

ROLE OF ADVANCED ELECTRONIC MATERIALS & DEVICES IN SPACE & DEFENCE APPLICATIONS:

Duration: 120 Minutes

5 X 6 = 30 Marks

Answer the following all questions. Each question carries 6 marks.

1. Explain the operation of BJT as an Amplifier in CE Configuration.
2. Input and Output Characteristics In CE And CB Configurations
3. Self Bias Circuit Operation why it is Better Compared To All explain it.
4. Write about Compensation techniques
5. Compare the CB, CE, CC Configurations

K. K. K.

PRINCIPAL
MAHAVEER
INSTITUTE OF SCIENCE & TECHNOLOGY
Bandlaguda, Hyd-500 005.

Vysapuri, Bandlaguda Post:Keshavpuri,

MAHAVEER

INSTITUTE OF SCIENCE & TECHNOLOGY



Hyderabad-500 005, TELANGANA INDIA

Tel: 040-64596970,8978380692 Fax: 040-24455003

Approved by AICTE, Affiliated to JNTUH,Hyd.

E-mail: e3hod.it@gmail.com, Website: www.mist.ac.in

DEPARTMENT OF ELECTRONICS AND COMMUNICATION ENGINEERING

STUDENTS ATTENDANCE & RESULT (AY 2019-20)

S.NO.	RLT. NO.	NAME OF STUDENT	ATTENDANCE 20HRS	MARKS OBTAINED(30)
1	16E31A0401	ADABOINA AKSHAYA	17	27
2	16E31A0402	AENUGULA SWATHI	18	24
3	16E31A0403	ANAGOUNI SHIVANI GOUD	18	14
4	16E31A0404	ASHALA GANESH	20	25
5	16E31A0406	AVVARI BHARGAVI	17	21
6	16E31A0407	B NAVYA SRI	20	15
7	16E31A0408	BADAM SAI SHANKER	17	14
8	16E31A0410	BYREDDY SRIDEVI	20	22
9	16E31A0413	DENHAM PREETHIKA	20	28
10	16E31A0415	DHARAVATHI THARUN	20	ABSENT
11	16E31A0416	ENJAMURI PAVAN SAI PREETAM	17	26
12	16E31A0418	G HARSH	18	12
13	16E31A0420	HASBI SERLUTHI	18	22
14	16E31A0421	JACIDI VAMSIKRISHNA	20	23
15	16E31A0422	KAKUSTAM PAVANI	17	22
16	16E31A0423	KALWA HARIKA	20	25
17	16E31A0426	KONAPARTHY ANJA CHARY	18	26
18	16E31A0427	KOTTALA VIKRAM	20	23
19	16E31A0428	KOYADA SWARNALATHA	19	29
20	16E31A0429	KULKARNI MANOJ	17	23
21	16E31A0430	LAGSHEETTY ADITHYA	18	20
22	16E31A0433	MOHAMMAD AMEER KHAN	20	27
23	16E31A0433	FAKEER GANESH	20	24
24	16E31A0436	PANYALA NAVYASREE	20	21
25	16E31A0437	FARIDULA SHIVA TEJA	20	25
26	16E31A0438	PETA SAI TEJA	18	25
27	16E31A0439	POKURI SHEKAR	19	20
28	16E31A0440	PRAVATIKA GADDAM	20	21
29	16E31A0442	RAPELLI HARIKA	18	23
30	16E31A0443	SHAIK RASHEEDA BEGUM	20	22

Khandi
PRINCIPAL
MAHAVEER INSTITUTE OF SCIENCE & TECHNOLOGY
Bandlaguda, Hyd-500 005

Vysapuri, Bandlaguda Post:Keshavgiri,

MAHAVEER

INSTITUTE OF SCIENCE & TECHNOLOGY



Hyderabad-500 005, TELANGANA INDIA

Tel: 040-64596979,8978380692 Fax: 040-24455003

Approved by AICTE, Affiliated to JNTUH,Hyd

E-mail: e3hod.it@gmail.com, Website: www.mist.ac.in

DEPARTMENT OF ELECTRONICS AND COMMUNICATION ENGINEERING

31	16E31A0455	ABHILASH REDDY KODIGANTI	17	23
32	16E31A0457	AERUKALA SAI CHITRA	16	22
33	16E31A0459	ANANTHOJU SHIVANI	18	25
34	16E31A0460	ANKAM SRIVARSHA	20	28
35	16E31A0461	ANNABOINA SHALINI	17	23
36	16E31A0462	ANNAM BRAVAN	20	28
37	16E31A0463	ANJGONDA KIRAN KUMAR REDDY	16	23
38	16E31A0464	ANUMOLU NARENDRA SAI	20	20
39	16E31A0465	B PRADEEP	19	27
40	16E31A0466	BATTA SREE AMRUTH VAMSHI	17	24
41	16E31A0467	BIJJALA SHRAVANI	18	21
42	16E31A0468	BODDUPALLI VAMSHIKRISHNA	20	25
43	16E31A0469	CH SUSHMITHA	20	25
43	16E31A0470	CHALLA VARUN REDDY	20	20
44	16E31A0471	CHEKKALA GANESH	20	21
45	16E31A0472	CHILUKA HARISH	18	31
46	16E31A0474	CHITTEPU PREMALATHA	19	32
47	16E31A0475	CHOLLETI KAVYA	20	23
48	16E31A0476	ELAGANDHALA VAMSHI PRANAY	18	22
49	16E31A0477	ELLENDULA VARSHITH	20	24
50	16E31A0479	GANGIREDDY MAHENDER	18	28

Handwritten signature

PRINCIPAL
M. S. R.
MAHAVEER INSTITUTE OF SCIENCE & TECHNOLOGY
Bandlaguda, hyd-500 005

STUDENTS REGISTERED ATTENDANCE & RESIDENCY MAY 2019-20

Sl No	H T NO	NAME OF STUDENT	1	2	3	4	5	6	7	8	9	10	11	12	13	14	15	16	17	
1	16E31A0490	ALABHISHA ANGEYANA	1	2	3	4	5	6	7	8	9	10	11	12	13	14	15	16	17	
2	16E31A0492	AJESU GEELA SWATHI	A	1	2	3	4	5	6	7	8	9	10	11	12	13	14	15	16	17
3	16E31A0493	ANACKOTINI SHIVANI GOUD	1	2	3	4	5	6	7	8	9	10	11	12	13	14	15	16	17	18
4	16E31A0495	ASHALA GANESH	1	2	3	4	5	6	7	8	9	10	11	12	13	14	15	16	17	18
5	16E31A0496	AVVARI BHARGAVI	1	2	3	4	5	6	7	8	9	10	11	12	13	14	15	16	17	18
6	16E31A0497	B NAVYA SRI	1	2	3	4	5	6	7	8	9	10	11	12	13	14	15	16	17	18
7	16E31A0498	BADAM SAI SHANKER	1	2	3	4	5	6	7	8	9	10	11	12	13	14	15	16	17	18
8	16E31A0499	BYREDDY SRIDEVI	1	2	3	4	5	6	7	8	9	10	11	12	13	14	15	16	17	18
9	16E31A0493	DESHAM PREETHIKA	1	2	3	4	5	6	7	8	9	10	11	12	13	14	15	16	17	18
10	16E31A0495	DESHAM PREETHIKA	1	2	3	4	5	6	7	8	9	10	11	12	13	14	15	16	17	18
11	16E31A0496	DESHAM PREETHIKA	1	2	3	4	5	6	7	8	9	10	11	12	13	14	15	16	17	18
12	16E31A0498	G BHARSHI	1	2	3	4	5	6	7	8	9	10	11	12	13	14	15	16	17	18
13	16E31A0499	HASHI SIBULJE	1	2	3	4	5	6	7	8	9	10	11	12	13	14	15	16	17	18
14	16E31A0499	JAYITHI VAMSHIKRISHNA	1	2	3	4	5	6	7	8	9	10	11	12	13	14	15	16	17	18
15	16E31A0497	K. KALANJANI RAJANI	1	2	3	4	5	6	7	8	9	10	11	12	13	14	15	16	17	18
16	16E31A0498	K. KALANJANI RAJANI	1	2	3	4	5	6	7	8	9	10	11	12	13	14	15	16	17	18
17	16E31A0495	KONAPARTHY ANJALICARY	1	2	3	4	5	6	7	8	9	10	11	12	13	14	15	16	17	18
18	16E31A0497	KOTIALA VIKRAM	1	2	3	4	5	6	7	8	9	10	11	12	13	14	15	16	17	18
19	16E31A0498	KOVVURU BHARATHA	1	2	3	4	5	6	7	8	9	10	11	12	13	14	15	16	17	18
20	16E31A0499	KULKARNI BHANU	1	2	3	4	5	6	7	8	9	10	11	12	13	14	15	16	17	18
21	16E31A0499	LAGISHETTI ADITHYAN	1	2	3	4	5	6	7	8	9	10	11	12	13	14	15	16	17	18
22	16E31A0493	MOHAMMAD AMER KHAN	1	2	3	4	5	6	7	8	9	10	11	12	13	14	15	16	17	18
23	16E31A0495	MURUGANANTH	1	2	3	4	5	6	7	8	9	10	11	12	13	14	15	16	17	18
24	16E31A0499	PAVANA SAI SHANKER	1	2	3	4	5	6	7	8	9	10	11	12	13	14	15	16	17	18
25	16E31A0495	RAJITHA SHIVAJITHA	1	2	3	4	5	6	7	8	9	10	11	12	13	14	15	16	17	18
26	16E31A0498	PIETASAKTEJA	1	2	3	4	5	6	7	8	9	10	11	12	13	14	15	16	17	18
27	16E31A0499	POKURI SREKAR	1	2	3	4	5	6	7	8	9	10	11	12	13	14	15	16	17	18
28	16E31A0499	PRAVALLA GADDAM	1	2	3	4	5	6	7	8	9	10	11	12	13	14	15	16	17	18
29	16E31A0492	RAPATI HARIKA	1	2	3	4	5	6	7	8	9	10	11	12	13	14	15	16	17	18
30	16E31A0494	SHAIK RAJULEDA BEEJUM	1	2	3	4	5	6	7	8	9	10	11	12	13	14	15	16	17	18

Kanduri

PRINCIPAL
 M. JAYVEER
 INSTITUTE OF ENGINEERING & TECHNOLOGY
 Bandelapally, Hyd-500 002

31	16E31A0450	ABHILASH REDDY KODAMATI	A	1	2	3	4	5	6	7	8	9	10	11	12	13	14	15	16	17
32	16E31A0451	ABHILASH REDDY KODAMATI	A	1	2	3	4	5	6	7	8	9	10	11	12	13	14	15	16	17
33	16E31A0452	ANANTHOU SHIVANI	1	2	3	4	5	6	7	8	9	10	11	12	13	14	15	16	17	18
34	16E31A0453	ANKAMI SRINARSHA	1	2	3	4	5	6	7	8	9	10	11	12	13	14	15	16	17	18
35	16E31A0454	ANNARAJA SHALINI	1	2	3	4	5	6	7	8	9	10	11	12	13	14	15	16	17	18
36	16E31A0455	ANNAM SRIVAN	1	2	3	4	5	6	7	8	9	10	11	12	13	14	15	16	17	18
37	16E31A0456	ANUSONIA KUMAR KUMAR REDDY	A	1	2	3	4	5	6	7	8	9	10	11	12	13	14	15	16	17
38	16E31A0457	ANUMOLU NARENDRAN SAI	1	2	3	4	5	6	7	8	9	10	11	12	13	14	15	16	17	18
39	16E31A0458	B PRADEEP	A	1	2	3	4	5	6	7	8	9	10	11	12	13	14	15	16	17
40	16E31A0459	BATTA SREE ANRUTH VAMSHI	1	2	3	4	5	6	7	8	9	10	11	12	13	14	15	16	17	18
41	16E31A0460	BIJAJA SHRAVANI	1	2	3	4	5	6	7	8	9	10	11	12	13	14	15	16	17	18
42	16E31A0461	BODUPALLI VAMSHI SURESH	1	2	3	4	5	6	7	8	9	10	11	12	13	14	15	16	17	18
43	16E31A0462	CH SUSHMITHA	1	2	3	4	5	6	7	8	9	10	11	12	13	14	15	16	17	18
44	16E31A0463	CHALLAVARUN REDDY	1	2	3	4	5	6	7	8	9	10	11	12	13	14	15	16	17	18
45	16E31A0464	CHEKKA J ANEESH	1	2	3	4	5	6	7	8	9	10	11	12	13	14	15	16	17	18
46	16E31A0465	CHILUKUNTA HARISH	1	2	3	4	5	6	7	8	9	10	11	12	13	14	15	16	17	18
47	16E31A0466	CHITRAL PREMALAKSHA	A	1	2	3	4	5	6	7	8	9	10	11	12	13	14	15	16	17
48	16E31A0467	CHOLLETTI KAVYA	1	2	3	4	5	6	7	8	9	10	11	12	13	14	15	16	17	18
49	16E31A0468	ELAGANDHILA VAMSHI PRUDHAY	1	2	3	4	5	6	7	8	9	10	11	12	13	14	15	16	17	18
50	16E31A0469	ELUENDULA VARESHITH	1	2	3	4	5	6	7	8	9	10	11	12	13	14	15	16	17	18
51	16E31A0470	BANGIREDDY HANENDER	A	1	2	3	4	5	6	7	8	9	10	11	12	13	14	15	16	17

Handwritten signature
HOD, CEE

Handwritten signature
C. Srinivas

Handwritten signature
D. S.

Handwritten signature
Kandam

PRINCIPAL
MAHARAJA
INSTITUTE OF TECHNOLOGY
Bandipur, Mysore

Vysapuri, Bandlaguda Post:Keshavgiri,

MAHAVEER

INSTITUTE OF SCIENCE & TECHNOLOGY

Approved by AICTE. Affiliated to JNTUH,Hyd.



Hyderabad-500 005, TELANGANA INDIA

Tel: 040-64596979,8978380692 Fax: 040-24455003

E-mail: e3hod.it@gmail.com

Website: www.mist.ac.in

DEPARTMENT OF ELECTRONICS AND COMMUNICATION ENGINEERING

MIST/ECE dept./3/2019-20

09-12-2019

To:
The Principal
Mahaveer Institute Science & Technology
Hyderabad.

Sir,

Sub: Request for approval to include ADD -ON subject in regular curriculum of B.Tech, ECE

Resource Person: Dr. V. N Mani, Scientist F
C-MET, Govt. of India
Hyderabad -500051

In order to increase employability and entrepreneurship for students pursuing B.TECH, department ECE is planning to **Advanced VLSI TECHNOLOGY** as add-on course in regular curriculum of AY 2019-20 for B.TECH 4th year II Semester, apart from regular syllabus as per the JNTUH.

Thanking You

HOD, ECE Dept.



PRINCIPAL
MAHAVEER INSTITUTE OF SCIENCE & TECHNOLOGY
BANDLAGUDA, HYD-500005

DEPARTMENT OF ELECTRONICS & COMMUNICATION ENGINEERING

Vysapuri, Bandlaguda Post, Keshavgi, Hyderabad-500 005, AP INDIA
Tel: 040-20020772, 20020773, Fax: 040-24455003
E-mail: e3hod.eco@gmail.com
Website: www.mist.ac.in

MAHAVEER
INSTITUTE OF SCIENCE & TECHNOLOGY
Approved by AICTE, Affiliated to JNTUH, Hyd.



Date: 18/12/2019.

To
Dr V.N. Mani, Scientist-F
Center for Materials for Electronics & Technology (C-MET), Govt. of India
Hyderabad-500051

Mobile no. 7382489862

Dear Sir,

As you may be aware, we, MIST, are part of the reputed **MAHAVEER** group of educational institutions and have been in the service of imparting quality education to the society since 2001 i.e. last 18 years.

As part of our overall efforts to improve the outlook of students, we regularly invite scientists, engineers, technocrats, academicians and entrepreneurs of repute to visit our institute and share the latest technical developments and valuable learning's from their professional life with our students. As a part of this 'Invited Technical Lecture' series, many individuals of repute have already delivered lectures at our institute for the benefit of our students and faculty.

As you is a well-known expert with deep domain knowledge in the area of **DESIGN OF ELETRONICS DEVICES**. It would be a great pleasure to us in inviting you for delivering yours expert guest lectures to our students for the subject "**Advanced VLSI Technology**" approximately two hours duration in a day in every week during IInd Semester

We are thankful for accepting our request.

The following is the schedule of expert lectures on the subject:-
Every Saturday 3rd & 4th periods, except 2nd Sunday of month.

Thanking you,

*Invitation Accepted
& I shall deliver
the talk
18/12/2019.*

Yours sincerely,

HOD, ECE Department,
MIST.

Hyderabad,

Dr. V. N. MANI
Scientist-F
Center for Materials for Electronics Technology (C-MET)
Ministry of Electronics & Information Technology (MEO)
Govt. of India
1/6, Plot No. 5, Chaitanya, HCL, P.O.,
Hyderabad-500 051, Telangana State, India.

PRINCIPAL
MAHAVEER
INSTITUTE OF SCIENCE & TECHNOLOGY
Vysapuri, Bandlaguda Post, Keshavgi, Hyderabad-500 005

Mani
PRINCIPAL
MAHAVEER
INSTITUTE OF SCIENCE & TECHNOLOGY
Bandlaguda, Hyd-500 005

Vysapuri, Bandlaguda Post:Keshavgiri,

Hyderabad-500 005, TELANGANA INDIA
Tel: 040-64596979,8978380692.Fax: 040-24455003
E-mail: e3hod@gmail.com,
Website: www.mist.ac.in,

MAHAVEER

INSTITUTE OF SCIENCE & TECHNOLOGY

Approved by AICTE, Affiliated to JNTUH,Hyd.



DEPARTMENT OF ELECTRONICS AND COMMUNICATION ENGINEERING

SYLLABUS: ADVANCED VLSI DESIGN

- Digital Integrated Circuit Design
 - CMOS standard cell characteristics
 - Delay calculation (Elmore model, Logical Effort)
 - Low power design
 - Static Timing Analysis
 - Digital ASIC design flow
- Analog Integrated Circuit Design
 - Device Physics of the MOSFET
 - Physics Insights: MOSFET as a Switch
 - Analytical Techniques: Low and High frequency analysis, Noise analysis
 - Feedback
 - OPAMP Design
 - Oscillators and Phase Locked Loops
 - Analog Integrated Circuits Beyond Silicon
- Emerging Technologies
 - Open Source Processor Architecture (RISC-V)
 - Neuromorphic Computing
 - Edge Computing
 - Flexible Electronics
- Advanced Digital Design and FPGA based Design
 - VLSI Micro-architecture Design
 - Timing Closure
 - High Throughput Computing
 - FPGA Based System Design
 - Processor Design

Duration : 20 to 25 hrs /semester

Handwritten signature

PRINCIPAL
MAHAVEER
INSTITUTE OF SCIENCE & TECHNOLOGY
BANDLAGUDA, HYD-500 005.

Vysapuri, Bandlaguda Post, Keshavgi,ri,

Hyderabad-500 005, TELANGANA INDIA
Tel: 040-64596979,8978380692 Fax: 040-24455003
E-mail: e3hod.it@gmail.com,
Website: www.mist.ac.in,

MAHAVEER

INSTITUTE OF SCIENCE & TECHNOLOGY

Approved by AICTE, Affiliated to JNTUH,Hyd.



DEPARTMENT OF ELECTRONICS AND COMMUNICATION ENGINEERING

Date:20-12-2019

CIRCULAR

Technical Trainings on Advanced VLSI Design is starting from **23-12-2020** onwards. All the students IV year B. Tech should attend.

Design and development of curriculum for add-on courses :

Faculty Names: 1. Dr. Jaspal Kumar
2. Mr. Ch. Sandeep Kumar
3. Mrs. S Soujanya

HOD, ECE

Cc: Principal for information
: Coordinator to inform the students
: Notice board & department File.





PRINCIPAL
MAHAVEER
INSTITUTE OF SCIENCE & TECHNOLOGY
Bandlaguda, Hyd-500 005.

Vysapuri, Bandlaguda Post:Keshavgi,ri,

MAHAVEER

INSTITUTE OF SCIENCE & TECHNOLOGY

Approved by AICTE, Affiliated to JNTUH,Hyd



Hyderabad-500 005, TELANGANA INDIA

Tel: 040-64596979,8978380682,Fax: 040-24455003

E-mail: e3hod.it@gmail.com,

Website: www.mist.ac.in,

DEPARTMENT OF ELECTRONICS AND COMMUNICATION ENGINEERING

STUDENTS REGISTERED (AY 2019-20)

S.NO	H.T. NO.	NAME OF STUDENT
1	16E31A0401	ADARSHNA AKSHAYA
2	16E31A0402	AJNUGULA SWATHI
3	16E31A0403	ANAGOUNI SHIVANI GOUD
4	16E31A0405	ASHALA GANESH
5	16E31A0406	AVVARI BHARGAVI
6	16E31A0407	B NAVYA SRI
7	16E31A0408	HADAM SAI SHANKER
8	16E31A0410	BYREDDY SRIDEVI
9	16E31A0413	DESHAM PRIZITHIKA
10	16E31A0415	DHARAVATHI THARUN
11	16E31A0416	ENJAMURI PAVAN SAI PREETAM
12	16E31A0418	G HARISH
14	16E31A0420	HASBI SHREETHI
14	16E31A0421	JAGIDI VAMSHIKRISHNA
15	16E31A0422	KAKUSTAMPAYANI
16	16E31A0423	KALWA HARIKA
17	16E31A0425	KONAPARTHY ANJA CHARY
18	16E31A0427	KOTTALA VIKRAM
19	16E31A0428	KOYADA SWARNALATHA
20	16E31A0429	KULKARNI MANOJ
21	16E31A0430	LAGISHETTY ADITHYA
22	16E31A0433	MOHAMMAD AMEER EHAN
23	16E31A0435	PAKEER GANESH
24	16E31A0436	PANYALA NAVYASREE
25	16E31A0437	PAREDULA SHIVA TEJA
26	16E31A0438	PETA SAI TEJA
27	16E31A0439	POKURI SHEKAR
28	16E31A0440	PRAVALIKA GADAM
29	16E31A0442	RAPELLI TRAIKA
30	16E31A0443	SHAIK RASHEEDA BEGUM

K. Sankar
M. P. ...
INSTITUTE OF SCIENCE & TECHNOLOGY
Bandlaguda, Hyd-500 005

Vysapuri, Bandlaguda Post: Keshavgi,ri,

MAHAVEER

INSTITUTE OF SCIENCE & TECHNOLOGY

Approved by AICTE, Affiliated to JNTUH,Hyd.



Hyderabad-500 005, TELANGANA INDIA

Tel: 040-64596979,8978380692 Fax: 040-24455003

E-mail: e3hod_it@gmail.com,

Website: www.mist.ac.in,

DEPARTMENT OF ELECTRONICS AND COMMUNICATION ENGINEERING

31	16E31A0456	ASHBLASH REDDY KODKANTI
32	16E31A0457	AERUKALA SAI CHITRA
33	16E31A0459	ANANTHOU SHEVANI
34	16E31A0460	ANKAM SRIVARSHA
35	16E31A0461	ANNASONA SHALINI
36	16E31A0462	ANIAM BRAVANI
37	16E31A0463	ANUGONDA KIRAN KUMAR REDDY
38	16E31A0464	ANUMOLU NARENDRA SAI
39	16E31A0465	B PRADEEP
40	16E31A0466	BATTA SREE AMRUTH VAMSHI
41	16E31A0467	BIJALA SHRAVANI
42	16E31A0468	BODDUPALLI VAMSHIKRISHNA
43	16E31A0469	CH BUSHMITHA
43	16E31A0470	CHALLA VARUN REDDY
44	16E31A0471	CHEKKALA GANESH
45	16E31A0472	CHILUKA HARISH
46	16E31A0474	CHITTEPU PRI-MALATHA
47	16E31A0475	CHOLLETI KAVYA
48	16E31A0476	ELAGANDHALA VAMSHI PRANAY
49	16E31A0477	ELLENDULA VARSHITH
50	16E31A0478	GANGAREDDY MAHENDER

Kanthy

MAHAVEER
INSTITUTE OF SCIENCE & TECHNOLOGY
Bandlaguda, Hyd-500 005

Vysapuri, Bandlaguda Post:Keshavgiri,

MAHAVEER

INSTITUTE OF SCIENCE & TECHNOLOGY

Approved by AICTE, Affiliated to JNTUH,Hyd.



Hyderabad-500 005, TELANGANA INDIA

Tel: 040-64596979,8978380692 Fax: 040-24455003

E-mail: e3hod.it@gmail.com,

Website: www.mist.ac.in,

DEPARTMENT OF ELECTRONICS AND COMMUNICATION ENGINEERING

QUESTION PAPER

ADVANCED VLSI DESIGN

Duration:120Minutes

4 X 7.5= 30Marks

Answer the following all questions. Each question carries 7.5 marks.

1. Explain with neat diagram the architecture of FPGA.
2. Explain about wiring capacitance, fan in, fan out, choice of layers.
3. Discuss the advantages of SRAM over DRAM.
4. Compare CPLD and FPGA in all respects.

K. Sankar

PRINCIPAL
MAHAVEER
INSTITUTE OF SCIENCE & TECHNOLOGY
Bandlaguda, Hyd-500 005

Vysapuri, Bandlaguda Post:Keshavgi,

Hyderabad-500 005, TELANGANA INDIA
Tel: 040-64596979,8978380692, Fax: 040-24455003
E-mail: e3hod.its@gmail.com
Website: www.mist.ac.in,

MAHAVEER

INSTITUTE OF SCIENCE & TECHNOLOGY

Approved by AICTE, Affiliated to JNTUH,Hyd.



DEPARTMENT OF ELECTRONICS AND COMMUNICATION ENGINEERING

STUDENTS ATTENDANCE & RESULT (AY 2019-20)

S.NO.	H.T. NO.	NAME OF STUDENT	ATTENDANCE (30)HRS	MARKS OBTAINED(30)
1	16E31A0401	ADARSHNA AKSHAYA	17	27
2	16E31A0402	AENUGUILA SWATHI	18	24
3	16E31A0403	ANAGOUNI SREYANI GOUD	18	14
4	16E31A0405	ASHALA GANESH	20	25
5	16E31A0406	AVVADE BHARGAVI	13	25
6	16E31A0407	B NAVYA SRI	20	15
7	16E31A0408	BADAM SAI SHANKER	17	14
8	16E31A0410	BYREDDY SRIDEVI	20	22
9	16E31A0411	DESHAM PREETHIKA	20	26
10	16E31A0415	DHARAVATHI THARUN	20	ABSENT
11	16E31A0416	ENJAMORIPAVAN SAI PREETAM	17	26
12	16E31A0418	G HARISH	18	12
13	16E31A0420	HASBI SHRUTHI	18	22
14	16E31A0421	JAGIDI VAMSHIKRISHNA	20	23
15	16E31A0422	KAKUSTAM PAVANI	17	22
16	16E31A0423	KALWA HARIKA	20	25
17	16E31A0426	KONAPARTHY ANJACHARY	18	28
18	16E31A0427	KOTTALA VIKRAM	20	23
19	16E31A0428	KOYADA SWARNALATHA	19	29
20	16E31A0429	KULKARNI MANOJ	17	23
21	16E31A0430	LAGISHEETY ADITHYA	18	20
22	16E31A0432	MOHAMMAD AMEER KHAN	20	27
23	16E31A0435	PAKIEER GANESH	20	24
24	16E31A0436	PANYALA NAVYASREE	20	21
25	16E31A0437	PARIDULA SHIVA TEJA	20	28
26	16E31A0438	PETA SAI TEJA	18	25
27	16E31A0439	POKURI SHEKAR	19	20
28	16E31A0440	PRAVALIKA GADDAM	20	21
29	16E31A0442	RAPELI HARIKA	18	21
30	16E31A0443	SHAIK RASHEEDA BEGUM	20	22

Handwritten signature
PRINCIPAL

M
INSTITUTE OF SCIENCE & TECHNOLOGY
Bandlaguda, Hyd-500 005

Vysapuri, Bandlaguda Post:Keshavgi,

MAHAVEER

INSTITUTE OF SCIENCE & TECHNOLOGY

Approved by AICTE, Affiliated to JNTUH Hyd.



Hyderabad-500 005, TELANGANA INDIA

Tel: 040-64596979,8978380692 Fax: 040-24455003

E-mail: e3hod.it@gmail.com

Website: www.mist.ac.in

DEPARTMENT OF ELECTRONICS AND COMMUNICATION ENGINEERING

31	16E31A0456	ABHILASH REDDY KODIGANTI	17	23
32	16E31A0457	AERUKALA SAI CHITRA	18	22
33	16E31A0459	ANANTHOJU SHIVANI	18	25
34	16E31A0460	ANKAM SRIVARSHA	20	25
35	16E31A0461	ANNABOINA SHALINI	17	23
36	16E31A0462	ANNAM BRAVAN	30	29
37	16E31A0463	ANUGONDA KIRAN KUMAR REDDY	18	23
38	16E31A0464	ANUMOLI NARENDRA SAI	20	20
39	16E31A0465	B PRADEEP	18	27
40	16E31A0466	BATTA SREE AMRUTH VAMSHI	17	24
41	16E31A0467	BIJALA SHRAVANI	18	41
42	16E31A0468	BODDUPALLI VAMSHIKRISHNA	20	25
43	16E31A0469	CH BUSHMITHA	20	25
43	16E31A0470	CHALLA VARUN REDDY	20	20
44	16E31A0471	CHEKKALA GANESH	20	21
45	16E31A0472	CHILUKA HARISH	18	21
46	16E31A0474	CHITTEPUJ PREMALATHA	18	21
47	16E31A0475	CHOLLETTI KAVYA	20	23
48	16E31A0476	FLAGANDHALA VAMSHI PRANAY	18	22
49	16E31A0477	ELLENDULA VARSHITH	20	25
50	16E31A0479	GANGIREDDY MAHENDER	18	28

Handwritten signature

PRINCIPAL
MAHAVEER
INSTITUTE OF SCIENCE & TECHNOLOGY
Bandlaguda, Hyd-500005

STUDENTS REGISTERED ATTENDANCE & RESULT (AUG 2019-20)

Sl. No	HT. No	NAME OF STUDENT	A	A	M	1	2	3	4	5	6	7	8	9	10	11	12	13	14	15	16	17
1		ABHINAV	1	2	3	4	5	6	7	8	9	10	11	12	13	14	15	16	17	18	19	20
2		ABHINAV	1	2	3	4	5	6	7	8	9	10	11	12	13	14	15	16	17	18	19	20
3		ABHINAV	1	2	3	4	5	6	7	8	9	10	11	12	13	14	15	16	17	18	19	20
4		ABHINAV	1	2	3	4	5	6	7	8	9	10	11	12	13	14	15	16	17	18	19	20
5		ABHINAV	1	2	3	4	5	6	7	8	9	10	11	12	13	14	15	16	17	18	19	20
6		ABHINAV	1	2	3	4	5	6	7	8	9	10	11	12	13	14	15	16	17	18	19	20
7		ABHINAV	1	2	3	4	5	6	7	8	9	10	11	12	13	14	15	16	17	18	19	20
8		ABHINAV	1	2	3	4	5	6	7	8	9	10	11	12	13	14	15	16	17	18	19	20
9		ABHINAV	1	2	3	4	5	6	7	8	9	10	11	12	13	14	15	16	17	18	19	20
10		ABHINAV	1	2	3	4	5	6	7	8	9	10	11	12	13	14	15	16	17	18	19	20
11		ABHINAV	1	2	3	4	5	6	7	8	9	10	11	12	13	14	15	16	17	18	19	20
12		ABHINAV	1	2	3	4	5	6	7	8	9	10	11	12	13	14	15	16	17	18	19	20
13		ABHINAV	1	2	3	4	5	6	7	8	9	10	11	12	13	14	15	16	17	18	19	20
14		ABHINAV	1	2	3	4	5	6	7	8	9	10	11	12	13	14	15	16	17	18	19	20
15		ABHINAV	1	2	3	4	5	6	7	8	9	10	11	12	13	14	15	16	17	18	19	20
16		ABHINAV	1	2	3	4	5	6	7	8	9	10	11	12	13	14	15	16	17	18	19	20
17		ABHINAV	1	2	3	4	5	6	7	8	9	10	11	12	13	14	15	16	17	18	19	20
18		ABHINAV	1	2	3	4	5	6	7	8	9	10	11	12	13	14	15	16	17	18	19	20
19		ABHINAV	1	2	3	4	5	6	7	8	9	10	11	12	13	14	15	16	17	18	19	20
20		ABHINAV	1	2	3	4	5	6	7	8	9	10	11	12	13	14	15	16	17	18	19	20
21		ABHINAV	1	2	3	4	5	6	7	8	9	10	11	12	13	14	15	16	17	18	19	20
22		ABHINAV	1	2	3	4	5	6	7	8	9	10	11	12	13	14	15	16	17	18	19	20
23		ABHINAV	1	2	3	4	5	6	7	8	9	10	11	12	13	14	15	16	17	18	19	20
24		ABHINAV	1	2	3	4	5	6	7	8	9	10	11	12	13	14	15	16	17	18	19	20
25		ABHINAV	1	2	3	4	5	6	7	8	9	10	11	12	13	14	15	16	17	18	19	20
26		ABHINAV	1	2	3	4	5	6	7	8	9	10	11	12	13	14	15	16	17	18	19	20
27		ABHINAV	1	2	3	4	5	6	7	8	9	10	11	12	13	14	15	16	17	18	19	20
28		ABHINAV	1	2	3	4	5	6	7	8	9	10	11	12	13	14	15	16	17	18	19	20
29		ABHINAV	1	2	3	4	5	6	7	8	9	10	11	12	13	14	15	16	17	18	19	20
30		ABHINAV	1	2	3	4	5	6	7	8	9	10	11	12	13	14	15	16	17	18	19	20

Handwritten signature

29	GEETAJAGI	GEETAJAGI REDDY (SANT)	1	2	3	4	5	6	7	8	9	10	11	12	13	14	15	16	17	18	19	20
30	GEETAJAGI	ANURAGGA BUDHITHA	1	2	3	4	5	6	7	8	9	10	11	12	13	14	15	16	17	18	19	20
31	GEETAJAGI	ANURAGGA BUDHITHA	1	2	3	4	5	6	7	8	9	10	11	12	13	14	15	16	17	18	19	20
32	GEETAJAGI	ANURAGGA BUDHITHA	1	2	3	4	5	6	7	8	9	10	11	12	13	14	15	16	17	18	19	20
33	GEETAJAGI	ANURAGGA BUDHITHA	1	2	3	4	5	6	7	8	9	10	11	12	13	14	15	16	17	18	19	20
34	GEETAJAGI	ANURAGGA BUDHITHA	1	2	3	4	5	6	7	8	9	10	11	12	13	14	15	16	17	18	19	20
35	GEETAJAGI	ANURAGGA BUDHITHA	1	2	3	4	5	6	7	8	9	10	11	12	13	14	15	16	17	18	19	20
36	GEETAJAGI	ANURAGGA BUDHITHA	1	2	3	4	5	6	7	8	9	10	11	12	13	14	15	16	17	18	19	20
37	GEETAJAGI	ANURAGGA BUDHITHA	1	2	3	4	5	6	7	8	9	10	11	12	13	14	15	16	17	18	19	20
38	GEETAJAGI	ANURAGGA BUDHITHA	1	2	3	4	5	6	7	8	9	10	11	12	13	14	15	16	17	18	19	20
39	GEETAJAGI	ANURAGGA BUDHITHA	1	2	3	4	5	6	7	8	9	10	11	12	13	14	15	16	17	18	19	20
40	GEETAJAGI	ANURAGGA BUDHITHA	1	2	3	4	5	6	7	8	9	10	11	12	13	14	15	16	17	18	19	20
41	GEETAJAGI	ANURAGGA BUDHITHA	1	2	3	4	5	6	7	8	9	10	11	12	13	14	15	16	17	18	19	20
42	GEETAJAGI	ANURAGGA BUDHITHA	1	2	3	4	5	6	7	8	9	10	11	12	13	14	15	16	17	18	19	20
43	GEETAJAGI	ANURAGGA BUDHITHA	1	2	3	4	5	6	7	8	9	10	11	12	13	14	15	16	17	18	19	20
44	GEETAJAGI	ANURAGGA BUDHITHA	1	2	3	4	5	6	7	8	9	10	11	12	13	14	15	16	17	18	19	20
45	GEETAJAGI	ANURAGGA BUDHITHA	1	2	3	4	5	6	7	8	9	10	11	12	13	14	15	16	17	18	19	20
46	GEETAJAGI	ANURAGGA BUDHITHA	1	2	3	4	5	6	7	8	9	10	11	12	13	14	15	16	17	18	19	20
47	GEETAJAGI	ANURAGGA BUDHITHA	1	2	3	4	5	6	7	8	9	10	11	12	13	14	15	16	17	18	19	20

 HOD-ECE

 Co-ordinator.

Vysapuri, Bandlaguda Post:Keshavgiri,

Hyderabad-500 005, TELANGANA INDIA

Tel: 040-64596979,8978380692,Fax: 040-24455003

E-mail: e3hod.cse@gmail.com

Website: www.mist.ac.in

MAHAVEER

INSTITUTE OF SCIENCE & TECHNOLOGY

Approved by AICTE, Affiliated to JNTUH,Hyd.



DEPARTMENT OF COMPUTER SCIENCE AND ENGINEERING

Date: 03-02-2019

CIRCULAR

Technical Trainings for II & IV B. Tech students are starting from 17-02-2019 onwards. All HODs and placements coordinators have to manage the trainings and ensure 95% attendance all through the sessions.

All mentors need to send the compiled feedback report to HOD at e3hod.cse@gmail.com daily. Mentors are advised to take care of PNR (Students not participating in training).

Agenda: **Android mobile application**

HOD-CSE

K. Subbaraj
CIRCULAR
2019
2019

Vysapuri, Bandlaguda Post:Keshavgiri,

Hyderabad-500 005, TELANGANA INDIA
Tel: 040-64596979,8978380692,Fax: 040-24455003
E-mail: e3hod.cse@gmail.com,
Website: www.mist.ac.in,

MAHAVEER

INSTITUTE OF MANAGEMENT & TECHNOLOGY

Approved by AICTE, Affiliated to JNTUH,Hyd



DEPARTMENT OF COMPUTER SCIENCE AND ENGINEERING

SYLLABUS FOR Oracle Android Mobile Application

SNO	TOPIC COVERED	DURATION
1	Introduction to Android	4
2	Android Application Design and Resources	4
3	Exploring User Interfaces screen elements	4
4	Designing User Interfaces with Layouts	4
5	Drawing and working with Animation	3
6	Android Storage APIs	4
7	Sharing Data Between Applications with Content Providers	6
8	Using Android Network, Web and Multimedia APIs	8
9	Telephony API and Notifications	6
10	Introduction to application development for windows phone	5

HOD-CSE

K. Srinivas

10/10/2014
10/10/2014

Vysapuri, Bandlaguda Post:Keshavgiri,

MAHAVEER

INSTITUTE OF SCIENCE & TECHNOLOGY

Approved by AICTE, Affiliated to JNTUH,Hyd.



Hyderabad-500 005, TELANGANA INDIA

Tel: 040-64596979,8978380692. Fax: 040-24455003

E-mail: e3hod.cse@gmail.com,

Website: www.mist.ac.in,

DEPARTMENT OF COMPUTER SCIENCE AND ENGINEERING

LIST OF REGISTERED STUDENTS FOR Android Mobile Application

SNO	HALL TICKET NO	NAME OF THE STUDENT
1	16E31A0505	AVULA VAISHNAVI
2	16E31A0506	BADAM ABILASH
3	16E31A0508	BIJJUR VISHANTH REDDY
4	16E31A0512	GOPIREDDY ANKITH REDDY
5	16E31A0517	MOHD NAVEED AHMED
6	16E31A0522	M NIHARIKA
7	16E31A0524	MALGONDA POOJA
8	16E31A0525	MALKANNAGARI SRUJAY REDDY
9	16E31A0526	MANCHIKANTI SOUMYA
10	16E31A0527	MANGILIPELLY SAI KUMAR
11	16E31A0528	MARIKANTI HARIKA REDDY
12	16E31A0529	MD MASTAN
13	16E31A0531	MOHD FASIUDDIN
14	16E31A0532	MUDAVATH PAVAN KUMAR
15	16E31A0535	NATHI ALEKYA
16	16E31A0538	PAGALA KALYAN
17	16E31A0541	PAPINENI MANOJ KUMAR
18	16E31A0542	PEESU ANUDEEP
19	16E31A0543	PININTI RUCHITHA REDDY
20	16E31A0544	PUNNAM VINAY KUMAR

K. Subir

Principal
Date: _____
Signature: _____

Vysapuri, Bandlaguda Post,Keshavgiri,

MAHAVEER

INSTITUTE OF SCIENCE & TECHNOLOGY
Approved by AICTE, Affiliated to JNTUH,Hyd.



Hyderabad-500 005, TELANGANA INDIA
Tel: 040-64596979,8978380692 Fax: 040-24455003
E-mail: e3hod.cse@gmail.com
Website: www.mist.ac.in

DEPARTMENT OF COMPUTER SCIENCE AND ENGINEERING

21	16E31A0564	BOMMA NITIN
22	16E31A0565	BUDIGAM SANTHOSH
23	18E31A0551	AHSAN AHMED
24	18E31A0552	ASMA FARHEEN
25	18E31A0553	AZIZ UNNISA BEGUM
26	18E31A0554	BADUGU VARUN
27	18E31A0555	BAGGARI ADINARAYANA REDDY
28	18E31A0556	BALAI SRUJAN
29	18E31A0557	BASA HARSHA VARDHAN
30	18E31A0558	BOLLIKONDA AKHILA
31	18E31A0559	BUTTA BHARATH
32	18E31A0560	CHANDRACHARYA NITIN RAJU
33	18E31A0561	CHENUMALLA SAI PAVAN
34	18E31A0562	HAVARGE BASWARAJ
35	18E31A0563	JADI CHANDRADITYA
36	18E31A0570	MYAKA SRJA
37	18E31A0571	NANNEBOINA RENUSREE
38	18E31A0573	PADMAVATHI PALIWAL
39	18E31A0574	PANDALA NIKITHA
40	18E31A0575	PILLI NAGENDAR
41	18E31A0579	R SRINATH

Kishor

PRINCIPAL
MAHAVEER INSTITUTE OF SCIENCE & TECHNOLOGY
BANDLAGUDA POST, VYSAPURI, HYDRABAD-500 005

Vysapuri, Bandlaguda Post:Keshavgiri,

Hyderabad-500 005, TELANGANA INDIA
Tel: 040-64596979,8978380692,Fax: 040-24455003
E-mail: e3hod.cse@gmail.com,
Website: www.mist.ac.in,

MAHAVEER

INSTITUTE OF SCIENCE & TECHNOLOGY
Approved by AICTE, Affiliated to JNTUH,Hyd.



DEPARTMENT OF COMPUTER SCIENCE AND ENGINEERING

42	18E31A0580	RAPARTHI SANJANA
43	18E31A0581	RAVULAKOLLU NIKITHA
44	18E31A0582	RUMANLA KALYAN SAI
45	18E31A0594	WAJIDA SULTANA
46	18E31A0595	YADLAPALLI LIKHITH
47	18E31A0596	CHINNAWAR KAIWAL
48	18E31A0597	K RAMYA
49	18E31A0598	CHAVAKULA SIVA SANKAR

K. Suresh

Handwritten text and stamp at the bottom right, including a circular stamp with text and a date.

Vysapuri, Bandlaguda Post:Keshavgiri,

Hyderabad-500 005, TELANGANA INDIA

Tel: 040-64596979,8978380692 Fax: 040-24455003

E-mail: g3hod.cse@gmail.com,

Website: www.mist.ac.in.

MAHAVEER

INSTITUTE OF SCIENCE & TECHNOLOGY

Approved by AICTE, Affiliated to JNTUH,Hyd.



DEPARTMENT OF COMPUTER SCIENCE AND ENGINEERING

Android Mobile Application QUESTION PAPER

Duration: 120 Minutes

10 X 2 = 20 Marks

Answer the following all questions. Each question carries 2 marks.

1. What is Android?
2. What are the features of Android architecture?
3. List the languages used to build Android.
4. What is an activity?
5. What is a service in Android?
6. Differentiate Activities from Services.
7. What is Google Android SDK?
8. What is the use of Bundle in Android?
9. Describe the Android Framework?
10. What is the importance of having an emulator within the Android environment?

HOD-CSE

10/10/20
PRINCIPAL
MAHAVEER INSTITUTE OF SCIENCE & TECHNOLOGY
Bandlaguda - 500 005

Vysapuri, Bandlaguda Post:Keshavgi,

MAHAVEER



Hyderabad-500 005, TELANGANA INDIA

Tel: 040-64596979,8978380692 Fax: 040-24455003

E-mail: e3hod.cse@gmail.com

Website: www.mist.ac.in

Approved by AICTE, Affiliated to JNTUH,Hyd.

DEPARTMENT OF COMPUTER SCIENCE AND ENGINEERING

RESULT SHEET FOR ANDROID MOBILE APPLICATION REGISTERED STUDENTS

SNO	HALL TICKET NO	NAME OF THE STUDENT	MARKS (20)	RESULT
1	16E31A0505	AVULA VAISHNAVI	20	PASS
2	16E31A0506	BADAM ABILASH	19	PASS
3	16E31A0508	BIJJUR VISHANTH REDDY	20	PASS
4	16E31A0512	GOPIREDDY ANKITH REDDY	18	PASS
5	16E31A0517	MOHD NAVEED AHMED	20	PASS
6	16E31A0522	M NIHARIKA	20	PASS
7	16E31A0524	MALGONDA POOJA	16	PASS
8	16E31A0525	MALKANNAGARI SRUJAY REDDY	20	PASS
9	16E31A0526	MANCHIKANTI SOUMYA	20	PASS
10	16E31A0527	MANGILIPALLY SAI KUMAR	17	PASS
11	16E31A0528	MARIKANTI HARIKA REDDY	20	PASS
12	16E31A0529	MD MASTAN	20	PASS
13	16E31A0531	MOHD FASIUDDIN	16	PASS
14	16E31A0532	MUDAVATH PAVAN KUMAR	20	PASS
15	16E31A0535	NATHI ALEKYA	20	PASS
16	16E31A0538	PAGALA KALYAN	18	PASS
17	16E31A0541	PAPINENI MANOJ KUMAR	20	PASS
18	16E31A0542	PEESU ANUDEEP	19	PASS
19	16E31A0543	PININTI RUCHITHA REDDY	20	PASS
20	16E31A0544	PUNNAM VINAY KUMAR	18	PASS

K. K. K.
P.S.
M.P.
2023

Vysapuri, Bandlaguda Post:Keshavgi,

MAHAVEER



Hyderabad-500 005, TELANGANA INDIA

Tel: 040-64596979,8978380692, Fax: 040-24455003

E-mail: e3hod.cse@gmail.com,

Website: www.mist.ac.in,

Approved by AICTE, Affiliated to JNTUH,Hyd.

DEPARTMENT OF COMPUTER SCIENCE AND ENGINEERING

21	16E31A0564	BOMMA NITIN	20	PASS
22	16E31A0565	BUDIGAM SANTHOSH	20	PASS
23	18E31A0551	AHSAN AHMED	16	PASS
24	18E31A0552	ASMA FARHEEN	20	PASS
25	18E31A0553	AZIZ UNNISA BEGUM	19	PASS
26	18E31A0554	BADUGU VARUN	20	PASS
27	18E31A0555	BAGGARI ADINARAYANA REDDY	18	PASS
28	18E31A0556	BALAJI SRUJAN	20	PASS
29	18E31A0557	BASA HARSHA VARDHAN	20	PASS
30	18E31A0558	BOLLIKONDA AKHILA	16	PASS
31	18E31A0559	BUTTA BHARATH	20	PASS
32	18E31A0560	CHANDRACHARYA NITIN RAJU	20	PASS
33	18E31A0561	CHENUMALLA SAI PAVAN	17	PASS
34	18E31A0562	HAVARGE BASWARAJ	20	PASS
35	18E31A0563	JADI CHANDRADITYA	20	PASS
36	18E31A0570	MYAKA SRIJA	16	PASS
37	18E31A0571	NANNEBOINA RENUSREE	20	PASS
38	18E31A0573	PADMAVATHI PALIWAL	20	PASS
39	18E31A0574	PANDALA NIKITHA	18	PASS
40	18E31A0575	PILLI NAGENDAR	20	PASS
41	18E31A0579	R SRINATH	19	PASS

K. Srinath

PPH/2021
21
MISTP
S. Srinath

Vysapuri, Bandlaguda Post:Keshavgiri,

Hyderabad-500 005, TELANGANA INDIA
Tel: 040-64596979,8978380692,Fax: 040-24455003
E-mail: e3hod.cse@gmail.com,
Website: www.mist.ac.in,

MAHAVEER

INSTITUTE OF TECHNOLOGY
Approved by AICTE, Affiliated to JNTUH,Hyd.



DEPARTMENT OF COMPUTER SCIENCE AND ENGINEERING

42	18E31A0580	RAPARTHI SANJANA	20	PASS
43	18E31A0581	RAVULAKOLLU NIKITHA	18	PASS
44	18E31A0582	RUMANLA KALYAN SAI	20	PASS
45	18E31A0594	WAJIDA SULTANA	20	PASS
46	18E31A0595	YADLAPALLI LIKHITH	16	PASS
47	18E31A0596	CHINNAWAR KAIWAL	20	PASS
48	18E31A0597	K RAMYA	20	PASS
49	18E31A0598	CHAVAKULA SIVA SANKAR	16	PASS

No. of students Registered:49
No. of students Passed:49
No. of students failed:NIL

Khanif

PRINCIPAL
MAHAVEER
INSTITUTE OF TECHNOLOGY
HYDRAABAD

Vysapuri, Bandlaguda Post:Keshavgiri,

MAHAVEER



Hyderabad-500 005, TELANGANA INDIA

Tel: 040-64596979,8978380692, Fax: 040-24455003

E-mail: e3hod.cse@gmail.com.

Website: www.mist.ac.in,

Approved by AICTE, Affiliated to JNTUH,Hyd.

DEPARTMENT OF COMPUTER SCIENCE AND ENGINEERING

SUMMARY REPORT OF Android Mobile Application

It is currently used in various devices such as mobiles, tablets, televisions etc. Android provides a rich application framework that allows us to build innovative apps and games for mobile devices in a Java language environment.

Presently, the use of mobile apps can be seen in areas such as communication, education, cooking, social media, shopping, business (money making), matrimony, and banking. On daily basis individuals seek for updated versions of these apps.

Among the various Application categories developed by us on the android platform, some of them are; Communication Application, Business Application, Multimedia Application, Internet Application, Fun/Entertainment Application, Gaming Application, Utility and Security Application..

COORDINATOR

Copy to:

1. Department Notice Board
2. Principal for Information
3. Committee Members (Academic)

K. Srinivas

PRINCIPAL
MAHAVEER
WINDMILL ROAD, BANDLAGUDA
MIDDLE STAGE, HYDRABAD-500 005.

Yysapuri, Bandlaguda Post:Keshavgiri,

Hyderabad-500 005, TELANGANA INDIA
Tel: 040-64596979,8978380692,Fax: 040-24455003
E-mail: e3hod.it@gmail.com,
Website: www.mist.ac.in,

MAHAVEER

INSTITUTE OF SCIENCE & TECHNOLOGY

Approved by AICTE, Affiliated to JNTUH.Hyd.



DEPARTMENT OF INFORMATION TECHNOLOGY

Date:25-08-2019

To,

The principal,
MIST,
Hyderabad.

Sub: Proposal for Add-on Course-Reg.

Dear Sir,

We are going to conduct two weeks workshop on **Android Application Development**. We require your approval to go head for further proceeding and hope to get an opportunity to serve you the best.

With thanks and Regards

[Handwritten Signature]
NOD

[Handwritten Signature]
MAHAVEER
INSTITUTE OF SCIENCE & TECHNOLOGY
Bandlaguda, Hyderabad-500 005.

19/08/2019

Vysapuri, Bandlaguda Post:Keshavgiri,

Hyderabad-500 005, TELANGANA INDIA
Tel: 040-64596979,8978380692,Fax: 040-24455003
E-mail: e3hod.it@gmail.com,
Website: www.mist.ac.in,

MAHAVEER

INSTITUTE OF SCIENCE & TECHNOLOGY
Approved by AICTE, Affiliated to JNTUH,Hyd.



DEPARTMENT OF INFORMATION TECHNOLOGY

Date: 02-09-2019

CIRCULAR

Technical Trainings for III & IV B. Tech students are starting from **16-09-2019** onwards. All HODs and placements coordinators have to manage the trainings and ensure 95% attendance all through the sessions.

All mentors need to send the compiled feedback report to HOD at e3hod@gmail.com daily. Mentors are advised to take care of PNR (Students not participating in training).

Agenda: **Android Application Development**

Design and Development of Curriculum for Add on Course:

Name of the Faculty: 1.Dr.A.NANDA GOPAL REDDY
2.K.B.V.K NAGASREE
3.V.NARESH KUMAR REDDY

Kanthy
PRINCIPAL
MAHAVEER
INSTITUTE OF SCIENCE & TECHNOLOGY
Bandlaguda, Hyd-500 005.

A. Reddy
HOD

Dr.A.Nanda Gopal Reddy
HOD, Dept. of Information Technology
Mahaveer Institute of Science & Technology
Bandlaguda, Post:Keshavgiri,
Hyderabad-500005.

Vysapuri, Bandlaguda Post:Keshavnagar,

Hyderabad-500 005, TELANGANA INDIA
Tel: 040-64596979,8978380092,Fax: 040-24455003
E-mail: u3hod.it@gmail.com,
Website: www.mist.ac.in,

MAHAVEER

INSTITUTE OF SCIENCE & TECHNOLOGY
Approved by AICTE, Affiliated to JNTU(H),Hyd.



DEPARTMENT OF INFORMATION TECHNOLOGY

LIST OF REGISTERED STUDENTS FOR Android Application Development

SNO	HALL TICKET NO	NAME OF THE STUDENT
1	16E31A1202	ADITHYAN PAVAN
2	16E31A1203	ADITHYAN PRANAV
3	16E31A1204	ANDE NAVJEN KUMAR
4	16E31A1206	CHIDAMBARI CHAITANYA
5	16E31A1207	CHIDAMBARI ANSHWEE
6	16E31A1208	DEVARANI DEEPAK
7	16E31A1211	GOLI ARUN KUMAR
8	16E31A1212	KARUN CHINMI
9	16E31A1213	KERRE SAI KRISHNA
10	16E31A1214	KURVA VAINAVI
11	16E31A1217	NANDIKANTI TEJASWINI
12	16E31A1218	PADALA NAVIKANTH CHARY
13	16E31A1219	PADALI SRI PAVAN
14	16E31A1220	PEDESE EYANAGA ANUSHA
15	16E31A1221	PERUMALLA KRANTHI KUMAR
16	16E31A1223	R VAINAVI
17	16E31A1224	SAMRITH SULTANA
18	16E31A1225	SRIHARA GAYATHRI
19	16E31A1227	THADIPARTHI TEJASWINI
20	16E31A1228	VADHABHYA SRINA
21	16E31A1229	VATHIKOTI MAHESH
22	16E31A1230	VITHAL PAVAN REDDY
23	16E31A1231	VASA ABHINAYA
24	17E31A1201	AKULA SAI JAHNAVI
25	17E31A1203	BAINGAR DEVI PRASAD
26	17E31A1205	BHARADWAJ ACHIT
27	17E31A1206	BOLLA KRAN KUMAR
28	17E31A1207	C PRASHANSHA
29	17E31A1208	CEELA MAHESH
30	17E31A1209	GANDHAM SHYAMALA
31	17E31A1210	KAVATI VINITHA
32	17E31A1211	KAKANI HIMABINDU
33	17E31A1212	KANDUKURI VINITHA
34	17E31A1213	LAKSHIKA PAREEK
35	17E31A1214	LOKA SAMITHA
36	17E31A1215	MADISHETTY HIRAVYA SRI
37	17E31A1217	MARAM AKSHITHA
38	17E31A1218	MEKA SRIKRISHNA
39	17E31A1219	MIRYALA MDUNIKA
40	17E31A1220	MOHAMMED ABDUL RAZZAK

Kanthy
PROFESSOR
MIST - MAHAVEER
INSTITUTE OF SCIENCE & TECHNOLOGY
Hyderabad

Vysapuri, Bandlaguda Post:Keshavgirl,

Hyderabad-500 005, TELANGANA INDIA
Tel: 040-64596979,8978380692,Fax: 040-24455003
E-mail: e3hod.it@gmail.com,
Website: www.mist.ac.in,

MAHAVEER

INSTITUTE OF SCIENCE & TECHNOLOGY

Approved by AICTE, Affiliated to JNTUH,Hyd.



DEPARTMENT OF INFORMATION TECHNOLOGY

41	17E31A1221	MOHAMMED JAWAD
42	17E31A1222	MOHD HUSSAIN UDDIN
43	17E31A1223	MOHD MOIN UDDIN SIDDIQUI
44	17E31A1227	PATHA SAIKIRAN
45	17E31A1229	RAVUTLA PRANEETH
46	17E31A1230	SAMA NAVYA
47	17E31A1231	TUMMA NISHANTH KUMAR
48	17E31A1232	VIDHYADAR SHARMA P
49	17E31A1233	YASMEEN BEGUM
50	16E31A1215	MOHD SALMAN

Handwritten signature in black ink.

Handwritten signature in green ink.

PRINCIPAL
MAHAVEER
INSTITUTE OF SCIENCE & TECHNOLOGY
Bandlaguda, Hyderabad-500 005.

Vysapuri, Bandlaguda Post:Keshavgiri,

Hyderabad-500 005, TELANGANA INDIA

Tel: 040-64596979,8978380692,Fax: 040-24455903

E-mail: e3hod.it@gmail.com,

Website: www.mist.ac.in,

MAHAVEER

INSTITUTE OF SCIENCE & TECHNOLOGY

Approved by AICTE, Affiliated to JNTUH,Hyd.



DEPARTMENT OF INFORMATION TECHNOLOGY

Android Application Development QUESTION PAPER

Duration: 120 Minutes

10 X 2 = 20 Marks

Answer the following all questions. Each question carries 2 marks.

1. What is Android?
2. What is the Android SDK?
3. What is the difference between Mobile Application Testing and Mobile Testing?
4. Name the languages supported for Android development.
5. What are the advantages of the Android Operating System?
6. Explain Android Architecture briefly.
7. Define and explain the Android Framework.
8. Provide the important core components of Android.
9. What is meant by Services?
10. Explain Activity Lifecycle briefly.

Principals
Principals
Info-IT

Principals
PRINCIPAL
MAHAVEER
INSTITUTE OF SCIENCE & TECHNOLOGY
Bandlaguda, Hyd-500 005.

Vysapuri, Bandlaguda Post:Keshavgiri,

Hyderabad-500 005, TELANGANA INDIA
Tel: 040-64596979,8978380692 Fax: 040-24455003
E-mail: e3hod.it@gmail.com,
Website: www.mist.ac.in,

MAHAVEER

INSTITUTE OF SCIENCE & TECHNOLOGY
Approved by AICTE, Affiliated to JNTUH,Hyd



DEPARTMENT OF INFORMATION TECHNOLOGY

RESULT SHEET FOR Android Application Development REGISTERED STUDENTS

SNO	HALL TICKET NO	NAME OF THE STUDENT	MARKS (20)	RESULT
1	16E31A1202	ADURLA PAVAN	20	PASS
2	16E31A1203	AKULA PRANATHI	19	PASS
3	16E31A1204	ANDE NAVEEN KUMAR	20	PASS
4	16E31A1206	CHENNUPATI CHAITANYA	18	PASS
5	16E31A1207	CHIDIMILLA ASHWIDHI	20	PASS
6	16E31A1208	DEVARANENI SANJAY	20	PASS
7	16E31A1211	GOLLABUN KUMAR	16	PASS
8	16E31A1212	KARUNG DENESH	20	PASS
9	16E31A1213	KEERTHI SAI KRISHNA	20	PASS
10	16E31A1214	KURUVA VAISHNAVI	17	PASS
11	16E31A1217	NANDIKANTI TEJASWINI	20	PASS
12	16E31A1218	PADALA NAVIKANTHI CHARY	20	PASS
13	16E31A1219	PAIPATI SHILPA REDDY	16	PASS
14	16E31A1220	PEDDISSETTY NAGA ANUSHA	20	PASS
15	16E31A1221	PERUMALLA KRANTHI KUMAR	20	PASS
16	16E31A1223	R VAISHNAVI	18	PASS
17	16E31A1224	SAMREEN SULTANA	20	PASS
18	16E31A1225	SRIDHARA GAVATHRI	19	PASS
19	16E31A1227	THADIPARTHI THEJASWINI	20	PASS
20	16E31A1228	VADHADIYA SRINA	18	PASS
21	16E31A1229	VATIKUTI MAHESH	20	PASS
22	16E31A1230	VITTEDI PAVAN REDDY	20	PASS
23	16E31A1231	YASA ABHINAYA	16	PASS
24	17E31A1201	AKULA SAIJENNAVI	20	PASS
25	17E31A1203	BAINGAR HARU PRASAD	19	PASS
26	17E31A1205	BHARADWAJ AJITH	20	PASS
27	17E31A1206	BOLLA KIRAN KUMAR	18	PASS
28	17E31A1207	C PRASHANSHA	20	PASS
29	17E31A1208	CEELA MAHESH	20	PASS
30	17E31A1209	GANDHAM SHYAMALA	16	PASS
31	17E31A1210	KAAVATI VINEETHA	20	PASS
32	17E31A1211	KAKANI HIMA BINDU	20	PASS
33	17E31A1212	KANDUKURI VINITHA	17	PASS
34	17E31A1213	LAKSHIKA PAREEK	20	PASS
35	17E31A1214	LOKA SAMHITHA	20	PASS
36	17E31A1215	MADISHETTY BHAVYA SRI	16	PASS
37	17E31A1217	MARAM AXSHITHA	20	PASS
38	17E31A1218	MEKA SRIKRISHNA	20	PASS
39	17E31A1219	MIRYALA MOUNIKA	18	PASS

Kanby
PRINCIPAL
MAHAVEER
INSTITUTE OF SCIENCE & TECHNOLOGY
Bandlaguda, Hyd.

Vysapuri, Bandlaguda Post:Keshavgiri,

Hyderabad-500 005, TELANGANA INDIA
Tel: 040-64596979,8978380692.Fax: 040-24455003
E-mail: e3hod.it@gmail.com,
Website: www.mist.ac.in,

MAHAVEER

INSTITUTE OF SCIENCE & TECHNOLOGY

Approved by AICTE, Affiliated to JNTUH,Hyd.



DEPARTMENT OF INFORMATION TECHNOLOGY

40	17E31A1220	MOHAMMED ABDUL RAZZAK	20	PASS
41	17E31A1221	MOHAMMED JAWAD	19	PASS
42	17E31A1222	MOHD HUSSAIN UDDIN	20	PASS
43	17E31A1223	MOHD MOIN UDDIN SIDDIQUI	18	PASS
44	17E31A1227	PATHA SAIKIRAN	20	PASS
45	17E31A1229	RAVUTLA PRANEETH	20	PASS
46	17E31A1230	SAMA NAVYA	16	PASS
47	17E31A1231	TUMMA NISHANTH KUMAR	20	PASS
48	17E31A1232	VIDHYADAR SHARMA P.	20	PASS
49	17E31A1233	YASMEEN BEGUM	20	PASS
50	16E31A1215	MOHD SALMAN	18	PASS

No. of students Registered:50

No. of students Passed:50

No. of students failed:NIL

Dr. A. Nanda Chandra Prasad
HOD, Dept of Information Technology
Mahaveer Institute of Science & Technology
Vysapur, Bandlaguda Post, Keshavgiri
Hyderabad-500005

Kanthy
PRINCIPAL
MAHAVEER
INSTITUTE OF SCIENCE & TECHNOLOGY
Bandlaguda, Hyd-500 005.

Vysapuri, Bandlaguda Post:Keshavgi,

Hyderabad-500 005, TELANGANA INDIA
Tel: 040-64596979,8978380692,Fax: 040-24455003
E-mail: e3hod.it@gmail.com,
Website: www.mist.ac.in,

MAHAVEER

INSTITUTE OF SCIENCE & TECHNOLOGY
Approved by AICTE, Affiliated to JNTUH,Hyd.



DEPARTMENT OF INFORMATION TECHNOLOGY

SUMMARY REPORT OF Android Application Development

Android apps have transformed the mobile app market.

There is a broad range of applications of Android app, particularly in the business world.

When it comes to the development of Android app, certain things need to be deemed.

The expectations of the customers, demands of the business, the workflow of the business, the requirements of the employees and group members, etc. need to be think about before app development.

Best Android apps can simply be created with diverse app-creation platforms or through traditional app development. Android app development can assist a business in reaching out to more customers, improve its sales, improve its brand image and create a loyal customer base.

It can lay the base for the success of any business.

COORDINATOR

Copy to:

1. Department Notice Board
2. Principal for Information
3. Committee Members (Academic)

PRINCIPAL
MAHAVEER
INSTITUTE OF SCIENCE & TECHNOLOGY
Bandlaguda, Hyd-500 005

MAHATMA INSTITUTE OF SCIENCE & TECHNOLOGY
DEPARTMENT OF INFORMATION TECHNOLOGY
Android Application Development ATTENDANCE SHEET

SNO	NO	NAME OF THE STUDENT	Date																							
			16	17	18	19	20	21	22	23	24	25	26	27	28	29	30	31	01	02	03	04	05	06		
1	16E31A1202	ADURLA PAVAN	P	P	P	P	P	A	P	A	P	P	P	A	P	P	P	A	P	P	P	P	P	P		
2	16E31A1203	AKULA PRANATHI	P	P	P	A	P	P	P	P	A	P	P	P	P	P	P	P	P	P	P	P	P	P		
3	16E31A1204	ANDE NAVI EN KUMAR	P	A	P	P	A	P	P	P	P	A	P	P	P	P	P	P	P	P	P	P	P	P		
4	16E31A1206	CHENNUPATI CHAITANYA	A	P	P	P	P	A	P	P	P	P	P	P	P	P	P	P	P	P	P	P	P	P		
5	16E31A1207	CHIDMILLA ASHWITHI	P	A	P	P	A	P	P	P	A	P	P	P	P	P	P	P	P	P	P	P	P	P		
6	16E31A1208	DEVARANI SE SANJAY	P	A	P	P	P	P	P	P	P	P	P	P	P	P	P	P	P	P	P	P	P	P		
7	16E31A1211	GOLAMUN LUMAR	P	P	P	P	P	P	P	P	P	P	P	P	P	P	P	P	P	P	P	P	P	P		
8	16E31A1212	KARING DENESI	A	P	P	P	P	A	P	P	P	P	P	P	P	P	P	P	P	P	P	P	P	P		
9	16E31A1213	ELERTHESAI KRISHNA	P	P	P	P	P	P	P	P	P	P	P	P	P	P	P	P	P	P	P	P	P	P		
10	16E31A1214	KULIYA VAISHNAVI	P	P	P	P	P	P	P	P	P	P	P	P	P	P	P	P	P	P	P	P	P	P		
11	16E31A1217	NANDIKANTI TEJASWINI	A	P	P	P	P	P	P	P	P	P	P	P	P	P	P	P	P	P	P	P	P	P		
12	16E31A1218	PADALA NAVIKANTH UJURY	P	P	P	P	P	P	P	P	P	P	P	P	P	P	P	P	P	P	P	P	P	P		
13	16E31A1219	PAPATI NHELPA REDDI	A	P	P	P	P	P	P	P	P	P	P	P	P	P	P	P	P	P	P	P	P	P		
14	16E31A1220	PEDDSETTY NAGARAJUSHA	P	P	P	P	P	P	P	P	P	P	P	P	P	P	P	P	P	P	P	P	P	P		
15	16E31A1221	PERUMALLA KRANTI DEEJAN	P	A	P	P	P	P	P	P	P	P	P	P	P	P	P	P	P	P	P	P	P	P		
16	16E31A1223	R VAISHNAVI	P	P	P	P	P	P	P	P	P	P	P	P	P	P	P	P	P	P	P	P	P	P		
17	16E31A1224	SAMREEN SULTANA	A	P	P	P	P	P	P	P	P	P	P	P	P	P	P	P	P	P	P	P	P	P		
18	16E31A1225	SRIDEBARA GAYATHRI	P	P	P	P	P	P	P	P	P	P	P	P	P	P	P	P	P	P	P	P	P	P		
19	16E31A1227	THADIPATI DEEJASWANI	P	P	P	P	P	P	P	P	P	P	P	P	P	P	P	P	P	P	P	P	P	P		
20	16E31A1228	VADDEADIYA SRINA	P	P	P	P	P	P	P	P	P	P	P	P	P	P	P	P	P	P	P	P	P	P		
21	16E31A1229	VATIKUTHI MAHESH	P	P	P	P	P	P	P	P	P	P	P	P	P	P	P	P	P	P	P	P	P	P		
22	16E31A1230	VITTEDE PAVAN REDDY	P	P	P	P	P	P	P	P	P	P	P	P	P	P	P	P	P	P	P	P	P	P		
23	16E31A1231	YASA ABHINAVA	P	P	P	P	P	P	P	P	P	P	P	P	P	P	P	P	P	P	P	P	P	P		
24	17E31A1201	AKULA SAJJANAVI	P	P	P	P	P	P	P	P	P	P	P	P	P	P	P	P	P	P	P	P	P	P		
25	17E31A1203	DAINGAR HARU PRASAD	P	P	P	P	P	P	P	P	P	P	P	P	P	P	P	P	P	P	P	P	P	P		
26	17E31A1205	BHARADWAJ ARITHI	P	A	P	P	P	P	P	P	P	P	P	P	P	P	P	P	P	P	P	P	P	P		
27	17E31A1206	BOLLA KIRAN KUMAR	A	P	P	P	P	P	P	P	P	P	P	P	P	P	P	P	P	P	P	P	P	P		
28	17E31A1207	C PRASHANNA	A	P	P	P	P	P	P	P	P	P	P	P	P	P	P	P	P	P	P	P	P	P		

PRINCIPAL
MAHATMA INSTITUTE OF SCIENCE & TECHNOLOGY
 Hyderabad, Andhra Pradesh, India-500 005.



MAHVEER INSTITUTE OF SCIENCE & TECHNOLOGY

Approved by AICTE, Affiliated to JNTU, Hyderabad.

Vyasapuri, Bandlaguda, Post: Keshavnagar, Hyderabad - 500003



DEPARTMENT OF INFORMATION TECHNOLOGY

CERTIFICATE

This is to certify that **BAINGAR HARI PRASAD** bearing Hall Ticket No **17E31A1203** of **B.Tech Third Year** has participated In **Android Application Development** training Program From **16-09-2019** to **28-09-2019** organized by Dept. of **INFORMATION TECHNOLOGY**.

ESTD - 2001

Dr. Nandan Gopal Reddy
HOD

Puja Bhatia
Director/Webtek Labs. Pvt. Ltd.

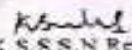
Dr. K. S. S. N. Reddy
PRINCIPAL

Handwritten signature and stamp in green ink, partially overlapping the bottom edge of the certificate.

About the College

As an Institute committed in quality education, MIST aims at providing learning with a technology edge. It endeavors to provide consistent training so its students to help them evolve as competent professionals in the highly competitive world. Right from its inception in 2001, it has been tuning itself to meet this objective. New civilization is emerging in our lives. This civilization brings with it a new way of working. Millions are already tuning their lives to the rhythms of tomorrow.

About IT Dept.

The Department of IT applies the depth of knowledge of students effectively which meets the highest level of competency required by the industry. With its experienced faculty members having excellent academic backgrounds, it trains students supplementing their own lectures with computer-aided demonstrations making their learning a rich and rewarding experience.

About the Course

This course will teach you the basic implementation of concepts in this course, you will learn about Android, which also includes how to download the software and how to install it. You will use phone that emulator where in you will run your application. Again, this course contains two simple applications based on the things you learned in this course.

Organising committee

CHIEF PATRON

Smt. S. Jayalakshmi Reddy
Chairman

Sri S. Sundar Reddy

Secretary

Sri S. Dhanunjay Reddy

Joint Secretary

DIRECTOR

Dr. H. S. N. Murthy

PATRON

Dr. KSSN Reddy, Principal

CONVENER

Dr. Nandagopal Reddy, Asso. Prof.

Dept. OIT

TECHNICAL COORDINATORS

Mr. V. Naresh Kumar Reddy

Mrs. KRVR Nageswari



MAHAVEER

INSTITUTE OF SCIENCE & TECHNOLOGY

Approved by AICTE, Affiliated to JNTU, Hyderabad

2015-2017

Autonomous Engineering, B.Tech. Courses, Government Degree College



Two week
Certification Course
on

ANDROID APPLICATION DEVELOPMENT

Organized by

Department of
Information Technology

Handwritten signature
Dr. H. S. N. Murthy
Principal

Schedule

Day 1 : Basic Android Concepts

Day 2 : Using more Android capabilities

Day 3 : Working with files

Day 4 : Android SDK

Day 5 : Android Architecture

Day 6 : Android Framework

Day 7 : Components of Android

Day 8 : Android with Database

Day 9 : Dialog Boxes

Day 10 : Android Interface Definition Language

Day 11 : Android Manifest.xml

Contact details

B.Mallaiah : 9640199536

S. Sunil : 8217038532

Who can attend

3rd and Final Year IT students

Date: 16-09-2019 onwards

Time:

10am - 11:30am

12pm - 1:30pm

Place: MIST

NOTE - Participation Certificate will be given

Resource person

P.Vinaya Sree

M.Tech

Assistant Professor

Department of CSE

Anurag University

HV Ramana Rao

M.Tech(Ph.D)

Assistant Professor

Department of CSE

CMR Institute of Technology

S. Venkateshwara Rao

M.Tech(Ph.D)

Associate Professor

Department of CSE

Megha Institute of Engineering & Technology

B.Naresh Goud

M.Tech

Assistant Professor

Department of CSE

TKR College of Engineering & Technology

K. Srinivas
PROFESSOR
M.A. 11/2/19
M.Tech (Ph.D) in CSE
Department of CSE
TKR College of Engineering & Technology

Vysapuri, Bandlaguda Post: Keshavgirl,

Hyderabad-500 005, TELANGANA INDIA

Tel: 040-64500379, 8978380092 Fax: 040-24455003

E-mail: q3hod.it@gmail.com

Website: www.mist.ac.in

MAHAVEER

INSTITUTE OF SCIENCE & TECHNOLOGY

Approved by AICTE, Affiliated to JNTUH, Hyd.



DEPARTMENT OF INFORMATION TECHNOLOGY

Date: 01-02-2020

To,

The principal,
MIST,
Hyderabad.

Sub: Proposal for Add-on Course-Reg.

Dear Sir,

We are going to conduct two weeks workshop on Oracle Java Certification. We require your approval to go head for further proceeding and hope to get an opportunity to serve you the best.

With thanks and Regards

Dr. A. Neelakrishna Reddy
HOD, Dept. of Information Technology
Mahaveer Institute of Science & Technology
Bandlaguda, Hyd-500 005

Kshalya
PRINCIPAL
MAHAVEER
INSTITUTE OF SCIENCE & TECHNOLOGY
Bandlaguda, Hyd-500 005

Vysapuri, Bandlaguda Post:Keshavgi.

Hyderabad-500 005, TELANGANA INDIA
Tel: 040-64596979,8978380692 Fax: 040-24455003
E-mail: e3hod_it@gmail.com
Website: www.mist.ac.in.

MAHAVEER

INSTITUTE OF SCIENCE & TECHNOLOGY

Approved by AICTE, Affiliated to JNTUH, Hyd.



DEPARTMENT OF INFORMATION TECHNOLOGY

Date: 03-02-2020

CIRCULAR

Technical Trainings for II & IV B, Tech students are starting from 17-02-2020 onwards. All HODs and placements coordinators have to manage the trainings and ensure 95% attendance all through the sessions.

All mentors need to send the compiled feedback report to HOD at e3hod_it@gmail.com daily. Mentors are advised to take care of PNR (Students not participating in training).

Agenda: Oracle Java Certification

Design and Development of Curriculum for Add on Course:

Name of the Faculty: 1.Dr.A.NANDA GOPAL REDDY
2.S.SRINIVAS
3.B.MALLAIAH

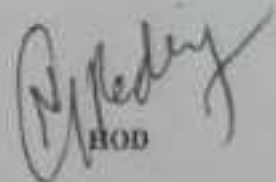
HOD

Kanishk
PRINCIPAL
MAHAVEER
INSTITUTE OF SCIENCE & TECHNOLOGY
Bandlaguda, Hyderabad-500 005

Hyderabad-500 005

Vysapuri, Bandlaguda Post, Keshavnagar,

Hyderabad-500 005, TELANGANA INDIA
Tel: 040-64596979, 8978380692, Fax: 040-24455093
E-mail: edhod.it@gmail.com,
Website: www.mist.ac.in,

MAHAVEER

INSTITUTE OF SCIENCE & TECHNOLOGY

Approved by AICTE, Affiliated to JNTUH, Hyd.



DEPARTMENT OF INFORMATION TECHNOLOGY

SYLLABUS FOR Oracle Java Certification

SNO	TOPIC COVERED	DURATION
1	Writing Basic SQL SELECT Statements	3
2	Restricting and Sorting Data	3
3	Displaying Data from Multiple Tables	3
4	Creating and Managing Tables	3
5	Including Constraints	3
6	Creating Views	3
7	Creating and Running PL/SQL Code	3
8	Exception Handlers	3
9	Procedures	3
10	Functions	3
11	Parameters	3
12	Packages	3
13	Triggers	3

Dr. A. N. S. Reddy
MAHAVEER
INSTITUTE OF SCIENCE & TECHNOLOGY
Vysapuri, Bandlaguda Post, Keshavnagar,
Hyderabad-500 005, TELANGANA INDIA

Dr. A. N. S. Reddy
HOD, Dept. of Information Technology
Mahaveer Institute of Science & Technology
Vysapuri, Bandlaguda Post, Keshavnagar,
Hyderabad-500 005, TELANGANA INDIA

Vysapuri, Bandlaguda Post, Keshavgi,

Hyderabad-500 005, TELANGANA INDIA
Tel: 040-64596979,8978380682, Fax: 040-24455003
E-mail: a3hod.it@gmail.com,
Website: www.mist.ac.in,

MAHAVEER

INSTITUTE OF SCIENCE & TECHNOLOGY

Approved by AICTE, Affiliated to JNTUH,Hyd.



DEPARTMENT OF INFORMATION TECHNOLOGY

LIST OF REGISTERED STUDENTS FOR Oracle Java Certification

SNO	HALL TICKET NO	NAME OF THE STUDENT
1	16E31A1202	ADURLA PAVAN
2	16E31A1203	AKULA PRANATHI
3	16E31A1204	ANDE NAVEEN KUMAR
4	16E31A1206	CHENSUPATHI CHAITANYA
5	16E31A1207	CHIDIMILLA ASHWIDHI
6	16E31A1208	DEVARANENI SANJAY
7	16E31A1211	GOLI ARUN KUMAR
8	16E31A1212	KARING DINESH
9	16E31A1213	KEERTHI SAI KRISHNA
10	16E31A1214	KURUVA VAISHNAVI
11	16E31A1217	NANDIKANTI TEJASWINI
12	16E31A1218	PADALA NAVIKANTH CHARY
13	16E31A1219	PAIPATI SHILPA REDDY
14	16E31A1220	PEDDISSETTY NAGA ANUSHA
15	16E31A1221	PERUMALLA KRANTHI KUMAR
16	16E31A1223	R VAISHNAVI
17	16E31A1224	SAMREEN SULTANA
18	16E31A1225	SRIDHARA GAYATHRI
19	16E31A1227	THADIPARTHI THEJASWINI
20	16E31A1228	VADHADIYA SHONA
21	16E31A1229	VATTIKUTI MAHESH
22	16E31A1230	VITTEDI PAVAN REDDY
23	16E31A1231	YASA ABHINAYA
24	18E31A1201	AFRAH MOHAMMADI
25	18E31A1202	AINDLA ADHISHTEK
26	18E31A1203	AMUDALA SHIRANAN GOLD
27	18E31A1204	DEERAVVOLI SHIRSHIKA
28	18E31A1206	DUDEPUDI RISHINATHI
29	18E31A1207	CHILAKAPATI SANJAY BHARADWAJ
30	18E31A1208	CHIMATA AKHILA
31	18E31A1209	DANDU SRINU
32	18E31A1210	DARA ANUJ
33	18E31A1211	FAREEHA MUZAFFAR
34	18E31A1212	GYAGA MAMATHA
35	18E31A1213	J VAMSHI
36	18E31A1214	KIRAN KUMARI
37	18E31A1216	MAILARAM MAMATHA
38	18E31A1218	MOHAMMED ZAHED HUSSAIN
39	18E31A1219	MOURYA POOJA
40	18E31A1220	P. BISHWATHI
41	18E31A1221	POLKAM PUSHPALATHA

K. Subash
E.P.
4/10/2016
Keshavgi, Hyderabad-500 005

Vyasapuri, Bandlaguda Post: Keshavnagar,

Hyderabad-500 005, TELANGANA INDIA
Tel: 040-64596979, 6978380692. Fax: 040-24455003
E-mail: ejhod.iit@gmail.com,
Website: www.mist.ac.in,

MAHAVEER

INSTITUTE OF SCIENCE & TECHNOLOGY

Approved by AICTE, Affiliated to JNTUH, Hyd.



DEPARTMENT OF INFORMATION TECHNOLOGY

42	18E31A1222	VANAMALA SAI SANTHOSH CHARY
43	18E31A1223	RAGHAVENDAR REDDY B
44	18E31A1226	THIPPAREDDY MAHESHWAR PEDDY
45	18E31A1227	THIRUNAGARI JAYANTHI
46	19E35A1201	GUGULOTH MAHESH
47	19E35A1202	PENDYALA SHARATH CHANDRA
48	19E35A1204	SHAIK MOHAMMED NEYMATH FURQAN MEHER
49	17E31A1224	MOTHE NITHIN REDDY

Dr. J. L. ...
Principal
Mahaveer Institute of Science & Technology
Bandlaguda, Hyderabad - 500 005

K. K. K.
PRINCIPAL
MAHAVEER
INSTITUTE OF SCIENCE & TECHNOLOGY
Bandlaguda, Hyd-500 005

Vyasapuri, Bandlaguda Post:Keshavnagar,

Hyderabad-500 005, TELANGANA INDIA
Tel: 040-64596979,8978380692, Fax: 040-24455003
E-mail: edhod.it@gmail.com,
Website: www.mist.ac.in,

MAHAVEER

INSTITUTE OF SCIENCE & TECHNOLOGY

Approved by AICTE, Affiliated to JNTUH,Hyd.



DEPARTMENT OF INFORMATION TECHNOLOGY

Grade Java Certification QUESTION PAPER

Duration: 120 Minutes

10 X 2 = 20 Marks

Answer the following all questions. Each question carries 2 marks.

1. What Are Group Functions?
2. What is DML?
3. What are Constraints?
4. What is a View?
5. How Are Indexes Created?
6. What Is a Subquery?
7. What Is PL/SQL?
8. What is the difference between TRANSLATE and REPLACE?
9. How do we display rows from the table without duplicates?
10. What is Trigger?

Dr. A. Krishna
HOD, Dept. of Information Technology
Mahaveer Institute of Science & Technology
Vyasapuri, Bandlaguda, Post Keshavnagar
Hyderabad-500005.

K. Srinivas
PRINCIPAL
MAHAVEER
INSTITUTE OF SCIENCE & TECHNOLOGY
Bandlaguda, Hyd-500 005.

Wazirpur, Bandlaguda Post, Keshavnagar,

Hyderabad-500 005, TELANGANA INDIA
Tel: 040-64506079, 8978380692 Fax: 040-24455003
E-mail: o3had.d@gmail.com
Website: www.mist.ac.in

MAHAVEER

INSTITUTE OF SCIENCE & TECHNOLOGY
Approved by AICTE. Affiliated to JNTUH, Hyd.



DEPARTMENT OF INFORMATION TECHNOLOGY

RESULT SHEET FOR Oracle Java Certification REGISTERED STUDENTS

SNO	HALL TICKET NO	NAME OF THE STUDENT	MARKS (20)	RESULT
1	16E31A1202	ADURLA PAVAN	20	PASS
2	16E31A1203	AKULA PRANATHI	19	PASS
3	16E31A1204	ANDE NAVEEN KUMAR	20	PASS
4	16E31A1206	CHENNUPATI CHAITANYA	18	PASS
5	16E31A1207	CHIDIMILLA ASHWIDHI	20	PASS
6	16E31A1208	DEVARANENI SANJAY	20	PASS
7	16E31A1211	GOLI ARUN KUMAR	16	PASS
8	16E31A1212	KARING DINESH	20	PASS
9	16E31A1213	KEERTHI SAI KRISHNA	20	PASS
10	16E31A1214	KURUVA VAISHNAVI	17	PASS
11	16E31A1217	NANDIKANTI TEJASWINI	20	PASS
12	16E31A1218	PADALA NAVIKANTH CHARY	20	PASS
13	16E31A1219	PAPATI SHILPA REDDY	16	PASS
14	16E31A1220	PEDDISSETTY NAGA ANUSHA	20	PASS
15	16E31A1221	PERUMALLA KRANTHI KUMAR	20	PASS
16	16E31A1223	R VAISHNAVI	18	PASS
17	16E31A1224	SAMREEN SULTANA	20	PASS
18	16E31A1225	SRIDHARA GAYATHRI	19	PASS
19	16E31A1227	THADIPARTHI THEJASWINI	20	PASS
20	16E31A1228	VADHADIYA SRINA	18	PASS
21	16E31A1229	VATTIKUTI MAHESH	20	PASS
22	16E31A1230	VITTEDI PAVAN REDDY	20	PASS
23	16E31A1231	YASA ABHINAYA	16	PASS
24	18E31A1201	AFRAN MOHAMMADI	20	PASS
25	18E31A1202	AINDLA ABHISHEK	19	PASS
26	18E31A1203	ASHIDALA SHRAVAN GOUD	20	PASS
27	18E31A1205	BEERAVOLU SHIRSHIKA	18	PASS
28	18E31A1206	BODEPUDI BISHNATH	20	PASS
29	18E31A1207	CHILAKAPATI SANJAY BHARADWAJ	20	PASS
30	18E31A1208	CHIMATA ACHILA	16	PASS
31	18E31A1209	DANDU SRINU	20	PASS
32	18E31A1210	DARA ANUJ	20	PASS
33	18E31A1211	FAREEHA MUZAFFAR	17	PASS
34	18E31A1212	GYADA MAMATHA	20	PASS
35	18E31A1213	J VAMSHI	20	PASS
36	18E31A1214	KIRAN KUMARI	16	PASS
37	18E31A1216	MAILARAM MAMATHA	20	PASS
38	18E31A1218	MOHAMMED ZAHED HUSSAIN	20	PASS
39	18E31A1219	MOURYA POOJA	20	PASS
40	18E31A1220	P BISHWATHI	18	PASS
41	18E31A1221	POLKAM PUSHPALATHA	20	PASS

K. Sankar
18/03/2018
18/03/2018

Vyasaiah, Bandlaguda Post:Keechavalli,

Hyderabad-500 005, TELANGANA INDIA
Tel: 040-64596979,8978380692,Fax: 040-24455003
E-mail: z3hod.it@gmail.com
Website: www.mist.ac.in

MAHAVEER

INSTITUTE OF SCIENCE & TECHNOLOGY

Approved by AICTE, Affiliated to JNTUH,Hyd.



DEPARTMENT OF INFORMATION TECHNOLOGY

42	18E31A1222	VANAMALA SAI SANTHOSH CHARY	20	PASS
43	18E31A1223	RAGHAVENDAR REDDY B	18	PASS
44	18E31A1226	THIPPAREDDY MAHESHWAR REDDY	20	PASS
45	18E31A1227	THIRUNAGARI JAYANTH	20	PASS
46	19E35A1201	GUGULOTH MAHESH	16	PASS
47	19E35A1202	PENDYALA SHARATH CHANDRA	20	PASS
48	19E35A1204	SHAIK MOHAMMED NEYMATH FURQAN MEHDI	20	PASS
49	17E31A1224	MOETHE NITHIN REDDY	16	PASS

No. of students Registered:49

No. of students Passed:49

No. of students failed:NIL

Principal,
Mahaveer Institute of Science & Technology,
Vyasaiah, Bandlaguda Post, Keechavalli,
Hyderabad-500 005.

Kanthy
PRINCIPAL
MAHAVEER
INSTITUTE OF SCIENCE & TECHNOLOGY
Bandlaguda, Hyderabad-500 005

Vysapuri, Bandlaguda Post: Keshavpuram,

Hyderabad-500 005, TELANGANA INDIA
Tel: 040-64596979, 8978380892 Fax: 040-24455063
E-mail: elhad.it@gmail.com
Website: www.mist.ac.in

MAHAVEER

INSTITUTE OF SCIENCE & TECHNOLOGY
Approved by AICTE. Affiliated to JNTUH, Hyd.



DEPARTMENT OF INFORMATION TECHNOLOGY

SUMMARY REPORT OF Oracle Java Certification

Oracle is a database that delivers excellent performance when challenged with demanding tasks.

The ACID test, which is an important tool used to ensure the integrity of data stored, was easily passed by Oracle databases.

This test is important since reliable data storage is the main purpose of a database.

Java is one of the most popular programming languages used to create Web applications and platforms.

It was designed for flexibility, allowing developers to write code that would run on any machine, regardless of architecture or platform.

CORRELATOR

Copy to:

1. Department Notice Board
2. Principal for Information
3. Committee Members (Academic)

MAHAVEER
INSTITUTE OF SCIENCE & TECHNOLOGY
BANDLAGUDA POST, KESHAVPURAM
HYDERABAD-500 005



ESTD : 2001

MAHARAJA INSTITUTE OF SCIENCE & TECHNOLOGY

Approved by AICTE, Affiliated to JNTU, Hyderabad,
Vyasaopet, Bandlaguda, Post: Keshavnagar, Hyderabad-500 063



DEPARTMENT OF INFORMATION TECHNOLOGY

CERTIFICATE

This is to certify that **PENDYALA SHARATH CHANDRA** bearing
Hall Ticket No **19E35A1202** of **B.Tech Second Year** has participated in
Oracle Java Certification training Program From **17-02-2020** to **29-02-2020**
organized by Dept. of **INFORMATION TECHNOLOGY**.

Webtek
ESTD: 2001
P. No. 005-006-007-008-009-010-011-012-013-014-015-016-017-018-019-020-021-022-023-024-025-026-027-028-029-030-031-032-033-034-035-036-037-038-039-040-041-042-043-044-045-046-047-048-049-050

Nanda Gopal Reddy
Dr. Nanda Gopal Reddy
HOD

Puja Bhatia
Puja Bhatia
Director/Webtek Labs. Pvt. Ltd.

K.S.S.N.Reddy
K.S.S.N.Reddy
PRINCIPAL

Vysapuri, Bandlaguda Post:Keshavgirl,
Hyderabad-500 005, Telangana INDIA
Tel: 040-64596979,20020773, Fax: 040-24455003
E-mail: principal.mahaveer@gmail.com
Website: www.mist.ac.in,

MAHAVEER

UNIVERSITY OF SCIENCE & TECHNOLOGY
Approved by AICTE, Affiliated to JNTUH,Hyd



DEPARTMENT OF AERONAUTICAL ENGINEERING

PROPOSAL LETTER

Hyderabad,

12/08/2019.

To,
The principal,
MIST,
Hyderabad.

Sub: Proposal for two weeks workshop on Computer Aided Analysis FLUENT-Reg.

Dear Sir,

We are working as Asst professor in the department of AERONAUTICAL ENGINEERING.

Sir, we are going to conduct three weeks workshop Computer Aided Analysis FLUENT. We require your approval to go head for further proceeding and hope to get an opportunity to serve you the best.

With thanks and Regards

From,

AERO Department

Mist,

Bandlaguda,

K. Srinivas
PRINCIPAL
MAHAVEER
UNIVERSITY OF SCIENCE & TECHNOLOGY
BANDLAGUDA, HYD-500 005.

A. Srinivas



DEPARTMENT OF AERONAUTICAL ENGINEERING

Date: 21.08.2019

CIRCULAR

Technical Training for II B. Tech students are starting from 21-08-2019 onwards. All HODs and Placements coordinators have to manage the trainings and ensure 95% attendance all through the sessions.

All Mentors need to send the compiled feedback report to A Ranga Reddy, HOD at e3hod.aero@gmail.com daily.

Agenda: Computer Aided Analysis FLUENT

Prof RANGA REDDY

HOD

Course Designed By

Dr SR DHINESH KUMAR

N MAHESH

Checked
PRINCIPAL
MAHAVEER
INSTITUTE OF MULTIMEDIA TECHNOLOGY
Bandlaguda, Hyderabad-500 105



SYLLABUS

Course: Computer Aided Analysis FLUENT

1 : Introduction

- What is CFD?
- Applications of CFD & Uses of CFD
- The Mathematics of CFD
- Fundamentals of Fluid Mechanics
- EQUATION OF STATE CFD Methodology
- Introduction to ANSYS Fluent

2: Graphical interface

- Menu Bar & Toolbars
- The Navigation Pane
- Task Pages
- The Console
- Boundary Conditions
- Fluent in Workbench

3: Solid Modeling Fundamentals

- Creating a Fluent Fluid Flow Analysis System in ANSYS Workbench
- Creating the Geometry in ANSYS DesignModeler
- Meshing the Geometry in the ANSYS Meshing Application
- Setting Up the CFD Simulation in ANSYS Fluent
- Displaying Results in ANSYS Fluent and CFD-Post

4: Turbulence Model in Fluent

- Preliminary Analysis
- Geometry Mesh
- Mesh Refinement
- Physics Setup
- Numerical Solution

K. Mahaveer
PRINCIPAL
MAHAVEER
INSTITUTE OF SCIENCE & TECHNOLOGY
Vysapuri, Bandlaguda, Hyderabad-500 005

Vysapuri, Bandlaguda Post-Keshavnagar,
Hyderabad-500 005, Telangana INDIA
Tel: 040-64399779, 20070773, Fax: 040-24455003
E-mail: principalmahaveer@gmail.com
Website: www.mist.ac.in

MAHAVEER

INSTITUTE OF SCIENCE & TECHNOLOGY
Approved by AICTE. Affiliated to JNTUH, Hvd.



Computer Aided Analysis FLUENT Course

STUDENT LIST 2019-20

S. No.	Hall Ticket No	Name	YEAR
1	18E31A2101	ABHISHEK KUMAR	II
2	18E31A2103	CHAVAN SRI VENKATA LAXMI NARSIMHA RAO	II
3	18E31A2104	CHETTE SHRAVAN	II
4	18E31A2105	EJJA SRINIVAS	II
5	18E31A2106	GODISELA TEJA	II
6	18E31A2109	KOLA IMMANUEL	II
7	18E31A2110	KOVURU RAHUL	II
8	18E31A2111	KURUMETI HYMAVATHI	II
9	18E31A2113	MANISH SHARMA	II
10	18E31A2114	MASNA PRATHIBHA BHARATHI	II
11	18E31A2120	NUNNA DEEPAK	II
12	18E31A2121	ONUKURI SYAM SUNDAR SINGH	II
13	18E31A2122	PONNADA SINDHU SRAVANTHI	II
14	18E31A2123	PULJALA PRUTHVI SHANKAR	II
15	18E31A2124	RALLABANDI SATYA SREE RUPA	II
16	18E31A2125	SANGAM NAGALAXMI	II
17	18E31A2126	SANGU VIJAYENDER REDDY	II
18	18E31A2128	SYED SHAHNOON UDDIN ISMAIL	II
19	18E31A2129	TAPATTLA RADHIKA	II

K. K. K.
PRINCIPAL
MAHAVEER
INSTITUTE OF SCIENCE & TECHNOLOGY
Bandlaguda, Hyd-500 005

A. Damodhar
HOD

Vysapuri, Bandlaguda Post:Keshavgiri,
Hyderabad-500 005, Telangana INDIA
Tel: 040-64596979,20020773, Fax: 040-24455003
E-mail: principal.mahaveer@gmail.com,
Website: www.mist.ac.in,

MAHAVEER

Approved by AICTE, Affiliated to JNTUH,Hyd.



20	18E31A2130	U MOUNIKA	II
21	18E31A2131	YERRA JOSHI	II
22	19E35A2102	JANNU MANOJ KUMAR	II
23	19E35A2103	MUTHYALA GIRIDHAR	II
24	19E35A2104	PITTA KISHORE	II

A. Doodra
HOD

W. S. S. S.
PRINCIPAL
MAHAVEER
INSTITUTE OF MULTIPLE DISCIPLINES
HYDRABAD, TELANGANA, INDIA-500005



Technical Training Exam on fluent
(A.Y-2019-20)

2x10=20 Marks

Answer All the Questions Computer Aided Analysis FLUENT

1. Use k omega model for flow and complete the analysis over aerofoil NACA 4415

Name	Thickness (%)	Maximum lift coefficient	Maximum lift-to-drag (LD)	Stall angle (°)
NACA 4415	15.0	1.64	55.4	14.0

2. Analyze the flow inside the pipe using Structured mesh and unStructured mesh.



Computer Aided Analysis FLUENT course

Training student marks list 2019-20

S. No.	Hall Ticket No	Name	MARKS	PASS/FAIL
1	18E31A2101	ABHISHEK KUMAR	18	PASS
2	18E31A2103	CHAVAN SRI VENKATA LAXMI NARSIMHA RAO	16	PASS
3	18E31A2104	CHEPPE SHRAVAN	19	PASS
4	18E31A2105	EJJA SRINIVAS	16	PASS
5	18E31A2106	GODISELA TEJA	15	PASS
6	18E31A2109	KOLA IMMANUEL	17	PASS
7	18E31A2110	KOVURU RAHUL	18	PASS
8	18E31A2111	KURUMETI HYMAVATHI	19	PASS
9	18E31A2113	MANISH SHARMA	15	PASS
10	18E31A2114	MASNA PRATHIBHA BHARATHI	15	PASS
11	18E31A2120	NUNNA DEEPAK	15	PASS
12	18E31A2121	ONUKURI SYAM SUNDAR SINGH	15	PASS
13	18E31A2122	PONNADA SINDHU SRAVANTHI	16	PASS
14	18E31A2123	PULJALA PRUTHVI SHANKAR	17	PASS
15	18E31A2124	RALLABANDI SATYA SREE RUPA	18	PASS
16	18E31A2125	SANGAM NAGALAXMI	18	PASS
17	18E31A2126	SANGU VIJAYENDER REDDY	18	PASS
18	18E31A2128	SYED SHAHNOON UDDIN	17	PASS

Handwritten signature
MAHAVEER
INSTITUTE OF TECHNOLOGY & RESEARCH
BANDLAGUDA, HYD-500005

Handwritten signature
HOD

Vysapuri, Bandlaguda Post:Keshavgiri,
Hyderabad-500 005, Telangana INDIA
Tel: 040-64596979,20020773, Fax: 040-24455003
E-mail: principal.mahaveer@gmail.com,
Website: www.mist.ac.in,

MAHAVEER

INSTITUTE OF DISTANCE & TECHNOLOGY
Approved by AICTE, Affiliated to JNTUH Hyd.



		ISMAIL		
19	18E31A2129	TAPATTLA RADHIKA	17	PASS
20	18E31A2130	U MOUNIKA	17	PASS
21	18E31A2131	YERRA JOSHI	15	PASS
22	19E35A2102	JANNU MANOJ KUMAR	17	PASS
23	19E35A2103	MUTHYALA GIRIDHAR	15	PASS
24	19E35A2104	PITTA KISHORE	16	PASS

D. Ramesh
HOD

K. Sankar
PRINCIPAL
MAHAVEER
INSTITUTE OF DISTANCE & TECHNOLOGY
Bandlaguda, Hyderabad-500 005.

MAHAVEER INSTITUTE OF SCIENCE AND TECHNOLOGY
AERONAUTICAL ENGINEERING
COURSE ATTENDANCE LIST

S NO	HT NO	NAME	21	22	23	24	27	28	29	30	31
1	18E31A2101	ABHISHEK KUMAR	P	P	P	P	P	P	P	P	P
2	18E31A2101	CHAVAN SRI VEKKATT LAXMI WARSIMHA RAO	P	P	P	P	P	P	P	P	P
3	18E31A2101	CHEITE SHRIVAN	P	P	P	P	P	P	P	P	P
4	18E31A2105	EJJA SHRINIVAS	P	P	P	P	P	P	P	P	P
5	18E31A2106	GODISELA TEJA	P	P	P	P	P	P	P	P	P
6	18E31A2109	KOLA IMMANUEL	P	P	P	P	P	P	P	P	P
7	18E31A2110	KOVURU RAHUL	P	P	P	P	P	P	P	P	P
8	18E31A2111	KURUMETI HIMAVATHI	P	P	P	P	P	P	P	P	P
9	18E31A2113	MANISH SHARMA	P	P	P	P	P	P	P	P	P
10	18E31A2114	MASNA PRATHIBHA BHARATHI	P	P	P	P	P	P	P	P	P
11	18E31A2120	NUJNA DEEPAK	P	P	P	P	P	P	P	P	P
12	18E31A2121	OMKURI SVAM SUNDAR SINGH	P	P	P	P	P	P	P	P	P
13	18E31A2122	PONNADA SINDHU SRAVANTHI	P	P	P	P	P	P	P	P	P
14	18E31A2123	PULLALA PRUTHVI SHANKAR	P	P	P	P	P	P	P	P	P
15	18E31A2124	PALLABANDY SATYA SREE RUPA	P	P	P	P	P	P	P	P	P
16	18E31A2125	SANGAM NAGALAKSHI	P	P	P	P	P	P	P	P	P
17	18E31A2126	SANGU VILAVENDER VEJIDY	P	P	P	P	P	P	P	P	P
18	18E31A2128	SYED SHAHNOON UDDIN ISMAIL	P	P	P	P	P	P	P	P	P
19	18E31A2129	TAPATTLA RADHIKA	P	P	P	P	P	P	P	P	P
20	18E31A2190	U MDURINA	P	P	P	P	P	P	P	P	P
21	18E31A2131	YERRA JOSHI	P	P	P	P	P	P	P	P	P
22	19E35A2102	JAYINU MANOJ KUMAR	P	P	P	P	P	P	P	P	P
23	19E35A2103	MUTHYALA GIRIDHAR	P	P	P	P	P	P	P	P	P
24	19E35A2104	PITTA KRISHORE	P	P	P	P	P	P	P	P	P

Handwritten signature

Handwritten signature

HOD

MAHAVEER INSTITUTE OF SCIENCE AND TECHNOLOGY
AERONAUTICAL ENGINEERING
COURSE ATTENDANCE LIST

Vysapuri, Bandlaguda Post:Keshavgiri,
Hyderabad-500 005, Telangana INDIA
Tel: 040-64596979,20020773, Fax: 040-24455003
E-mail: principal.mahaveer@gmail.com,
Website: www.mist.ac.in,

MAHAVEER

INSTITUTE OF SCIENCE & TECHNOLOGY
Approved by AICTE, Affiliated to JNTUH,Hyd.



Course: Computer Aided Analysis FLUENT

Summary report

ANSYS Fluent is a powerful computational fluid dynamics (CFD) software for optimizing product's performance. Its broad physical modeling capabilities help model flow, turbulence, and heat transfer. With ANSYS Fluent you have access to several fluid flow physics model, which help analyze your product with precision

Ansyz FLUENT software contains the broad physical modeling capabilities needed to model flow, turbulence, heat transfer, and reactions for industrial applications ranging from air flow over an aircraft wing to combustion in a furnace, from bubble columns to oil platforms, from blood flow to semiconductor manufacturing

A. D. D. D.
HOD

K. S. S.
PRINCIPAL
MAHAVEER
INSTITUTE OF SCIENCE & TECHNOLOGY
Bandlaguda, Hyderabad-500005

Vysapuri, Bandlaguda Post:Keshavgi,
Hyderabad-509 005, Telangana INDIA
Tel: 040-64596979,20026773, Fax: 040-24455003
E-mail: principal.mahaveer@gmail.com
Website: www.mist.ac.in

MAHAVEER



Approved by AICTE. Affiliated to JNTUH,Hyd.

CERTIFICATE OF COURSE COMPLETION

This certificate is presented to CHETTE SHRAVAN of MIST, who has successfully completed technical training course on “Computer Aided Analysis FLUENT” held from 21-08-2019 to 05-09-2019 and found the student performance to be excellent.



ESTD : 2001

A. Ranga Reddy

A RANGA REDDY

HOD (AERO)

W. S. Srinivas
PRINCIPAL
MAHAVEER
INSTITUTE OF SCIENCE & TECHNOLOGY
Bandlaguda, Hyderabad-509005

Vysapuri, Bandlaguda Post:Keshavgiri,

Hyderabad-500 005, TELANGANA INDIA
Tel: 040-64596979,8978380692,Fax: 040-24455003
E-mail: e3hod.it@gmail.com,
Website: www.mist.ac.in,

MAHAVEER
INSTITUTE OF SCIENCE & TECHNOLOGY
Approved by AICTE, Affiliated to JNTUH,Hyd.



DEPARTMENT OF HUMANITIES AND SCIENCES

Date: 20-08-19

To,
The principal,
MIST ,
Hyderabad.

Sub: Proposal for Add-on-course-Reg
Dear sir,

We are going to conduct Add-On course on softskills. we require your approval to go head for further proceeding and hope to get an opportunity to serve you the best.

With thanks and Regards

PRINCIPAL
MAHAVEER
INSTITUTE OF SCIENCE & TECHNOLOGY
Bandlaguda, Hyd-500 005.

HOD
Department of Humanities & Sciences
Mahaveer Institute of Science & Technology,
HYDERABAD

Vysapuri, Bandlaguda Post:Keshavgi,

Hyderabad-500 005, TELANGANA INDIA
Tel: 040-64596979,8978380692,Fax: 040-24455003
E-mail: e3hod.it@gmail.com,
Website: www.mist.ac.in,

MAHAVEER
INSTITUTE OF SCIENCE & TECHNOLOGY
Approved by AICTE, Affiliated to JNTUH,Hyd.



DEPARTMENT OF HUMANITIES AND SCIENCES

Date: 20-08-19

CIRCULAR

CRASH COURSE FOR I B.Tech students are starting from 20-08-19 onwards. All HODs and placements coordinators have to manage the trainings and ensure 95% attendance all through the sessions.

All mentors need to send the compiled feedback report to HOD at e3hod@gmail.com daily. Mentors are advised to take care of PNR (Students not participating in training).

Agenda:SOFTSKILLS

Design and Development of Curriculum for Add on Course

Name of Faculty: 1.VENITHA
2.M.JAISHREE

PRINCIPAL
MAHAVEER
INSTITUTE OF SCIENCE & TECHNOLOGY
Bandlaguda, Hyd-500 005.

HOD
Department of Humanities & Sciences
Mahaveer Institute of Science & Technology
HYDERABAD

Vysapuri, Bandlaguda Post:Keshavgi,

Hyderabad-500 005, TELANGANA INDIA

Tel: 040-64596979,8978380692,Fax: 040-24455003

E-mail: e3hod.it@gmail.com,

Website: www.mist.ac.in,

MAHAVEER
INSTITUTE OF SCIENCE & TECHNOLOGY

Approved by AICTE, Affiliated to JNTUH,Hyd.

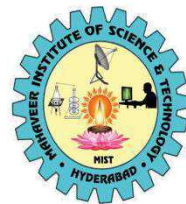

DEPARTMENT OF HUMANITIES AND SCIENCES

SYLLABUS FOR SOFTSKILLS

SNO	TOPIC COVERED	DURATION
1	PRESENTATION SKILL	3
2	prepare A presentation	3
3	use presentation aids effectively	3
4	WRITING SKILLS USEFUL AT WORK PLACE	3
5	develop an ability to apply technical information in documentation	3
6	develop correspondent skills	3
7	POSITIVE ATTITUDE	3
8	Examine the impact of positive attitude	3
	Steps needed for improving attitude and behavior	3
9	TEAM WORK	3
10	learn to be a team player	3
11	know the importance of team work	3

PRINCIPAL
MAHAVEER
INSTITUTE OF SCIENCE & TECHNOLOGY
Bandlaguda, Hyd-500 005.

HOD
Department of Humanities & Sciences
Mahaveer Institute of Science & Technology
HYDERABAD

Vysapuri, Bandlaguda Post:Keshavgiri,

Hyderabad-500 005, TELANGANA INDIA

Tel: 040-64596979,8978380692,Fax: 040-24455003

E-mail: e3hod.it@gmail.com,

Website: www.mist.ac.in,

MAHAVEER
INSTITUTE OF SCIENCE & TECHNOLOGY

Approved by AICTE, Affiliated to JNTUH,Hyd.



DEPARTMENT OF HUMANITIES AND SCIENCES

LIST OF REGISTERED STUDENTENS FOR SOFTSKILLS

SNO	HOLL TICKET NO	NAME OF THE STUDENT
1	19E31A0401	ALEENA FAHEEM
2	19E31A0414	CHEVULA AKHIL GOUD
3	19E31A0439	MD SABA TABASSUM
4	19E31A0441	MUDAVATH SRINIVAS
5	19E31A0445	P JAYA KRISHNA REDDY
6	19E31A0202	AKULA RAKESH
7	19E31A0211	GUNUGANTI SPOORTHI
8	19E31A0219	NALLA RAHUL
9	19E31A0220	T DEEPTHI
10	19E31A1203	B KALYAN
11	19E31A1208	GOPU AASHISH
12	19E31A1218	NALLANI SADVINI
13	19E31A1228	VADLA VYSHNAVI
14	19E31A0502	A JHANA VI
15	19E31A0509	C PRAKASH
16	19E31A0520	MADDENI UDAY
17	19E31A0526	N SANDEEP
18	19E31A0560	BADA ANUSH
19	19E31A0576	N MOUNIKA
20	19E31A2104	GATTU MANISH
21	19E31A2113	LANKA TEJA
22	19E31A2126	NALLAM TANUSREE
23	19E31A0302	BANOTH ANIL KUMAR
24	19E31A0303	BHUKYA VAMSHI
25	19E31A0309	SINDE UJWAL

Keshav

PRINCIPAL
MAHAVEER
INSTITUTE OF SCIENCE & TECHNOLOGY
Bandlaguda, Hyd-500 005.

M Ratibha

HOD
Department of Humanities & Sciences
Mahaveer Institute of Science & Technology,
HYDERABAD

Vysapuri, Bandlaguda Post:Keshavgiri,

Hyderabad-500 005, TELANGANA INDIA

Tel: 040-64596979,8978380692,Fax: 040-24455003

E-mail: e3hod.it@gmail.com,

Website: www.mist.ac.in,

MAHAVEER
INSTITUTE OF SCIENCE & TECHNOLOGY
Approved by AICTE, Affiliated to JNTUH,Hyd.



DEPARTMENT OF HUMANITIES AND SCIENCES

SOFTSKILLS QUESTION PAPER

DURATION:120 MINUTES

MAX.MARKS 50

ANSWER ANY 5 QUESTIONS.

5*10=50

- 1.what are the presentation aids?
- 2.what are the writing skills useful to develop an ability to apply technical information in documentation?
- 3.How to Examine the impact of positive attitude?
4. what are Steps needed for improving attitude and behavior?
- 5.How to know the importance of team work?
- 6.How to learn to be a team player?

PRINCIPAL
MAHAVEER
INSTITUTE OF SCIENCE & TECHNOLOGY
Bandlaguda, Hyd-500 005.

Vysapuri, Bandlaguda Post:Keshavgi,

Hyderabad-500 005, TELANGANA INDIA

Tel: 040-64596979,8978380692,Fax: 040-24455003

E-mail: e3hod.it@gmail.com,

Website: www.mist.ac.in,

MAHAVEER
INSTITUTE OF SCIENCE & TECHNOLOGY

Approved by AICTE, Affiliated to JNTUH,Hyd.



DEPARTMENT OF HUMANITIES AND SCIENCES

RESULT SHEET FOR SOFTSKILLS REGISTERED STUDENTS

SNO	HOLL TICKET NO	NAME OF THE STUDENT	MARKS(20)	RESULT
1	19E31A0401	ALEENA FAHEEM	20	PASS
2	19E31A0414	CHEVULA AKHIL GOUD	19	PASS
3	19E31A0439	MD SABA TABASSUM	20	PASS
4	19E31A0441	MUDAVATH SRINIVAS	18	PASS
5	19E31A0445	P JAYA KRISHNA REDDY	20	PASS
6	19E31A0202	AKULA RAKESH	19	PASS
7	19E31A0211	GUNUGANTI SPOORTHI	18	PASS
8	19E31A0219	NALLA RAHUL	20	PASS
9	19E31A0220	T DEEPTHI	18	PASS
10	19E31A1203	B KALYAN	18	PASS
11	19E31A1208	GOPU AASHISH	19	PASS
12	19E31A1218	NALLANI SADVINI	19	PASS
13	19E31A1228	VADLA VYSHNAVI	20	PASS
14	19E31A0502	A JHANAVI	20	PASS
15	19E31A0509	C PRAKASH	20	PASS
16	19E31A0520	MADDENI UDAY	19	PASS
17	19E31A0526	N SANDEEP	19	PASS
18	19E31A0560	BADA ANUSH	18	PASS
19	19E31A0576	N MOUNIKA	18	PASS
20	19E31A2104	GATTU MANISH	20	PASS
21	19E31A2113	LANKA TEJA	18	PASS
22	19E31A2126	NALLAM TANUSREE	17	PASS
23	19E31A0302	BANOTH ANIL KUMAR	16	PASS
24	19E31A0303	BHUKYA VAMSHI	20	PASS
25	19E31A0309	SINDE UJWAL	19	PASS

No.of students registred:20

No.of students passed :20

No.of students failed :Nil

PRINCIPAL
MAHAVEER
INSTITUTE OF SCIENCE & TECHNOLOGY
Bandlaguda, Hyd-500 005.

Vysapuri, Bandlaguda Post:Keshavgi,

Hyderabad-500 005, TELANGANA INDIA

Tel: 040-64596979,8978380692,Fax: 040-24455003

E-mail: e3hod.it@gmail.com,

Website: www.mist.ac.in,

MAHAVEER
INSTITUTE OF SCIENCE & TECHNOLOGY

Approved by AICTE, Affiliated to JNTUH,Hyd.



DEPARTMENT OF HUMANITIES AND SCIENCES

SUMMARY REPORT OF SOFTSKILLS

Soft skills, also known as common skills or core skills, are skills which are desirable in all professions. These include critical thinking, problem solving, public speaking, professional writing, teamwork, digital literacy, leadership, professional attitude, work ethic, career management and intercultural fluency. This is in contrast to hard skills, which are specific to individual professions. The word "skill" highlights the practical function. The term alone has a broad meaning, and describes a particular ability to complete tasks ranging from easier ones like "learning how to kick a ball" to harder ones like "learning how to be creative". In this specific instance, the word "skill" has to be interpreted as the ability to master hardly controlled actions.

Cordinator

COPY TO:

1. Department notice board.
2. Principal for information
3. committee members (academic)

PRINCIPAL
MAHAVEER
INSTITUTE OF SCIENCE & TECHNOLOGY
Bandlaguda, Hyd-500 005.

MAHAVEER INSTITUTE OF SCIENCE & TECHNOLOGY
DEPARTMENT OF HUMANITIES AND SCIENCE
SOFT SKILLS ATTENDANCE SHEET

S.NO	R.T NO	NAME OF THE STUDENT	19	21	22	23	24	25	26	27	28	29	30	31	1	2	3	4	5	6	7	8	9	10	11	12	13	14	15	16	17	18	19	20		
1	19E31A0401	ALEENA FAHEEM	P	P	P	P	P	P	P	P	P	P	P	P	P	P	P	P	P	P	P	P	P	P	P	P	P	P	P	P	P	P	P	P	P	
2	19E31A0414	CHEVULA AKHIL DOUD	P	P	P	P	P	P	P	P	P	P	P	P	P	P	P	P	P	P	P	P	P	P	P	P	P	P	P	P	P	P	P	P	P	P
3	19E31A0439	MD SABA TABASSUM	P	P	P	P	P	P	P	P	P	P	P	P	P	P	P	P	P	P	P	P	P	P	P	P	P	P	P	P	P	P	P	P	P	P
4	19E31A0443	MUDAVATH SRINIVAS	P	P	P	P	P	P	P	P	P	P	P	P	P	P	P	P	P	P	P	P	P	P	P	P	P	P	P	P	P	P	P	P	P	P
5	19E31A0445	P JAYA KRISHNA REDDY	P	P	P	P	P	P	P	P	P	P	P	P	P	P	P	P	P	P	P	P	P	P	P	P	P	P	P	P	P	P	P	P	P	P
6	19E31A0202	AKULA RAKESH	P	P	P	P	P	P	P	P	P	P	P	P	P	P	P	P	P	P	P	P	P	P	P	P	P	P	P	P	P	P	P	P	P	P
7	19E31A0211	GUNUGANTI SPOORITHI	P	P	P	P	P	P	P	P	P	P	P	P	P	P	P	P	P	P	P	P	P	P	P	P	P	P	P	P	P	P	P	P	P	P
8	19E31A0219	NALLA RAHUL	P	P	P	P	P	P	P	P	P	P	P	P	P	P	P	P	P	P	P	P	P	P	P	P	P	P	P	P	P	P	P	P	P	P
9	19E31A0220	T DEEPTHI	P	P	P	P	P	P	P	P	P	P	P	P	P	P	P	P	P	P	P	P	P	P	P	P	P	P	P	P	P	P	P	P	P	P
10	19E31A1203	B KALYAN	P	P	P	P	P	P	P	P	P	P	P	P	P	P	P	P	P	P	P	P	P	P	P	P	P	P	P	P	P	P	P	P	P	P
11	19E31A1208	GOPU AASHISH	P	P	P	P	P	P	P	P	P	P	P	P	P	P	P	P	P	P	P	P	P	P	P	P	P	P	P	P	P	P	P	P	P	P
12	19E31A1218	NALLANI SADVINI	P	P	P	P	P	P	P	P	P	P	P	P	P	P	P	P	P	P	P	P	P	P	P	P	P	P	P	P	P	P	P	P	P	P
13	19E31A1228	VADLA VYSHNAVI	P	P	P	P	P	P	P	P	P	P	P	P	P	P	P	P	P	P	P	P	P	P	P	P	P	P	P	P	P	P	P	P	P	P
14	19E31A0502	A BHANAVI	P	P	P	P	P	P	P	P	P	P	P	P	P	P	P	P	P	P	P	P	P	P	P	P	P	P	P	P	P	P	P	P	P	P
15	19E31A0509	C PRAKASH	P	P	P	P	P	P	P	P	P	P	P	P	P	P	P	P	P	P	P	P	P	P	P	P	P	P	P	P	P	P	P	P	P	P
16	19E31A0520	MADDENI LIDAY	P	P	P	P	P	P	P	P	P	P	P	P	P	P	P	P	P	P	P	P	P	P	P	P	P	P	P	P	P	P	P	P	P	P
17	19E31A0526	N SANDEEP	P	P	P	P	P	P	P	P	P	P	P	P	P	P	P	P	P	P	P	P	P	P	P	P	P	P	P	P	P	P	P	P	P	P
18	19E31A0569	GADA ANUSH	P	P	P	P	P	P	P	P	P	P	P	P	P	P	P	P	P	P	P	P	P	P	P	P	P	P	P	P	P	P	P	P	P	P
19	19E31A0576	N MOONIKA	P	P	P	P	P	P	P	P	P	P	P	P	P	P	P	P	P	P	P	P	P	P	P	P	P	P	P	P	P	P	P	P	P	P
20	19E31A2104	GATTU MANISH	P	P	P	P	P	P	P	P	P	P	P	P	P	P	P	P	P	P	P	P	P	P	P	P	P	P	P	P	P	P	P	P	P	P
21	19E31A2115	LANKA TEJA	P	P	P	P	P	P	P	P	P	P	P	P	P	P	P	P	P	P	P	P	P	P	P	P	P	P	P	P	P	P	P	P	P	P
22	19E31A2126	NALLAM TANUSREE	P	P	P	P	P	P	P	P	P	P	P	P	P	P	P	P	P	P	P	P	P	P	P	P	P	P	P	P	P	P	P	P	P	P
23	19E31A0302	BANOTH ANIL KUMAR	P	P	P	P	P	P	P	P	P	P	P	P	P	P	P	P	P	P	P	P	P	P	P	P	P	P	P	P	P	P	P	P	P	P
24	19E31A0305	BHUKYA YAMSHI	P	P	P	P	P	P	P	P	P	P	P	P	P	P	P	P	P	P	P	P	P	P	P	P	P	P	P	P	P	P	P	P	P	P
25	19E31A0309	SINDE UJWAL	P	P	P	P	P	P	P	P	P	P	P	P	P	P	P	P	P	P	P	P	P	P	P	P	P	P	P	P	P	P	P	P	P	P

M Ratibha

H/O
 Department of Humanities & Science
 Mahaveer Institute of Science & Technology
 HYDERABAD



**MAHAVEER INSTITUTE OF
SCIENCE AND TECHNOLOGY**
APPROVED BY AICTE AFFILIATED TO JNTUH - HYD.

DEPARTMENT OF
HUMANITIES AND SCIENCES

Certificate

This is to certify that Mr/Ms B Kalyan
bearing Hall Ticket No 19E31A1203 of B.Tech First Year
has participated In Certificate course on
SOFT SKILLS

From 20-08-19 to 12-09-19

Organized by Dept. of Humanities and Sciences

M. Ratilha
HOD
Department of Humanities and Sciences
Mahaveer Institute of Science & Technology
HYDRABAD

K. Hanu
PRINCIPAL
MAHAVEER
INSTITUTE OF SCIENCE & TECHNOLOGY
HYDRABAD, HYD-500 040

Vysapuri, Bandlaguda Post:Keshavgiri,
Hyderabad-500 005, Telangana INDIA
Tel: 040-64596979,20020773,,Fax: 040-24455003
E-mail: principal.mahaveer@gmail.com,
Website: www.mist.ac.in,

MAHAVEER

INSTITUTE OF SCIENCE & TECHNOLOGY
Approved by AICTE, Affiliated to JNTUH,Hyd.



PROPOSAL LETTER

Hyderabad,

24/07/2020.

To,
The principal,
MIST,
Hyderabad.

Sub: Proposal for two weeks workshop on AUTO CAD-Reg,

Dear Sir,

We are working as asst professor in the department of CIVIL ENGINEERING. Sir, we are going to conduct two weeks workshop on AUTO CAD. We require your approval to go head for further proceeding and hope to get an opportunity to serve you the best .

With thanks and Regards

PRINCIPAL
MAHAVEER
INSTITUTE OF SCIENCE & TECHNOLOGY
Bandlaguda, Hyd-500 005.



From,
Civil Department
Mist,
Bandlaguda,
Hyderabad.



Date: 28.07.2020

CIRCULAR

Technical Training for II B. Tech students are starting from 5th Aug, 2020 onwards. All HODs and Placements coordinators have to manage the trainings and ensure 95% attendance all through the sessions.

All Mentors need to send the compiled feedback report to CH Swethamber, HOD at c3hod.civil@gmail.com daily.

Agenda: I. Introduction to AUTOCAD.

Designed by: G ARUNA



Ch. Swethamber
HOD

PRINCIPAL
MAHAVEER
INSTITUTE OF ENGINEERING & TECHNOLOGY
BANDLAGUDA, HYDERABAD



Auto CAD SYLLABUS

1: Getting Started with AutoCAD

- Opening and Creating Drawings
- Exploring the AutoCAD interface
- Zooming and Panning

2: Basic Drawing & Editing Commands

- Using the Mouse, Keyboard, and Enter Key to work quickly and efficiently in AutoCAD
- Lines
- Circles
- Rectangles

3: Projects - Creating a Simple Drawing

- Creating Simple Drawings
- Using Object Snap Tracking to extrapolate a projected top view
- Using Modify tools to arrange an office layout

4: Drawing Precision in AutoCAD

- Polar and Ortho Tracking
- Entering Coordinates and Angles
- Object Snaps and Tracking

5: Making Changes in Your Drawing

- Move
- Copy
- Rotate
- Mirror
- Scale
- Using the reference option with the Scale Tool

7: Organizing Your Drawing with Layers

- Layer States
- Properties by Layer
- Layer Tools

8: Advanced Object Types

Principal Mahaveer

PRINCIPAL
MAHAVEER

INSTITUTE OF SCIENCE & TECHNOLOGY

Hyderabad



- Polylines
- Arcs
- Polygons
- Ellipses

9: Advanced Editing Commands

- Trim and Extend
- Fillet and Chamfer
- Polyline Edit and Spline
- Offset and Explode
- Join

10: Inserting Blocks

- The Insert Block Command
- Inserting Blocks with Tool Palettes
- Dynamic Blocs
- Migrating Blocks and other Elements between Drawings with Design Center

11: Text

- The Multiline Text Tool
- The Single Line Text Tool
- Editing Text
- Text in Model Space vs. Paper Space
- The Multileader Tool

12: Hatching

- The Hatch Command
- The Hatch Editor Ribbon Tab
- Saving and Applying Hatches with Tool Palettes

13: Adding Dimensions

- Using Dimensioning Tools
- Dimensioning in a Layout Tab vs. the Model Tab
- Using Dimension Styles
- Editing Dimensions

14. Projects - Annotating Your Drawing

- Dimensioning a Mechanical Drawing

Praveen Kumar

PRINCIPAL
MAHAVEER
INSTITUTE OF ENGINEERING & TECHNOLOGY

Department of Mechanical Engineering



Vysapuri, Bandlaguda Post:Keshavgiri,
Hyderabad-500 005, Telangana INDIA
Tel: 040-64596979,20020773..Fax: 040-24455003
E-mail: principal.mahaveer@gmail.com,
Website: www.mist.ac.in,

MAHAVEER
INSTITUTE OF SCIENCE & TECHNOLOGY
Approved by AICTE, Affiliated to JNTUH,Hyd.



Department of Civil Engineering
Auto CAD Technical Training student attendance list 2020-21

S.No	Hall Ticket No	Name of the Candidate	Year
1	19E31A0101	AVARI DEEPA	II
2	19E31A0102	B LALITH RAJ	II
3	19E31A0103	BODA RAJESH	II
4	19E31A0104	D SAKETHI	II
5	19E31A0105	GANGADHARI ARAVIND	II
6	19E31A0106	GANTA SHRAVAN KUMAR	II
7	19E31A0107	HAFAZUDDIN MOHAMMED ABDULLAH	II
8	19E31A0108	HANUMANTHU ABHISHEK	II
9	19E31A0109	JARSINGI CHANDRAMOULI	II
10	19E31A0110	JERIPOTHULA HARSHAVARDHAN MOURYA	II
11	19E31A0111	JUVERIA MAHVEEN	II
12	19E31A0112	KALAI VINAY GOUD	II
13	19E31A0113	KATROTHI SRINATHI	II
14	19E31A0114	KUMMARI YASHIWANTHI	II
15	19E31A0115	KURASAM ANU	II

PRINCIPAL
MAHAVEER
INSTITUTE OF SCIENCE & TECHNOLOGY
Bandlaguda, Hyd-500 005



16	19E31A0116	LAKAVATH GANESH	II
17	19E31A0117	MARSAKATLA KEERTHI	II
18	19E31A0118	MOHD FAIZ UDDIN	II
19	19E31A0119	MOHD MISBAHUDDIN	II
20	19E31A0120	N SHIVA SHANKER	II
21	19E31A0121	NENAVATHI NIKHIL	II
22	19E31A0122	PAVULOORI MAHESH	II
23	19E31A0123	PERUMALLA RACHANA	II
24	19E31A0124	RAJAPURAM CHAITANYA KRISHINA REDDY	II
25	19E31A0126	VANKDOTI SRIKANTHI	II
26	19E31A0127	WAJAHAT MOHD KHAN	II
27	19E31A0128	SHAIK ANAS HASHIM	II
28	18E31A0111	GURRAPUSALA VINITHI	II
29	18E31A0115	MOHMMAD YAKUB NADEEM	II
30	18E31A0123	R BALRAJ	II
31	18E31A0125	RAYKODE NIKHIL	II
32	18E31A0127	R BHARATHI	II
33	17E31A0115	G ROHITH VARMA	II
34	20E35A0101	KANJARLA AJAY	II
35	20E35A0103	RANAM ADHINAYA	II
36	20E35A0104	RASALA SANDHYA	II

PRINCIPAL
MAHAVEER
 INSTITUTE OF SCIENCE & TECHNOLOGY
 Mahalingapuram, Hyderabad - 500 005



MAHATMA INSTITUTE OF SCIENCE & TECHNOLOGY, HYDERABAD
FINAL ENGINEERING STUDENTS ATTENDANCE
REGISTRATION SEM 2020-2021 (U.T.I) Date: 25.8.2020 to 29.8.2021

S.No	Roll Folio No	Name of the Candidate
1	19131A0001	ANABETHINA
2	19131A0002	BILAL HIRAF
3	19131A0003	BOJJA BHARATH
4	19131A0004	DANAKHIL
5	19131A0005	DANSHAMBARAVEND
6	19131A0006	DANESH SUREYAN KUMAR
7	19131A0007	HARSHITHAN MOHAMMED ABDELHAMID
8	19131A0008	HANSHANU MOHAMMED
9	19131A0009	HARSHITHAN MOHAMMED
10	19131A0010	HARSHITHAN MOHAMMED
11	19131A0011	HARSHITHAN MOHAMMED
12	19131A0012	HARSHITHAN MOHAMMED
13	19131A0013	HARSHITHAN MOHAMMED
14	19131A0014	HARSHITHAN MOHAMMED
15	19131A0015	HARSHITHAN MOHAMMED
16	19131A0016	HARSHITHAN MOHAMMED
17	19131A0017	HARSHITHAN MOHAMMED
18	19131A0018	HARSHITHAN MOHAMMED
19	19131A0019	HARSHITHAN MOHAMMED
20	19131A0020	HARSHITHAN MOHAMMED
21	19131A0021	HARSHITHAN MOHAMMED
22	19131A0022	HARSHITHAN MOHAMMED
23	19131A0023	HARSHITHAN MOHAMMED
24	19131A0024	HARSHITHAN MOHAMMED
25	19131A0025	HARSHITHAN MOHAMMED
26	19131A0026	HARSHITHAN MOHAMMED
27	19131A0027	HARSHITHAN MOHAMMED
28	19131A0028	HARSHITHAN MOHAMMED
29	19131A0029	HARSHITHAN MOHAMMED
30	19131A0030	HARSHITHAN MOHAMMED
31	19131A0031	HARSHITHAN MOHAMMED
32	19131A0032	HARSHITHAN MOHAMMED
33	19131A0033	HARSHITHAN MOHAMMED
34	19131A0034	HARSHITHAN MOHAMMED
35	19131A0035	HARSHITHAN MOHAMMED
36	19131A0036	HARSHITHAN MOHAMMED
37	19131A0037	HARSHITHAN MOHAMMED
38	19131A0038	HARSHITHAN MOHAMMED
39	19131A0039	HARSHITHAN MOHAMMED
40	19131A0040	HARSHITHAN MOHAMMED

(Handwritten Signature)



PRINCIPAL
M. HAYVEER
 INSTITUTE OF SCIENCE & TECHNOLOGY
 Bandlaguda, Hyderabad-500 095.



Technical Training Exam on Auto CAD Software (A.Y-2020-21)

2x10=20 Marks

Answer All the Questions

1. Draw the given 2D model by using AutoCad

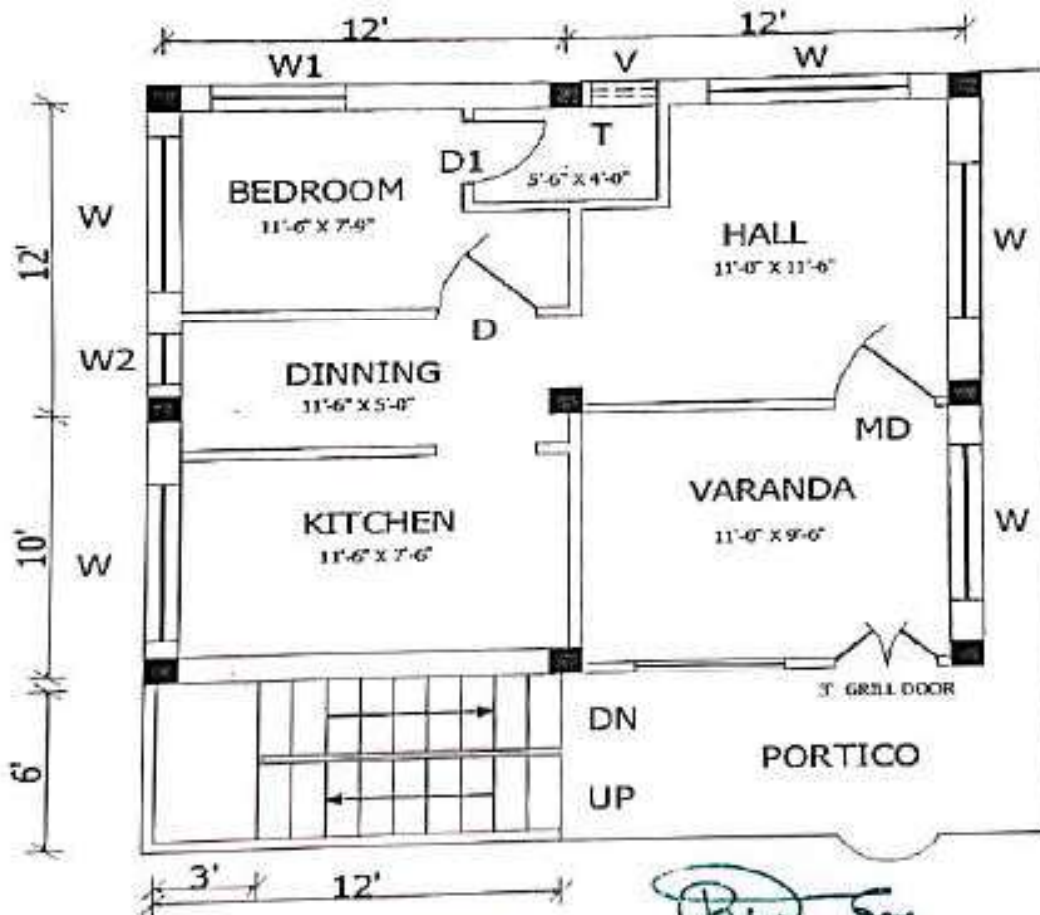

Principals Signature

PRINCIPAL
MAHAVEER

INSTITUTE OF SCIENCE & TECHNOLOGY
bandlaguda, Hyderabad-500005

2. (a) Draw the following using any CAD software and add dimensioning.
 (b) List the commands in sequence and also write the procedure
 (c) Add title box containing Student PIN, name and college name

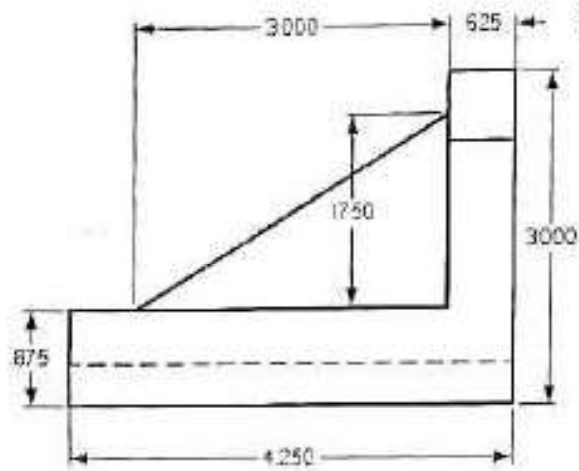
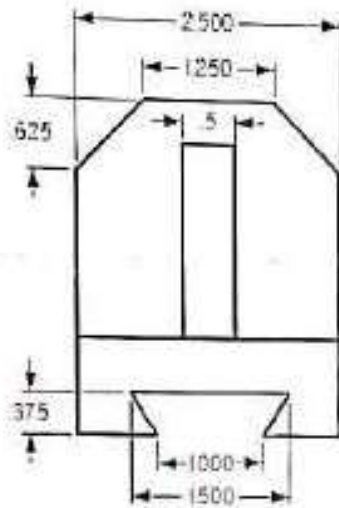

PRINCIPAL
 MAHARAJA
 25/11/2021

Handwritten signature

Department of Civil Engineering
Auto CAD Technical Training student attendance list 2020-21

S.No	Hall Ticket No	Name of the Candidate	Year	Marks	Pass/Fail
1	19E31A0101	AVARI DEEPA	II	15	Pass
2	19E31A0102	B LALITH RAJ	II	16	Pass
3	19E31A0103	BODA RAJESH	II	15	Pass
4	19E31A0104	D SAKETH	II	15	Pass
5	19E31A0105	GANGADHARI ARAVIND	II	17	Pass
6	19E31A0106	GANTA SHRAVAN KUMAR	II	16	Pass
7	19E31A0107	HAFAZUDDIN MOHAMMED ABDULLAH	II	16	Pass
8	19E31A0108	HANUMANTHU ABHISHEK	II	17	Pass
9	19E31A0109	JARSINGI CHANDRAMOULI	II	15	Pass
10	19E31A0110	JERIPOTHULA HARSHAVARDHAN MOURYA	II	15	Pass
11	19E31A0111	JUVERIA MAHVEEN	II	16	Pass
12	19E31A0112	KALAL VINAY GOUD	II	15	Pass
13	19E31A0113	KATROTHI SRINATHI	II	18	Pass
14	19E31A0114	KUMMARI YASHIWANTHI	II	18	Pass
15	19E31A0115	KURASAM ANU	II	13	Pass
16	19E31A0116	LAKAVATH GANESHI	II	14	Pass
17	19E31A0117	MARSAKATLA KEERTHI	II	15	Pass



PRINCIPAL
MAHAVEER
 INSTITUTE OF SCIENCES & TECHNOLOGY
 Bandlaguda, Hyderabad-500082

18	19E31A0118	MOHD FAIZ UDDIN	II	15	Pass
19	19E31A0119	MOHD MISBAHUDDIN	II	16	Pass
20	19E31A0120	N SHIVA SHANKER	II	16	Pass
21	19E31A0121	NENAVATH NIKHIL	II	15	Pass
22	19E31A0122	PAVULOORI MAHESH	II	16	Pass
23	19E31A0123	PERUMALLA RACHANA	II	17	Pass
24	19E31A0124	RAJAPURAM CHAITANYA KRISHNA REDDY	II	15	Pass
25	19E31A0126	VANKDOTH SRIKANTH	II	15	Pass
26	19E31A0127	WAJAHAH MOHD KHAN	II	15	Pass
27	19E31A0128	SHAIK ANAS HASHIM	II	16	Pass
28	18E31A0111	GURRAPUSALA VINITH	II	15	Pass
29	18E31A0115	MOHMMAD YAKUB NADEEM	II	16	Pass
30	18E31A0123	R BALRAJ	II	16	Pass
31	18E31A0125	RAYKODE NIKHIL	II	17	Pass
32	18E31A0127	R BHARATH	II	18	Pass
33	17E31A0115	G ROHITH VARMA	II	18	Pass
34	20E35A0101	KANJARLA AJAY	II	16	Pass
35	20E35A0103	RANAM ABHINAYA	II	18	Pass
36	20E35A0104	RASALA SANDHYA	II	18	Pass



Principal
PRINCIPAL
M. VEER
 Principal, ... & ...
 Gandlaguda, Hyderabad-500 005

Vysapuri, Bandlaguda Post, Keshavpuri,
Hyderabad-500 005, Telangana INDIA
Tel: 048-64496979, 20020773, Fax: 048-24455003
E-mail: principal.mahaveer@gmail.com
Website: www.mist.ac.in

MAHAVEER

INSTITUTE OF SCIENCE & TECHNOLOGY
Approved by AICTE, Affiliated to JNTUH, Hyd.



Auto CAD COURSE

Summary

Department of Civil Engineering

- Use AutoCAD for daily working process.
- Navigate throughout AutoCAD using major navigating tools.
- Understand the concept and techniques to draw.
- Create multiple designs using several of tools.
- Create layers to control the objects' visibility.
- Explain drawing using annotations.
- Plot or print the drawing by scale.



PRINCIPAL
MAHAVEER
INSTITUTE OF SCIENCE & TECHNOLOGY
Bandlaguda, Hyd-500 005

Vysapuri, Bandlaguda Post-Kothavdi,
Hyderabad-500 005, Telangana INDIA
Tel: 040-64596573,20026773, Fax: 040-24455003
E-mail: principal.mahaveer@gmail.com
Website: www.mist.ac.in

MAHAVEER

INSTITUTE OF SCIENCE & TECHNOLOGY
Approved by AICTE. Affiliated to JNTUH, Hyd



CERTIFICATE OF COURSE COMPLETION

This certificate is presented to _____ of MIST, who has successfully completed technical training course on "Auto CAD" held from _____ to _____ and found the student performance to be excellent.



ESTD : 2001

Ch. Swethamber

HOD

Civil Department



PRINCIPAL
MAHAVEER
INSTITUTE OF SCIENCE & TECHNOLOGY
Bandlaguda, Hyderabad - 500 005

Vysapuri, Bandlaguda Post, Keshavnagar,
Hyderabad-500 005, Telangana INDIA
Tel: 040-64596979, 10629773, Fax: 040-24455003
E-mail: principal.mahaveer@gmail.com
Website: www.mva.ac.in

MAHAVEER

INSTITUTE OF SERVICE & TECHNOLOGY
Approved by AICTE, Affiliated to JNTU/Hyd



DEPARTMENT OF CIVIL ENGINEERING

PROPOSAL LETTER

Hyderabad,

16/04/2020.

To,
The principal,
MIST,
Hyderabad.

Sub: Proposal for three weeks workshop on REVIT-Reg,

Dear Sir,

We are working as asst professor in the department of CIVIL ENGINEERING. Sir, we are going to conduct three weeks workshop on REVIT. We require your approval to go head for further proceeding and hope to get an opportunity to serve you the best .

With thanks and Regards



PRINCIPAL
MAHAVEER
INSTITUTE OF SERVICE & TECHNOLOGY
Bandlaguda, Hyd-500 005.

From,
Civil Department
Mist,
Bandlaguda,

Vysapuri, Bandlaguda Post:Keshavgiri,
Hyderabad-500 005, Telangana INDIA
Tel: 040-64596979,20020773, Fax: 040-24458003
E-mail: principal.mahaveer@gmail.com
Website: www.mist.ac.in,

MAHAVEER
INSTITUTE OF SCIENCE & TECHNOLOGY
Approved by AICTE, Affiliated to JNTUH, Hyd.



Date: 04.05.2020

CIRCULAR

Technical Training for II B. Tech students are starting from 4th MAY, 2020 onwards. All HODs and Placements coordinators have to manage the trainings and ensure 95% attendance all through the sessions.

All Mentors need to send the compiled feedback report to CH.Swethamber, HOD at c3hod.civil@gmail.com daily.

Agenda: 1. Introduction to Revit.

Designed By:-B.RAMANA KUMAR

CH.HEMALATHA

CH.SWETHAMBER



PRINCIPAL
MAHAVEER
INSTITUTE OF SCIENCE & TECHNOLOGY
Bandlaguda, 500 005



REVIT SYLLABUS

DAY	SUBJECT	KEYWORD
Day-1	Introduction to BIM & Autodesk Revit	1.IntroductiontoBIM&Revit 2.Version ofRevit 3.Starting Projects 4.User Interface
Day-2	SettingupLevels&wall, addingcomponents	1.Making Levels 2.wall setup 3. 3D Componets (Interior & Exterior)
Day-3	Working with basic tools	9.Basic modify tools Moving,Copying,Mirror,Trim. 10. Workingwithaddition/modifytools
Day-4	Modelling Floors, Roofs, Stairs, Railings, Ceiling	1.Making floor & roof 2.Creating & Modifying stairs 3.Creating Railing 4.Adding Ceiling
Day-5	Working with Grid & Column	1.Creating & modify the Grid 2.Adding Column
Day-6	Working with Materials	1.Setting of Materials 2.Apply Texture & Colour
Day-7	Creating Construction Documents	9.Making Sheetfile 10. Adding planes, elevations, section, 3D views
Day-8	Making Walkthrough	1.Use of camera 2.Making Animation
Day-9	Introduction to Revit Structure	1.Starting Projects 2.Overview of the interfece
Day-10	Startling structural project & basic modify tools	1.SettingofLevels&Grids 2.workingwithbasictools (Move, Rotate, Copy, Mirror)
Day-11	Working with views	1. Setting the view display 2.CreatingElevation§ion
Day-12	Structural Grids & Columns	1.Adding Grids 2.Placing Columns
Day-13	Foundation	1.Modelling walls 2.Adding wall footing 3.Adding Isolated footing
Day-14	Adding Structural Slab	1.Creating & modify Slab
Day-15	Structural Reinforcement	1.Structural Reinforcement 2.Adding Rebar 3.Modify Rebar 4.Reinforcing Slabs

(Handwritten signature)
PRINCIPAL
MAHAVEER INSTITUTE OF SCIENCE & TECHNOLOGY
BANDLAGUDA, HYDERABAD

Vysapuri, Bandlaguda Post, Keshavgiri,
Hyderabad-500 005, Telangana INDIA
Tel: 040-64596979, 20020773, Fax: 040-24455003
E-mail: principal_mahaveer@gmail.com
Website: www.mist.ac.in

MAHAVEER
INSTITUTE OF SCIENCE & TECHNOLOGY
Approved by AICTE, Affiliated to JNTUH, Hyd.



Department of Civil Engineering
Revit Technical Training student attendance list 2020-2021

SL.NO.	ROLL NO.	NAME OF THE STUDENT	YEAR
1	19E31A0101	AVARI DEEPA	II
2	19E31A0102	B LALITH RAJ	II
3	19E31A0103	BODA RAJESH	II
4	19E31A0104	D SAKETH	II
5	19E31A0105	GANGADHARI ARAVIND	II
6	19E31A0106	GANTA SHRAVAN KUMAR	II
7	19E31A0107	HAFAZUDDIN MOHAMMED ABDULLAH	II
8	19E31A0108	HANUMANTHU ABHISHEK	II
9	19E31A0109	JARSINGI CHANDRAMOULI	II
10	19E31A0110	JERIPOTHULA HARSHAVARDHAN MOURYA	II
11	19E31A0111	JUVERIA MAHVEEN	II
12	19E31A0112	KALAL VINAY GOUD	II
13	19E31A0113	KATROTH SRINATH	II
14	19E31A0114	KUMMARI YASHWANATH	II
15	19E31A0115	KURASAM ANU	II
16	19E31A0116	LAKAVATH GANESH	II
17	19E31A0117	MARSAKATLA KEERTHI	II
18	19E31A0118	MOHD FAIZ UDDIN	II



PRINCIPAL
MAHAVEER

INSTITUTE OF SCIENCE & TECHNOLOGY
Bandlaguda, Hyd-500 005.



19	19E31A0119	MOHD MISBAHUDDIN	
20	19E31A0120	N SHIVA SHANKER	
21	19E31A0121	NENAVATH NIKHIL	
22	19E31A0122	PAVULOORI MAHESH	
23	19E31A0123	PERUMALLA RACHANA	
24	19E31A0124	RAJAPURAM CHAITANYA KRISHNA REDDY	
25	19E31A0126	VANKDOTH SRIKANTH	
26	19E31A0127	WAJAHAH MOHD KHAN	
27	19E31A0128	SHAIK ANAS HASHIM	
28	20E35A0101	KANJARLA AJAY	
29	20E35A0103	RANAM ABHINAYA	
30	20E35A0104	RASALA SANDHYA	
31	17E31A0115	G ROHITH VARMA	
32	18E31A0111	GURRAPUSALA VINITH	
33	18E31A0115	MOHMMAD YAKUB NADEEM	
34	18E31A0123	R BALRAJ	
35	18E31A0125	RAYKODE NIKHIL	
36	18E31A0127	R BHARATH	



PRINCIPAL
MAHAVEER

PRINCIPAL
MAHAVEER
6312024, Hyd-500 005.



Department of Civil Engineering
Revit Technical Training student attendance list 2020-2021

SLNO	Roll No	Name of the student	1	2	3	4	5	6	7	8	9	10	11	12	13	14	15
1	19E31A0101	AVARI DEEPA	P	P	P	P	P	P	P	P	P	P	P	P	P	P	P
2	19E31A0102	B LALTH RAJ	P	A	P	P	P	P	P	P	P	P	P	P	P	P	P
3	19E31A0103	BODA RAJESH	P	P	P	P	P	P	P	P	P	P	P	P	P	P	P
4	19E31A0104	D SAKETH	A	P	P	P	P	P	P	P	P	P	P	P	P	P	P
5	19E31A0105	GANGADHARTARAVIND	A	A	P	P	P	P	P	P	P	P	P	P	P	P	P
6	19E31A0106	GANTA SHRAVAN KUMAR	P	P	P	P	P	P	P	P	P	P	P	A	P	P	P
7	19E31A0107	MAFAZUDDIN MOHAMMED ABDULLAH	P	P	P	P	A	P	P	P	P	A	P	P	P	P	P
8	19E31A0108	HANUMANTHU ABHISHEK	P	P	P	P	P	P	P	P	P	P	A	P	P	A	P
9	19E31A0109	JARSINGI CHANDRAMOULI	P	P	P	P	P	A	P	P	P	P	P	P	P	P	A
10	19E31A0110	JERIPOTHULA HARSHAVARDHAN MOURYA	P	P	P	A	P	P	P	P	A	P	P	P	P	P	P
11	19E31A0111	JUVERIA MAHVEEN	P	P	P	P	P	P	P	P	P	P	A	A	P	P	P
12	19E31A0112	KALAL VINAY GOUD	P	P	P	P	P	A	P	P	P	P	P	P	P	P	P
13	19E31A0113	KATROTH SRINATH	P	P	P	P	P	P	P	P	P	P	A	P	P	P	P
14	19E31A0114	KUMMARI YASHWANTH	P	A	P	P	P	P	P	P	P	P	P	P	P	P	A
15	19E31A0115	KURASAM ANU	P	P	P	P	P	P	P	P	P	P	P	A	P	P	P
16	19E31A0116	LAKAVATH GANESH	P	P	A	P	P	P	P	P	P	P	P	P	P	P	P



Principals
Principals

PRINCIPAL
MAHAVEER
DEPARTMENT OF SCIENCE & TECHNOLOGY
JNTU Hyderabad, Hyd-500 005.

2. Draw the given centre to centre floor plan into 3D model by using Revit software.

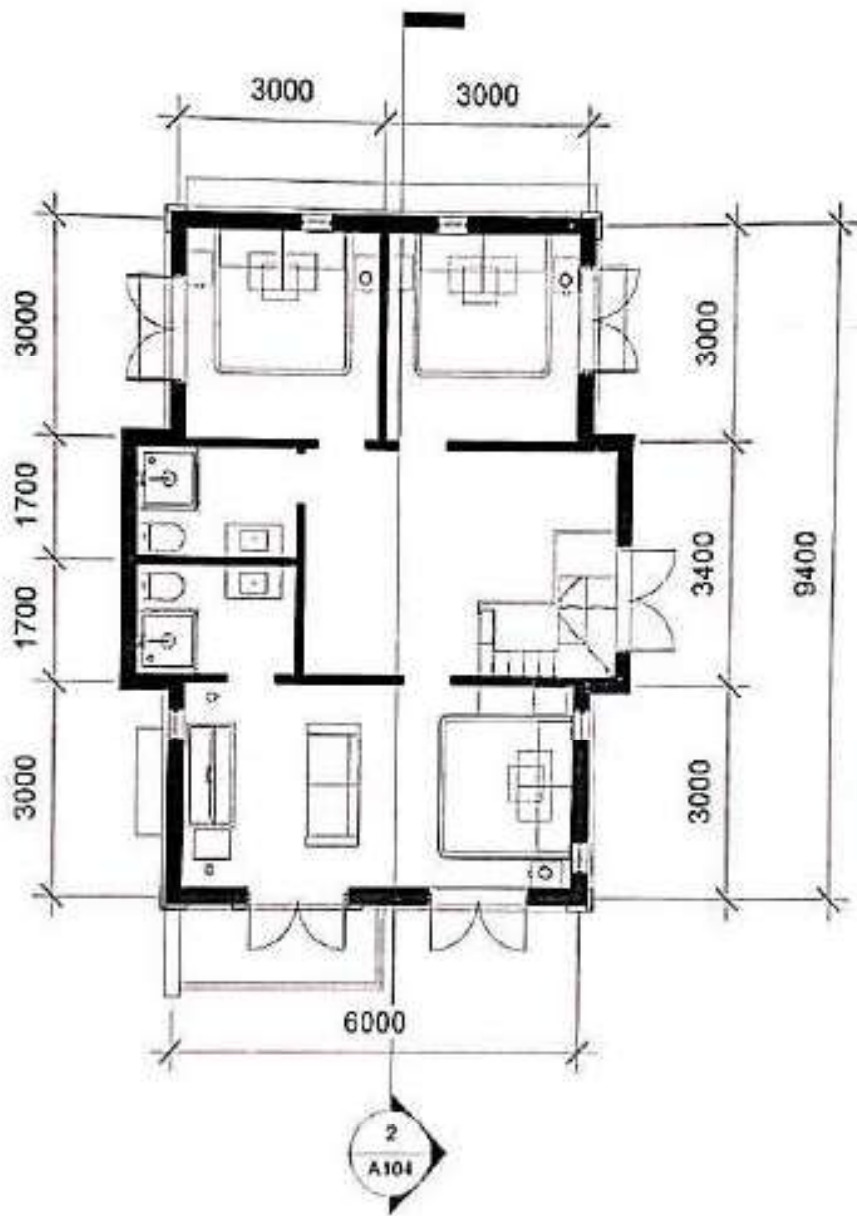

Ben Singh
PRINCIPAL
JANAVLE
INSTITUTE OF SCIENCE & TECHNOLOGY
M. Chandigarh, Pin-160 505 (INDIA)



Vysapuri, Bandlaguda Post Keshavgiri,
Hyderabad-500 005, Telangana INDIA
Tel: 040-64596979, 20020773, Fax: 040-24455903
E-mail: principal.mahaveer@gmail.com,
Website: www.mst.ac.in,

MAHAVEER

INSTITUTE OF SCIENCE & TECHNOLOGY
Approved by AICTE, Affiliated to JNTUH, Hyd.



Department of Civil Engineering
Revit Technical Training student Marks list 2020-21

Sl.NO	Roll No	Name of the student	YEAR	MARKS	PASS/FA
1	19E31A0101	AVARI DEEPA	II	16	PASS
2	19E31A0102	B LALITH RAJ	II	16	PASS
3	19E31A0103	BODA RAJESH	II	12	PASS
4	19E31A0104	D SAKETH	II	12	PASS
5	19E31A0105	GANGADHARI ARAVIND	II	16	PASS
6	19E31A0106	GANTA SHRAVAN KUMAR	II	16	PASS
7	19E31A0107	HAFAZUDDIN MOHAMMED ABDULLAH	II	16	PASS
8	19E31A0108	HANUMANTHU ABHISHEK	II	16	PASS
9	19E31A0109	JARSINGI CHANDRAMOULI	II	16	PASS
10	19E31A0110	JERIPOTHULA HARSHAVARDHAN MOURYA	II	16	PASS
11	19E31A0111	JUVERIA MAHVEEN	II	16	PASS
12	19E31A0112	KALAL VINAY GOUD	II	16	PASS
13	19E31A0113	KATROTH SRINATH	II	16	PASS
14	19E31A0114	KUMMARI YASHWANTH	II	16	PASS
15	19E31A0115	KURASAM ANU	II	16	PASS
16	19E31A0116	LAKAVATH GANESH	II	16	PASS
17	19E31A0117	MARSAKATLA KEERTHI	II	16	PASS
18	19E31A0118	MOHD FAIZ UDDIN	II	16	PASS
19	19E31A0119	MOHD MISBAHUDDIN	II	15	PASS

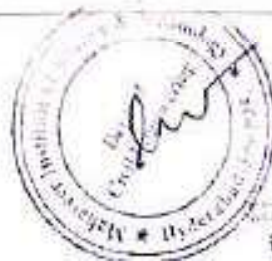

[Handwritten Signature]

PRINCIPAL
MAHAVEER

INSTITUTE OF SCIENCE & TECHNOLOGY
Bandlaguda, Hyd-500 005.

20	19E31A0120	N SHIVA SHANKER	II	16	PASS
21	19E31A0121	NENAVATH NIKHIL	II	16	PASS
22	19E31A0122	PAVULOORI MAHESH	II	15	PASS
23	19E31A0123	PERUMALLA RACHANA	II	16	PASS
24	19E31A0124	RAJAPURAM CHAITANYA KRISHNA REDDY	II	14	PASS
25	19E31A0126	VANKDOTH SRIKANTH	II	15	PASS
26	19E31A0127	WAJAHAH MOHD KHAN	II	15	PASS
27	19E31A0128	SHAIK ANAS HASHIM	II	16	PASS
28	20E35A0101	KANJARLA AJAY	II	14	PASS
29	20E35A0103	RANAM ABHINAYA	II	16	PASS
30	20E35A0104	RASALA SANDHYA	II	15	PASS
31	17E31A0115	G ROHITH VARMA	II	14	PASS
32	18E31A0111	GURRAPUSALA VINITH	II	18	PASS
33	18E31A0115	MOHMMAD YAKUB NADEEM	II	15	PASS
34	18E31A0123	R BALRAJ	II	16	PASS
35	18E31A0125	RAYKODE NIKHIL	II	15	PASS
36	18E31A0127	R BHARATH	II	16	PASS

 PRINCIPAL
 MAHA VEER
 DEPARTMENT OF SCIENCE & TECHNOLOGY
 BSRMANGALURU, Hyd. 500 005.



Vysapuri, Bandlaguda Post, Keshavnagar,
Hyderabad-500 805, Telangana INDIA
Tel: 040-64596979, 20020773, Fax: 040-24455003
E-mail: principal.mahaveer@gmail.com,
Website: www.mist.ac.in,

MAHAVEER

INSTITUTE OF MANAGEMENT & TECHNOLOGY
Approved by AICTE, Affiliated to JNTUH, Hyd.



Revit COURSE
Summary

Department of Civil Engineering

- Use Revit for daily working process.
- Navigate throughout Revit using major navigating tools.
- Understand the concept and techniques to draw.
- Create multiple designs using several of tools.
- Create layers to control the objects' visibility.
- Explain drawing using annotations.
- Plot or print the drawing by scale.
- To use constraint for certain design.

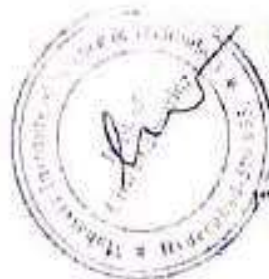

Praveen Kumar

PRINCIPAL
MAHAVEER

INSTITUTE OF MANAGEMENT & TECHNOLOGY
VYSAPURI, BANDLAGUDA, HYD-500 805.

Vysapuri, Bandlaguda Post Keshavnagar,
Hyderabad-500 005, Telangana INDIA
Tel: 040-64556579, 20020773, Fax: 040-24455003
E-mail: principal.mahaveer@gmail.com,
Website: www.mist.ac.in

MAHAVEER

INSTITUTE OF SCIENCE & TECHNOLOGY

Approved by AICTE, Affiliated to JNTUH Hyd.



CERTIFICATE OF COURSE COMPLETION

This certificate is presented to _____ of
MIST, who has successfully completed technical training course on
"Revit" held from _____ to _____ and found the
student performance to be excellent.



ESTD : 2001

CHLSWETHAMBER

HOD

Civil Department



Principal Mahaveer

PRINCIPAL

MAHAVEER

INSTITUTE OF SCIENCE & TECHNOLOGY

Bandlaguda, Hyd-500 005.

Vysapuri, Bandlaguda Post: Keshavgiri,
Hyderabad-500 005, Telangana INDIA
Tel: 040-64595979, 20020773, Fax: 040-26455063
E-mail: principal.mahaveer@gmail.com
Website: www.mist.ac.in

MAHAVEER

INSTITUTE OF SCIENCE & TECHNOLOGY

Approved by AICTE, Affiliated to JNTUH, Hyd.



DEPARTMENT OF CIVIL ENGINEERING

PROPOSAL LETTER

Hyderabad,

16/09/2020.

To,
The principal,
MIST,
Hyderabad.

Sub: Proposal for three weeks workshop on ETABS-Reg,

Dear Sir,

We are working as asst professor in the department of CIVIL ENGINEERING. Sir, we are going to conduct three weeks workshop on ETABS. We require your approval to go head for further proceeding and hope to get an opportunity to serve you the best.

With thanks and Regards

From,
Civil Department
Mist,
Bandlaguda,



PRINCIPAL
MAHAVEER
INSTITUTE OF SCIENCE & TECHNOLOGY
Bandlaguda, Hyd-500 005.

Vysapuri, Bandlaguda Post, Keshavgiri,
Hyderabad-500 005, Telangana INDIA
Tel: 040-64596979, 20020773, Fax: 040-24455003
E-mail: principal.mahaveer@gmail.com
Website: www.mist.ac.in

MAHAVEER

INSTITUTE OF SCIENCE & TECHNOLOGY
Approved by AICTE, Affiliated to JNTUH, Hyd.



DEPARTMENT OF CIVIL ENGINEERING

CIRCULAR

Hyderabad.

Date: 23.09.2020

Technical Training for III B. Tech students are starting from 23-09-2020 onwards. All HODs and Placements coordinators have to manage the trainings and ensure 95% attendance all through the sessions.

All Mentors need to send the compiled feedback report to Ch.Swethamber, HOD at e3hod.civil@gmail.com daily.

Agenda: 1. Introduction to ETABS.

CH.SWETHAMBER

HOD

Designed by : B.VARALAXMI

CH.HEMALATHA

PRINCIPAL
MAHAVEER
INSTITUTE OF SCIENCE & TECHNOLOGY
Bandlaguda, Hyderabad





DEPARTMENT OF CIVIL ENGINEERING

ETABS SYLLABUS

- 1: The knowledge about specialized software such as ETABS, SAFE to model and analyze for buildings.
- 2: Be able to model, analyze, and solve structural models on Specialized software and access analysis results such as force, Displacement and another parameter for structural design.
- 3: Be able to communicate and work in the group flexibly and Efficiently.
- 4: Explaining concepts, terminology and rules used in ETABS, SAFE software.
- 5: Modeling and analyzing type of simple and complex structural Systems.
- 6: Analyzing and determining the values of internal forces, Displacements and other parameters for structural design.
- 7: Working in the group to solve the problems relates to using Software ETABS, SAFE.
- 8: Choosing appreciable communication skills such as speech, Text, images, graphics, when expressing personal views.

Principal
PRINCIPAL
MAHAVEER
INSTITUTE OF SCIENCE & TECHNOLOGY
BANDLAGUDA, HYD-500005

Vysapuri, Bandlaguda Post:Keshavgi,
Hyderabad-500 005, Telangana INDIA
Tel: 040-84596979,20020773, Fax: 040-24455903
E-mail: principal.mahaveer@gmail.com,
Website: www.mist.ac.in,

MAHAVEER

INSTITUTE OF SCIENCE & TECHNOLOGY
Approved by AICTE, Affiliated to JNTUH, Hyd.



DEPARTMENT OF CIVIL ENGINEERING

ETABS Technical Training student Marks list 2020-2021

S.No	Hall Ticket No	Name of the Candidate
1	18E31A0101	ASRILEKHA
2	18E31A0102	BIHUKYAANILNAYAK
3	18E31A0103	CHETPELLYSANJEEV
4	18E31A0105	DHARAVATHJAYASIMHA
5	18E31A0106	DHARAVATHKALYAN
6	18E31A0107	DHARAVATHTARUNKUMARJADAV
7	18E31A0108	DURGAMYUVAKUMAR
8	18E31A0109	GOPUHARSHAVARDHANREDDY
9	18E31A0112	JABUVIVEK
10	18E31A0116	MOHAMMEDMUJAHED
11	18E31A0118	MOHDABDULWAJAHATHI
12	18E31A0119	MUJTABAALIATIF
13	18E31A0120	NUNAVATHINAVEENRAM
14	18E31A0121	PEDDOLAPREMSAI
15	18E31A0122	RAMAGIRICHARAN
16	18E31A0124	RAVUBASHANKER



PRINCIPAL
MAHAVEER
INSTITUTE OF SCIENCE & TECHNOLOGY
Bandlaguda Post, Hyderabad - 500 005.

Vysapuri, Bandlaguda Post:Keshavnagar,
Hyderabad-500 005, Telangana INDIA
Tel: 040-64596979,20020773, Fax: 040-24455003
E-mail: principal.mahaveer@gmail.com
Website: www.mist.ac.in

MAHAVEER

INSTITUTE OF SCIENCE & TECHNOLOGY

Approved by AICTE, Affiliated to JNTUH,Hyd.



17	18E31A0128	SHAGABHEEMREDDY
18	18E31A0129	SOMARAMAKASH
19	18E31A0130	SYEDFAISALHASSAN
20	18E31A0131	YARRANAGULAVEERENDAR
21	19E35A0101	AGIRISHETTYVIVEKVARDHAN
22	19E35A0102	BEERLAVINOD
23	19E35A0103	CHEGURIGOUTHAMGOUD
24	19E35A0104	DARIPALLINARMADA
25	19E35A0106	GALIRAKESH
26	19E35A0107	KINNERATARUNKUMAR
27	19E35A0108	KOTHAKARTHIKGOUD
28	19E35A0109	KUMMARISAIKISHORE
29	19E35A0110	KUMMARISRISAILAM
30	19E35A0111	MARUN
31	19E35A0112	MADAMSHETTI HEMANTH
32	19E35A0113	MOHAMMEDABDULPARVEZ
33	19E35A0114	MOHAMMEDAL THAF
34	19E35A0115	MUNAGAPATIBHARATHI
35	19E35A0116	NENAVATHSHIRISHA



[Signature]
PRINCIPAL
MAHAVEER
INSTITUTE OF SCIENCE & TECHNOLOGY
VYSAPURI, BANDLAGUDA POST, KESHAVNAGAR,
HYDERABAD-500 005, TELANGANA INDIA
Tel: 040-64596979, 20020773, Fax: 040-24455003
E-mail: principal.mahaveer@gmail.com
Website: www.mist.ac.in

Vysapuri, Bandlaguda Post: Keshavpuri,
Hyderabad-500 005, Telangana INDIA
Tel: 040-84596979, 20020773, Fax: 040-24455003
E-mail: principal.mahaveer@gmail.com,
Website: www.mist.ac.in,

MAHAVEER

INSTITUTE OF SCIENCE & TECHNOLOGY
Approved by AICTE, Affiliated to JNTUH, Hyd



36	19E35A0117	POTLACHERUVUNAVEEN
37	19E35A0118	PUTTAGUNTASRILATHA
38	19E35A0119	SADVIKAJILLA
39	19E35A0120	SINGARAMNARSINGRAO
40	19E35A0121	THOTLAJAYANTH
41	17E31A0104	BATHULARAVITEJA
42	17E31A0111	DAMMALARAKESHI
43	17E31A0130	MUSHANSHIVAKUMAR
44	17E31A0133	OWAISBINHASSAN
45	17E31A0145	YOUSUFMOHAMMEDKHAN
46	17E31A0114	ESSAMKAVYA
47	15E31A0139	SYEDYAQOOBHUSSAINSHAHQUADRI
48	15E31A0102	ABDULGAFFER



PRINCIPAL
MAHAVEER
INSTITUTE OF SCIENCE & TECHNOLOGY
Bandlaguda, Hyd-500 005.

MAHAVEER INSTITUTE OF SCIENCE & TECHNOLOGY, HYDERABAD

CIVIL ENGINEERING STUDENTS ATTENDANCE

B.TECH III YEAR I SEM 2020-2021 BATCH (Date: 23-9-2020 to 3-10-2020)

S.No	Hall Ticket No	Name of the Candidate	1	2	3	4	5	6	7	8	9	10
1	18E31A0101	ASRHEKHA	P	P	P	P	A	P	P	P	P	P
2	18E31A0102	BHUKYAAANILNAYA K	P	P	A	P	P	P	P	P	P	P
3	18E31A0103	CHEPPELLYSANJEEV	P	A	P	P	P	P	P	P	P	P
4	18E31A0105	DHARAVATHJAYASI MILA	P	P	P	P	P	A	P	P	P	P
5	18E31A0106	DHARAVATHKALYA N	P	P	P	A	P	P	P	P	P	P
6	18E31A0107	DHARAVATHITARUN KUMARJADAV	P	P	P	P	P	P	A	P	P	P
7	18E31A0108	DURGAMYUVAKUM AR	P	P	P	P	P	P	P	P	P	A
8	18E31A0109	GOPULARSHAVARD HANREDDY	P	P	A	P	P	P	P	P	P	P
9	18E31A0112	JABUVIVEK	P	P	P	P	P	P	P	A	P	P
10	18E31A0116	MOHAMMEDMUJAHID	P	P	P	A	P	P	P	P	P	P
11	18E31A0118	MOHDABDULWAJAH ATH	P	P	P	P	P	P	P	P	A	P
12	18E31A0119	MUJTABAALIATIF	P	P	P	A	P	P	P	P	P	P
13	18E31A0120	NUNAVATHINAVEEN RAM	A	P	P	P	P	P	P	P	P	P
14	18E31A0121	PEDDLAPREMSAI	P	P	P	P	P	A	P	P	P	P
15	18E31A0122	RAMAGIRICHARAN	P	P	A	P	P	P	P	P	P	P
16	18E31A0124	RAVUBASHANKER	P	P	P	P	A	P	P	P	P	P

 Principal
 MAHAVEER
 INSTITUTE OF SCIENCE & TECHNOLOGY
 Gandhinagar, Hyderabad-500 015

21	19E35A0101	AGHISHI ETYVIVIEK VARDHAN	P	P	P	P	A	P	P	P	P	P
22	19E35A0102	BEETRI AVINOD	A	P	P	P	P	P	A	P	P	P
23	19E35A0103	KTH GJ RIGOUTHAMI GOLD	P	P	P	A	P	P	P	A	P	P
24	19E35A0104	DAARPALE INARMAID	P	P	P	P	P	A	P	P	P	P
25	19E35A0106	GATHIRAKESHI	P	P	A	P	P	P	P	P	P	P
26	19E35A0107	KINNETARUNKU MAR	P	P	P	P	P	P	A	P	P	P
27	19E35A0108	KOTIAKARTHIKGOU	A	A	P	P	P	P	P	P	P	P
28	19E35A0109	KUMMARISAINISHO	P	P	P	P	A	P	P	P	P	P
29	19E35A0110	KUMMARISRISAILA	P	P	A	P	P	A	P	P	P	P
30	19E35A0111	MARUN	A	P	A	A	P	P	P	P	P	P
31	19E35A0112	MADAMSHETTI HEMANATH	P	P	P	A	P	P	P	P	P	P
32	19E35A0113	MOHAMMEDABDULP ARVEZ	A	P	P	P	P	P	A	P	P	P
33	19E35A0114	MOHAMMEDALTHAF	P	P	A	P	P	P	A	P	P	P
34	19E35A0115	MUNAGAPATIBHARA	P	P	P	P	P	A	P	P	P	P
35	19E35A0116	NEENAVATHESHISHA	P	P	P	A	P	P	P	A	P	P
36	19E35A0117	POTLACHERUVUNAV BEN	P	P	P	P	P	A	P	P	P	P
37	19E35A0118	PULLAGUNTASRIJAT	P	A	P	P	P	P	P	P	P	P
38	19E35A0119	SADVIKAJILLA	P	P	P	A	P	P	P	P	P	P
39	19E35A0120	SINGARAMNARSING RAO	P	A	A	P	P	P	P	P	P	P
40	19E35A0121	THOLLAJAYANJI	P	P	P	P	P	P	P	P	P	P
41	17E31A0104	BAJHILAKAVIJEJA	P	A	P	P	A	P	P	P	P	A
42	17E31A0111	DASIMM APRAKISHI	P	P	P	P	P	P	P	P	P	A
43	17E31A0130	MUNSHANSHIVARAM	P	P	P	P	P	P	P	P	P	A
44	17E31A0152	OWAISHINIYASSAN	P	P	P	P	P	P	A	P	P	P



Director of Public Instruction,
Bangalore, 11-11-2019

45	17131A0145	YOUSUF MOHAMMED KHAN	P	P	P	P	P	P	P	P	P	P	P	P
46	17131A0114	ESSAMIA AVVA	A	A	P	P	P	P	P	P	P	P	P	P
47	15F31A0139	SITIY AQOUBHUSSA INSIATIQUEADRI	P	P	A	P	P	P	A	P	P	P	P	A
48	15F31A0102	ABDUL GAFFER	P	P	A	P	P	P	P	P	P	P	P	P

Signature
 17131A0145
 17131A0114
 15F31A0139
 15F31A0102





DEPARTMENT OF CIVIL ENGINEERING

Technical Training Exam on Etabs Software

[A.Y-2020-21]

2x10=20 Marks

Answer All the Questions

1) Design of composite steel using etabs

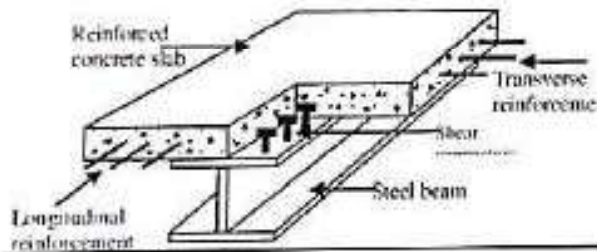

2) composite column using etabs

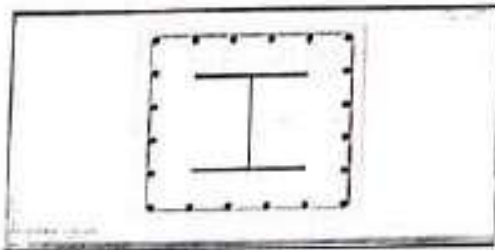

Principal Mahaveer

PRINCIPAL
MAHAVEER

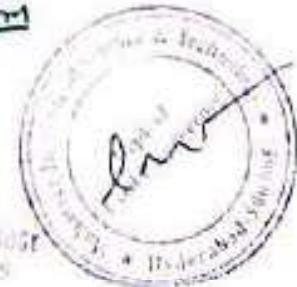



DEPARTMENT OF CIVIL ENGINEERING

ETABS Technical Training student Marks list 2020-21

Sl.NO	Hall Ticket No	Name of the Candidate	YEAR	MARKS	PASS/
1	18E31A0101	ASRILEKHA	III	16	PASS
2	18E31A0102	BHUKYAANILNAYAK	III	16	PASS
3	18E31A0103	CHETPELLYSANJEEV	III	12	PASS
4	18E31A0105	DHARAVATHJAYASIMHA	III	12	PASS
5	18E31A0106	DHARAVATHKALYAN	III	16	PASS
6	18E31A0107	DHARAVATHTARUNKUMARJADAV	III	16	PASS
7	18E31A0108	DURGAMYUVAKUMAR	III	16	PASS
8	18E31A0109	GOPUHARSHAVARDHANREDDY	III	16	PASS
9	18E31A0112	JABUVIVEK	III	16	PASS
10	18E31A0116	MOHAMMEDMUJAHED	III	16	PASS
11	18E31A0118	MOHDABDULWAJAHATH	III	16	PASS
12	18E31A0119	MUJTABAALJATIF	III	16	PASS
13	18E31A0120	NUNAVATHNAVEENRAM	III	16	PASS
14	18E31A0121	PEDDOLAPREMSAI	III	16	PASS
15	18E31A0122	RAMAGIRICHARAN	III	16	PASS
16	18E31A0124	RAVUBASHANKER	III	16	PASS
17	18E31A0128	SHAGABIHEEMREDDY	III	16	PASS
18	18E31A0129	SOMARAMAKASHI	III	16	PASS
19	18E31A0130	SYEDFAISALHASSAN	III	15	PASS
20	18E31A0131	YARRANAGULAVEERENDAR	III	16	PASS
21	19E35A0101	AGIRISHETTYVIVEKVARDHAN	III	16	PASS

PRINCIPAL
MAHAVEER
INSTITUTE OF SCIENCE & TECHNOLOGY
Bandlaguda, Hyderabad-500 005.



Vysapuri, Bandlaguda Post:Keshavgiri,
Hyderabad-500 005, Telangana INDIA
Tel: 040-64596979,20020773,,Fax: 040-24455003
E-mail: principal.mahaveer@gmail.com,
Website: www.mist.ac.in,

MAHAVEER

INSTITUTE OF SCIENCE & TECHNOLOGY

Approved by AICTE, Affiliated to JNTUH,Hyd.



22	19E35A0102	BEERLAVINOD	III	15	PASS
23	19E35A0103	CHEGURIGOUTHAMGOUD	III	16	PASS
24	19E35A0104	DARIPALLINARMADA	III	14	PASS
25	19E35A0106	GALIRAKESH	III	15	PASS
26	19E35A0107	KINNERATARUNKUMAR	III	15	PASS
27	19E35A0108	KOTIAKARTHIKGOUD	III	16	PASS
28	19E35A0109	KUMMARISAIKISHORE	III	14	PASS
29	19E35A0110	KUMMARISRISAILAM	III	16	PASS
30	19E35A0111	MARUN	III	15	PASS
31	19E35A0112	MADAMSHETTI HEEMANTH	III	14	PASS
32	19E35A0113	MOHAMMEDABDULPARVEZ	III	18	PASS
33	19E35A0114	MOHAMMEDALTHAF	III	15	PASS
34	19E35A0115	MUNAGAPATIBHARATHI	III	16	PASS
35	19E35A0116	NENAVATHSHIRISHA	III	15	PASS
36	19E35A0117	POTLACHERUVUNAVEEN	III	16	PASS
37	19E35A0118	PUTTAGUNTASRILATHA	III	15	PASS
38	19E35A0119	SADVIKAJILLA	III	16	PASS
39	19E35A0120	SINGARAMNARSINGRAO	III	15	PASS
40	19E35A0121	THOTLAJAYANTHI	III	17	PASS
41	17E31A0104	BATHULARAVITEJA	III	15	PASS
42	17E31A0111	DAMMALARAKESH	III	16	PASS
43	17E31A0130	MUSHANSIIVAKUMAR	III	15	PASS
44	17E31A0133	OWAISBINHASSAN	III	16	PASS
45	17E31A0145	YOUSUFMOHAMMEDKHAN	III	15	PASS



[Handwritten Signature]
PRINCIPAL
MAHAVEER
INSTITUTE OF SCIENCE & TECHNOLOGY
HYDARABAD-500 005

Vysapuri, Bandlaguda Post, Keshavgiri,
Hyderabad-500 005, Telangana INDIA
Tel: 040-64596979, 20020773, Fax: 040-24455003
E-mail: principal.mahaveer@gmail.com,
Website: www.mist.ac.in,

MAHAVEER

INSTITUTE OF SCIENCE & TECHNOLOGY

Approved by AICTE, Affiliated to JNTUH, Hyd.



46	17E31A0114	ESSAMKAVYA	III	15	PASS
47	15E31A0139	SYEDYAQOOBIHUSSAINSHAHQUADRI	III	15	PASS
48	15E31A0102	ABDULGAFFER	III	15	PASS



[Handwritten Signature]

PRINCIPAL
MAHAVEER

INSTITUTE OF SCIENCE & TECHNOLOGY
Bandlaguda, Hyd-500 005.

Vysavuri, Bandlaguda Post:Keshavnari,
Hyderabad-500 005, Telangana INDIA
Tel: 040-84596979,20020773, Fax: 040-24455003
E-mail: principal.mahaveer@gmail.com.
Website: www.mist.ac.in,

MAHAVEER

INSTITUTE OF SCIENCE & TECHNOLOGY

Approved by AICTE, Affiliated to JNTUH,Hyd.



DEPARTMENT OF CIVIL ENGINEERING

Etabs course

Summary

- Use ETABS for daily working process.
- Navigate throughout ETABS using major navigating tools.
- Understand the concept and techniques to draw.
- Create multiple designs using several of tools.
- Create layers to control the objects' visibility.
- Explain drawing using annotations.
- To use constraint for certain design.



PRINCIPAL
MAHAVEER

INSTITUTE

OF SCIENCE & TECHNOLOGY
BANDLAGUDA, HYDRABAD-500005

Vysapur, Bandlaguda Post:Keshavgiri,
Hyderabad-500 025, Telangana INDIA
Tel: 040-84896979,20020773, Fax: 040-24455003
E-mail: principal.mahaveer@gmail.com,
Website: www.mist.ac.in,

MAHAVEER

INSTITUTE OF SCIENCE & TECHNOLOGY
Approved by AICTE, Affiliated to JNTUH, Hyd.



CERTIFICATE OF COURSE COMPLETION

This certificate is presented to _____ of MIST, who has successfully completed technical training course on "ETABS" held from _____ to _____ and found the student performance to be excellent.



ESTD : 2001

CILSWETHAMBER

HOD

Civil Department



PRINCIPAL
MAHAVEER

INSTITUTE OF SCIENCE & TECHNOLOGY
Bandlaguda, Hyderabad-500025.

Vysaapuri, Bandlaguda Post:Keshavnagar,
Hyderabad-500 005, Telangana INDIA
Tel: 040-64595979,20020773, Fax: 040-24455003
E-mail: principal.mahaveer@gmail.com
Website: www.mist.ac.in

MAHAVEER

INSTITUTE OF SCIENCE & TECHNOLOGY
Approved by AICTE. Affiliated to JNTUH,Hyd.



PROPOSAL LETTER

Hyderabad,

3/08/2020.

To,
The principal,
MIST,
Hyderabad.

Sub: Proposal for three weeks workshop on GEOS-Reg.

Dear Sir,

We are working as asst professor in the department of CIVIL ENGINEERING. Sir, we are going to conduct three weeks workshop on GEOS. We require your approval to go head for further proceeding and hope to get an opportunity to serve you the best .

With thanks and Regards

From,
Civil Department
Mist,
Bandlaguda,
Hyderabad.

PRINCIPAL
MAHAVEER
INSTITUTE OF SCIENCE & TECHNOLOGY
Bandlaguda, Hyderabad-500 005



Vysapuri, Bandlaguda Post: Keshavpuri,
Hyderabad-500 005, Telangana INDIA
Tel: 040-64596979, 20920773, Fax: 040-24455003
E-mail: principal.mahaveer@gmail.com,
Website: www.mist.ac.in

MAHAVEER
INSTITUTE OF SCIENCE & TECHNOLOGY
Approved by AICTE, Affiliated to JNTUHyd.



Date: 10.08.2020

CIRCULAR

Technical Training for II B. Tech students are starting from 24 TH AUGUST, 2020 onwards.
All HODs and Placements coordinators have to manage the trainings and ensure 95% attendance
all through the sessions.

All Mentors need to send the compiled feedback report to CH.SWETHAMBER, HOD at
e3hod.civil@gmail.com daily.

Agenda: I. Introduction to GEOS SOFTWARE

CH.SWETHAMBER

HOD



Design by: K.SAI PRADEEP

DR.M.VASANTHA LAXMI

PRINCIPAL
MAHAVEER
INSTITUTE OF SCIENCE & TECHNOLOGY
Bandlaguda, Hyd-500 005.

Vysapuri, Bandlaguda Post: Keshavgiri,
Hyderabad-500 005, Telangana INDIA
Tel: 040-64596979, 20020773, Fax: 040-24459603
E-mail: principal.mahaveer@gmail.com,
Website: www.mist.ac.in

MAHAVEER
INSTITUTE OF SCIENCE & TECHNOLOGY
Approved by AICTE, Affiliated to JNTUH Hyd.



GEO5 SYLLABUS

Getting started with GEO5 SOFTWARE

- 1) Design of a cantilever wall
- 2) Verification of a gravity wall
- 3) Design of a non-anchored retaining wall
- 4) Design of an anchored retaining wall
- 5) Verification of a multi anchored wall
- 6) Slope stability analysis
- 7) Design of the geometry of a spread footing
- 8) Settlement of a spread footing
- 9) Analysis of a consolidation under embankment
- 10) Pile foundations-introduction

PRINCIPAL
MAHAVEER
INSTITUTE OF SCIENCE & TECHNOLOGY
Bandlaguda, Hydr-500 005.



Vysapuri, Bandlaguda Post: Keshavnagar,
Hyderabad-500 005, Telangana INDIA
Tel: 040-64896979, 20020773, Fax: 040-24455003
E-mail: principal.mahaveer@gmail.com
Website: www.mist.ac.in

MAHAVEER

INSTITUTE OF SCIENCE & TECHNOLOGY
Approved by AICTE, Affiliated to JNTUH, Hyd.



MAHAVEER INSTITUTE OF SCIENCE & TECHNOLOGY, HYDERABAD.

IV CIVIL BRANCH 2020-21 BATCH

SL No.	Hall Ticket No	Name	Year
1	17E31A0101	ANNALDAS JANAKI	IV
2	17E31A0102	ARSHI FIRDAUSH	IV
3	17E31A0103	B SOHAN LAL	IV
4	17E31A0105	BHUKYA RAJU	IV
5	17E31A0106	BHUKYA RAVIKUMAR	IV
6	17E31A0107	BOLLAM VIJAY KUMAR	IV
7	17E31A0108	CHELUMALLA VIKAS REDDY	IV
8	17E31A0109	CHENNAKESHI MANIKANTA MUDHIRAJ	IV
9	17E31A0110	D TEJA	IV
10	17E31A0113	DEVALLA SMARANI	IV
11	17E31A0116	HALAVATH HARI KRISHNA	IV
12	17E31A0121	M A GHANIUDDIN	IV
13	17E31A0122	MADDELA ARUN KUMAR	IV
14	17E31A0125	MOHAMMED MUQTAR PATEL	IV
15	17E31A0128	MOHD MAJEED UDDIN	IV
16	17E31A0135	PAKALA SAI PRASAD	IV
17	17E31A0138	SHARAVATHI SREEDHIER	IV
18	17E31A0139	SHIVARATRIN KUMAR	IV

PRINCIPAL
MAHAVEER
INSTITUTE OF SCIENCE & TECHNOLOGY
Bandlaguda, Hyd-500 005.



19	17E31A0140	SIDDAMSETTI AVINASH	IV
20	17E31A0141	SK REHMATHBABA	IV
21	17E31A0142	SUNKARA HARSHAVARDHAN	IV
22	17E31A0143	TURUKA PAVANI	IV
23	17E31A0144	YATHAM SAI YASHASWINI	IV
24	18E35A0101	ADNAN ABDUL WASE	IV
25	18E35A0102	BADALA VARA PRASAD	IV
26	18E35A0105	DONTIARABOINA KIRAN KUMAR	IV
27	18E35A0106	KOLLA KRANTHI KUMAR	IV
28	18E35A0107	MANKA TUSHAL YADAV	IV
29	18E35A0108	MERUGU ROHITH	IV
30	18E35A0109	MULLUKUNTLA MOUNIKA	IV
31	18E35A0110	POCHAGARI ALOK	IV
32	18E35A0111	P DEEPA SREE	IV
33	18E35A0112	P RAGHAVENDAR	IV
34	18E35A0113	SANDADI TEJASWINI	IV
35	18E35A0114	UPUTHALLI VENUGOPAL	IV
36	17H11A0102	ABUBAKAR	IV
37	17H11A0118	MOHAMMED ALTHAF	IV
38	17H11A0119	MOHAMMED ASIM ADNAN	IV
39	19E38A0101	GOTTIMUKKALA VENKATA ABHIGYAN SHARMA	IV

 PRINCIPAL
MAHAVEER
 INSTITUTE OF SCIENCE & TECHNOLOGY
 Bendlaguda, Hyd-500 005.



MALAVEER INSTITUTE OF SCIENCE & TECHNOLOGY, HYDERABAD
CIVIL ENGINEERING STUDENTS ATTENDANCE

B.TECH IV YEAR I SEM 2020-2021 BATCH (Date: 24-8-2020 to 4-9-2020)

S.No	Hall Ticket No	Name of the Candidate	1	2	3	4	5	6	7	8	9	10
1	17E31A0101	ANNALDAS JANAKI	P	P	P	A	P	P	P	P	P	P
2	17E31A0102	ARSHI FIRDAUSH	P	P	A	P	P	P	A	P	P	P
3	17E31A0103	B SOHAN LAL	P	P	P	P	P	P	P	P	P	P
4	17E31A0105	BHUKYA RAJU	P	P	A	P	P	P	P	P	P	P
5	17E31A0106	BHUKYA RAVIKUMAR	P	A	P	P	P	P	P	P	P	P
6	17E31A0107	BOLLAM VIJAY KUMAR	P	P	P	P	P	P	P	P	P	P
7	17E31A0108	CHELUMALLA VIKAS REDDY	P	A	P	P	P	P	A	P	P	P
8	17E31A0109	CHENNAKESHI MANIKANTA MUDHIRAJ	P	P	P	P	P	A	P	P	P	A
9	17E31A0110	D TEJA	P	P	P	A	P	P	P	P	P	P
10	17E31A0113	DEVALLA SMARANI	P	P	P	P	P	P	A	P	P	P
11	17E31A0116	HALAVATH HARI KRISHNA	A	P	P	P	A	P	P	P	P	P
12	17E31A0121	M A GHANIUDDIN	P	P	P	A	P	P	P	P	P	A
13	17E31A0122	MADELA ARUN KUMAR	P	P	P	P	P	P	P	A	P	P
14	17E31A0125	MOHAMMED MUQTAR PATEL	P	A	P	P	P	P	P	P	A	P
15	17E31A0128	MOHID MAJEED UDDIN	P	P	P	P	P	P	P	P	P	P
16	17E31A0135	PAKALA SAI PRASAD	P	A	P	P	P	P	P	P	P	P



PRINCIPAL
MALAVEER
 MALAVEER INSTITUTE OF SCIENCE & TECHNOLOGY
 GANDAPUR, HYD-506 005

Vysapuri, Bandlaguda Post:Keshavgiri,
Hyderabad-500 085, Telangana INDIA
Tel: 040-64596979,20020773, Fax: 040-24455003
E-mail: principal.mahaveer@gmail.com,
Website: www.mist.ac.in,

MAHAVEER

INSTITUTE OF SCIENCE & TECHNOLOGY
Approved by AICTE, Affiliated to JNTUH, Hyd.



Technical Training Exam on GEOS Software
(A.Y-2020-21)

2x10=20 Marks

Answer All the Questions

1. What are geotechnical services
2. How do you improve bearing capacity of soil?

PRINCIPAL
MAHAVEER
INSTITUTE OF SCIENCE & TECHNOLOGY
Bandlaguda, Hyderabad-500 085



Vysapuri, Bandlaguda Post: Keshavgiri,
Hyderabad-500 005, Telangana INDIA
Tel: 040-64598979, 20020773, Fax: 040-24455003
E-mail: principal.mahaveer@gmail.com,
Website: www.mist.ac.in.

MAHAVEER

INSTITUTE OF SCIENCE & TECHNOLOGY

Approved by AICTE, Affiliated to JNTU, Hyd.



MAHAVEER INSTITUTE OF SCIENCE & TECHNOLOGY, HYDERABAD.

IV CIVIL BRANCH 2020-21 BATCH

S.No	Hall Ticket No	Name of the Candidate	Year	Marks	Pass/Fail
1	17E31A0101	ANNALDAS JANAKI	IV	16	Pass
2	17E31A0102	ARSHI FIRDAUSH	IV	15	Pass
3	17E31A0103	B SOHAN LAL	IV	14	Pass
4	17E31A0105	BHUKYA RAJU	IV	15	Pass
5	17E31A0106	BHUKYA RAVIKUMAR	IV	12	Pass
6	17E31A0107	BOLLAM VIJAY KUMAR	IV	13	Pass
7	17E31A0108	CHELUMALLA VIKAS REDDY	IV	14	Pass
8	17E31A0109	CHENNAKESHI MANIKANTA MUDHIRAJ	IV	16	Pass
9	17E31A0110	D TEJA	IV	15	Pass
10	17E31A0113	DEVALLA SMARANI	IV	14	Pass
11	17E31A0116	HALAVATHI HARI KRISHNA	IV	13	Pass
12	17E31A0121	M A GHANIUDDIN	IV	14	Pass
13	17E31A0122	MADDELA ARUN KUMAR	IV	12	Pass
14	17E31A0125	MOHAMMED MUQTAR PATEL	IV	15	Pass
15	17E31A0128	MOHD MAJEED UDDIN	IV	14	Pass
16	17E31A0135	PAKALA SAI PRASAD	IV	15	Pass

PRINCIPAL
MAHAVEER
INSTITUTE OF SCIENCE & TECHNOLOGY
Bandlaguda, Hyd-500 005.



17	17E31A0138	SHARAVATH SREEDHER	IV	14	Pass
18	17E31A0139	SHIVARATRIN KUMAR	IV	12	Pass
19	17E31A0140	SIDDAMSETTI AVINASHI	IV	15	Pass
20	17E31A0141	SK REHMATHBABA	IV	16	Pass
21	17E31A0142	SUNKARA HARSHAVARDHAN	IV	15	Pass
22	17E31A0143	TURUKA PAVANI	IV	14	Pass
23	17E31A0144	YATHAM SAI YASHASWINI	IV	15	Pass
24	18E35A0101	ADNAN ABDUL WASE	IV	16	Pass
25	18E35A0102	BADALA VARA PRASAD	IV	15	Pass
26	18E35A0105	DONTHARABOINA KIRAN KUMAR	IV	14	Pass
27	18E35A0106	KOLLA KRANTHI KUMAR	IV	15	Pass
28	18E35A0107	MANKA TUSHAL YADAV	IV	12	Pass
29	18E35A0108	MERUGU ROHITH	IV	13	Pass
30	18E35A0109	MULLUKUNTLA MOUNIKA	IV	14	Pass
31	18E35A0110	POCHAGARI ALOK	IV	12	Pass
32	18E35A0111	P DEEPA SREE	IV	16	Pass
33	18E35A0112	P RAGHAVENDAR	IV	15	Pass
34	18E35A0113	SANDADI TEJASWINI	IV	13	Pass
35	18E35A0114	UPUTHIALI VENUGOPAL	IV	12	Pass
36	17H11A0102	ABUBAKAR	IV	13	Pass
37	17H11A0118	MOHAMMED ALTHAF	IV	14	Pass
38	17H11A0119	MOHAMMED ASIM ADNAN	IV	15	Pass
39	19E38A0101	GOTTIMUKKALA VENKATA ABHIGYAN SHARMA	IV	15	pass



PRINCIPAL
MAHAVEER
INSTITUTE OF SCIENCE & TECHNOLOGY
Bandlaguda, Hyd-500 005.



Vysapuri, Bandlaguda Post, Keshavnagar,
Hyderabad-500 005, Telangana INDIA
Tel: 940-64596973, 20020773, Fax: 940-24465003
E-mail: principal.mahaveer@gmail.com,
Website: www.mist.ac.in,

MAHAVEER
INSTITUTE OF SCIENCE & TECHNOLOGY
Approved by AICTE, Affiliated to JNTUH, Hyd.



GEO5 COURSE
Summary

Department of Civil Engineering

- Use GEO5 for daily working process.
- Navigate throughout GEO5 using major navigating tools.
- Understand the concept and techniques to draw.
- Create multiple designs using several of tools.
- Create layers to control the objects' visibility.
- Explain drawing using annotations.
- Plot or print the drawing by scale.
- To use constraint for certain design.

PRINCIPAL
MAHAVEER
INSTITUTE OF SCIENCE & TECHNOLOGY
Bandlaguda, Hyd-500 005.



Vysapuri, Bandlaguda Post:Keshavpuri,
Hyderabad-500 085, Telangana INDIA
Tel: 040-64599979,20020773, Fax: 040-24456003
E-mail: principal.mahaveer@gmail.com,
Website: www.mist.ac.in,

MAHAVEER
INSTITUTE OF SCIENCE & TECHNOLOGY
Approved by AICTE, Affiliated to JNTUH,Hyd



CERTIFICATE OF COURSE COMPLETION

This certificate is presented to _____ of MIST, who
has successfully completed technical training course on "GEO5"
held from _____ to _____ and found the student
performance to be excellent.



ESTD : 2001

PRINCIPAL
MAHAVEER
INSTITUTE OF SCIENCE & TECHNOLOGY
Bandlaguda, Hyd-500 085

CHILSWETHAMBER

HOD

Civil Department





PROPOSAL LETTER

Hyderabad,

11/03/2020.

To
The principal,
MIST,
Hyderabad.

Sub: Proposal for three weeks workshop on STADD PROVIB-Reg.

Dear Sir,

We are working as asst professor in the department of CIVIL ENGINEERING. Sir, we are going to conduct three weeks workshop on STADD PROVIB. We require your approval to go head for further proceeding and hope to get an opportunity to serve you the best.

With thanks and Regards

From,
Civil Department,
Mist,
Bandlaguda,
Hyderabad.

PRINCIPAL
MAHAVEER
INSTITUTE OF SCIENCE & TECHNOLOGY
Bandlaguda, Hyd-500 005.



Vysapuri, Bandlaguda Post:Keshavgiri,
Hyderabad-500 005, Telangana INDIA
Tel: 040-64596979,20020773, Fax: 040-24455003
E-mail: principal.mahaveer@gmail.com,
Website: www.mlst.ac.in,

MAHAVEER

INSTITUTE OF SCIENCE & TECHNOLOGY
Approved by AICTE, Affiliated to JNTUH,Hyd.



Date: 13.03.2020

CIRCULAR

Technical Training for II B. Tech students are starting from 13th March, 2020 onwards. All HODs and Placements coordinators have to manage the trainings and ensure 95% attendance all through the sessions.

All Mentors need to send the compiled feedback report to , HOD at c3hod.civil@gmail.com daily.

Agenda: I. Introduction to STAAD.ProVi8.

DESIGNED BY

B RAMANA KUMAR

M SARITHA

CH SWETHAMBER

HOD

PRINCIPAL
MAHAVEER

INSTITUTE OF SCIENCE & TECHNOLOGY
Bandlaguda, Hyd-500 005.





STAAD.Pro SYLLABUS

Chapter 1: Before you start using Bentley STAAD.ProV8i

- cc. Understanding Unit Conversion Tables
- dd. Overview of Structural Design & Analysis
- ee. Stresses and Strains
- ff. Shear Force & Bending Moment Diagrams
- gg. Introduction to Types of Structures
- hh. Overview of Steel, Concrete and Foundation Design
- ii. Introduction to Finite Element Analysis

Chapter 2: Introduction to STAAD.Pro

- ss. About Bentley STAAD.Pro
- tt. Starting STAAD.Pro
- uu. Graphical User Interface
- vv. Starting a New Project
- ww. Working with User Interface:
 - Menu Bars
 - Tool Bars
 - Tabs
 - Snap Node / Beam Window
 - Data Area
 - Main Window
- xx. Opening and Existing Project
- yy. Saving a Project
- zz. Configuring Units
- aaa. Keyboard Shortcuts
- bbb. Importing Model in STAAD.Pro
- ccc. Coordinate Systems

Chapter 3: Structural Modeling

- ss. Adding Beams using Tools
- tt. Creating Beams (Collinear, Along Axes)
- uu. Creating Plates
- vv. Creating Surfaces
- ww. Creating Solid Elements
- xx. Creating Structure
- yy. Stretching and Intersecting Members
- zz. Merging Members and Nodes
- aaa. Renumbering Nodes, Members and Elements
- bbb. Splitting and Breaking Beams
- ccc. Cutting Sections

Chapter 4: Material Constants and Section Properties

- t. Material Constants

Creating and Editing Material Properties

- u. Assigning Materials to the Structure
- v. Orthotropic Materials

Handwritten signature

PRINCIPAL
MAHAVEER
INSTITUTE OF SCIENCE & TECHNOLOGY
BANDLAGUDA POST, KESHAVNAGAR,
HYDERABAD-500 605



- w. SectionProperties
 - PrismaticSections
 - TaperedSections
 - SteelSections
 - Steel Joist and JoistGirders
 - Plate/SurfaceThickness

Chapter 5: Member Specifications and Supports

- q. NodeSpecification
- r. MemberSpecifications
 - Release
 - Offset
 - PropertyReductionfactors
 - Cable
 - Truss
 - Compression
 - Tension
 - Inactive
- s. PlateSpecifications
 - Release
 - IgnoreInplaneRotation
 - PlaneStress
- t. Supports:
 - Fixed
 - Pinned
 - FixedBut
 - Enforced
 - EnforcedBut
 - MultilinearSpring
 - Foundation
 - Inclined
 - Tension/CompressionOnlySprings

Chapter 6: Loads

- m. Types of Loads: Selfweight, Nodal, Member, Area, Floor, Plate, Surface and Solid,
- n. LoadGeneration
- o. LoadCombinations

Chapter 7: Performing Analysis

- i. PreAnalysis
 - ProblemStatistics
 - JointCoordinates
 - MemberInformation
 - MaterialProperties
 - SupportInformation
 - Element & SolidInformation
- j. PerformingAnalysis

Chapter 8: Post Processing & Report Creation

- q. Post AnalysisPrint
 - LoadLists
 - JointDisplacement
 - MemberForces
 - SupportReactions
 - CG
 - ModeShapes
 - SectionDisplacement
 - AnalysisResults

Praveen Kumar

PRINCIPAL
PRAVEEN
INSTITUTE OF SCIENCE & TECHNOLOGY
Kandlakota, 500 005.



- MemberStresses
 - ElementForces/Stresses
- f. ViewingResults
 - g. OutputFile
 - h. Post ProcessingMode

Chapter 9: Analysis Case Studies / Workshops

- q. RCCDesign&Analysis(BeamsandColumns)
- r. SteelDesign&Analysis(FramesandTrusses)
- s. MiscellaneousAnalysis
- t. Practice examples forStudent

Praveen Kumar

PRINCIPAL
MAHAVEER
INSTITUTE OF ENGINEERING & TECHNOLOGY
HARIDWAR, INDIA - 249 005.

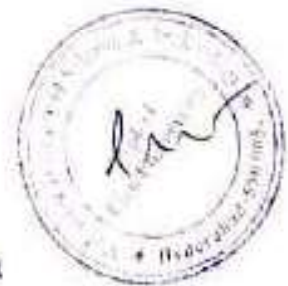

Vysapuri, Bandlaguda Post:Kothavari,
Hyderabad-500 005, Telangana INDIA
Tel: 040-64596979,20020773, Fax: 040-24455003
E-mail: principal.mahaveer@gmail.com
Website: www.mist.ac.in,

MAHAVEER

INSTITUTE OF SCIENCE & TECHNOLOGY
Approved by AICTE, Affiliated to JNTUH,Hyd.



Department of Civil Engineering
STAAD.Pro/IS Technical Training student attendance list 2020-21

SL.NO.	ROLL NO.	NAME OF THE STUDENT	YEAR
1	17E31A0101	ANNALDAS JANAKI	IV
2	17E31A0102	ARSHI FIRDAUSH	IV
3	17E31A0103	B SOHAN LAL	IV
4	17E31A0105	BHUKYA RAIU	IV
5	17E31A0106	BHUKYA RAVIKUMAR	IV
6	17E31A0107	BOLLAM VIJAY KUMAR	IV
7	17E31A0108	CHELUMALLA VIKAS REDDY	IV
8	17E31A0109	CHENNAKESHI MANIKANTA MUDHIRAJ	IV
9	17E31A0110	D TEJA	IV
10	17E31A0113	DEVALLA SMARANI	IV
11	17E31A0116	HALAYATHI HARI KRISHNA	IV
12	17E31A0121	M A GHANIUDDIN	IV
13	17E31A0122	MADDELA ARUN KUMAR	IV
14	17E31A0125	MOHAMMED MUQTAR PATEL	IV
15	17E31A0128	MOHD MAJEED UDDIN	IV
16	17E31A0135	PAKALA SAI PRASAD	IV
17	17E31A0138	SHARAVATHI SREEDHER	IV
18	17E31A0139	SHIVARATRI KUMAR	IV
19	17E31A0140	SIDDAMSETTI AVINASH	IV
20	17E31A0141	SK REHMATHBABA	IV
21	17E31A0142	SUNKARA HARSHAVARDHAN	IV
22	17E31A0143	TURUKA PAVANI	IV
23	17E31A0144	YATHAM SAI YASHASWINI	IV
24	18E35A0101	ADNAN ABDUL WASE	IV
25	18E35A0102	BADALA VARA PRASAD	IV
26	18E35A0105	DONTHARADONNA KIRAN KUMAR	IV
27	18E35A0106	KOLLA KRANTHI KUMAR	IV
28	18E35A0107	MANKA TUSHAL YADAV	IV
29	18E35A0108	MELIUGU BOBHITHI	IV
30	18E35A0109	MUTUKUNTLA MOUNIKA	IV
31	18E35A0110	POCHAGARI ALOK	IV
32	18E35A0111	P DELIPA SREE	IV
33	18E35A0112	P RAGHAVENDAR	IV
34	18E35A0113	SANDANI TEJASWINI	IV
35	18E35A0114	SUPRETHALLI VENUGOPAL	IV
36	17H11A0107	ABUBAKAR	IV
37	17H11A0118	MOHAMMED ACHRAF	IV
38	17H11A0119	MOHAMMED ASIM AFINAN	IV
39	19E38A0101	GOTTIMUKKALA VENKATA ABHIGYAN SHARMA	IV

Principal
PRINCIPAL
MAHAVEER
INSTITUTE OF SCIENCE & TECHNOLOGY
Bandlaguda, Hyderabad



MAHAVEER INSTITUTE OF SCIENCE & TECHNOLOGY, HYDERABAD
CIVIL ENGINEERING STUDENTS ATTENDANCE

B.TECH IV YEAR II SEM 2020-2021 BATCH / Date - 13/01/2020 - 24/01/2021

S.No	Hall Ticket No	Name of the Candidate	1	2	3	4	5	6	7	8	9	10
1	17E31A0101	ANNALDAS JANAKI	A	P	P	P	P	P	P	P	P	P
2	17E31A0102	ARSHI FIRDAUSH	P	A	P	P	P	P	P	P	P	P
3	17E31A0103	B SOHAN LAL	P	P	A	P	P	P	P	P	P	P
4	17E31A0105	BHUKYA RAJU	P	P	P	A	P	P	P	P	P	P
5	17E31A0106	BHUKYA RAVIKUMAR	A	P	P	P	P	P	P	P	P	P
6	17E31A0107	BOLLAM VIJAY KUMAR	P	P	A	P	P	P	P	P	P	P
7	17E31A0108	CHELUMALLA VIKAS REDDY	P	P	P	P	P	A	P	P	P	P
8	17E31A0109	CHENNAKESHI MANKANTA MUDHIRAJ	P	P	P	P	P	P	A	P	P	P
9	17E31A0110	D TEJA	P	P	P	P	P	P	P	P	P	A
10	17E31A0113	DEVALLA SMARANI	P	A	P	P	P	P	P	P	P	P
11	17E31A0116	HALAVATHI HARJ KRISHNA	P	P	P	P	A	P	P	P	P	P
12	17E31A0121	M A GHANIUDDIN	P	P	P	P	P	P	P	P	P	A



(Handwritten Signature)

PRINCIPAL
M AHAVEER
 INSTITUTE OF SCIENCE & TECHNOLOGY
 Bandlaguda, Hyd-500 045.

25	18E35A0102	BADALA VARA PRASAD	A	P	P	P	P	P	P	P	P	P	P	P	P	P	P	P
26	18E35A0105	DONTHARABOI NA KIRAN KUMAR	P	P	P	A	P	P	P	P	P	P	P	P	P	P	P	P
27	18E35A0106	KOLLA KRANTHI KUMAR	P	P	P	P	P	P	P	P	A	P	P	P	P	P	P	P
28	18E35A0107	MANNA TUSHAL YADAV	P	A	P	P	P	P	P	P	P	P	P	P	P	P	P	P
29	18E35A0108	MERUGU ROHITH	P	P	P	P	P	P	P	A	P	P	P	P	P	P	P	P
30	18E35A0109	MULLUKUNTILA MOUNIKA	P	P	A	P	P	P	P	P	P	P	P	P	P	P	P	P
31	18E35A0110	POCHAGARI ALOK	P	P	P	P	P	P	P	P	P	P	P	A	P	P	P	P
32	18E35A0111	P DEEPA SREE	P	P	P	P	P	P	P	P	P	P	P	P	P	P	P	A
33	18E35A0112	RAGHAVENDA R	A	P	P	P	P	P	P	P	P	P	P	P	P	P	P	P
34	18E35A0113	SANDADI TEJASWINI	P	P	P	P	P	P	P	P	P	P	P	P	P	A	P	P



Principal

PRINCIPAL
M. J. AVEER

INSTITUTE OF ENGINEERING & TECHNOLOGY
Gandhinagar, Hyderabad-500 005.

35	18E35A0114	UPUTHALLI VENUGOPAL	A	P	P	P	P	P	P	P	P	P	P	P	P	P	P	P
36	17H11A0102	ABUBAKAR	P	P	P	P	P	P	P	P	P	P	P	P	P	P	P	P
37	17H11A0118	MOHAMMED ALTHAF	A	P	P	P	P	P	P	P	P	P	P	P	P	P	P	P
38	17H11A0119	MOHAMMED ASIM ADNAN	P	P	P	P	P	P	P	P	P	P	P	A	P	P	P	P
39	19E38A0101	GOTTIMUKKAL A VENKATA ABHIGYAN SHARMA	P	P	P	P	P	P	P	P	P	P	P	P	P	P	P	P

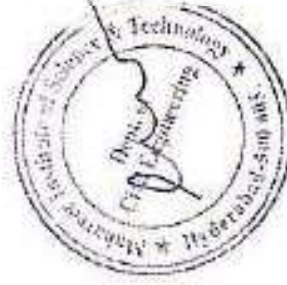

 PRINCIPAL
 M.A. H. AVEER
 INSTITUTE OF SCIENCE & TECHNOLOGY
 Bandlaguda, Hyd-500 005.



Technical Training Exam on STAAD Pro V8 Software
(A.Y-2020-21)

2x10=20 Marks

Answer All the Questions

- d. Analyse the given beam using Staad Pro Cross section of Beam 200mmx400mm Grade of Concrete M 25 Grade of Steel Fe 415. Plot SFD,BMD and deflected profile.

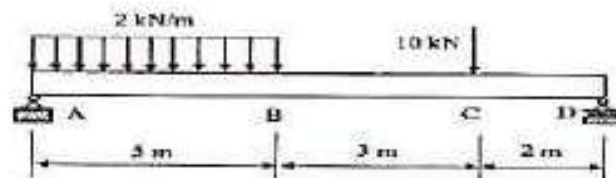

- b. Analyse the given beam using Staad Pro Cross section of Beam 200mmx400mm Grade of Concrete M 30 Grade of Steel Fe 415. Plot SFD,BMD and deflected profile.

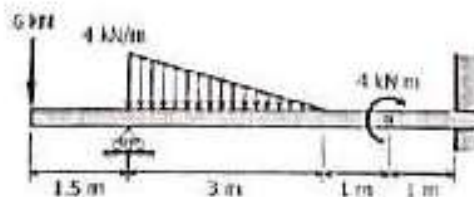

Principal
PRINCIPAL
VEER
TECHNOLOGY
500 005.

- f. Analyse the given beam using Staad Pro Cross section of Beam 200mmx400mm Grade of Concrete M 25 Grade of Steel Fe 415. Plot SFD,BMD and deflected profile.

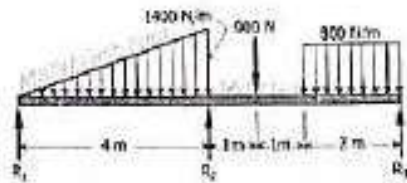

B. Srinivas
PRINCIPAL
MAHAVEER
INSTITUTE OF SCIENCE & TECHNOLOGY
Bansal Road, Hyd-500 005

Vysapuri, Bandlaguda Post:Koshavgirl,
Hyderabad-500 095, Telangana INDIA
Tel: 040-54596379,20020773, Fax: 040-24455003
E-mail: principalmahaveer@gmail.com,
Website: www.mist.ac.in,

MAHAVEER

INSTITUTE OF SCIENCE & TECHNOLOGY
Approved by AICTE, Affiliated to JNTUH,Hyd.



Department of Civil Engineering					
STAAD.ProVi8 Technical Training student attendance list 2020-21					
SNO	Roll No	Name of the student	YEAR	MARKS	PASS/FAIL
1	17E31A0101	ANNALDAS JANAKI	IV	16	PASS
2	17E31A0102	ARSHI FIRDAUSH	IV	16	PASS
3	17E31A0103	B SOHAN LAL	IV	12	PASS
4	17E31A0105	BHUKYA RAJU	IV	12	PASS
5	17E31A0106	BHUKYA RAVIKUMAR	IV	16	PASS
6	17E31A0107	BOLLAM VIJAY KUMAR	IV	16	PASS
7	17E31A0108	CHELUMALLA VIKAS REDDY	IV	16	PASS
8	17E31A0109	CHENNAKESHI MANIKANTA MUDHIRAJ	IV	16	PASS
9	17E31A0110	D TEJA	IV	16	PASS
10	17E31A0113	DEVALLA SMARANI	IV	16	PASS
11	17E31A0116	HALAVATH HARI KRISHNA	IV	16	PASS
12	17E31A0121	M A GHANIUDDIN	IV	16	PASS
13	17E31A0122	MADDELA ARUN KUMAR	IV	16	PASS
14	17E31A0125	MOHAMMED MUQTAR PATEL	IV	16	PASS
15	17E31A0128	MOHD MAJEED UDDIN	IV	16	PASS
16	17E31A0135	PAKALA SAI PRASAD	IV	16	PASS
17	17E31A0138	SHARAVATH SREEDHER	IV	16	PASS
18	17E31A0139	SHIVARATRIN KUMAR	IV	16	PASS
19	17E31A0140	SIDDAMSETTI AVINASH	IV	15	PASS
20	17E31A0141	SK REHMATHBABA	IV	16	PASS
21	17E31A0142	SUNKARA HARSHAVARDHAN	IV	16	PASS
22	17E31A0143	TURUKA PAVANI	IV	15	PASS
23	17E31A0144	YATHAM SAI YASHASWINI	IV	16	PASS
24	18E35A0101	ADNAN ABDUL WASE	IV	14	PASS
25	18E35A0102	BADALA VARA PRASAD	IV	15	PASS
26	18E35A0105	DONTARABOINA KIRAN KUMAR	IV	15	PASS
27	18E35A0106	KOLLA KRANTHI KUMAR	IV	16	PASS
28	18E35A0107	MANKA TUSHAL YADAV	IV	14	PASS
29	18E35A0108	MERUGU ROHITH	IV	16	PASS
30	18E35A0109	MULLUKUNTLA MOUNIKA	IV	15	PASS
31	18E35A0110	POCHAGARI ALOK	IV	14	PASS
32	18E35A0111	P DEEPA SREE	IV	18	PASS
33	18E35A0112	P RAGHAVENDAR	IV	15	PASS
34	18E35A0113	SANDADI TEJASWINI	IV	16	PASS
35	18E35A0114	UPUTHALLI VENUGOPAL	IV	15	PASS
36	17H11A0102	ABUBAKAR	IV	16	PASS
37	17H11A0118	MOHAMMED ALTHAF	IV	16	PASS
38	17H11A0119	MOHAMMED ASIM ADNAN	IV	15	PASS
39	19E38A0101	GOTTIMUKKALA VENKATA ABHIGYAN SHARMA	IV	16	PASS

PRINCIPAL
MAHAVEER

INSTR

TECHNOLOGY

Vysapuri, Bandlaguda Post: Keshavgiri,
Hyderabad-500 005, Telangana INDIA
Tel: 040-84596979, 20020773, Fax: 040-24455003
E-mail: principal.mahaveer@gmail.com,
Website: www.mist.ac.in,

MAHAVEER
INSTITUTE OF SCIENCE & TECHNOLOGY
Approved by AICTE, Affiliated to JNTUH, Hyd



STAAD PRO V8 COURSE

Summary

Department of Civil Engineering

- Model Generation and Editing
- Assigning loads
- Creating Load Combinations
- Concrete Design
- Seismology
- Steel Design
- Foundation Designs
- Report Generation and Plotting



Praveen Kumar
PRINCIPAL
MAHAVEER
INSTITUTE OF SCIENCE & TECHNOLOGY
Bandlaguda, Hyd-500 005

Vysapuri, Bandlaguda Post:Keshavgiri,
Hyderabad-500 005, Telangana INDIA
Tel: 040-64596979,20020773, Fax: 040-24455003
E-mail: principal.mahaveer@gmail.com,
Website: www.mist.ac.in,

MAHAVEER
INSTITUTE OF SCIENCE & TECHNOLOGY
Approved by AICTE, Affiliated to JNTUH,Hyd.



CERTIFICATE OF COURSE COMPLETION

This certificate is presented to _____ of
MIST,who has successfully completed technical training course on
“STAAD PROVi8” held from _____ to _____ and
found the student performance to be excellent.



ESTD : 2001

CH. SWETHAMBER

HOD

Civil department



PRINCIPAL
MAHAVEER
INSTITUTE OF SCIENCE & TECHNOLOGY
Bandlaguda, Hyd-500 005.

Santraguda Post Keshavnagar

MAHAVEER



Hyderabad-500 005, TELANGANA, INDIA

Tel: 040-64556975, 0978380092 Fax: 040-24455993

E-mail: e2hod.ene@gmail.com

Website: www.mahaveer.ac.in

Approved by AICTE, Affiliated to JNTU-Hydr

DEPARTMENT OF ELECTRICAL & ELECTRONICS

Date: 11.11.2020

To,

The Principal,

Mahaveer

Hyderabad

Sub-Proposal for Add on course-Reg.

Respected Sir,

We are going to conduct two weeks workshop on **AUTO CAD**. We require your approval to go ahead for further processing and hope to get an opportunity to serve you the best. With thanks and regards.

Principal

MAHAVEER

INSTITUTE OF SCIENCE & TECHNOLOGY
Santraguda, Hyd-500 005

HOD EEE

Dr. K. Srinivas
Department of Electrical & Electronics Engineering
Mahaveer Institute of Science & Technology
Santraguda, Keshavnagar, Hyderabad-500 005



Hyderabad-500 005, TELANGANA INDIA

Tel: 040-64596979,8978380692 Fax: 040-24455003

E-mail: e3hod.eee@gmail.com

Website: www.mist.ac.in

Approved by AICTE. Affiliated to JNTUH Hyd

DEPARTMENT OF ELECTRICAL & ELECTRONICS

Date: 21-12-2020

CIRCULAR

Technical Trainings for III B Tech students are starting from 28-12-2020 onwards. All HODs and placements coordinators have to manage the trainings and ensure 95% attendance all through the sessions.

All mentors need to send the compiled feedback report to HOD at e3hod.eee@gmail.com daily. Mentors are advised to take care of PNR (Students not participating in training).

Agenda: **AutoCAD**

Design & Development of Curriculum for Add on Courses Faculty Names 1.Dr M Rajendar reddy
2.P.V.V. SATYANARAYANA

PRINCIPAL
MAHAVEER
INSTITUTE OF SCIENCE & TECHNOLOGY
Bandlaguda, Hyd-500 005.

HOD-EEE

DR. RAJENDAR REDDY, M.TECH.,
Professor & Head
Dept of Electrical & Electronics Engg
Institute of Science & Technology
Vysapuri, Bandlaguda, Keshavpuram
Hyderabad - 500 005



DEPARTMENT OF ELECTRICAL & ELECTRONICS

SYLLABUS FOR AutoCAD

SNO	TOPIC COVERED	DURATION
1	Introduction	3
2	Organize the information on layers	3
3	Use the blocks , attributes, external reference to drawing	3
4	Understand the concept of 3D	3
5	Create 3-dimensional entities	3
6	Editing in 3-dimension	6
7	Editing in 3-dimension solids	3
8	Application of layers	3
9	Application of blocks	3

M. Rajendar Reddy
HOD-EEE

M. Rajendar Reddy
Dr. M. RAJENDAR REDDY, M.Tech.,
Profes. - 511024
Dept. of Electrical & Electronic Engg.
Mahaveer Institute of Science & Technology
Vysapuri, Bandlaguda, Keshavnagar,
Hyderabad - 500 005.

K. Sankar
K. Sankar
11/11/2023, 11:02:30 AM

**DEPARTMENT OF ELECTRICAL & ELECTRONICS****LIST OF REGISTERED STUDENTS FOR AutoCAD**

SNO	HALL TICKET NO	NAME OF THE STUDENT
1	18E31A0201	A CHANDANA YADAV
2	18E31A0202	ELIMELA SHIVANI
3	18E31A0203	ELIABOYINI NAVEEN GOUD
4	18E31A0204	GAMULA LOKESH KUMAR
5	18E31A0206	KATTOJI SATYA SAI
6	18E31A0208	KOTTE HAVILAH
7	18E31A0209	MA QUAVEE ZAID
8	18E31A0210	MALOTH PAVANKUMAR
9	18E31A0211	MAITEE AAKANKSHA
10	18E31A0212	MUSKAN PRIYA
11	18E31A0213	PADAMATI KEERTHI
12	18E31A0214	PADITHAPU SHASHANK
13	18E31A0215	POTHURAJU PRASHANTH KUMAR
14	18E31A0216	RAJAN SHARMA
15	18E31A0217	S VISHNU VARDHAN
16	18E31A0219	SHAIK MUSHTAQ AHMED
17	18E31A0220	SHAIK RAFI
18	18E31A0221	VAISHALI CHAVAN
19	19E35A0201	BHUKYA JAGADEESHWAR NAIK
20	19E35A0202	CHAKALI BHARATH KUMAR
21	19E35A0203	CHAKALI UMESH CHANDRA
22	19E35A0204	DAMA RANI
23	19E35A0205	GONDRA AJAY
24	19E35A0206	GURRAMYAHESH KUMAR
25	19E35A0207	K. SURESH KUMAR
26	19E35A0208	KOTTONSAPATHI
27	19E35A0209	KUNDIARAPU MEENDE
28	19E35A0210	MOODAVATHI SATHISH
29	19E35A0211	R SRINIVASA KRISHNAN
30	18D91A0209	J MADHAN
31	17E31A0228	V SWATHI

PRINCIPAL
MAHAVEER
 INSTITUTE OF SCIENCE & TECHNOLOGY
 Bandlaguda, Hyd-500 005.



DEPARTMENT OF ELECTRICAL & ELECTRONICS

Autocad QUESTION PAPER

Duration: 120 Minutes

4 X 5 = 20 Marks

Answer the following all questions. Each question carries 5 marks.

1. What are the fields where you see maximum use of Autocad?
2. What are the file formats used in design?
3. How can you create a user interface in Autocad?
4. How can you remove the empty layers from drawing?

[Handwritten signature in green ink]
T. S. K. Reddy
HOD-EEE
Department of Electrical & Electronics Engineering
Mahaveer Institute of Technology
Vysapuri, Bandlaguda, Keshavnagar,
Hyderabad - 500 005.

[Handwritten signature in black ink]
HOD-EEE

A. RAJENDAR REDDY, M.Tech
Professor & Head
Dept. of Electrical & Electronics Engineering
Mahaveer Institute of Science & Technology
Vysapuri, Bandlaguda, Keshavnagar,
Hyderabad - 500 005.

**DEPARTMENT OF ELECTRICAL & ELECTRONICS****RESULT SHEET FOR Autocad**

SNO	HALL TICKET NO	NAME OF THE STUDENT	MARKS (20)	RESULT
1	18E31A0201	A CHANDANA YADAV	20	PASS
2	18E31A0202	ELEMELA SHIVANI	19	PASS
3	18E31A0203	ETTABOYINI NAVLEN GOUD	20	PASS
4	18E31A0204	GAJULA LOKESH KUMAR	18	PASS
5	18E31A0206	KATTOJISATYA SAI	20	PASS
6	18E31A0208	KOTTE HAVILAH	20	PASS
7	18E31A0209	MA QUAVEE ZAID	16	PASS
8	18E31A0210	MALOTH PAVANKUMAR	20	PASS
9	18E31A0211	MATEH AAKANKSHA	20	PASS
10	18E31A0212	MUSKAN PRIYA	17	PASS
11	18E31A0213	PADAMATI KEERTHI	20	PASS
12	18E31A0214	PADITHAPU SHASHANK	20	PASS
13	18E31A0215	POTHURAJU PRASHANTH KUMAR	16	PASS
14	18E31A0216	RAJAN SHARMA	20	PASS
15	18E31A0217	S VISHNUVARDHAN	20	PASS
16	18E31A0219	SHAIK MUSHTAQ AHMED	18	PASS
17	18E31A0220	SHAIK RAFI	20	PASS
18	18E31A0221	VAISHALI CHAVAN	19	PASS
19	19E35A0201	BHUKYA JAGADEESHWAR NAIK	20	PASS
20	19E35A0202	CHAKALI BHARATH KUMAR	18	PASS
21	19E35A0203	CHAKALI CHANDEY DEVI	20	PASS
22	19E35A0204	DAMIRANI	20	PASS
23	19E35A0205	GONDRA ALAY	16	PASS
24	19E35A0206	GIRRYMI SIVESH KUMAR	20	PASS
25	19E35A0207	KANKIPATI PRASHANTH	20	PASS
26	19E35A0208	KONDA SAMPATH	20	PASS
27	19E35A0209	KUNDHARAPU MANOJ	18	PASS
28	19E35A0210	MOODAVATH SANTHOSH	19	PASS
29	19E35A0211	R SRINIVASA KRISHNAN	20	PASS
30	18D91A0209	J MADHAN	18	PASS
31	17E31A0228	V SWATHI	18	PASS

No. of students Registered:31

No. of students Passed:31

No. of students failed:NIL

MAHAVEER

Dr. V. Lakshmi Reddy
 Prof. & Head
 Dept. of Electrical & Electronics
 Mahaveer Institute of Science & Technology
 Vysapuri, Bandlaguda, Keshavgiri
 Hyderabad - 500 005

MAHAVEEER INSTITUTE OF SCIENCE ANDTECHN



ESTD : 2001

(Affiliated to JNTUH, Hyderabad and Approved by AICTE, NewDelhi)
Vyasapuri, Bandlaguda, Post: Keshavagiri, Hyderabad- 500005

organized by

Department of Electrical and Electronics Engineering

CERTIFICATE

This is certify that Muskan Priya bearing Hall Ticket No 18E31A02
B.Tech Third Year has Participated in AUTOCAD Programming T
Program From 28-12-2020 to 11-01-2021 organized by Departmen
Electrical and Electronics Engineering.

Dr.M.Sudhakaran

HOD

P.V.V.Satyanarayana

MIST

PRINCIP

Dr.B.Nage

About the college:

About the Department:

Mission:

Objectives of the workshop:

Chief Patrons:

Patron:

Academic Advisor:

Topics:

- Use of PLC Symbols.
- Usage of Schematics of single wires & Commands.
- Manage project paths & file paths in AutoCAD Electrical

Certificate will be issued for active participants

Convenor:

Program Coordinators:

Resource Person:

Who all can participate

INSTITUTE OF SCIENCE & TECHNOLOGY

Approved by AICTE, Affiliated to JNTU H. Hyderabad
erst. Bhanu Prasad Rao, Keshavnagar, District, Warangal, TS 506004

Two Weeks certificate course on

AUTOCAD

AUTOCAD ELECTRICAL

December 28th to 20th, 2020
19-January 2021
Timings: 10:00am to 2:00pm



DEPARTMENT OF ELECTRICAL ENGINEERING

Vysapuri, Bandlaguda Post:Keshavgirl,

MAHAVEER



Hyderabad-500 005, TELANGANA INDIA

Tel: 040-64596979,8978380692,Fax: 040-24455003

E-mail: e3hod.eee@gmail.com

Website: www.mistac.in

INSTITUTE OF SCIENCE & TECHNOLOGY

Approved by AICTE, Affiliated to JNTUH,Hyd.

DEPARTMENT OF ELECTRICAL & ELECTRONICS

Date: 1-06-2021

To
The Principal,
Mist,
Hyderabad.

Sub:Proposal for Add on course-Reg.

Respected sir,

We are going to conduct two weeks workshop on **Mat CAD Programming**. We require your approval to go head for further proceeding and hope to get an opportunity to serve you the best.

With thanks and regards

PRINCIPAL
MAHAVEER
INSTITUTE OF SCIENCE & TECHNOLOGY
Bandlaguda, Hyd-500 005.

HOD-EEE

DR. RAJENDRA REDDY, M.Sc.
Sr. Lecturer & Head
Dept. of Electrical & Electronics Engg.
Mahaveer Institute of Science & Technology
Vysapuri, Bandlaguda, Keshavgirl,
Hyderabad - 500 005.

Vysapuri, Bandlaguda Post:Keshavgiri,

MAHAVEER



Hyderabad-500 005, TELANGANA INDIA

Tel: 040-64596979, 8978380692, Fax: 040-24455003

E-mail: e3hod.eee@gmail.com,

Website: www.mist.ac.in,

Approved by AICTE, Affiliated to JNTUH,Hyd.

DEPARTMENT OF ELECTRICAL & ELECTRONICS

Date: 01-06-2021

CIRCULAR

Technical Trainings for II B. Tech students are starting from **08-06-2021** onwards. All HODs and placements coordinators have to manage the trainings and ensure 95% attendance all through the sessions.

All mentors need to send the compiled feedback report to HOD at e3hod.eee@gmail.com daily. Mentors are advised to take care of PNR (Students not participating in training).

Agenda: **MATCAD Programming**

Design & Development of Curriculum for Add on Courses Faculty Names 1. Dr M Rajendar reddy
Sudakaran

2. Dr M SUDAKARAN

PRINCIPAL
MAHAVEER
INSTITUTE OF SCIENCE & TECHNOLOGY
Bandlaguda, Hyd-500 005.

HOD-EEE

M. RAJENDAR REDDY, M.Tech., Ph.D.
Professor & Head
Dept. of Electrical & Electronics Engg
Mahaveer Institute of Science & Technology
Vysapuri, Bandlaguda, Keshavgiri,
Hyderabad - 500 005.

Vysapuri, Bandlaguda Post:Keshavgi, Hyderabad-500 005, TELANGANA INDIA

MAHAVEER



Hyderabad-500 005, TELANGANA INDIA

Tel: 040-64596979,6978380692.Fax: 040-24455003

E-mail: e3hod.eee@gmail.com.

Website: www.mist.ac.in.

Approved by AICTE, Affiliated to JNTUH,Hyd.

DEPARTMENT OF ELECTRICAL & ELECTRONICS

SYLLABUS FOR MATLAB Programming

SNO	TOPIC COVERED	DURATION
1	Introduction	3
2	numan analysis	3
3	model equation	3
4	Dafalias Model	3
5	Manzari Model	3
6	Equivalent Impedance and Conductance	3
7	Transfer Function Models	3
8	Signal Propagation Delay	3
9	Filter Design	3
10	Component Trade-off Analysis	3
11	AC/DC Circuit Analysis	3
12	Power Dissipation	3
13	Transformer Sizing	3

PRINCIPAL
MAHAVEER
INSTITUTE OF SCIENCE & TECHNOLOGY
Bandlaguda, Hyd-500 005.

HOD-EEE

R Reddy
Dr. M. RAJENDAR REDDY, M.Tech., Ph.D.
Professor & Head
Dept. of Electrical & Electronics Engg
Mahaveer Institute of Science & Technology
Vysapuri, Bandlaguda, Keshavgi,
Hyderabad - 500 005.

Vysapuri, Bandlaguda Post:Keshavgi,

MAHAVEER



Hyderabad-500 005, TELANGANA INDIA

Tel: 040-64596979,8978380692,Fax: 040-24455003

E-mail: e3hod.eee@gmail.com

Website: www.mist.ac.in

Approved by AICTE, Affiliated to JNTUH,Hyd.

DEPARTMENT OF ELECTRICAL & ELECTRONICS

LIST OF REGISTERED STUDENTS FOR MATCAD Programming

SNO	HALL TICKET NO	NAME OF THE STUDENT
1	19E31A0201	AARE BHARGAV KUMAR
2	19E31A0202	AKULA RAKESH
3	19E31A0204	BATHULA NAVEEN
4	19E31A0205	BHUKYA PRAVEEN KUMAR
5	19E31A0207	GANDHAM DEEPAK
6	19E31A0208	GANDRA DEEKSHITH RAO
7	19E31A0209	GUGULOTH JASWANTH NAIK
8	19E31A0210	GUGULOTHU PRAVEENA
9	19E31A0211	GUNUGANTI SPOORTHI
10	19E31A0212	KANKANALA SAIKUMAR
11	19E31A0213	KOWTIKWAR BAJRANG
12	19E31A0214	LINGAMPALLY MANOJ RAO
13	19E31A0215	MARINE NAVEEN
14	19E31A0216	MOGILI MANJULA
15	19E31A0217	MORAM DANUSH REDDY
16	19E31A0218	MUKKU GANESH REDDY
17	19E31A0219	NALLA RAHUL
18	19E31A0220	T DEEPTHI
19	19E31A0221	UPPANUTHULA SANJAY
20	19E31A0222	VEMUNURI RAJU
21	19E31A0223	VENNAMPPELLI SANDEEP
22	18E31A0218	S DEEPAK KUMAR
23	18E31A0205	HATKAR JEEVAN
24	16E31A0216	MAVILLA RAGHAVENDER GOUD
25	20E35A0201	VARAPATI SATHISH
26	20E35A0202	AVANDESH NAINATH
27	20E35A0203	EMMADI KAVERI
28	20E35A0204	G BHARGHAVA REDDY
29	20E35A0205	G SHIVANI
30	20E35A0206	GANDHAM SAI KIRAN
31	20E35A0207	KAILASAPU PREM CHANDU
32	20E35A0208	KODIGANTI PRABHAS
33	20E35A0209	PATHAKUNTA THARUN
34	20E35A0210	SUNEHRA KUNAL PRASAD
35	20E35A0211	Y VISHAL

MAHAVEER
DEPARTMENT OF SCIENCE & TECHNOLOGY
Bandlaguda, Hyderabad - 500 005

Vysapuri, Bandlaguda Post:Keshavgi,

MAHAVEER



Hyderabad-500 005, TELANGANA INDIA

Tel: 040-64596979,8978380692,Fax: 040-24455003

E-mail: e3hod.eee@gmail.com,

Website: www.mist.ac.in,

Approved by AICTE, Affiliated to JNTUH,Hyd.

DEPARTMENT OF ELECTRICAL & ELECTRONICS

MATCAD Programming QUESTION PAPER

Duration: 120 Minutes

10 X 2 = 20 Marks

Answer the following all questions. Each question carries 2 marks.

1. How to calculate particle size using raman analysis?
2. How check a model equation ?
3. How Dafalias and Manzari Model works in multiaxial space?
4. How can I model a graded design of optical filter?

HOD-EEE

L. VENKATAR REDDY, M.Tech.
Professor & Head
Dept. of Electrical & Electronics Engg
Mahaveer Institute of Science & Technol
Vysapuri, Bandlaguda, Keshavgi,
Hyderabad - 500 005.



PRINCIPAL
MAHAVEER
INSTITUTE OF SCIENCE & TECHNOLOGY
Bandlaguda, Hyd-500 005.

Vysapuri, Bandlaguda Post:Keshavgiri,

MAHAVEER



Hyderabad-500 005, TELANGANA INDIA

Tel: 040-64596979,8978380692.Fax: 040-24455003

E-mail: e3hod.eee@gmail.com,

Website: www.mist.ac.in,

Approved by AICTE, Affiliated to JNTUH,Hyd.

DEPARTMENT OF ELECTRICAL & ELECTRONICS

RESULT SHEET FOR MATCAD Programming REGISTERED STUDENTS

SNO	HALL TICKET NO	NAME OF THE STUDENT	MARKS (20)	RESULT
1	19E31A0201	AARE BHARGAV KUMAR	20	PASS
2	19E31A0202	AKULA RAKESH	19	PASS
3	19E31A0204	BATHULA NAVEEN	20	PASS
4	19E31A0205	BHUKYA PRAVEEN KUMAR	18	PASS
5	19E31A0207	GANDHAM DFEPAK	20	PASS
6	19E31A0208	GANDRA DEEKSHITH RAO	20	PASS
7	19E31A0209	GUGULOTH JASWANTH NAIK	16	PASS
8	19E31A0210	GUGULOTHU PRAVEENA	20	PASS
9	19E31A0211	GUNUGANTI SPOORTHI	20	PASS
10	19E31A0212	KANKANALA SAIKUMAR	17	PASS
11	19E31A0213	KOWTIKWAR BAJRANG	20	PASS
12	19E31A0214	LINGAMPALLY MANOJ RAO	20	PASS
13	19E31A0215	MARINE NAVEEN	16	PASS
14	19E31A0216	MOGLI MANJULA	20	PASS
15	19E31A0217	MORAM DANUSH REDDY	20	PASS
16	19E31A0218	MUKKU GANESH REDDY	18	PASS
17	19E31A0219	NALLA RAHUL	20	PASS
18	19E31A0220	T DEEPTHI	19	PASS
19	19E31A0221	UPPANTHULA SANJAY	20	PASS
20	19E31A0222	VEMUNURI RAJU	18	PASS
21	19E31A0223	VENNAMPPELLI SANDEEP	20	PASS
22	18E31A0218	S DEEPAK KUMAR	19	PASS
23	18E31A0205	HATKAR JEEVAN	20	PASS
24	16E31A0216	MAVILLA RAGHAVENDER GOUD	18	PASS
25	20E35A0201	AKARAPU SATHISH	20	PASS
26	20E35A0202	AVINDI SIVANATHI	20	PASS
27	20E35A0203	EMMADI KAVERI	16	PASS
28	20E35A0204	G BHARGAVA REDDY	20	PASS
29	20E35A0205	G SHIVANI	20	PASS
30	20E35A0206	GANDHAM SAI KIRAN	17	PASS
31	20E35A0207	KAILASAPU PREM CHANDU	20	PASS
32	20E35A0208	KODIGANTI PRABHAS	20	PASS
33	20E35A0209	PATHAKUNTA THARUN	16	PASS
34	20E35A0210	SUNEHRA KUNAL PRASAD	20	PASS
35	20E35A0211	Y VISHAL	20	PASS

No. of students Registered: 35

No. of students Passed:35

No. of students failed:NIL.

PRINCIPAL
MAHAVEER
INSTITUTE OF
ELECTRICAL & ELECTRONICS
TECHNOLOGY
Bandlaguda, Hyd-500 005.

PROF. RAJENDAR REDDY, M.Tech., Ph.D.
Professor & Head
Dept. of Electrical & Electronics Engg
Mahaveer Institute of Science & Technology
Vysapuri, Bandlaguda, Keshavgiri,
Hyderabad - 500 005.

Vysapuri, Bandlaguda Post:Keshavgiri,

MAHAVEER



Hyderabad-500 005, TELANGANA INDIA

Tel: 040-64596979,8978380692 Fax: 040-24455003

E-mail: e3hod_eee@gmail.com

Website: www.mist.ac.in,

Approved by AICTE. Affiliated to JNTUH,Hyd.

DEPARTMENT OF ELECTRICAL & ELECTRONICS

SUMMARY REPORT OF MATCAD Programming

Mathcad is a product of MathSoft inc. The Mathcad can help us to calculate, graph, and communicate technical ideas. It lets us work with mathematical expressions using standard math notation - but with the added ability to recalculate, view, present, and publish with ease, even to the Web.

COORDINATOR

Copy to:

1. Department Notice Board
2. Principal for Information
3. Committee Members (Academic)



PRINCIPAL
MAHAVEER
INSTITUTE OF SCIENCE & TECHNOLOGY
Bandlaguda, Hyd-500 005.

MAHAVEER

INSTITUTE OF SCIENCE & TECHNOLOGY
Approved by AICTE, Affiliated to JNTU/Hydr.



A Two week Certificate course

On

“MATCAD PROGRAMMING”



Resource Person:

Dr.M.Sudhakaram

Scheduled From 8th June to

26th June-2021

Timings: 10:00am to 1:00pm

Organized By
Department of

EEE Engineering

Who can participate

All Engineering Faculty, Research Scholars and
Industrial Persons

(E-certificates will be issued to all
the participants, whose submitted back forms)

Organized Committee:

Chief Patrons:

Smt.S.Jayalaxmi, Chairman

Sri S.Surender Reddy, Secretary

Sri S.Dhananjay Reddy, Joint Secretary

Patrons:

Dr.K.S.S.N.Reddy, Principal

Academic Advisor:

Dr.H.S.N.Murthy, Director

Convener:

Dr.M.Rajender

Reddy Professor & HOD, Dept. of EEE

Engineering

Co-Conveners: (contact for

details) 1. Mr.

P.V.V.Sarjumarayana, Professor

2. Mrs. N. Saraswathi- Assistant Professor

Program Coordinators:

1. Mr. G.Pran Kumar Reddy- Assistant Professor

2. Mr. B. Satish - Assistant Professor

3. Mrs. G. Jyothi- Assistant Professor

4. Mr. A. Mahesh Kumar- Assistant Professor

5. Mrs. K. S. Bhargavi- Assistant Professor

Contact Details:

Feel free to asky our queries either by E-

Mail: e3hodgee@gmail.com (or) Contact -

9966411762, 9989840617

About the College:

Mahaveer Institute of Science & Technology (MIST)

established in the year 2001 by

Mahaveer Educational Society, MIST is offering 81 UG pr-

ograms,

6 PG programs, and 5 Diploma courses. As an institute

omnithrough quality education, MIST aims at

providing learning with technology-

edge. Two critical aspects of preparation for success in t-

he work place are Education and Training, so that

you will have the required knowledge, skills and a

high level of self-motivation including initiative and res-

ponsibility.

About the Department:

The Department of Electrical & Electronics Engineering was established in 2001 which offers B.Tech, and M.Tech (POWER Engineering and Energy Systems) courses with highly qualified, dedicated and motivated faculty. The courses and programmes offered by the department not only impart technical expertise to the students but also gives a professional experience.

Topics to be covered:

- Introduction
 - raman analysis
 - modal equation
 - Daffalias Model
 - Manzari Model
 - Equivalent Impedance and Conductance
 - Transfer Function Models
- About the FDP:

Mathcad is a product of MathSoft inc. The Mathcad can help us to calculate, graph, and communicate technical ideas. It lets us work with mathematical expressions using standard math notation - but with the added ability to recalculate, view, present, and publish with ease, even to the Web.

MAHAVEER INSTITUTE OF SCIENCE AND TECHNOLOGY



ESTD : 2001

(Affiliated to JNTUH, Hyderabad and Approved by AICTE, New Delhi)
Vyasapuri, Bandlaguda, Post: Keshavagiri, Hyderabad- 500005

organized by

Department of Electrical and Electronics Engineering

CERTIFICATE

This is certify that Akula Rakesh bearing Hall Ticket No 19E31A026
B.Tech Second Year has Participated in MATCAD Programming T
Program From 08-06-2021 to 21-06-2021 organized by Departmen
Electrical and Electronics Engineering.

HOD

Dr.M.Rajendar Reddy

Dr.M.Sudhakaran

MIST

PRINCIPAL

Dr.B.Nages

About the College

As an Institute committed in quality education, MIST aims at providing learning with a Technology-edge. It endeavors to provide consistent training to its students to help them evolve as competent professionals in the highly competitive world. Right from its inception in 2001, it has been tuning itself to meet this objective. A new civilization is emerging in our lives. This civilization brings with it a new way of working. Millions are already tuning their lives to the rhythms of tomorrow.

About the Mechanical Department

The Mechanical engineering is one of the core engineering departments, which has potential to accommodate all efficient engineers. The Mechanical engineers serve all other branches of engineering directly or indirectly. The Mechanical engineers can find their place in Automobile engineering sector, Steel Plants, Power plants, Software industries, Manufacturing industries, Design industries, Military, Naval and Air force, Defense research organizations, Material research organizations etc.

About the Workshop

AutoCAD is globally used by surveyors, designers, engineers, drafters. Globally, AutoCAD has proven as an efficient and user-friendly Program. Program.Commercial drafting and computer-aided design(CAD) software applications are AutoCAD. AutoCAD software is recognized internationally for its remarkable editing capabilities, which make it likely to digitally draw building plans or recreate 3D images. AutoCAD is compatible with other applications like 3D Max. The designers can even import or export DWG & DXG Files to the application. Also, these files can even be exported from AutoCAD to other applications for creating more improved projects & presentations.

Organising committee

CHIEF PATRON

Smt. S. Jayalakshmi Reddy

Chairman

Sri. S. Surendar Reddy

Secretary

Sri S. Dhanunjay Reddy

Joint Secretary

DIRECTOR

Dr. H. S. N. Murthy

PATRON

Dr B.V.Sanker Ram.Principal

CONVENER

Dr.B.Nageswar Rao,

Professor,Dept. Of Mechanical

PROGRAM COORDINATORS

P.Praveen Kumar Reddy

K.Devi Singh

Conducted On

01/5/2020- 13/5/2020



ETD-201

MAHAVEER
INSTITUTE OF SCIENCE & TECHNOLOGY

Approved by AICTE, Affiliated to JNTU, Hyderabad.
Visision, Bandipada, Post: Madhavgiri, Hyderabad-500065.



Two week
Certification Course
on

Auto CAD

Organized by

Department of Mechanical
Engineering

Vysapuri, Bandlaguda Post Keshavnagar,
Hyderabad-500 005, Telangana INDIA
Tel: 040-64596979, 20020773, Fax: 040-24455003
E-mail: principal.mahaveer@gmail.com
Website: www.mist.ac.in

MAHAVEER
INSTITUTE OF SCIENCE & TECHNOLOGY
Approved by AICTE, Affiliated to JNTU(Hyd)



Date: 29-04-2020

To
The Principal
MIST,
Hyderabad.

Sub: Proposal for Add-on Course-Reg,

Respected sir,

We are going to conduct 10 days Technical Training for II B. Tech students on "Introduction to Auto CAD". We require your approval to go head for proceeding and hope to get an opportunity to serve you the best.

With thanks and regards

Dr.B.Nageswar Rao

HOD

Department of Mechanical Engineering

PRINCIPAL
MAHAVEER
INSTITUTE OF SCIENCE & TECHNOLOGY
Bandlaguda, Hyd-500 005.



Date: 30.04.2020

CIRCULAR

Technical Training for H B, Tech students are starting from 1st MAY, 2020 onwards. All HODs and Placements coordinators have to manage the trainings and ensure 95% attendance all through the sessions.

All Mentors need to send the compiled feedback report to Dr.B.Nageswar Rao, HOD at e3hod.mech@gmail.com daily.

Agenda: 1. Introduction to AUTOCAD.

Design and Development of curriculum for Add on course:

Name of the Faculty : P.Praveen Kumar Reddy

Dr.B.Nageswar Rao

HOD

Department of Mechanical Engineering



Auto CAD SYLLABUS

1: Getting Started with AutoCAD

- Opening and Creating Drawings
- Exploring the AutoCAD interface
- Zooming and Panning

2: Basic Drawing & Editing Commands

- Using the Mouse, Keyboard, and Enter Key to work quickly and efficiently in AutoCAD
- Lines
- Circles
- Rectangles

3: Projects - Creating a Simple Drawing

- Creating Simple Drawings
- Using Object Snap Tracking to extrapolate a projected top view
- Using Modify tools to arrange an office layout

4: Drawing Precision in AutoCAD

- Polar and Ortho Tracking
- Entering Coordinates and Angles
- Object Snaps and Tracking

5: Making Changes in Your Drawing

- Move
- Copy
- Rotate
- Mirror
- Scale
- Using the reference option with the Scale Tool

7: Organizing Your Drawing with Layers

- Layer States
- Properties by Layer
- Layer Tools

8: Advanced Object Types

- Polylines
- Arcs

PRINCIPAL
MAHAVEER
INSTITUTE OF WELFARE & TECHNOLOGY
Bandlaguda, Hyderabad-500 075.



- Polygons
- Ellipses

9: Advanced Editing Commands

- Trim and Extend
- Fillet and Chamfer
- Polyline Edit and Spline
- Offset and Explode
- Join

10: Inserting Blocks

- The Insert Block Command
- Inserting Blocks with Tool Palettes
- Dynamic Bloes
- Migrating Blocks and other Elements between Drawings with Design Center

11: Text

- The Multiline Text Tool
- The Single Line Text Tool
- Editing Text
- Text in Model Space vs. Paper Space
- The Multileader Tool

12: Hatching

- The Hatch Command
- The Hatch Editor Ribbon Tab
- Saving and Applying Hatches with Tool Palettes

13: Adding Dimensions

- Using Dimensioning Tools
- Dimensioning in a Layout Tab vs. the Model Tab
- Using Dimension Styles
- Editing Dimensions

14: Projects - Annotating Your Drawing

- Dimensioning a Mechanical Drawing

PROFESSOR
MAHAVEER
INSTITUTE OF MANAGEMENT STUDIES
BANDLAGUDA, HYD-500 025



Department of Mechanical Engineering
Auto CAD Technical Training student attendance list 2020-21

S.NO.	ROLL NO.	NAME OF THE STUDENT	YEAR
1	19E31A0301	ABDUL QUADAR BIN ABDUL BARI	II
2	19E31A0302	BANOTH ANIL KUMAR	II
3	19E31A0303	BHUKYA VAMSHI	II
4	19E31A0304	BOMMENA RAHUL	II
5	19E31A0305	EDIGI THARUN KUMAR GOUD	II
6	19E31A0306	MD AVEZ	II
7	19E31A0307	MOHAMMED ILIYAS KHAN	II
8	19E31A0308	SANITRA DEVARA	II
9	19E31A0309	SINDE UJWAL	II
10	18E31A0320	MOHAMMED VIGAR UL HAQ SIDDIQUI	II
11	18E31A0313	MIRZA ADNAN BAIG	II
12	18E31A0315	MD ABDUL MATEEN AHMED	II
13	18E31A0318	MOHAMMED NISAR UDDIN	II
14	20E35A0301	GUBBALA SHIVA SAHITHI	II
15	20E35A0302	GUGULOTHU DINESH	II
16	20E35A0303	MOTE VYSHNAVI	II
17	20E35A0304	NERALLA SRAVYA	II
18	20E35A0305	PITTALA SAIKIRAN	II
19	20E35A0306	S ROHIT	II
20	20E35A0307	SYED SARFARAZ	II
21	20E35A0308	YELLA SAITEJA	II

(Handwritten signature and stamp)



Technical Training Exam on Auto CAD Software (A.Y-2020-21)

2x10=20 Marks

Answer All the Questions

1. Draw the given 2D model into 3D model by using AutoCad

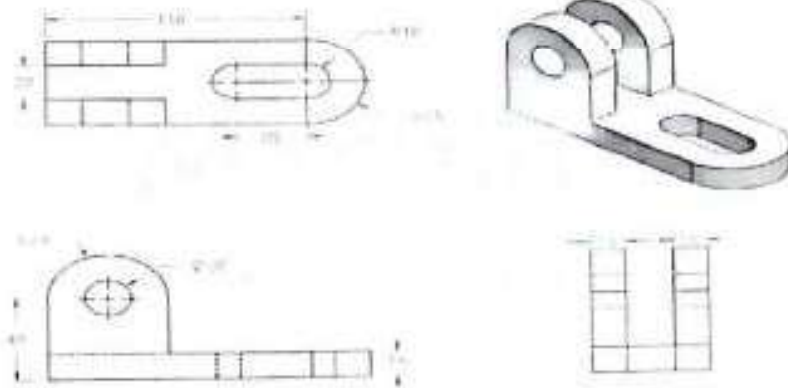

2. Draw the given 2D model into 3D model by using Auto CAD.

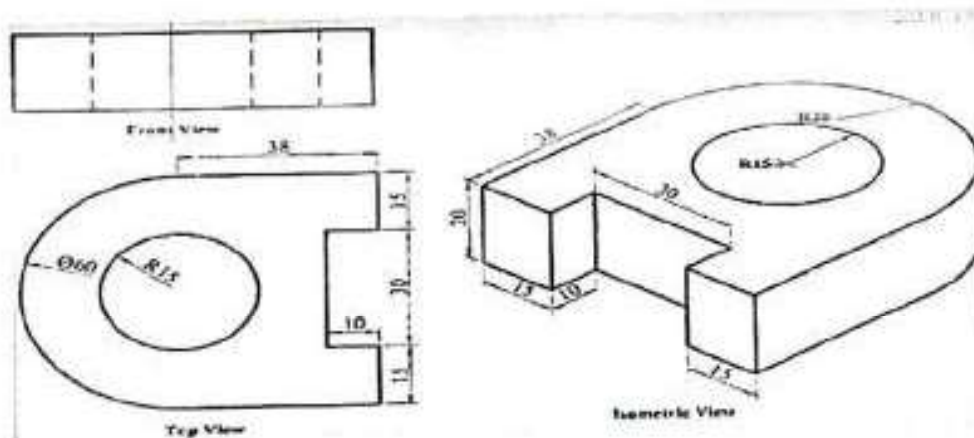

Principals
P.I.
M.A.
Institute of
Banthiguda, Hyderabad



Department of Mechanical Engineering
Auto CAD Technical Training student Marks list 2020-21

S.NO	Roll No	Name of the student	YEAR	MARKS	PASS/F
1	19E31A0301	ABDUL QUADAR BIN ABDUL BARI	II	15	PASS
2	19E31A0302	BANOTH ANIL KUMAR	II	16	PASS
3	19E31A0303	BHUKYA VAMSHI	II	18	PASS
4	19E31A0304	BOMMENA RAHUL	II	5	PASS
5	19E31A0305	EDIGI THARUN KUMAR GOUD	II	15	PASS
6	19E31A0306	MD AVEZ	II	15	PASS
7	19E31A0307	MOHAMMED ILIYAS KHAN	II	16	PASS
8	19E31A0308	SANITRA DEVARA	II	15	PASS
9	19E31A0309	SINDE UJWAL	II	16	PASS
10	18E31A0320	MOHAMMED VIGAR UL HAQ SIDDIQUI	II	12	PASS
11	18E31A0313	MIRZA ADNAN BAIG	II	5	PASS
12	18E31A0315	MD ABDUL MATEEN AHMED	II	16	PASS
13	18E31A0318	MOHAMMED NISAR UDDIN	II	12	PASS
14	20E35A0301	GUBBALA SHIVA SAHITHI	II	15	PASS
15	20E35A0302	GUGU/LOTHU DINESH	II	16	PASS
16	20E35A0303	MOTE VYSHNAVI	II	14	PASS
17	20E35A0304	NERALLA SRAVYA	II	15	PASS
18	20E35A0305	PITTALA SAIKIRAN	II	17	PASS
19	20E35A0306	S ROHIT	II	15	PASS
20	20E35A0307	SYED SARFARAZ	II	16	PASS
21	20E35A0308	YELLA SAITEJA	II	16	PASS

(Handwritten signature and stamp)



Auto CAD COURSE
Summary

Department of Mechanical Engineering

- Use AutoCAD for daily working process.
- Navigate throughout AutoCAD using major navigating tools.
- Understand the concept and techniques to draw.
- Create multiple designs using several of tools.
- Create layers to control the objects' visibility.
- Explain drawing using annotations.
- Plot or print the drawing by scale.
- To use constraint for certain design.

Copy to :

1. Department of Notice Board
2. Principal for Information
3. Committee Members (Academic)

PRINCIPAL
MAHAVEER
INSTITUTE OF TECHNOLOGY
KESHAVNAGAR, HYDERABAD

Vysapuri, Bandlaguda Post, Keshavnagar,
Hyderabad-500 005, Telangana INDIA
Tel: 040-64594979, 20020773, Fax: 040-24455003
E-mail: principal.mahaveer@gmail.com,
Website: www.mist.ac.in

MAHAVEER



Approved by AICTE. Affiliated to JNTUH Hyd.

CERTIFICATE OF COURSE COMPLETION

This certificate is presented to Mr. Shiva Sahith of
MIST, who has successfully completed technical training course on
"Auto CAD" held from 01-05-2020 to 13-05-2020 and found the
student performance to be excellent.

PRINCIPAL
MAHAVEER
INSTITUTE OF SCIENCE & TECHNOLOGY
Bandlaguda, Hyderabad-500 005.



ESTD : 2001

Dr. B. Nageswar Rao

HOD

Department of Mechanical Engineering



DEPARTMENT OF MECHANICAL ENGINEERING

List of students enrolled in Auto CAD (2020-2021)

S.No	Roll No	Name of the student	Date	15/10/21	01/5	5/5	6/5	7/5	8/5	9/5	10/5	11/5
1	19E31A0501	ABDUL QUADAR ILYAS ABDUL BARI		P	P	P	P	P	P	P	P	P
2	20E35A0506	S ROHIT		P	P	P	P	P	P	P	P	P
3	19E31A0503	BHUKYA VAMISEH		P	P	P	P	P	P	P	P	P
4	20E35A0507	SYED SARFARAZ		P	P	P	P	P	P	P	P	P
5	19E31A0305	EDIGI THAPUN KUMAR GOUD		P	P	P	P	P	P	P	P	P
6	19E31A0506	MD AVEZ		P	P	P	P	P	P	P	P	P
7	19E31A0507	MOHAMMED ILIYAS KHAN		P	P	P	P	P	P	P	P	P
8	19E31A0508	SANITRA DEVARA		P	P	P	P	P	P	P	P	P
9	19E31A0309	SINDE UJWAL		P	P	P	P	P	P	P	P	P
10	18E31A0320	MOHAMMED VIQAR UL HAQ SIDDIQUI		P	P	P	P	P	P	P	P	P

(Signature)



MAHAVEER
INSTITUTE OF SCIENCE & TECHNOLOGY
Approved by AICTE, affiliated to JNTU, Hyderabad.
Vidyanagar, Ramdurguda, Post: Kattamraju, Hyderabad-500026.

About the College

As an Institute committed in quality education, MIST aims at providing learning with a Technology-edge. It endeavors to provide consistent training to its students to help them evolve as competent professionals in the highly competitive world. Right from its inception in 2001, it has been tuning itself to meet this objective. A new civilization is emerging in our lives. This civilization brings with it a new way of working. Millions are already tuning their lives to the rhythms of tomorrow.

About Mechanical Dept.

The Mechanical engineering is one of the core engineering departments, which has potential to accommodate all efficient engineers. The Mechanical engineers serve all other branches of engineering directly or indirectly. The Mechanical engineers can find their place in Automobile engineering sector, Steel Plants, Power plants, Software industries, Manufacturing industries, Design industries, Military, Naval and Air force, Defense research organizations, Material research organizations etc.

About the Workshop

CATIA delivers the unique ability not only to model any product, but to do so in the context of its real-life behavior design in the age of experience. CATIA (Computer-Aided Three dimensional Interactive Application) software is a complete multi-platform solution for computer-aided design, manufacturing, engineering, 3D and PLM. Marketed by manufacturer Dassault Systemes, the software is ideal for creating solids, surfaces, assemblies, drawings, fabrication and analysis. However, CATIA offers more advanced functionality for surfaces and modules for different industries.

Organizing committee

CHIEF PATRON

Smt. S. Jayalakshmi Reddy

Chairman

Sri. S. Surendar Reddy

Secretary

Sri S. Dhanunjay Reddy

Joint Secretary

DIRECTOR

Dr. H. S. N. Murthy

PATRON

Dr B.V.Sanker Ram.Principal

CONVENER

Dr.B.Nageswar Rao

Proffesor, Dept. Of Mechanical

PROGRAM COORDINATORS

Mr.G.K.ShanmukhDev

Duration

06/01/2020-18/1/2020



**Two week
Certification Course
on**

Introduction to CATIA

Organized by

**Department of Mechanical
Engineering**

Yashwanth Banthiajiada Post Graduate Institute
P. Jeevan Reddy Road, D. V. Subbarao Nagar, Hyderabad
Tel: 040-44516979, 20023773, Fax: 040-24455003
E-mail: principal@yashwanth.ac.in
Website: www.yashwanth.ac.in

MAHAVEER



Approved by AICTE, Affiliated to JNTU(Hydr)

Date: 02-01-2020

To
The Principal
MIST,
Hyderabad.

Sub: Proposal for Add-on Course-Reg.

Respected sir,

We are going to conduct 10 days Technical Training for II B.Tech students on "Introduction to Catia". We require your approval to go head for proceeding and hope to get an opportunity to serve you the best.

With thanks and regards

PRINCIPAL
MAHAVEER
P. Jeevan Reddy Road, D. V. Subbarao Nagar,
Hyderabad, Hyderabad-500 005.

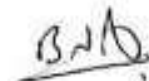
Dr. B. Nageswar Rao
HOD

Department of Mechanical Engineering



Date: 03.01.2020

CIRCULAR

Technical Training for III B. Tech students are starting from 6th January, 2020 onwards. All HODs and Placements coordinators have to manage the trainings and ensure 95% attendance all through the sessions.

All Mentors need to send the compiled feedback report to Dr.B.Nageswar Rao, HOD.

Agenda:

1. Introduction to CATIA.

Design and Development of curriculum for Add on course:

1.Name of the Faculty : G.K.Shanmukh Dev



B.N.R.

Dr.B.Nageswar Rao

HOD

Department of Mechanical Engineering



CATIA SYLLABUS

Total Hours: 30

I. Introduction:

- Modulus
- Features (powerful Tools)
- Parametric modeling
- Feature based approach
- Parent – child Relationship)
- Associative and Model Centric
- b) Information about Interface
- Tools, Menu, etc.

II. Sketcher:

- Getting Started
- Interface
- Sketch tools
- Profiles
- Operations
- Constraints
- Sketcher preferences
- References

III. Part Features:

- Sketch Based Features
- Pad
- Pocket
- Thin
- Shaft
- Groove

PRINCIPAL
MAHAVEER
INSTITUTE OF SCIENCE & TECHNOLOGY
BANDLAGUDA, HYD-500 005.



- Hole
- Threaded Hole
- Rib
- Slot
- Multi section solid

IV. Dress-up Features

- Fillet
- Chamfer
- Draft
- Shell
- Thickness
- Thread/Tap

VI. Assembly Modeling:

- Assembly Constraints
- Manipulation
- Defining a multi & fast multi-instantiation
- Analyzing an assembly

VII. Drafting:

- Sheets & Views
- View modification
- Generating dimensions
- Bill of material
- Dimensions
- Annotations
- Dress up Elements
- Properties
- Exporting and Importing files

PRINCIPAL
MAHAVEER
INSTITUTE OF SCIENCE & TECHNOLOGY
Bandlaguda, Hyderabad-500025



Department of Mechanical Engineering CATIA Technical Training student attendance list 2020-21

SL.NO.	ROLL NO	NAME OF THE STUDENT	YEAR
1	18E31A0301	B ABHILASH CHARY	III
2	18E31A0302	BANOTHU DIVYA	III
3	18E31A0304	CHAKKALA RAJNATH SIMHA	III
4	18E31A0305	GADDALA JAGADISH BIHARAT KUMAR	III
5	18E31A0307	JANGA SAIKRISHNA	III
6	18E31A0308	JARIBANDA SAI RAMREDDY	III
7	18E31A0309	KASTHURI ARUN KUMAR	III
8	18E31A0314	MIRZA QUSRO BAIG	III
9	18E31A0322	MOHD ABDUL JUNAID	III
10	18E31A0323	MOHD AZHARUDDIN	III
11	18E31A0324	MOHD FAZAL	III
12	18E31A0325	MUJTABA AHMED	III
13	18E31A0326	P CHAITANYA	III
14	18E31A0327	PATHI ABHINAV	III
15	18E31A0328	PATHI ABHISHEK	III
16	18E31A0329	PEDININTI SURAJ KUMAR	III
17	18E31A0330	PENDYALA RANJEETH KUMAR	III
18	18E31A0331	SADHU THIRUJITHI	III
19	18E31A0332	SAHADEVUDU BALAJI	III
20	18E31A0333	SANTHAPURI PHALGUN	III
21	18E31A0334	SUNKI REDDY RUTHVIK REDDY	III
22	18E31A0335	VALLALA SAIKRISHNA	III
23	18E31A0336	YEPURI PRASHANTH	III

PRINCIPAL
MAHAVEER
INSTITUTE OF SCIENCE & TECHNOLOGY
Bandlaguda, Hyderabad-505015

Vyasaiah Bandhujada Post-Kolhapur
Hyderabad-500 005, Telangana-India
Tel: 040-44596979-20020773, Fax: 040-24455003
E-mail: principal.mahaveer@gmail.com
Website: www.mahaveer.com

MAHAVEER



Approved by AICTE - Affiliated to JNTU(H)Hyd

24	18E31A0337	YOGI SH PAWAN GUMMADI	III
25	19E35A0301	A SAI KUMAR	III
26	19E35A0303	CHANDAPAKA AJAYKUMAR	III
27	19E35A0304	DERESI CHANDRA DANIEL BULLA	III
28	19E35A0305	ENDARAPU MADHU	III
29	19E35A0306	GOVINDU DINESH REDDY	III
30	19E35A0307	MADDASANI SAI VIKAS	III
31	19E35A0308	SURVI RAKESH	III
32	19E35A0309	VANAPARTHI NIKHIL	III
33	19E35A0310	VEMULAPALLI GOPI	III
34	17D91A0306	CHUKKA PRADEEP	III
35	18D91A0302	AHMED FARAZUDDIN	III
36	18D91A0313	MD NASHEED AHMED	III
37	18D91A0326	SHUAIB ABDUL HAMEED	III
38	17M31A0307	MOHAMMED ABUDUL KHALID	III
39	17E31A0331	MOHAMMED MOAZZAM ALI	III
40	17E31A0335	MOHAMMED SAMEER MUNAWAR HUSSAIN	III
41	17H11A0303	HABEEB SYED MUSTAFA	III
42	15E91A0583	N ARUN	III
43	16H11A0348	MOHAMMED BARIQ	III
44	16M31A0301	ABDUL NAYEEM	III
45	16M31A0304	AWADESH KUMAR	III
46	17E31A0307	CH KARTHIK REDDY	III
47	17E31A0312	GOLLA MADIHUSUDHAN	III
48	17E31A0317	KARRE PRABHAKAR	III
49	17E31A0321	K SAI KUMAR	III

Principal
MAHAVEER
18E31A0337
Vyasaiah Bandhujada Post-Kolhapur
Hyderabad-500 005

Vysapuri, Bandlaguda Post Keshavnagar,
Hyderabad-500 005, Telangana-INDIA
Tel: 040-64594279, 20920773, Fax: 040-24455003
E-mail: principal.mahaveer@gmail.com
Website: www.meeit.ac.in

MAHAVEER



Approved by AICTE, Affiliated to JNTU, Hyderabad

50	17E31A0323	M ABHISHEK	III
51	17E31A0322	MOHAMMED MUSABUDDIN	III
52	17E31A0336	MD ABIDUL AASEEM RAHIL	III
53	17E31A0347	SAAD BIN SIKANDER	III
54	17E31A0349	SHAIK ABDUL RAB	III
55	17E31A0350	SHAIK MOHD ZAKIR SHAMIM	III
56	17E31A0351	SHAIK SHAHBAZ	III
57	17E31A0357	TEJAVATH LAXMAN	III
58	17E31A0359	VENI REDDY VENUGOPAL REDDY	III
59	17E31A0361	YALAL VINAYAK REDDY	III
60	18E35A0320	MOHAMMAD KAIF UR ZAMA	III

PRINCIPAL
MAHAVEER
INSTITUTE OF SCIENCE & TECHNOLOGY
Bandlaguda, Hyd-500 005



Technical Training Exam on Catia Software (A.Y-2020-21)

2x10=20 Marks

Answer All the Questions

1. Draw the given figure by using Catia software.

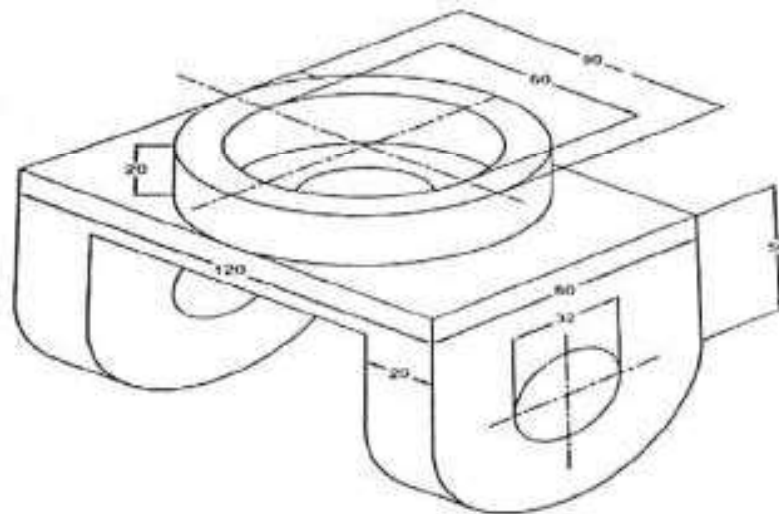

2. Draw the given 2D model into 3D model by using Catia.

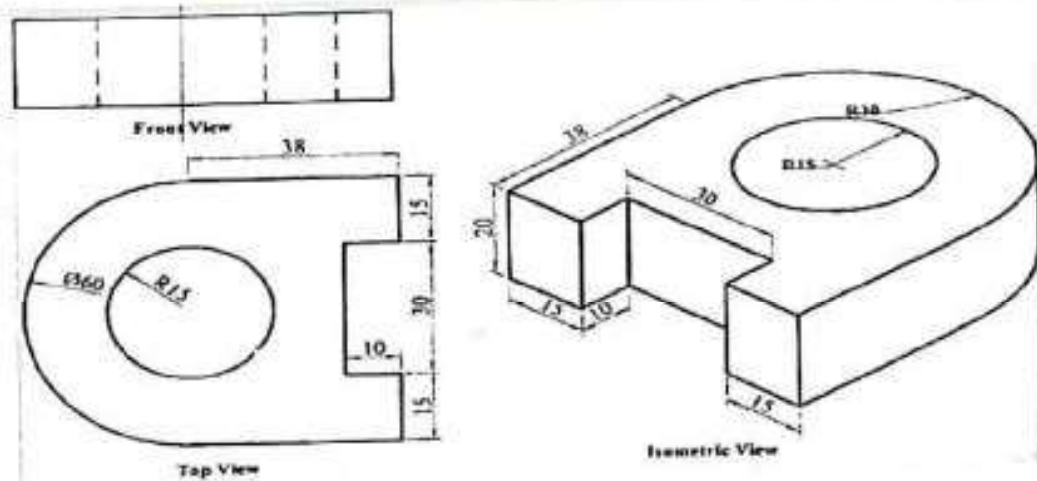

Principal
MAHAVEER
Vysapatti, Bandlaguda Post, Krishna
Hyderabad 500 005, Telangana INDIA



Department of Mechanical Engineering
CATIA Technical Training student Marks list 2020-21

Sl.NO	Roll No	Name of the student	YEAR	MARKS	PASS/F
1	18E31A0301	B ABHILASH CHARY	III	15	PAS!
2	18E31A0302	BANOTHU DIVYA	III	16	PAS!
3	18E31A0304	CHAKKALA RAJNATH SIMHA	III	18	PAS!
4	18E31A0305	GADDALA JAGADISH BHARAT KUMAR	III	15	PAS!
5	18E31A0307	JANGA SAIKRISHNA	III	15	PAS!
6	18E31A0308	JARIBANDA SAI RAMREDDY	III	15	PAS!
7	18E31A0309	KASTHURI ARUN KUMAR	III	15	PAS!
8	18E31A0314	MIRZA QUSRO BAIG	III	15	PAS!
9	18E31A0322	MOHD ABDUL JUNAID	III	16	PAS!
10	18E31A0323	MOHD AZHARUDDIN	III	12	PAS!
11	18E31A0324	MOHD FAZAL	III	15	PAS!
12	18E31A0325	MUJTABA AHMED	III	16	PAS!
13	18E31A0326	P CHAITANYA	III	12	PAS!
14	18E31A0327	PATHI ABHINAV	III	15	PAS!
15	18E31A0328	PATIL ABHISHEK	III	16	PAS!
16	18E31A0329	PEDININTI SURAJ KUMAR	III	14	PAS!
17	18E31A0330	PENDYALA RANJEETH KUMAR	III	15	PAS!
18	18E31A0331	SADHU THRUJITH	III	17	PAS!
19	18E31A0332	SAHADEVUDU BALAJI	III	15	PAS!

M. MAHAVEER
Principal
MAHAVEER INSTITUTE OF TECHNOLOGY
BANDLAGUDA, HYDRABAD



Department of Mechanical Engineering
CATIA Technical Training student Marks list 2020-21

Sl.NO	Roll No	Name of the student	YEAR	MARKS	PASS/F
1	18E31A0301	B ABHILASH CHARY	III	15	PASS
2	18E31A0302	BANOTHU DIVYA	III	16	PASS
3	18E31A0304	CHAKKALA RAJNATH SIMHA	III	18	PASS
4	18E31A0305	GADDALA JAGADISH BHARAT KUMAR	III	15	PASS
5	18E31A0307	JANGA SAIKRISHNA	III	15	PASS
6	18E31A0308	JARIBANDA SAI RAMREDDY	III	15	PASS
7	18E31A0309	KASTHURI ARUN KUMAR	III	15	PASS
8	18E31A0314	MIRZA QUSRO BAIG	III	15	PASS
9	18E31A0322	MOHD ABDUL JUNAID	III	16	PASS
10	18E31A0323	MOHD AZHARUDDIN	III	12	PASS
11	18E31A0324	MOHD FAZAL	III	15	PASS
12	18E31A0325	MUJTABA AHMED	III	16	PASS
13	18E31A0326	P CHAITANYA	III	12	PASS
14	18E31A0327	PATHI ABHINAV	III	15	PASS
15	18E31A0328	PATIL ABHISHEK	III	16	PASS
16	18E31A0329	PEDININTI SURAJ KUMAR	III	14	PASS
17	18E31A0330	PENDYALA RANJEETH KUMAR	III	15	PASS
18	18E31A0331	SADHU THRUJITH	III	17	PASS
19	18E31A0332	SAHADEVUDU BALAJI	III	15	PASS

 M. A. V. S. R.
 18/11/2021
 Director, Mahaveer Institute of Technology



20	18E31A0333	SANTHAPURI PHALGUN	III	16	PAS
21	18E31A0334	SUNKI REDDY RUTHVIK REDDY	III	16	PAS
22	18E31A0335	VALLALA SAIKRISHNA	III	15	PAS
23	18E31A0336	YEPURI PRASHANTH	III	16	PAS
24	18E31A0337	YOGESH PAWAN GUMMADI	III	14	PAS
25	19E35A0301	A SAI KUMAR	III	15	PAS
26	19E35A0303	CHANDAPAKA AJAYKUMAR	III	15	PAS
27	19E35A0304	DERESH CHANDRA DANIEL BULLA	III	16	PAS
28	19E35A0305	ENDARAPU MADHU	III	14	PAS
29	19E35A0306	GOVINDU DINESH REDDY	III	15	PAS
30	19E35A0307	MADDASANI SAI VIKAS	III	15	PAS
31	19E35A0308	SURVI RAKESH	III	14	PAS
32	19E35A0309	VANAPARTHI NIKHIL	III	16	PAS
33	19E35A0310	VEMULAPALLI GOPI	III	16	PAS
34	17D91A0306	CHUKKA PRADEEP	III	14	PAS
35	18D91A0302	AHMED FARAZUDDIN	III	15	PAS
36	18D91A0313	MD NASHEED AHMED	III	16	F-3
37	18D91A0326	SHUAIB ABDUL HAMEED	III	15	PAS
38	17M31A0307	MOHAMMED ABUDUL KHALID	III	16	PAS
39	17E31A0331	MOHAMMED MOAZZAM ALI	III	14	PAS
40	17E31A0335	MOHAMMED SAMEER MUNAWAR HUSSAIN	III	12	PAS
41	17H11A0303	HABEEB SYED MUSTAFA	III	15	PAS
42	15D91A0383	N ARUN	III	16	PAS

Principal
 MAHAVEER
 Education Society
 Hyderabad

Vysarim, Bandlaguda Post Kothavaram
Hyderabad-500 028. Tel: 040-2445000
Tel. 040-2445079, 20020775, Fax: 040-2445003
E-mail: principal.mahaveer@gmail.com
Website: www.mst.ac.in

MAHAVEER



Approved by AICTE. Affiliated to JNTUHYD

43	16H11A0348	MOHAMMED BARIQ	III	15	PAS
44	16M31A0301	ABDUL NAYEEM	III	16	PAS
45	16M31A0304	AWADESH KUMAR	III	15	PAS
46	17E31A0307	CH KARTHIK REDDY	III	14	PAS
47	17E31A0312	GOLLA MADHUSUDHAN	III	18	PAS
48	17E31A0317	KARRE PRABHAKAR	III	15	PAS
49	17E31A0321	K SAI KUMAR	III	16	PAS
50	17E31A0323	M ABHISHEK	III	15	PAS
51	17E31A0332	MOHAMMED MUSAIB UDDIN	III	16	PAS
52	17E31A0336	MD ABDULAASEEM RAHIL	III	15	PAS
53	17E31A0347	SAAD BIN SIKANDER	III	16	PAS
54	17E31A0349	SHAIK ABDUL RAB	III	14	PAS
55	17E31A0350	SHAIK MOHD ZAKIR SHAMIM	III	12	PAS
56	17E31A0351	SHAIK SHAHBAZ	III	15	PAS
57	17E31A0357	TEJAVATH LAXMAN	III	16	PAS
58	17E31A0359	VEMI REDDY VENUGOPAL REDDY	III	15	PAS
59	17E31A0361	YALAL VINAYAK REDDY	III	16	PAS
60	18E35A0320	MOHAMMAD KAIF UR ZAMA	III	15	PAS

PRINCIPAL
MAHAVEER
INSTITUTE OF MANAGEMENT STUDIES
Vysarim, Bandlaguda Post, Hyderabad.



CATIA COURSE Summary

- In this course, you will learn how to utilize the core functionality enhancements in Catia.
- First, you will become familiar with using and customizing the new ribbon interface in Catia.
- The new measure and sectioning interfaces will also be examined. Next, you will become familiar with the Sketcher workflow and reference enhancements.
- Part modeling enhancements to features such as Extrude, Corner Chamfer, Sweeps, Blends, and Datum Curves will then be examined.
- You will also learn about new and enhanced Assembly capabilities, such as selecting multiple components, the new relationship constraints, and enhancements for dragging components.
- Then, you will examine the new Table and Balloon functionality for 2-D drawings, and review various detailing enhancements.
- At the end of each module, you will complete a set of review questions to reinforce critical topics from that module. At the end of the course, you will complete a course assessment in Catia intended to evaluate your understanding of the course as a whole.

Copy to :

1. Department of Notice Board
2. Principal for Information
3. Committee Members (Academic)



Venugopal, Bandlaguda Post, Mahaveer
Hills, Hyderabad 500 005, Telangana, INDIA
Tel: 040 44556579, 23020773, Fax: 040 24451003
E-mail: principal.mahaveer@gmail.com
Website: www.mist.ac.in

MAHAVEER



Approved by AICTE, Affiliated to JNTUH Hyd

CERTIFICATE OF COURSE COMPLETION

This certificate is presented to A. Sai Kumar of
MIST, who has successfully completed technical training course on
"CATIA" held from 01-01-2020 to 18-01-2020 and found the
student performance to be excellent.



ESTD : 2001

Dr. B. Nageswara Rao

HOD

Department of Mechanical Engineering

PRINCIPAL
MAHAVEER
INSTITUTE OF SCIENCE & TECHNOLOGY
Bandlaguda, Hyderabad-500 005.



DEPARTMENT OF MECHANICAL ENGINEERING

List of students enrolled in CATIA (2020-2021)

S.No	Roll No	Name of the student	Date	11/11/20	12/11/20	13/11/20	14/11/20	15/11/20	16/11/20	18/11/20
1	18E31A0301	B ABHILASH CHARY		P	P	P	P	P	P	P
2	18E31A0302	BANOTHU DIVYA		P	P	P	P	P	P	P
3	18E31A0304	CHAKKALA RAJNATH SIMILA		P	P	P	P	P	P	P
4	18E31A0305	GADDALA JAGADISH BHARAT KUMAR		P	P	P	P	P	P	P
5	18E31A0307	JANGA SAKRISINA		P	P	P	P	P	P	P
6	18E31A0308	JARIBANDA SAIRAM REDDY		P	P	P	P	P	P	P
7	18E31A0309	KASTHURI ARUN KUMAR		P	P	P	P	P	P	P
8	18E31A0314	MIRZA QUSRO BANO		P	P	P	P	P	P	P
9	18E31A0322	MOHD ABDUL JUNAID		P	P	P	P	P	P	P
10	18E31A0323	MOHD AZHARUDIN		P	P	P	P	P	P	P
11	18E31A0324	MOHD FAZAL		P	P	P	P	P	P	P
12	18E31A0325	MUJTABA AHMED		P	P	P	P	P	P	P
13	18E31A0326	P CHAITANYA		P	P	P	P	P	P	P
14	18E31A0327	PATHI ABHINAV		P	P	P	P	P	P	P
15	18E31A0328	PATIL ABHISHEK		P	P	P	P	P	P	P
16	18E31A0329	PEDININTI SURAJ KUMAR		P	P	P	P	P	P	P
17	18E31A0330	PUNDYALA RANJITH KUMAR		P	P	P	P	P	P	P

(Signature)
Principal
MAHAVEER
Engineering College
Basalinguda Post, Khurda District,
Hyderabad-500 005, Telangana 500003

About the College

As an Institute committed in quality education, MIST aims at providing learning with a Technology-edge. It endeavors to provide consistent training to its students to help them evolve as competent professionals in the highly competitive world. Right from its inception in 2001, it has been tuning itself to meet this objective. A new civilization is emerging in our lives. This civilization belongs with a new way of working. Millions are already tuning their lives to the rhythms of tomorrow.

About Mechanical Dept.

The Mechanical engineering is one of the core engineering departments, which has potential to accommodate all efficient engineers. The Mechanical engineers serve all other branches of engineering directly or indirectly. The Mechanical engineers can find their place in Automobile engineering sector, Steel Plants, Power plants, Software industries, Manufacturing industries, Design industries, Military, Naval and Air force, Defense research organizations, Material research organizations etc.

About the Workshop

The course builds from the big ideas in finite element analysis and computational fluid dynamics to ANSYS case studies that progress from real world applications and examples. ANSYS is the flagship engineering software solution that uses finite element analysis (FEA), which is a numerical and computational method used to solve the real engineering problems related to physics, structural analysis, heat transfer, fluid flow, mass transport, and electromagnetic potential field. To solve the problem, it subdivides a large problem into smaller, simpler parts that are called finite elements and solve the problem by minimizing an associated error function.

Organising committee

CHIEF PATRON

Smt. S. Jayalakshmi Reddy

Chairman

Sri. S. Surendar Reddy

Secretary

Sri S. Dhanunjay Reddy

Joint Secretary

DIRECTOR

Dr. H. S. N. Murthy

PATRON

Dr B.V.Sanker Ram. Principal

CONVENER

Dr.B.Nageswar Rao,

Professor, Dept. Of Mechanical

PROGRAM COORDINATORS

B.Venkateswar Reddy

Conducted On

06/01/2020- 18/01/2020



MAHAVEER

INSTITUTE OF SCIENCE & TECHNOLOGY

Approved by AICTE, Affiliated to JNTU, Hyderabad.

Wasteapet, Sangareddy, Dist: Keshavnagar, Hyderabad-500005.

ESTD - 2001

ANSYS®

**Two week
Certification Course
on**

ANSYS

Organized by

**Department of Mechanical
Engineering**

Vysapuri, Bandlaguda Post, Keshavnagar,
Hyderabad-500 005, Telangana (INDIA)
Tel: 040-64596979, 20020773, Fax: 040-24455003
E-mail: principal.mahaveer@gmail.com,
Website: www.mist.ac.in

MAHAVEER

INSTITUTE OF SCIENCE & TECHNOLOGY
Approved by AICTE, Affiliated to JNTU(Hydr)



To
The Principal
MIST,
Hyderabad.

Date: 02-01-2020

Sub: Proposal for Add-on Course-Reg.

Respected sir,

We are going to conduct 10 days Technical Training for II B. Tech students on "Introduction to "ANSYS". We require your approval to go head for proceeding and hope to get an opportunity to serve you the best.

With thanks and regards

Dr.B.Nageswar Rao

HOD

Department of Mechanical Engineering

PRINCIPAL
MAHAVEER
INSTITUTE OF SCIENCE & TECHNOLOGY
Bandlaguda, Hyderabad-500 005



Date: 03.01.2020

CIRCULAR

Technical Training for IV B. Tech students are starting from 6th January, 2020 onwards. All HODs and Placements coordinators have to manage the trainings and ensure 95% attendance all through the sessions.

All Mentors need to send the compiled feedback report to Dr.B.Nageswar Rao, HOD at e3hod.mech@gmail.com daily.

Agenda: I. Introduction to ANSYS.

Design and Development of curriculum for Add on course:

Name of the Faculty : B.Venkateswar Reddy

BVR

Dr. B. Venkateswar Rao

HOD

Department of Mechanical Engineering

PRINCIPAL
M. MAHAVEER
TECHNOLOGIST
VENAPURI, BANDLAGUDA POST, KESHAVNAGAR,
HYDERABAD - 500 005.



ANSYS SYLLABUS

S.NO	TOPIC COVERED	DURATION (Hours)
1	INTRODUCTION TO FEA AND	3
2	BASIC SOLID MODELING	3
3	ADVANCED SOLID MODELING	3
4	FINITE ELEMENT MODELING (FEM) – I	3
5	FINITE ELEMENT MODELING (FEM) – II	3
6	SOLUTION AND POSTPROCESSOR	3
7	STATIC STRUCTURAL ANALYSIS	3
8	ADVANCED STRUCTURAL ANALYSIS (DYNAMIC AND NONLINEAR)	3
9	ADVANCED STRUCTURAL ANALYSIS	2
10	THERMAL ANALYSIS	2
11	GENERATING THE REPORT OF ANALYSIS	2



Department of Mechanical Engineering ANSYS Technical Training student attendance list 2020-21

S.NO.	ROLL NO.	NAME OF THE STUDENT	YEAR
1	17E31A0301	AILNENI HARSHITH	IV
2	17E31A0302	ALLA RAJA	IV
3	17E31A0304	BANGARI MOHAN	IV
4	17E31A0305	BASANOLA JAYVARDHAN	IV
5	17E31A0306	BEJJANKI MAHESH REDDY	IV
6	17E31A0308	DANDU SANJEEV	IV
7	17E31A0309	DEPA JAYANDER REDDY	IV
8	17E31A0311	G ABHILASH REDDY	IV
9	17E31A0313	GUGGILLA VENKAT SAI	IV
10	17E31A0314	GUNNAM VENKATA LAKSHMI AKHILA	IV
11	17E31A0316	KANNA MANIKANTA	IV
12	17E31A0320	KONDURU PAVAN KUMAR	IV
13	17E31A0322	M A GHOUSE	IV
14	17E31A0324	MALLETHULA RAHUL	IV
15	17E31A0325	MALLISETTI PREM SAI	IV
16	17E31A0326	MANGILGI MAHESH	IV
17	17E31A0327	MANKENA PRUDHIVIRAJ	IV
18	17E31A0328	MD ARMAN	IV
19	17E31A0333	MOHAMMED RAYEES	IV
20	17E31A0339	NALLAMPALLY SRIKANTH REDDY	IV
21	18E35A0301	AKULA GRIDDIAR YADAV	IV
22	18E35A0302	AYIDALAPALLY SHYAM KUMAR	IV
23	18E35A0303	B CHANDRA SEKHAR	IV
24	18E35A0305	BASUDE SAGAR	IV
25	18E35A0306	BOLLAM NARESH	IV
26	18E35A0307	CH RAJU	IV
27	18E35A0308	CHINNABOSKA MAHESH	IV
28	18E35A0309	CHINNAPAGU SWETHA	IV
29	18E35A0310	DODLA PRATHAP	IV
30	18E35A0311	G UMA MAHESHWARI	IV
31	18E35A0312	GOKA SAIKRISHNA	IV
32	16M31A0322	TELUSRI AJAY	IV
33	17M31A0306	SYED MOHAMMED FAIZAN GHORI	IV

 PRINCIPAL
 MAHAVEER
 INSTITUTE OF SCIENCE & TECHNOLOGY
 Bandlaguda

Vysaapuri, Bandlaguda Post, Keshavnagar
Hyderabad 500 005, Telangana INDIA
Tel: 040-84596979, 20020773, Fax: 040-24451003
E-mail: principal@mahaveer@gmail.com
Website: www.mahaveer.ac.in

MAHAVEER



Approved by AICTE - Affiliated to JNTU-Hyd

34	18M35A0308	MOHD FIRASATH ALI	IV
35	16E31A0330	PUTTAPAD YADALAH	IV
36	17E35A0317	P TARUN KUMAR	IV
37	16E31A0333	R HEMANTH KUMAR	IV
38	17E31A0342	P BILARGAV KUMAR	IV
39	17E31A0343	PILLI AKHIL BABU	IV
40	17E31A0344	POLNENI SAITEJA	IV
41	17E31A0346	RUDRARAJU DEEPANKAR SARAVANA VARMA	IV
42	17E31A0348	SATHYAPRASAD POOJA	IV
43	17E31A0352	SHAIKH FAIZAN RAZA	IV
44	17E31A0354	SHARAVAN SUTHAR	IV
45	17E31A0355	T BUNNY	IV
46	17E31A0360	YADAMA SATHISH REDDY	IV
47	18E35A0313	GUDA VIKAS	IV
48	18E35A0314	JALUKURI RAM MURTHI	IV
49	18E35A0315	KANDE VINEETH	IV
50	18E35A0317	MADUGULA GOPALA KRISHNA	IV
51	18E35A0318	MEGAVATH MAHIPAL	IV
52	18E35A0321	NITIN MAHENDRAKAR	IV
53	18E35A0322	NUNAVATH LINGAM	IV
54	18E35A0323	RAPOLU SRIKANTH	IV
55	18E35A0324	THOTLA MAHENDER	IV
56	18E35A0325	V PRANEESH	IV
57	16621A0316	SYED ABUBAKAR	IV
58	17D91A0303	AMPALLY NITHIN KUMAR	IV
59	17D91A0304	BAROOR ARVIND REDDY	IV
60	17D91A0307	DESANI SANDEEP REDDY	IV
61	17D91A0308	DIDDI ROSHAN SAI	IV
62	17D91A0309	GOLKONDA NITHISH YADAV	IV
63	17D91A0311	GUNTUKA RAMBABU	IV
64	17D91A0316	MOHAMMAD IRFAN	IV
65	17D91A0320	MULA SATHVIK REDDY	IV
66	17D91A0324	SADUVULA DEVENDER	IV
67	17D91A0325	SAMALLA DIVAKAR	IV
68	17D91A0330	VODNALA ADITHYA	IV
69	18D95A0301	BEERA PRAVEEN KUMAR	IV
70	18D95A0303	GAJULA SANGEETH KUMAR	IV
71	18D95A0305	M ASHWINKANTH	IV
72	18D95A0306	MANDAPELLI SRIKANTH	IV
73	18D95A0307	MOOD HATHIRAM	IV

PRINCIPAL
MAHAVEER
INSTITUTE OF SCIENCE & TECHNOLOGY
Bandlaguda, Hyd-500 005.

Vysapur, Bandlaguda Post Keshavn,
Hyderabad-509 005, Telangana INDIA
Tel: 040-64596979 20020773, Fax: 040-24455003
E-mail: principal.mahaveer@gmail.com
Website: www.mist.ac.in

MAHAVEER



Approved by AICTE, Affiliated to JNTUH Hyd

74	18D95A0310	SARE SRIKANTH	IV
75	17E35A0307	K SURESH	IV

PRINCIPAL
MAHAVEER
JNTUH
Bandlaguda, Hyd-509 005



Technical Training Exam on ANSYS Software (A.Y-2020-21)

2x10=20 Marks

Answer All the Questions

1.

Given the 2D truss structure represented in Figure 1.1, where:

- $h = 5 \text{ m}$
- $L = 5 \text{ m}$
- $F = 1000 \text{ N}$
- $E = 1.0 \times 10^7 \text{ N/m}^2$ (Young's modulus)
- $A = 0.1 \text{ m}^2$ (Cross-section area of each beam element)

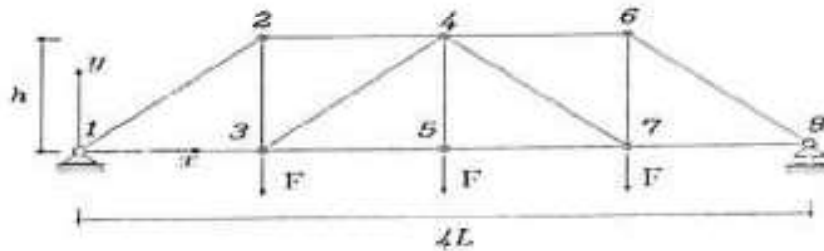

Figure 1.1: Example truss structure, constraints and loads.

2.

- 7.13 Determine the stresses in the plate with the hole subjected to the tensile stress shown in Figure P7-13. Graph the stress variation σ_x versus the distance y from the hole. Let $E = 200 \text{ GPa}$, $\nu = 0.25$, and $t = 25 \text{ mm}$. (Use various mesh densities, depending on your computer program in your finite element model.) Use symmetry as appropriate.



Figure P7-13



Department of Mechanical Engineering					
ANSYS Technical Training student attendance list 2020-21					
S.NO	Roll No	Name of the student	YEAR	MARKS	PASS/FAIL
1	17E31A0301	AILNENI HARSHITH	IV	15	PASS
2	17E31A0302	ALLA RAJA	IV	16	PASS
3	17E31A0304	BANGARI MOHAN	IV	18	PASS
4	17E31A0305	BASANOLA JAYVARDHAN	IV	15	PASS
5	17E31A0306	BEJANKI MAHESH REDDY	IV	15	PASS
6	17E31A0308	DANDU SANJEEV	IV	15	PASS
7	17E31A0309	DEPA JAYANDER REDDY	IV	16	PASS
8	17E31A0311	G ABHILASH REDDY	IV	15	PASS
9	17E31A0313	GUGGILLA VENKAT SAI	IV	16	PASS
10	17E31A0314	GUNNAM VENKATA LAKSHMI AKHILA	IV	12	PASS
11	17E31A0316	KANNA MANIKANTA	IV	14	PASS
12	17E31A0320	KONDURU PAVAN KUMAR	IV	16	PASS
13	17E31A0322	M A GHOUSE	IV	12	PASS
14	17E31A0324	MALLETHULA RAHUL	IV	15	PASS
15	17E31A0325	MALLISETTI PREM SAI	IV	16	PASS
16	17E31A0326	MANGILGI MAHESH	IV	14	PASS
17	17E31A0327	MANKENA PRUDHVIRAJ	IV	15	PASS
18	17E31A0328	MD ARMAN	IV	17	PASS
19	17E31A0333	MOHAMMED RAYEES	IV	15	PASS
20	17E31A0339	NALLAMPALLY SRIKANTH REDDY	IV	16	PASS
21	18E35A0301	AKHILA GIRIDHAR YADAV	IV	16	PASS
22	18E35A0302	AYIDAL APALLY SHYAM KUMAR	IV	15	PASS
23	18E35A0303	B CHANDRA SEKHAR	IV	16	PASS
24	18E35A0305	BASUDE SAGAR	IV	12	PASS
25	18E35A0306	BOLLAM NARESH	IV	15	PASS
26	18E35A0307	CH RAJU	IV	16	PASS
27	18E35A0308	CHINNABOSKA MAHESH	IV	14	PASS
28	18E35A0309	CHINNAPAGU SWETHA	IV	15	PASS
29	18E35A0310	DODLA PRATHAP	IV	17	PASS
30	18E35A0311	G UMA MAHESHWARI	IV	15	PASS
31	18E35A0312	GOKA SAIKRISHNA	IV	16	PASS
32	16M31A0322	TELUSRI AJAY	IV	16	PASS

Vysapuri, Bommalaguda Post, Keshavnagar,
Hyderabad-500 005, Telangana, INDIA
Tel: 040-84596979, 20020773, Fax: 040-24455003
E-mail: principal@mahaveer@gmail.com
Website: www.mahaveer.in

MAHAVEER



Approved by AICTE, Affiliated to JNTU H/1

33	17M31A0306	SYED MOHAMMED FAIZAN GHORI	IV	15	PASS
34	18M35A0308	MOHD FIRASATH ALI	IV	17	PASS
35	16E31A0330	PUTTAPAD YADALAH	IV	15	PASS
36	17E35A0317	P TARUN KUMAR	IV	16	PASS
37	16E31A0333	R HEMANTH KUMAR	IV	16	PASS
38	17E31A0342	P BHARGAV KUMAR	IV	15	PASS
39	17E31A0343	PILLAKHIL BABU	IV	16	PASS
40	17E31A0344	POLNENI SAITEJA	IV	16	PASS
41	17E31A0346	RUDRARAJU DEEPANKAR SARAVANA VARMA	IV	15	PASS
42	17E31A0348	SATHYAPRASAD POOJA	IV	16	PASS
43	17E31A0352	SHAIKH FAIZAN RAZA	IV	12	PASS
44	17E31A0354	SHARAVAN SUTHAR	IV	15	PASS
45	17E31A0355	T BUNNY	IV	16	PASS
46	17E31A0360	YADAMA SATHISH REDDY	IV	14	PASS
47	18E35A0313	GUDA VIKAS	IV	15	PASS
48	18E35A0314	JALUKURI RAM MURTHI	IV	17	PASS
49	18E35A0315	KANDE VINEETH	IV	15	PASS
50	18E35A0317	MADUGULA GOPALA KRISHNA	IV	16	PASS
51	18E35A0318	MEGAVATH MAHIPAL	IV	16	PASS
52	18E35A0321	NITIN MAHENDRAKAR	IV	15	PASS
53	18E35A0322	NUNAVATH LINGAM	IV	17	PASS
54	18E35A0323	RAPOLU SRIKANTH	IV	15	PASS
55	18E35A0324	THOTLA MAHENDER	IV	16	PASS
56	18E35A0325	V PRANESH	IV	16	PASS
57	16621A0316	SYED ABUBAKAR	IV	16	PASS
58	17D91A0303	AMPALLY NITHIN KUMAR	IV	16	PASS
59	17D91A0304	BAROOR ARVIND REDDY	IV	14	PASS
60	17D91A0307	DESANI SANDEEP REDDY	IV	16	PASS
61	17D91A0308	DIDDI ROSHAN SAI	IV	12	PASS
62	17D91A0309	GOLKONDA NITHISH YADAV	IV	15	PASS
63	17D91A0311	GUNTUKA RAMBABU	IV	16	PASS
64	17D91A0316	MOHAMMAD IRFAN	IV	14	PASS
65	17D91A0320	MULA SATHIVIK REDDY	IV	15	PASS
66	17D91A0324	SADUVULA DEVENDER	IV	17	PASS
67	17D91A0325	SAMALLA DIVAKAR	IV	15	PASS

 PRINCIPAL
MAHAVEER
 INSTITUTE OF SCIENCE & TECHNOLOGY
 HYDERABAD-500 005

Venkatpur, Bandlaguda Post, Keesara
Hyderabad-505 001, Telangana INDIA
Tel: 040-64896979, 20020773, Fax: 040-24455003
E-mail: principal.mahaveer@gmail.com
Website: www.mst.ac.in

MAHAVEER



Approved by AICTE Affiliated to JNTUHYD

68	17E99A0330	VOONAL A ADHIYA	IV	16	PASS
69	18E99A0301	DEERA PRAVEEN KUMAR	IV	16	PASS
70	18E99A0303	GADU A SANGELTHI KUMAR	IV	15	PASS
71	18E99A0305	M ASHWINKANTH	IV	17	PASS
72	18E99A0306	MANDAPELLI SRIKANTH	IV	15	PASS
73	18E99A0307	MOOD HATHBRAM	IV	16	PASS
74	18E99A0310	SARE SRIKANTH	IV	16	PASS
75	17E35A0307	K SURESH	IV	16	PASS

PRINCIPAL
MAHAVEER
INSTITUTE OF TECHNOLOGY
HYD



ANSYS COURSE Summary

Department of Mechanical Engineering

1.The Geometry preparation training course is for users who want to create and modify geometry in preparation for CFD or FEA analysis. The training will be focused in either ANSYS Design Modeler or ANSYS Space Claim.

2. The ANSYS Meshing training course will give you the tools for generating good quality meshes for Fluent andCFX. The trainee will choose which tool should be used: ANSYS Meshing, Fluent Meshing or ICFM CFD

3. This course will show how to set up a range of simulation types in the ANSYS Fluent or ANSYS CFX solver, aswell as how to post process the results by using our CFD Post Tool.

4. This course will show how to set up a range of simulation types in ANSYS Mechanical, as well as how to post process and evaluate your results.

5. To acquire advance knowledge to perform explicit simulations with ANSYS Explicit STR, ANSYS AUTODYN or ANSYS LS-DYNA

6. This is an introductory to intermediate level training for using ANSYS HFSS for all applications, like RF/microwave, antennas or planar problems. Participants will get understanding of HFSS modeling, solution process and post-processing features, which can be used for other advanced applications. The course will also cover advanced topics like dynamic link between EM and circuit, impedance matching, overview of HFSS 3Dlayout interface and speeding-up HFSS simulation using HPC.

7. Provide the needed tools for the complete simulation of a pressure Vessel from scratch. Several types of analysis and boundary conditions will be discussed, by using pressure vessels examples.

8.To acquire advance knowledge for performing mechanical simulation in Fixed Offshore Structures.

Copy to :

1.Department of Notice Board

2.Principal for Information

3.Committe Members(Academic)

Venugopal, Bandlaguda Post, Keshavnagar,
Hyderabad 500 005, Telangana INDIA
Tel: 040-44596579, 20020775, Fax: 040-24455003
E-mail: principal@mahaveer@gmail.com
Website: www.mahaveer.ac.in

MAHAVEER



Approved by AICTE, Affiliated to JNTUHT Hyd

CERTIFICATE OF COURSE COMPLETION

This certificate is presented to D. Prathap of
MIST, who has successfully completed technical training course on
"ANSYS" held from 06-01-2020 to 18-01-2020 and found the
student performance to be excellent.



ESTD : 2001

B.N.R.
Dr. B. Nageswar Rao

HOD

Department of Mechanical Engineering

[Signature]
DR. B. NAGESWAR RAO
HOD
DEPT. OF MECHANICAL ENGINEERING
MAHAVEER INSTITUTE OF SCIENCE & TECHNOLOGY
VENUGOPAL, BANDLAGUDA POST, KESHAVNAGAR,
HYDERABAD - 500 005, TELANGANA, INDIA



DEPARTMENT OF MECHANICAL ENGINEERING

List of students enrolled in ANSYS (2020-2021)

S.No	Roll No	Name of the student	Date	11/10/20	12/10/20	13/10/20	14/10/20	15/10/20	16/10/20	17/10/20	18/10/20	19/10/20	20/10/20	21/10/20	22/10/20	23/10/20	24/10/20	25/10/20
1	17E31A0301	AILNENI HARSHITH	P	P	P	P	P	P	P	P	P	P	P	P	P	P	P	P
2	17E31A0302	ALLA RAJA	P	P	P	P	P	P	P	P	P	P	P	P	P	P	P	P
3	17E31A0304	BANGARI MOHAN	P	P	P	P	P	P	P	P	P	P	P	P	P	P	P	P
4	17E31A0305	BASANOLA JAYVARDHAN	P	P	P	P	P	P	P	P	P	P	P	P	P	P	P	P
5	17E31A0306	BEJANKI MAHESH REDDY	P	P	P	P	P	P	P	P	P	P	P	P	P	P	P	P
6	17E31A0308	DANDU SANJEEV	P	P	P	P	P	P	P	P	P	P	P	P	P	P	P	P
7	17E31A0309	DEPA JAYANDER REDDY	P	P	P	P	P	P	P	P	P	P	P	P	P	P	P	P
8	17E31A0311	G ABHILASHI REDDY	P	P	P	P	P	P	P	P	P	P	P	P	P	P	P	P
9	17E31A0313	GUGGILLA VENKAT SAI	P	P	P	P	P	P	P	P	P	P	P	P	P	P	P	P
10	17E31A0314	GUNNAM VENKATA LAKSHMI AKHILA	P	P	P	P	P	P	P	P	P	P	P	P	P	P	P	P
11	17E31A0316	KANNA MANIKANTA	P	P	P	P	P	P	P	P	P	P	P	P	P	P	P	P
12	17E31A0320	KONDURU PAVAN KUMAR	P	P	P	P	P	P	P	P	P	P	P	P	P	P	P	P

About the College

As an Institute committed in quality education, MIST aims at providing learning with a Technology- edge. It endeavors to provide consistent training to its students to help them evolve as competent professionals in the highly competitive world. Right from its inception in 2001, it has been tuning itself to meet this objective. A new civilization is emerging in our lives. This civilization brings with it a new way of working. Millions are already tuning their lives to the rhythms of tomorrow.

About the Mechanical Dept.

The Mechanical engineering is one of the core engineering departments, which has potential to accommodate all efficient engineers. The Mechanical engineers serve all other branches of engineering directly or indirectly. The Mechanical engineers can find their place in Automobile engineering sector, Steel Plants, Power plants, Software industries, Manufacturing industries, Design industries, Military, Naval and Air force, Defense research organizations, Material research organizations etc.

About the Workshop

3D printing is used by designers for more than 30 years as a prototyping tool to reduce the product realization time. In the last decade it gained attraction as an inevitable manufacturing technology for various fields such as Defence, Medical, Aerospace and Automobile. The versatility of 3D printers is evident in variety of ways they are used today. It has the potential to democratize the production of components, and goods from food to medical supplies. In future, 3D printing machines could make their way into homes and offices.

Organizing committee

CHIEF PATRON

Smt. S. Jayalakshmi Reddy

Chairman

Sri. S. Surendar Reddy

Secretary

Sri S. Dhanunjay Reddy

Joint Secretary

DIRECTOR

Dr. H. S. N. Murthy

PATRON

Dr B.V.Sanker Ram. Principal

CONVENER

Mr.B.Venkateswar Reddy,

Asso. Prof, Dept. Of Mechanical

PROGRAM COORDINATORS

Mr. D.Santhosh Kumar

Duration

11-06-2020 to 23-06-2020

MAHAVEER

INSTITUTE OF SCIENCE & TECHNOLOGY

Approved by AICTE, Affiliated to JNTU, Hyderabad.

Visvesvaraya Road, Mahaveer, Hyderabad-500005.



Two week
Certification Course
on

Introduction to 3D Printing

Organized by

Department of Mechanical
Engineering

Vyasavri, Bandlaguda Post: Keshavnagar,
Hyderabad-500 005, Telangana INDIA
Tel: 040-54550979, 10020773, Fax: 040-24455002
E-mail: principal@mahaveer2@gmail.com,
Website: www.mira.ac.in

MAHAVEER



Approved by AICTE. Affiliated to JNTU H of T

Date: 01-06-2020

To
The Principal
MIST,
Hyderabad.

Sub: Proposal for Add-on Course-Reg.

Respected sir,

We are going to conduct 10 days Technical Training for IV B. Tech students on
"Introduction to 3D-Printing". We require your approval to go head for proceeding and hope to
get an opportunity to serve you the best.

With thanks and regards

~~B.VENKATESWAR REDDY~~

HOD

Department of Mechanical Engineering

PRINCIPAL
MAHAVEER
INSTITUTE OF SCIENCE & TECHNOLOGY
Bandlaguda, Hyo-500 005.



Date: 02.06.2020

CIRCULAR

Technical Training for IV B. Tech students are starting from 11th June, 2020 onwards. All HODs and Placements coordinators have to manage the trainings and ensure 95% attendance all through the sessions.

All Mentors need to send the compiled feedback report to B.Venkateswar Reddy, HOD at e3hod.mech@gmail.com daily.

Agenda: 1. Introduction to 3D-Printing.

Design and Development of curriculum for Add on course:

Name of the Faculty : 1. D.SANTHOSH KUMAR

B.VENKATESWAR REDDY

HOD

Department of Mechanical Engineering

PRINCIPAL
MAHAVEER
INSTITUTE OF SCIENCE & TECHNOLOGY
BANDLAGUDA, HYDRABAD-500005.



3D PRINTING SYLLABUS

Department of Mechanical Engineering

DURATION -30 (Hours)

- 1.Introduction to 3D Printing
- 2.Learning Objectives
- 3.What is a Mesh?
- 4.3D Printing Types
- 5.Why 3D Printing?
- 6.3D Printing Limitations Uses in Industry
- 7.Getting 3D Printable Files
- 8.Downloading Models Downloading Tips
- 9.Gear Systems Part I
- 10.Gear Systems Part II
- 11.Dynamic Surfaces and Chains
- 12.Preparing Files for 3D Printing Model
- 13.Orientation Support Material Print Bed
- 14.Prototype Printing
- 15.Prototype Printing & Testing
- 16.Final Presentations
- 17.Sound Printing
- 18.Fluid Dynamics
- 19.Post-Processing

PRINCIPAL

MAHAVEER

INSTITUTE OF TECHNOLOGY
KESHAVNAGAR, HYDERABAD - 500 605



Department of Mechanical Engineering 3D-PRINTING Machine Training, student attendance list 2020-21

SL.NO.	ROLL NO.	NAME OF THE STUDENT	YEAR
1	17E31A0301	AILNENI HARSHITH	IV
2	17E31A0302	ALLA RAJA	IV
3	17E31A0304	BANGARI MOHAN	IV
4	17E31A0305	BASANOLA JAYVARDHAN	IV
5	17E31A0306	BEJJANKI MAHESH REDDY	IV
6	17E31A0308	DANDU SANJEEV	IV
7	17E31A0309	DEPA JAYANDER REDDY	IV
8	17E31A0311	G ABHILASH REDDY	IV
9	17E31A0313	GUGGILLA VENKAT SAI	IV
10	17E31A0314	GUNNAM VENKATA LAKSHMI AKHILA	IV
11	17E31A0316	KANNA MANIKANTA	IV
12	17E31A0320	KONDURU PAVAN KUMAR	IV
13	17E31A0322	M A GHOUSE	IV
14	17E31A0324	MALLETHULA RAHUL	IV
15	17E31A0325	MALLISETTI PREM SAI	IV
16	17E31A0326	MANGILGI MAHESH	IV
17	17E31A0327	MANKENA PRUDHVIRAJ	IV
18	17E31A0328	MD ARMAN	IV
19	17E31A0333	MOHAMMED RAYEES	IV
20	17E31A0339	NALLAMPALLY SRIKANTH REDDY	IV
21	18E35A0301	AKULA GIRIDHAR YADAV	IV
22	18E35A0302	AYIDALAPALLY SHYAM KUMAR	IV
23	18E35A0303	B CHANDRA SEKHAR	IV
24	18E35A0305	BASUDE SAGAR	IV
25	18E35A0306	BOLLAM NARESH	IV
26	18E35A0307	CH RAJU	IV
27	18E35A0308	CHINNABOSKA MAHESH	IV
28	18E35A0309	CHINNAPAGU SWETHA	IV
29	18E35A0310	DODLA PRATHAP	IV
30	18E35A0311	G UMA MAHESHWARI	IV

PRINCIPAL
MAHAVEER
Engineering College
Vysavuri, Bandlaguda, Hyd-500 005

Vysapuri, Bandlaguda Post, Keshavnagar
Hyderabad-500 005, Telangana INDIA
Tel: 040-64596979, 20020773, Fax: 040-24455003
E-mail: principal.mahaveer@gmail.com
Website: www.must.ac.in

MAHAVEER



Approved by AICTE, Affiliated to JNTUH Hyd

31	18E35A0312	GOKA SAIKRISHNA	IV
32	16M31A0322	TELUSRI AJAY	IV
33	17M31A0306	SYED MOHAMMED FAIZAN GHORI	IV
34	18M35A0308	MOHD FIRASATH ALI	IV
35	16E31A0330	PUTTAPAD YADAI AH	IV
36	17E35A0317	P TARUN KUMAR	IV
37	16E31A0333	R HEMANTH KUMAR	IV
38	17E31A0342	P BHARGAV KUMAR	IV
39	17E31A0343	PILLI AKHIL BABU	IV
40	17E31A0344	POLNENI SAITEJA	IV
41	17E31A0346	RUDRARAJU DEEPANKAR SARAVANA VARMA	IV
42	17E31A0348	SATHYAPRASAD POOJA	IV
43	17E31A0352	SHAIKH FAIZAN RAZA	IV
44	17E31A0354	SHARAVAN SUTHAR	IV
45	17E31A0355	T BUNNY	IV
46	17E31A0360	YADAMA SATHISH REDDY	IV
47	18E35A0313	GUDA VIKAS	IV
48	18E35A0314	JALUKURI RAM MURTHI	IV
49	18E35A0315	KANDE VINEETH	IV
50	18E35A0317	MADUGULA GOPALA KRISHNA	IV
51	18E35A0318	MEGAVATH MAHIPAL	IV
52	18E35A0321	NITIN MAHENDRAKAR	IV
53	18E35A0322	NUNAVATH LINGAM	IV
54	18E35A0323	RAPOLU SRIKANTH	IV
55	18E35A0324	THOTLA MAHENDER	IV
56	18E35A0325	V PRANEESH	IV
57	16621A0316	SYED ABUBAKAR	IV
58	17D91A0303	AMPALLY NITHIN KUMAR	IV
59	17D91A0304	BAROOR ARVIND REDDY	IV
60	17D91A0307	DESANI SANDEEP REDDY	IV
61	17D91A0308	DIDDI ROSHAN SAI	IV
62	17D91A0309	GOLKONDA NITHISH YADAV	IV
63	17D91A0311	GUNTUKA RAMBABU	IV
64	17D91A0316	MOHAMMAD IRFAN	IV
65	17D91A0320	MULA SATHVIK REDDY	IV
66	17D91A0324	SADUVULA DEVENDER	IV
67	17D91A0325	SAMALLA DIVAKAR	IV
68	17D91A0330	VODNALA ADITHYA	IV

MAHAVEER
Principal
Vysapuri, Bandlaguda Post, Keshavnagar
Hyderabad-500 005, Telangana INDIA

Vysapuri, Bandlaguda Post, Keshavnagar,
Hyderabad-500 005, Telangana INDIA
Tel: 040-64596979, 20026773, Fax: 040-24455003
E-mail: principal.mahaveer@gmail.com,
Website: www.mist.ac.in,

MAHAVEER



Approved by AICTE, Affiliated to JNTUH Hyd

69	18D95A0301	BEERA PRAVEEN KUMAR	IV
70	18D95A0303	GAJULA SANGEETH KUMAR	IV
71	18D95A0305	M ASHWINKANTH	IV
72	18D95A0306	MANDAPELLI SRIKANTH	IV
73	18D95A0307	MOOD HATHIRAM	IV
74	18D95A0310	SARE SRIKANTH	IV
75	17E35A0307	K SURESH	IV

Principal
Date: 12/12/2019
Page No: 207



Technical Training Exam on 3D-Printing
(A.Y-2020-21)

Department of Mechanical Engineering

2x10=20 Marks

Answer All the Questions

Answer All the Questions 5x4=20 Marks

1. Compare the Third Industrial Revolution to the First Industrial Revolution. What are the differences and similarities?
2. Explain what design freedom means and how 3D printing contributes to it. Which technology would provide the best basis for food printing? Why?
3. Explain the following: "A mesh can never be smooth."
 - a) Describe the relationship between resolution and mesh smoothness.
 - b) Describe the relationship between mesh smoothness and file size.
 - c) What can be learned by studying the designs of others?
4. Describe the advantages of designing an object using 3D software instead of 2D software.
 - a) Describe the advantages of 2D software over hand sketches.
 - b) Explain the role of CAM software in the printing process. Why is it needed?
5. Describe the unique considerations involved when designing a gear system for 3D printing.

PRINCIPAL
M. MAHAVEER
MIST
Bandlaguda Post, Hyderabad-500 005.

Vysavuri, Bandlaguda Post, Keeravathi,
Hyderabad 500 005, Telangana INDIA
Tel: 040-64556979, 20020773, Fax: 040-24455093
E-mail: principal.mahaveer@gmail.com
Website: www.mst.ac.in

MAHAVEER



Approved by AICTE, Affiliated to JNTU K Hyd

Department of Mechanical Engineering
3D PRINTING Machine Training ,student attendance list 2020-21

S.NO	Roll No	Name of the student	YEAR	MARKS	PASS/FAIL
1	17E31A0301	AILNENI HARSHITHI	IV	15	PASS
2	17E31A0302	ALLA RAJA	IV	16	PASS
3	17E31A0304	BANGARI MOHAN	IV	18	PASS
4	17E31A0305	BASANOLA JAYVARDHAN	IV	15	PASS
5	17E31A0306	BEJANKI MAHESH REDDY	IV	15	PASS
6	17E31A0308	DANDU SANJEEV	IV	15	PASS
7	17E31A0309	DEPA JAYANDER REDDY	IV	16	PASS
8	17E31A0311	G ABHILASH REDDY	IV	15	PASS
9	17E31A0313	GUGGILLA VENKAT SAI	IV	16	PASS
10	17E31A0314	GUNNAM VENKATA LAKSHMI AKHILA	IV	12	PASS
11	17E31A0316	KANNA MANIKANTA	IV	14	PASS
12	17E31A0320	KONDURU PAVAN KUMAR	IV	16	PASS
13	17E31A0322	M A GHOUSE	IV	12	PASS
14	17E31A0324	MALLETHULA RAHUL	IV	15	PASS
15	17E31A0325	MALLISETTI PREM SAI	IV	16	PASS
16	17E31A0326	MANGILGI MAHESH	IV	14	PASS
17	17E31A0327	MANKENA PRUDHVIRAJ	IV	15	PASS
18	17E31A0328	MD ARMAN	IV	17	PASS
19	17E31A0333	MOHAMMED RAYEES	IV	15	PASS
20	17E31A0339	NALLAMPALLY SRIKANTH REDDY	IV	16	PASS
21	18E35A0301	AKULA GIRIDHAR YADAV	IV	16	PASS
22	18E35A0302	AYIDALAPALLE SHYAM KUMAR	IV	15	PASS
23	18E35A0303	B CHANDRA SEKHAR	IV	16	PASS
24	18E35A0305	BASUDE SAGAR	IV	12	PASS
25	18E35A0306	BOLLAM NARESH	IV	15	PASS
26	18E35A0307	CH RAJU	IV	16	PASS
27	18E35A0308	CHINNABOSKA MAHESH	IV	14	PASS
28	18E35A0309	CHINNAPAGU SWETHA	IV	15	PASS
29	18E35A0310	DODLA PRATHAP	IV	17	PASS
30	18E35A0311	G UMA MAHESHWARI	IV	15	PASS
31	18E35A0312	GOKA SAIKRISHINA	IV	16	PASS
32	16M31A0322	TELUSRI AJAY	IV	16	PASS

(Signature)
Principal
Mahaveer Institute of Technology and Engineering
Vysavuri, Bandlaguda Post, Keeravathi,
Hyderabad 500 005, Telangana INDIA

Vysampati, Bandlaguda Post, Keshavnagar,
Hyderabad-500 025, Telangana INDIA
Tel: 040-64396979/20020173, Fax: 040-24455093
E-mail: principal.mahaveer@gmail.com
Website: www.mist.ac.in

MAHAVEER

Approved by AICTE. Affiliated to JNTUHYD



33	17M31A0306	SYED MOHAMMAD FAIZAN GHORI	IV	15	PASS
34	18M35A0308	MOHD FIRASATH ALI	IV	17	PASS
35	16E31A0330	PUTTAPAD YADAJAH	IV	15	PASS
36	17E35A0317	P TARUN KUMAR	IV	16	PASS
37	16E31A0333	R HEMANTH KUMAR	IV	16	PASS
38	17E31A0342	P BHARGAV KUMAR	IV	15	PASS
39	17E31A0343	PILLI AKHIL BABU	IV	16	PASS
40	17E31A0344	POLNENI SAITEJA	IV	16	PASS
41	17E21A0346	RUDRARAJU DEEPANKAR SARAVANA VARMA	IV	15	PASS
42	17E31A0348	SATHYAPRASAD POOJA	IV	16	PASS
43	17E31A0352	SHAIKH FAIZAN RAZA	IV	12	PASS
44	17E31A0354	SHARAVAN SUTHAR	IV	15	PASS
45	17E31A0355	T BUNNY	IV	16	PASS
46	17E31A0360	YADAMA SATHISH REDDY	IV	14	PASS
47	18E35A0313	GUDA VIKAS	IV	15	PASS
48	18E35A0314	JALUKURI RAM MURTHI	IV	17	PASS
49	18E35A0315	KANDE VINEETHI	IV	15	PASS
50	18E35A0317	MADUGULA GOPALA KRISHNA	IV	16	PASS
51	18E35A0318	MEGAVATH MAHIPAL	IV	16	PASS
52	18E35A0321	NITIN MAHENDRAKAR	IV	15	PASS
53	18E35A0322	NUNAVATH LINGAM	IV	17	PASS
54	18E35A0323	RAPOLU SRIKANTH	IV	15	PASS
55	18E35A0324	THOTLA MAHENDER	IV	16	PASS
56	18E35A0325	V PRANEESH	IV	16	PASS
57	16E21A0316	SYED ABU BAKAR	IV	16	PASS
58	17D91A0303	AMPALLY NITHIN KUMAR	IV	16	PASS
59	17D91A0304	BAROOR ARVIND REDDY	IV	14	PASS
60	17D91A0307	DESANI SANDEEP REDDY	IV	16	PASS
61	17D91A0308	DIDDI ROSHAN SAI	IV	12	PASS
62	17D91A0309	GOLKONDA NITHISH YADAV	IV	15	PASS
63	17D91A0311	GUNTUKA RAMBABU	IV	16	PASS
64	17D91A0316	MOHAMMAD IRFAN	IV	14	PASS
65	17D91A0320	MULA SATHVIK REDDY	IV	15	PASS
66	17D91A0324	SADUVULA DEVENDER	IV	17	PASS
67	17D91A0325	SAMALLA DIVAKAR	IV	15	PASS



MAHAVEER
INSTITUTE OF TECHNOLOGY
Bandlaguda, Hyderabad-500 025.

Vysapuri, Bandlaguda Post, Keshavnagar,
Hyderabad-500 005, Telangana, INDIA
Tel: 040-64556979, 20020773, Fax: 040-24451003
E-mail: principal.mahaveer@gmail.com,
Website: www.mst.ac.in

MAHAVEER



Approved by AICTE. Affiliated to JNTU/H Hyderabad

68	17D91A0330	VODNALA ADITHYA	IV	16	PASS
69	18D95A0301	BETRA PRAVEEN KUMAR	IV	16	PASS
70	18D95A0303	GAJULA SANGEETH KUMAR	IV	15	PASS
71	18D95A0305	M ASHWINKANTH	IV	17	PASS
72	18D95A0306	MANDAPELLI SRIKANTH	IV	15	PASS
73	18D95A0307	MOOD HATHIRAM	IV	16	PASS
74	18D95A0310	SARE SRIKANTH	IV	16	PASS
75	17E35A0307	K SURESH	IV	16	PASS

Principal
Mahaveer Institute of Technology
Bandlaguda, Hyderabad-500 005



3D-PRINTING COURSE

Summary

Department of Mechanical Engineering

1. 3D Printing uses software that slices the 3D model into layers (0.01mm thick or less in most cases). Each layer is then traced onto the build plate by the printer, once the pattern is completed, the build plate is lowered and the next layer is added on top of the previous one.

2. Layer by layer production allows for much greater flexibility and creativity in the design process. No longer do designers have to design for manufacture, but instead they can create a part that is lighter and stronger by means of better design. Parts can be completely re-designed so that they are stronger in the areas that they need to be and lighter overall.

3. 3D Printing significantly speeds up the design and prototyping process. There is no problem with creating one part at a time, and changing the design each time it is produced. Parts can be created within hours. Bringing the design cycle down to a matter of days or weeks compared to months. Also, since the price of 3D printers has decreased over the years, some 3D printers are now within financial reach of the ordinary consumer or small company.

4. Typical manufacturing techniques are known as 'Subtractive Manufacturing' because the process is one of removing material from a preformed block. Processes such as Milling and Cutting are subtractive manufacturing techniques. This type of process creates a lot of waste since the material that is cut off generally cannot be used for anything else and is simply sent out as scrap.

Copy to :

1. Department of Notice Board
2. Principal for Information
3. Committee Members(Academic)

Principal
Department of Mechanical Engineering
Vysapur, Bonduguda, Hyderabad-500 025.

Vysapuri, Bandlaguda Post Keshavnagar,
Hyderabad-500 055, Telangana INDIA
Tel: 040 64596979, 20020773, Fax: 040 24485003
E-mail: principal.mahaveer@gmail.com,
Website: www.mist.ac.in.

MAHAVEER



Approved by AICTE. Affiliated to JNTU Hyderabad

CERTIFICATE OF COURSE COMPLETION

This certificate is presented to T. Bunny of MIST,
who has successfully completed technical training course on "3D
PRINTING" held from 11-06-2020 to 23-06-2020 and found the
student performance to be excellent.



ESTD : 2001

HOD

B. VENKATESWAR REDDY

Department of Mechanical Engineering

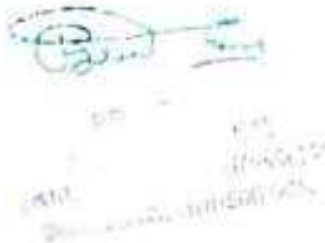



DEPARTMENT OF MECHANICAL ENGINEERING

List of students enrolled in 3D-Printing (2020-2021)

S.No	Roll No	Name of the student	11/1/20	12/06/20	15/06/20	16/06/20	17/06/20	18/06/20	19/06/20	20/06/20	21/06/20	22/06/20	23/06/20	24/06/20
1	17E31A0301	ALNENI HARSHITH	P	P	P	P	P	P	P	P	P	P	P	P
2	17E31A0302	ALLARAJA	P	P	P	P	P	P	P	P	P	P	P	P
3	17E31A0304	BANGARI MOHAN	P	P	P	P	P	P	P	P	P	P	P	P
4	17E31A0305	BASANOLA JAYVARDHAN	P	P	P	P	P	P	P	P	P	P	P	P
5	17E31A0306	BEJANKI MAHESH REDDY	P	P	P	P	P	P	P	P	P	P	P	P
6	17E31A0308	DANDU SANJEEV	P	P	P	P	P	P	P	P	P	P	P	P
7	17E31A0309	DEPA JAYANDER REDDY	P	P	P	P	P	P	P	P	P	P	P	P
8	17E31A0311	G ABHILASHI REDDY	P	P	P	P	P	P	P	P	P	P	P	P
9	17E31A0313	GUGGILLA VENKAT SAI	P	P	P	P	P	P	P	P	P	P	P	P

 Principal

DEPARTMENT OF MECHANICAL ENGINEERING

List of students enrolled in 3D-Printing (2020-2021)

S.No	Roll No	Name of the student	11/06/2020	12/06/2020	15/06/2020	16/06/2020	17/06/2020	18/06/2020	19/06/2020	20/06/2020	23/06/2020
19	17E31A0333	MOHAMMED RAYEES	P	P	P	P	P	P	P	P	P
20	17E31A0339	NALLAMPALLY SRIKANTHI REDDY	P	P	P	P	P	P	P	P	P
21	18E35A0301	AKULA GIRIDHAR YADAV	P	P	P	P	P	P	P	P	P
22	18E35A0302	AYIDALAPALLY SHYAMKUNJAR	P	P	P	P	P	P	P	P	P
23	18E35A0303	B CHANDRA SEKHAR	P	P	P	P	P	P	P	P	P
24	18E35A0305	BASUDE SAGAR	P	P	P	P	P	P	P	P	P
25	18E35A0306	BOLLAM NARESH	P	P	P	P	P	P	P	P	P
26	18E35A0307	CHIRAJU	P	P	P	P	P	P	P	P	P
27	18E35A0308	CHINNABOSKA MAHESH	P	P	P	P	P	P	P	P	P



DEPARTMENT OF MECHANICAL ENGINEERING

List of students enrolled in 3D-Printing (2020-2021)

S.No	Roll No	Name of the student	04/2020	12/2020	15/2020	16/2020	17/2020	18/2020	19/2020	20/2020	21/2020	22/2020	23/2020
37	16E31A0333	R HEMANTH KUMAR	P	P	P	P	P	P	P	P	P	P	P
38	17E31A0342	P BHARGAV KUMAR	P	P	P	P	P	P	P	P	P	P	P
39	17E31A0343	PILLI AKHIL BABU	P	P	P	P	P	P	P	P	P	P	P
40	17E31A0344	POLNENI SAITEJA	P	P	P	P	P	P	P	P	P	P	P
41	17E31A0346	RUDRARAJU DEEPANKAR SARAVANA VARMA	P	P	P	P	P	P	P	P	P	P	P
42	17E31A0348	SATHYAPRASAD POOJA	P	P	P	P	P	P	P	P	P	P	P
43	17E31A0352	SHAIKH FAIZAN RAZA	P	P	P	P	P	P	P	P	P	P	P
44	17E31A0354	SHARAVAN SUTHAR	P	P	P	P	P	P	P	P	P	P	P
45	17E31A0355	T BUNNY	P	P	P	P	P	P	P	P	P	P	P

Principal
 Mahaveer Institute of Engineering and Technology



DEPARTMENT OF MECHANICAL ENGINEERING

List of students enrolled in 3D-Printing (2020-2021)

S.No	Roll No	Name of the student	11/06/2020	12/06/2020	15/06/2020	16/06/2020	17/06/2020	19/06/2020	19/06/2020	20/06/2020	22/06/2020	23/06/2020
46	17E31A0360	YADAMA SATHISH REDDY	P	P	P	P	P	P	P	P	P	P
47	18E35A0313	GUDA VIKAS	P	P	P	P	P	P	P	P	P	P
48	18E35A0314	JALUKURI RAM MURTHI	P	P	P	P	P	P	P	P	P	P
49	18E35A0315	KANDE VINEETH	P	P	P	P	P	P	P	P	P	P
50	18E35A0317	MADUGULA GOPALA KRISHNA	P	P	P	P	P	P	P	P	P	P
51	18E35A0318	MEGAVATHI MAHPAL	P	P	P	P	P	P	P	P	P	P
52	18E35A0321	NITIN MAHENDRAKAR	P	P	P	P	P	P	P	P	P	P
53	18E35A0322	NUNAVATHI LINGAM	P	P	P	P	P	P	P	P	P	P
54	18E35A0323	RAPOLU SRIKANTHI	P	P	P	P	P	P	P	P	P	P

Pandit Sir



DEPARTMENT OF MECHANICAL ENGINEERING

List of students enrolled in 3D-Printing (2020-2021)

S.No	Roll No	Name of the student	14/01/2020	15/01/2020	16/01/2020	17/01/2020	18/01/2020	19/01/2020	20/01/2020	21/01/2020	22/01/2020	23/01/2020
55	18E35A0324	THOTLA MAHENDER	P	P	P	P	P	P	P	P	P	P
56	18E35A0325	V PRANEESH	P	P	P	P	P	P	P	P	P	P
57	16621A0316	SYED ABUBAKAR	P	P	P	P	P	P	P	P	P	P
58	17D91A0303	AMPALLY NITHIN KUNJAR	P	P	P	P	P	P	P	P	P	P
59	17D91A0304	BAROOR ARVIND REDDY	P	P	P	P	P	P	P	P	P	P
60	17D91A0307	DESANI SANDEEP REDDY	P	P	P	P	P	P	P	P	P	P
61	17D91A0308	DIDDI ROSHAN SAI	P	P	P	P	P	P	P	P	P	P
62	17D91A0309	GOLKONDA NITHISH YADAV	P	P	P	P	P	P	P	P	P	P
63	17D91A0311	GUNTUKA RAMBABU	P	P	P	P	P	P	P	P	P	P
64	17D91A0316	MOHAMMAD IRFAN	P	P	P	P	P	P	P	P	P	P

(Handwritten signature and date)



DEPARTMENT OF MECHANICAL ENGINEERING

List of students enrolled in 3D-Printing (2020-2021)

S.No	Roll No	Name of the student	11/04/2020	17/06/2020	15/06/2020	11/06/2020	17/06/2020	10/06/2020	09/06/2020	20/06/2020	23/06/2020
65	17D91A0320	MULA SATHVIK REDDY	P	P	P	P	P	P	P	P	P
66	17D91A0324	SADUVULA DEVENDER	P	P	P	P	P	P	P	P	P
67	17D91A0325	SAMALLA DIVAKAR	P	P	P	P	P	P	P	P	P
68	17D91A0330	VODNALA ADITHYA	P	P	P	P	P	P	P	P	P
69	18D95A0301	BEERA PRAVEEN KUMAR	P	P	P	P	P	P	P	P	P
70	18D95A0303	GAJULA SANGEETH KUMAR	P	P	P	P	P	P	P	P	P
71	18D95A0305	M ASHWINKANTH	P	P	P	P	P	P	P	P	P
72	18D95A0306	MANDAPELLI SRIKANTH	P	P	P	P	P	P	P	P	P
73	18D95A0307	MOOD HATHIRAM	P	P	P	P	P	P	P	P	P

(Signature)



MAHAVEER

Engineering College

Hyderabad, Dist: Rangareddy, Pin: 501301
Tel: 040-8455009, 89, 20003773, 424, 344, 4455000
E-mail: info@mahaveerengg.ac.in
Website: www.mahaveerengg.ac.in

DEPARTMENT OF MECHANICAL ENGINEERING

List of students enrolled in 3D-Printing (2020-2021)

S.No	Roll No	Name of the student	Date	18/06/20	18/07/20	18/08/20	18/09/20	18/10/20	18/11/20	18/12/20	19/01/21	19/02/21	19/03/21
74	18D95A0310	SARE SRINANTHI	P	P	P	P	P	P	P	P	P	P	P
75	17E35A0307	K.SURESH	P	P	P	P	P	P	P	P	P	P	P

(Handwritten signature and date)
 Date: 18/03/2021
 Signature: [Handwritten]

About the College

As an Institute committed in quality education, MIST aims at providing learning with a Technology-edge. It endeavors to provide consistent training to its students to help them evolve as competent professionals in the highly competitive world. Right from its inception in 2001, it has been tuning itself to meet this objective. A new civilization is emerging in our lives. This civilization brings with it a new way of working. Millions are already tuning their lives to the rhythms of tomorrow.

About the Mechanical Dept.

The Mechanical engineering is one of the core engineering departments, which has potential to accommodate all efficient engineers. The Mechanical engineers serve all other branches of engineering directly or indirectly. The Mechanical engineers can find their place in Automobile engineering sector, Steel Plants, Power plants, Software industries, Manufacturing industries, Design industries, Military, Naval and Air force, Defense research organizations, Material research organizations etc.

About the Workshop

This course will make one familiar with the operating process, manual programming, computer assisted programming, tool & work setting and Product machining. Manufacturing trend has made a quantum leap towards CNC (Computer Numerical Control) from conventional methods. Industry is in great need of professionals with thorough CNC Programming knowledge in India and Abroad. CTC a newly started state-of-the-art training centre, offers high end training in cnc programming and cnc machining.

Organising committee

CHIEF PATRON

Smt. S. Jayalakshmi Reddy

Chairman

Sri. S. Surendar Reddy

Secretary

Sri S. Dhanunjay Reddy

Joint Secretary

DIRECTOR

Dr. H. S. N. Murthy

PATRON

Dr B.V.Sanker Ram.Principal

CONVENER

Mr.B.Venkateswar Reddy,

Asso.Prof, Dept. Of Mechanical

PROGRAM COORDINATORS

Mr. Manil

K.Devi Singh

Duration

03-02-2020 to 13-02-2020



MAHAVEER

INSTITUTE OF SCIENCE & TECHNOLOGY

Approved by AICTE, Affiliated to JNTU, Hyderabad.
Vengal Rao, Barakheda, Post: Westorchy, Hyderabad-500009.



**Two week
Certification Course
on**

Introduction to CNC Programming

Organized by

**Department of Mechanical
Engineering**



DEPARTMENT OF MECHANICAL ENGINEERING

Date: 31-01-2020

To
The Principal
MIST,
Hyderabad.

Sub: Proposal for Add-on Course-Reg.

Respected sir,

We are going to conduct 10 days Technical Training for II B Tech students on "Introduction to CNC Programming", We require your approval to go ahead for proceeding and hope to get an opportunity to serve you the best.

With thanks and regards

HOD

B.VENKATESWAR REDDY

Department of Mechanical Engineering

PRINCIPAL
MIST
Mysore Engineering College
Hyderabad, Telangana



DEPARTMENT OF MECHANICAL ENGINEERING

Date: 01.02.2020

CIRCULAR

Technical Training for II B. Tech students are starting from 3rd February, 2020 onwards. All HODs and Placements coordinators have to manage the trainings and ensure 95% attendance all through the sessions.

All Mentors need to send the compiled feedback report to B.Venkateswar Reddy, HOD at e3hod.mech@gmail.com daily.

Agenda: 1. Introduction to CNC Programming.

Design and Development of curriculum for Add on course:

Name of the Faculty : I.M.Anil

PRINCIPAL
MAHAVEER
INSTITUTE OF SCIENCE & TECHNOLOGY
Bandlaguda, Hyd-500 005.

HOD 
B.VENKATESWAR REDDY
Department of Mechanical Engineering



DEPARTMENT OF MECHANICAL ENGINEERING

SYLLABUS FOR CNC PROGRAMMING

Department of Mechanical Engineering

(Hours)-30

- 1.CNC production philosophy and equipment
- 2.Coordinate systems – cartesian and polar
- 3.Absolute and incremental movement
- 4.Cutting speeds for milling and drilling
5. Drawing basic stock shapes using geometric methods
- 6.Adding features to the stock
- 7.Generating tool paths
- 8.Generating G-code from the tool paths
- 9.Mill operation.
- 10.Profile Checking

PRINCIPAL

INSTITUTION

Bandlaguda, Hyderabad



DEPARTMENT OF MECHANICAL ENGINEERING

Department of Mechanical Engineering
 CNC Technical Training student attendance list 2020-21

SL.NO.	ROLL NO.	NAME OF THE STUDENT	YEAR
1	19E31A0301	ABDUL QUADAR BIN ABDUL BARI	II
2	20E35A0306	S ROHIT	II
3	19E31A0303	BHUKYA VAMSHI	II
4	20E35A0307	SYED SARFARAZ	II
5	19E31A0305	EDIGI THARUN KUMAR GOUD	II
6	19E31A0306	MD AVEZ	II
7	19E31A0307	MOHAMMED ILIYAS KHAN	II
8	19E31A0308	SANITRA DEVARA	II
9	19E31A0309	SINDE UJWAL	II
10	18E31A0320	MOHAMMED VIGAR UL HAQ SIDDIQUI	II
11	20E35A0308	YELLA SAITEJA	II
12	18E31A0315	MD ABDUL MATEEN AHMED	II
13	18E31A0318	MOHAMMED NISAR UDDIN	II
14	20E35A0301	GUBBALA SHIVA SAHITHI	II
15	20E35A0302	GUGULOTHU DINESH	II
16	20E35A0303	MOTE VYSHNAVI	II
17	20E35A0304	NERALLA SRAVYA	II
18	20E35A0305	PITTALA SAIKIRAN	II
19	20E35A0306	S ROHIT	II
20	20E35A0307	SYED SARFARAZ	II
21	20E35A0308	YELLA SAITEJA	II

Principal
 MAHAVEER
 Engineering College
 Hanthiguda, Venkatapur
 Warangal, Telangana



DEPARTMENT OF MECHANICAL ENGINEERING

Technical Training Exam on CNC

Department of Mechanical Engineering

(A.Y-2020-21)

2x10=20 Marks

Answer All the Questions

PROFILE MILLING:-

1. To prepare a CNC part program to mill the component as per the drawing

Assume thickness = 20mm

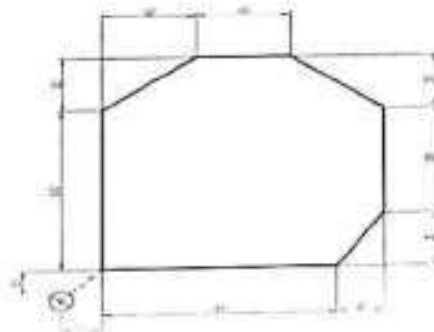

SIMULATION MODEL:-



[Handwritten Signature]
MAHVEER

DATE: _____ TIME: _____



DEPARTMENT OF MECHANICAL ENGINEERING

RADIUS METHOD

2. To prepare a CNC part program to mill the component as per the drawing

Assume thickness = 20 mm

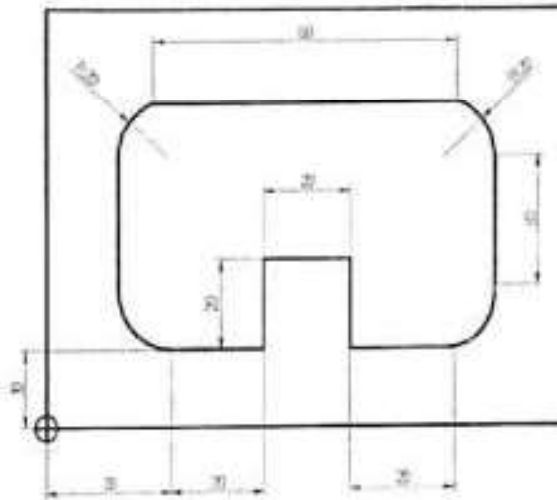

SIMULATION MODEL:-



[Handwritten signature]

DATE

12/11

12/11



DEPARTMENT OF MECHANICAL ENGINEERING

Department of Mechanical Engineering
CNC Technical Training student Marks list 2020-21

S.NO	Roll No	Name of the student	YEAR	MARKS	PASS/FAIL
1	19E31A0301	ABDUL QUADAR BIN ABDUL BARI	II	15	PASS
2	20E35A0306	S ROHIT	II	15	PASS
3	19E31A0303	BHUKYA VAMSHI	II	18	PASS
4	20E35A0307	SYED SARFARAZ	II	16	PASS
5	19E31A0305	EDIGI THARUN KUMAR GOUD	II	15	PASS
6	19E31A0306	MD AVEZ	II	15	PASS
7	19E31A0307	MOHAMMED ILIYAS KHAN	II	16	PASS
8	19E31A0308	SANITRA DEVARA	II	15	PASS
9	19E31A0309	SINDE UJWAL	II	16	PASS
10	18E31A0320	MOHAMMED VIGAR UL HAQ SIDDIQUI	II	12	PASS
11	20E35A0308	YELLA SAITEJA	II	16	PASS
12	18E31A0315	MD ABDUL MATEEN AHMED	II	16	PASS
13	18E31A0318	MOHAMMED NISAR UDDIN	II	12	PASS
14	20E35A0301	GUBBALA SHIVA SAMITHI	II	15	PASS
15	20E35A0302	GUGULOTHU DINESH	II	16	PASS
16	20E35A0303	MOTE VYSHNAVI	II	14	PASS
17	20E35A0304	NERALLA SRAVYA	II	15	PASS
18	20E35A0305	PITTALA SAIKIRAN	II	17	PASS
19	20E35A0306	S ROHIT	II	15	PASS
20	20E35A0307	SYED SARFARAZ	II	16	PASS
21	20E35A0308	YELLA SAITEJA	II	16	PASS

[Handwritten signature and stamp]



DEPARTMENT OF MECHANICAL ENGINEERING

CNC PROGRAMMING COURSE

Summary

Department of Mechanical Engineering

1. Explain applications and advantages of CNC machines and technology
2. Prepare CNC program for CNC Lathe & Milling,
3. Calculate CNC Machining Parameters
4. Prepare process plan, job card, inspection report
5. Handle measuring instrument for inspection
6. Prepare program and execute machining for CNC Lathe, Milling, EDM and WEDM
7. Follow Safety norms during operations

Copy to :

1. Department of Notice Board
2. Principal for Information
3. Committee Members (Academic)

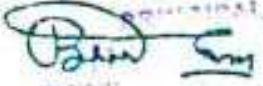
Principal
Bandlaguda Prasad Rao College of Engineering
Hyderabad-500 085, Telangana INDIA

Vyasaiah, Baidyapada Road, Nellore dist,
Hyderabad 502 005, Telangana INDIA
Tel: 040-6466274, 2002973 Fax: 040-2445203
E-mail: principal.mahaveer@mahaveer.com
Website: www.mahaveer.com

MAHAVEER



Approved by AICTE. Accredited by JNTU of Hyd.

DEPARTMENT OF MECHANICAL ENGINEERING

CERTIFICATE OF COURSE COMPLETION

This certificate is presented to Y. Sai Teja of
MIST, who has successfully completed technical training course on
"CNC" held from 03-02-2020 to 13-02-2020 and found the
student performance to be excellent.



ESTD : 2001

B.VENKATESWAR REDDY

HOD

Department of Mechanical Engineering

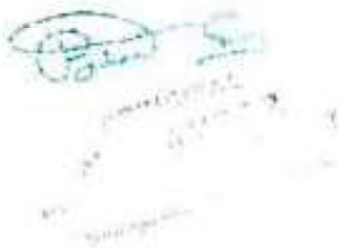

Vysakhari, Bandlaguda Post-Kancharu,
Hyderabad-500 005, Telangana INDIA
Tel: 040-6498979, 20020773, Fax: 040-24468003
E-mail: Principal.mahaveer@ignit.ac.in
Website: www.ignit.ac.in

MAHAVEER

Approved by AICTE, Affiliated to JNTU-Hydr.



DEPARTMENT OF MECHANICAL ENGINEERING

List of students enrolled in CNC Programming (2020-2021)

S.No	Roll No	Name of the student	Date	3/2/20	4/15/20	5/12/20	6/10/20	7/12/20	8/10/20	9/12/20	10/10/20	11/10/20	12/10/20
1	19E31A0301	ABDUL QUADAR BIN ABDUL BARI		P	P	P	P	P	P	P	P	P	P
2	20E35A0306	S ROHIT		P	P	P	P	P	P	P	P	P	P
3	19E31A0303	BHUKYA VAMSIII		P	P	P	P	P	P	P	P	P	P
4	20E35A0307	SYED SARFARAZ		P	P	P	P	P	P	P	P	P	P
5	19E31A0305	EDIGI THARUN KUMAR GOUD		P	P	P	P	P	P	P	P	P	P
6	19E31A0306	MID AVEZ		P	P	P	P	P	P	P	P	P	P
7	19E31A0307	MOHAMMED ILFAS KHAN		P	P	P	P	P	P	P	P	P	P
8	19E31A0308	SANITRA DEVARA		P	P	P	P	P	P	P	P	P	P
9	19E31A0309	SINDE UJWAL		P	P	P	P	P	P	P	P	P	P
10	18E31A0320	MOHAMMED VIGAR UL HAQ SIDDIQUI		P	P	P	P	P	P	P	P	P	P

(Signature)

Vysapuri, Bangalore Post, Karnataka,
 PIN-560001, India
 Tel: 040-9696979, 20020773, Fax: 040-24455003
 E-mail: info@mahaveer.ac.in
 Website: www.mahaveer.ac.in



DEPARTMENT OF MECHANICAL ENGINEERING

List of students enrolled in CNC Programming (2020-2021)

S.No	Roll No	Name of the student	Date														
			31/12/20	31/1/20	31/2/20	31/3/20	31/4/20	31/5/20	31/6/20	31/7/20	31/8/20	31/9/20	31/10/20	31/11/20			
11	20E35A0308	VELLA SATEEJA	P	P	P	P	P	P	P	P	P	P	P	P	P	P	P
12	18E31A0315	MD ABDUL MATEEN AHMED	P	P	P	P	P	P	P	P	P	P	P	P	P	P	P
13	18E31A0318	MOHAMMED NISAR UDDIN	P	P	P	P	P	P	P	P	P	P	P	P	P	P	P
14	20E35A0301	GUBBALA SHIVA SURESH	P	P	P	P	P	P	P	P	P	P	P	P	P	P	P
15	20E35A0302	GUGULOTHU DINI SHI	P	P	P	P	P	P	P	P	P	P	P	P	P	P	P
16	20E35A0307	MOTE VYSIINAVI	P	P	P	P	P	P	P	P	P	P	P	P	P	P	P
17	20E35A0304	NERALLA SIRAVVA	P	P	P	P	P	P	P	P	P	P	P	P	P	P	P
18	20E35A0305	PITTALA SAIKIRAN	P	P	P	P	P	P	P	P	P	P	P	P	P	P	P
19	20E35A0306	S ROHIT	P	P	P	P	P	P	P	P	P	P	P	P	P	P	P
20	20E35A0307	SYED SARFARAZ	P	P	P	P	P	P	P	P	P	P	P	P	P	P	P

DEPARTMENTAL
 OFFICE
 MECHANICAL ENGINEERING
 MAHAVEER INSTITUTE OF SCIENCE & TECHNOLOGY
 BANGALORE

Vyasapuri, Bandlaguda Post Kothavaram,
Hyderabad-500 005, Telangana INDIA.
Tel: 040-64596979, 20020773, Fax: 040-24456003
E-mail: prins@mahaveer.com
Website: www.mahaveer.ac.in

MAHAVER



Approved by AICTE, Affiliated to JNTUH, HYD

DEPARTMENT OF MECHANICAL ENGINEERING

List of students enrolled in CNC Programming (2020-2021)

S.No	Roll No	Name of the student	3/2/2020	4/2/2020	5/2/2020	6/2/2020	7/2/2020	8/2/2020	9/2/2020	10/2/2020	11/2/2020	12/2/2020	13/2/2020
21	20E35A0308	VELLA SAMTEJA	P	P	P	P	P	P	P	P	P	P	P

(Signature)

Principal

MAHAVER

Hyderabad - 500 005, India

Phone: 040-64596979, 20020773

Website: www.mahaveer.ac.in

MAHAVEER

INSTITUTE OF SCIENCE & TECHNOLOGY

Approved by AICTE, Affiliated to JNTUH, Hyd.



Vysapuri, Bandlaguda Post: Keshavgiri,
Hyderabad-500 005, TELANGANA INDIA
Tel: 040-64596979, 8978380692, Fax: 040-24455003
E-mail: e3hod.it@gmail.com, Website: www.mist.ac.in

DEPARTMENT OF ELECTRONICS & COMMUNICATION ENGG

Dept. MIST/ECE dept./1/2020

16-09-2020

To
The Principal
Mahaveer Institute Science & Technology
Hyderabad.

Sub: Request for approval to include ADD-ON subject in regular curriculum of B.Tech, ECE

Resource Person: Dr. V. N Mani, Scientist F
C-MET, Govt. of India
Hyderabad - 500051

In order to increase employability and entrepreneurship for students pursuing B.TECH, department of ECE is planning to organise **ROLE OF ADVANCED ELECTRONIC MATERIALS & DEVICES IN SPACE & DEFENCE APPLICATIONS** as add-on course in regular curriculum for AY 2020-21 for B.TECH 4th year semester-I, apart from regular syllabus as per the JNTUH.

Thanking You

HOD, ECE Dept.

PRINCIPAL
MAHAVEER
INSTITUTE OF SCIENCE & TECHNOLOGY
Bandlaguda, Hyd-500 005.

DEPARTMENT OF ELECTRONICS & COMMUNICATION ENGINEERING

Vysapuri, Bandlaguda Post, Keshavnagar,
Hyderabad-500 005, AP INDIA
Tel: 040-20020772, 20020773, Fax: 040-24455003
E-mail: e3hod.ec@gmail.com,
Website: www.mist.ac.in

MAHAVEER

INSTITUTE OF SCIENCE & TECHNOLOGY
Approved by AICTE, Affiliated to JNTUH, Hyd



Date: 24/09/2020

To
Dr V.N. Mani, Scientist -F
Center for Materials for Electronics & Technology (CMET), Govt of India
Hyderabad-500051

Mobile no. 7382489862

Dear Sir,

As you may be aware, we, MIST, are part of the reputed **MAHAVEER** group of educational institutions and have been in the service of imparting quality education to the society since 2001 i.e. last 19 years.

As part of our overall efforts to improve the outlook of students, we regularly invite scientists, engineers, technocrats, academicians and entrepreneurs of repute to visit our institute and share the latest technical developments and valuable learning's from their professional life with our students. As a part of this 'Invited Technical Lecture' series, many individuals of repute have already delivered lectures at our institute for the benefit of our students and faculty.

As you is a well-known expert with deep domain knowledge in the area of **DESIGN OF ELECTRONICS DEVICES**, it would be a great pleasure to us in inviting you for delivering your expert guest lectures to our students for the subject **"ROLE OF ADVANCED ELECTRONIC MATERIALS AND DEVICES IN SPACE AND DEFENCE APPLICATIONS"** approximately two hours duration in a day in every week during 1st Semester.

We are thankful for accepting our request.

The following is the schedule of expert lectures on the subject:-
Every Saturday, 3rd & 4th periods, except 2nd Saturday of month.

Thanking you,

Your invitation Accepted
[Signature]
25/09/2020

Yours sincerely

HOD, ECE Department,
MIST

Dr. V. N. MANI
Scientist - F

Center for Materials for Electronics Technology (CMET)
Ministry of Science & Information Technology (MSIT)
Govt. of India
IDA Phase - II, Cheruvu, HCL, P.O.,
Hyderabad-500 051, Telangana State, India

PRINCIPAL
MAHAVEER

PRINCIPAL
MAHAVEER
INSTITUTE OF SCIENCE & TECHNOLOGY
Bandlaguda, Hyd-500 005.

Vysapuri, Bandlaguda Post: Keshavnigri,
Hyderabad-500 005, TELANGANA INDIA
Tel: 040-64596979, 8978380692, Fax: 040-24455003
E-mail: e3hod.it@gmail.com, Website: www.mist.ac.in.

MAHAVEER

INSTITUTE OF SCIENCE & TECHNOLOGY

Approved by AICTE, Affiliated to JNTUH, Hyd.



DEPARTMENT OF ELECTRONICS & COMMUNICATION ENGG

ADVANCED EDC-SYLLABUS

BJT small signal model – Analysis of CE, CB, CC amplifiers- Gain and frequency response – MOSFET small signal model- Analysis of CS and Source follower – Gain and frequency response- High frequency analysis.

BIMOS cascade amplifier, Differential amplifier – Common mode and Difference mode analysis – FET input stages – Single tuned amplifiers – Gain and frequency response – Neutralization methods, power amplifiers – Types (Qualitative analysis).

Advantages of negative feedback – voltage / current, series, Shunt feedback – positive feedback – Condition for oscillations, phase shift – Wien bridge, Hartley, Colpits and Crystal oscillators.

Duration : 20 to 25 hrs /semester

K. S. S. S.

MAHAVEER
INSTITUTE OF SCIENCE & TECHNOLOGY
BANDLAGUDA POST-500 005

Vysapuri, Bandlaguda Post: Keshavgi,
Hyderabad-500 005, TELANGANA INDIA
Tel: 040-64596979, 8978380692 Fax: 040-24455003
E-mail: e3hod.it@gmail.com, Website: www.mist.ac.in,

MAHAVEER

INSTITUTE OF SCIENCE & TECHNOLOGY

Approved by AICTE, Affiliated to JNTUH, Hyd.



DEPARTMENT OF ELECTRONICS & COMMUNICATION ENGC

Date: 26-09-2020

CIRCULAR

Technical Trainings on **ROLE OF ADVANCED ELECTRONIC MATERIALS & DEVICES IN SPACE & DEFENCE APPLICATIONS** is starting from **28-09-2020** onwards. All the students IV year B. Tech should attend.

Design and development of curriculum for add-on courses :

Faculty Names: 1. Dr. Inspal Kumar
2. Mr. K. Venkateshwarlu
3. Mr. Deva Raju

HOD, ECE

Cc: Principal for information
: Coordinator to inform the students
: Notice board & department File.



PRINCIPAL,
MAHAVEER
INSTITUTE OF SCIENCE & TECHNOLOGY
Bandlaguda, Hyd-500 005

Vysapuri, Bandlaguda Post:Keshavgiri,

MAHAVEER

INSTITUTE OF SCIENCE & TECHNOLOGY

Approved by AICTE. Affiliated to JNTUH,Hyd.



Hyderabad-500 005, TELANGANA INDIA

Tel: 040-64596979,8978380992,Fax: 040-24465003

E-mail: s3hod_it@gmail.com,

Website: www.mist.ac.in,

DEPARTMENT OF ELECTRONICS AND COMMUNICATION ENGINEERING

LIST OF REGISTERED STUDENTS (AY 2020-21)

S.NO.	H.T. NO.	NAME OF STUDENT
1	ITE31A0401	A SRUKANTH
2	ITE31A0403	AKULA BAMYA SREE
3	ITE31A0404	ANIBULA SEAVAN KUMAR
4	ITE31A0405	APURVA DESHPANDE
5	ITE31A0406	ARAVIND KISHI
6	ITE31A0407	BANDA MOHINDRA YADAV
7	ITE31A0409	BHANI PRATAP MISHRA
8	ITE31A0410	BONALA WANESHA
9	ITE31A0412	CHALLA SAI KRISHNA
10	ITE31A0413	CHEEMENI KAMESH
11	ITE31A0414	CHERI KURI PAVITHRA
12	ITE31A0415	CHIPPY TEJASWI
13	ITE31A0416	CHIBLA ANJELA
14	ITE31A0417	DASARLA PALLY RAVALI
15	ITE31A0418	DAYYALA BALRAM
16	ITE31A0419	DESADONNA SUMEDHA
17	ITE31A0420	DONDATI VEENA
18	ITE31A0421	EESHWARU SIBIRDIA
19	ITE31A0422	ERRAM AJEETHA MUBRAJ
20	ITE31A0423	G KAPIL KUMAR
21	ITE31A0424	G KASHI REDDY
22	ITE31A0425	G RAJESH
23	ITE31A0426	GADDALA SANJAY
24	ITE31A0427	GADDAM JYOSHNA
25	ITE31A0428	GADI SATISH KUMAR
26	ITE31A0429	GAMPALA RANJIT
27	ITE31A0430	GENI RAJKUMAR
28	ITE31A0433	JELLA SRAVYA
29	ITE31A0434	KALYANAM SEVAM SUNDAR RAJ
30	ITE31A0435	KANCHANI VEERAT SWAROOP

K. K. K.

MAHAVEER
INSTITUTE OF SCIENCE & TECHNOLOGY
Bandlaguda, Hyd-500 005

Vysapuri, Bandlaguda Post: Keshavgiri,

Hyderabad-500 005, TELANGANA INDIA

Tel: 040-64596979, 6978380692, Fax: 040-24455003

E-mail: e3hod.it@gmail.com

Website: www.mist.ac.in

MAHAVEER

INSTITUTE OF SCIENCE & TECHNOLOGY

Approved by AICTE, Affiliated to JNTUH, Hyd.



DEPARTMENT OF ELECTRONICS AND COMMUNICATION ENGINEERING

QUESTION PAPER

ROLE OF ADVANCED ELECTRONIC MATERIALS & DEVICES IN SPACE & DEFENCE APPLICATIONS.

Duration: 120 Minutes

5 X6 = 30Marks

Answer the following all questions. Each question carries 6 marks.

- 1 Explain the operation of BJT as an Amplifier in CB & CC Configurations .
- 2 Input and Output Characteristics depletion type N-CH , MOSFET
- 3 Explain the Base to emitter bias Operation & Compared it with all others .
- 4 Explain about the diode characteristics.
- 5 Explain Compensation techniques

K. S. S.

PRINCIPAL
MAHAVEER
INSTITUTE OF SCIENCE & TECHNOLOGY
Bandlaguda, Hyd-500 005.

Vysapuri, Bandlaguda Post:Keshavgi,

Hyderabad-500 005, TELANGANA INDIA
Tel: 040-64596979,8978380692.Fax: 040-24455003
E-mail: e3hod.it@gmail.com,
Website: www.mist.ac.in.

MAHAVEER

INSTITUTE OF SCIENCE & TECHNOLOGY

Approved by AICTE. Affiliated to JNTUH,Hyd.



DEPARTMENT OF ELECTRONICS AND COMMUNICATION ENGINEERING

31	17E31A0436	KARATA MEGHANA
32	17E31A0437	KARNATI JEEVAN REDDY
33	17E31A0438	KATTAGURI SHIVANI
34	17E31A0439	KODATI VAMSHI
35	17E31A0440	KONAPARTHI RAMYASRI
36	17E31A0441	KONDI AKHILA
37	17E31A0442	KOTTE PRASANTHI
38	17E31A0444	MADISHETTI LAKSHI CHANDRA
39	17E31A0445	MAHADEVI RENUKA
40	17E31A0446	MALLUGARI SATHIYUKA
41	17E31A0447	MEPISA SUMITH CHANDRA
42	17E31A0448	MERUGU GAVATHIRI
43	17E31A0449	NAGAM VANDHANA
44	17E31A0450	NAGAPURI RAHUL
45	17E31A0451	NOOKALA SRIKANTH
46	17E31A0452	PAVULURI NAGABHARGAV
47	17E31A0453	PILLITLA MANOJ KUMAR
48	17E31A0454	RAPPELLY KALYANI
49	17E31A0456	SAINAD REDDY NAINI
50	17E31A0457	SANDEEP KUMAR HOWDEKARY
51	17E31A0458	SANUGOMULA MADHU PRIYA
52	17E31A0459	SHAIK HUSSAIN
53	17E31A0461	SHIKARI SRI VIDYA
54	17E31A0465	V RAHUL
55	17E31A0466	VEMULA AVINASHI
56	17E31A0467	VIRRA GNANESHWARI
57	17E31A0469	VUDUTHALA AMBA BHAVANI
58	18E15A0401	BURRAGALLA V PREETHAM
59	18E15A0402	NIRATI RAJASRI
60	18E15A0403	S GOPEKISHAN
61	18E15A0404	SINGAM JYOTHI

K. Srinivas

Principal
MAHAVEER
INSTITUTE OF SCIENCE & TECHNOLOGY
Bandlaguda, Hyd-500 005

Vysapuri, Bandlaguda Post:Keshavgi,

Hyderabad-500 005, TELANGANA INDIA
Tel: 040-64596979,8978380692,Fax: 040-24455003
E-mail: g3hod.it@gmail.com,
Website: www.mist.ac.in,

MAHAVEER

INSTITUTE OF SCIENCE & TECHNOLOGY

Approved by AICTE, Affiliated to JNTUH,Hyd.



DEPARTMENT OF ELECTRONICS AND COMMUNICATION ENGINEERING

ATTENDANCE & RESULT AY 2020-21

S.NO.	H.T. NO.	NAME OF STUDENT	ATTENDACE (20HRS)	MARKS OBTAINED(30)
1	17E31A0401	A SRIKANTH	20	27
2	17E31A0403	AKIITA RAMYA SREE	16	23
3	17E31A0404	ANUMITA BRAVAN KUMAR	18	25
4	17E31A0405	APURVA DESHPANDE	20	22
5	17E31A0406	ARAVIND JOSHI	17	21
6	17E31A0407	BANDIA MOJINIK A YADAV	20	20
7	17E31A0409	BHARGU PRATAP MISHRA	18	19
8	17E31A0410	BONAI A MANEESHA	20	22
9	17E31A0412	CHALLA SAIKRISHNA	20	28
10	17E31A0413	CHENIMENI RAMESH	20	23
11	17E31A0414	CHERUKURI PAVITHRA	17	17
12	17E31A0415	CHITTE TEJASWI	17	22
13	17E31A0416	CHIRLA AKHILA	18	26
14	17E31A0417	DASARLA PALLY RAVALI	20	25
15	17E31A0418	DAYYALA BALRAM	19	25
16	17E31A0419	DEKABOINA SUMEDHA	18	22
17	17E31A0420	DOMMATTI VEENA	20	21
18	17E31A0421	KESHWAROU SHRISHA	18	26
19	17E31A0422	ERRAM ALAKHYA MUDIRAJ	20	19
20	17E31A0423	G RAHUL KUMAR	18	22
21	17E31A0424	G RAHUL REDDY	17	18
22	17E31A0425	G RAKESH	19	23
23	17E31A0426	GADDALA SANJAY	20	17
24	17E31A0427	GADDAM JYOSHINA	17	22
25	17E31A0428	GADI SATISH KUMAR	20	27
26	17E31A0429	GAMPALA RAHUL	18	21
27	17E31A0430	GIRNIRAJKUMAR	20	26
28	17E31A0435	JELLA SRAVYA	17	19
29	17E31A0434	KALYANAM SHYAM SUNDER RAO	18	22
30	17E31A0435	KANCHANI VIRAT SWAROOP	20	19

K. Srinivas

Principal
MAHAVEER
INSTITUTE OF SCIENCE & TECHNOLOGY
Bandlaguda, Hyd-500 005

vysapuri, Bandlaguda Post:Keshavgiri,

MAHAVEER

INSTITUTE OF SCIENCE & TECHNOLOGY

Approved by AICTE, Affiliated to JNTUH, Hyd.



Hyderabad-500 005, TELANGANA INDIA

Tel: 040-64596979,8978380692 Fax: 040-24455003

E-mail: e3hod.it@gmail.com

Website: www.mist.ac.in

DEPARTMENT OF ELECTRONICS AND COMMUNICATION ENGINEERING

31	17E31A0436	KARATA MEGHANA	31	20
32	17E31A0437	KARNATI BEVAN REDDY	28	25
33	17E31A0438	KATTAGURI SHIVANI	19	23
34	17E31A0439	KODATI VAMSHI	22	22
35	17E31A0440	KONAPARTHI RAMYASRI	18	21
36	17E31A0441	KONDI AKHILA	20	25
37	17E31A0442	KOTTE PRASHANTH	17	19
38	17E31A0443	MADSHETTI AKASH CHANDRA	20	22
39	17E31A0445	MAHADEVI KUNUKA	20	23
40	17E31A0446	MALLUGARI SATHVIKA	20	23
41	17E31A0447	MEENA SUMITH CHANDRA	17	17
42	17E31A0448	MERUGU GAYATHI	18	22
43	17E31A0449	NAGAM VANDHANA	19	26
44	17E31A0450	NAGAPURI RAHUL	20	23
45	17E31A0451	NOKKALA SUKANTH	17	25
46	17E31A0452	PAVULURI NAGABHARGAV	20	21
47	17E31A0453	PELUTTA MANOJ KUMAR	18	21
48	17E31A0454	RAPPELLY KALYANI	20	26
49	17E31A0455	SAINAD REDDY NAINI	19	19
50	17E31A0457	SANDEEP KUMAR HOWDELAJAY	17	22
51	17E31A0458	SANGGOMULA MADHU PRIYA	18	24
52	17E31A0459	SHAIK HUSSAIN	20	23
53	17E31A0461	SHIKARI SRI VIDYA	20	21
54	17E31A0465	V RAJUL	20	22
55	17E31A0466	VEMULA AVINASH	20	27
56	17E31A0467	VERA GNANESHWAR	18	21
57	17E31A0469	VEDUTHALA AMBIA BHAVANI	19	26
58	18E35A0401	BURRAGALLA V PREETHAM	20	23
59	18E35A0402	NIKATI RAJASRI	18	22
60	18E35A0403	S GOPI KISHAN	20	20
61	18E35A0404	SINGAM JYOTHI	20	21

K. K. K.
PRINCIPAL
MAHAVEER
INSTITUTE OF SCIENCE & TECHNOLOGY
Bandlaguda, Hyderabad



DEPARTMENT OF ELECTRONICS & COMMUNICATION ENGG

ATTENDANCE OF THE STUDENT: (AY. 2020-21, Sem-I)

S.N	REG. NO	NAME OF STUDENT	Attendance																				ATTENDANCE PERCENTAGE	
			1	2	3	4	5	6	7	8	9	10	11	12	13	14	15	16	17	18	19	20		
1	17E31A0401	A. SIBICANTH	1	2	3	4	5	6	7	8	9	10	11	12	13	14	15	16	17	18	19	20	20	
2	17E31A0403	ARTHA RAMYA SREJA	A	1	2	3	4	A	5	6	7	8	9	A	10	11	12	A	13	14	15	16	16	
3	17E31A0404	ANUMULA SRAVAN KUMAR	A	A	1	2	3	4	5	6	7	8	9	10	11	12	13	14	15	16	17	18	18	
4	17E31A0405	AJURVA DEEPADEVI	1	2	3	4	5	6	7	8	9	10	11	12	13	14	15	16	17	18	19	20	20	
5	17E31A0406	ARAVIND JOSHI	1	2	3	4	A	5	6	7	A	8	9	10	11	12	13	A	14	15	16	17	17	
6	17E31A0407	BANUJA MOUNIKA YADAV	1	2	3	4	5	6	7	8	9	10	11	12	13	14	15	16	17	18	19	20	20	
7	17E31A0408	BIJANU PRATAP SHYBHA	1	2	3	4	A	5	6	7	8	9	10	11	12	13	A	14	15	16	17	18	18	
8	17E31A0410	BHAGALA MANJESHA	1	2	3	4	5	6	7	8	9	10	11	12	13	14	15	16	17	18	19	20	20	
9	17E31A0412	CHITLA SAI KRISHNA	1	2	3	4	5	6	7	8	9	10	11	12	13	14	15	16	17	18	19	20	20	
10	17E31A0413	CHENIMINI RAMESH	1	2	3	4	5	6	7	8	9	10	11	12	13	14	15	16	17	18	19	20	20	
11	17E31A0414	CHERUKURI PASTHIRA	1	2	3	A	4	5	6	7	8	A	9	10	11	12	13	A	14	15	16	17	17	
12	17E31A0415	CHIPPETEJASWI	A	1	2	3	4	5	6	7	8	9	10	A	11	12	13	14	A	15	16	17	17	
13	17E31A0416	CHITLA ARHILA	A	1	2	3	4	A	5	6	7	8	9	10	11	12	13	14	15	16	17	18	18	
14	17E31A0417	DASARLA PALLY RAVALI	1	2	3	4	5	6	7	8	9	10	11	12	13	14	15	16	17	18	19	20	20	
15	17E31A0418	DAMMALA DALRAM	1	2	3	4	5	6	7	8	9	10	11	12	13	A	14	15	16	17	18	19	19	
16	17E31A0419	DEVARAJANA SUMEDHA	1	2	3	4	5	6	7	8	9	10	11	12	13	14	15	16	17	18	A	A	18	
17	17E31A0420	DURIMATI VEENA LESI (WAROJI)	1	2	3	4	5	6	7	8	9	10	11	12	13	14	15	16	17	18	19	20	20	
18	17E31A0421	SHREYA	1	2	3	4	5	6	7	8	9	10	A	11	12	13	14	A	15	16	17	18	18	
19	17E31A0422	IRSAM ALEXIYA MURRALI	1	2	3	4	5	6	7	8	9	10	11	12	13	14	15	16	17	18	19	20	20	
20	17E31A0423	G. RAHUL KUMAR	1	2	3	4	A	5	6	7	8	9	10	11	12	13	14	A	15	16	17	18	18	
21	17E31A0424	G. RAHUL REDDY	A	1	2	3	4	A	5	6	7	8	9	10	A	11	12	13	14	15	16	17	17	
22	17E31A0425	G. RAKESH	1	2	3	4	5	6	7	8	9	10	11	12	13	14	15	16	17	18	19	20	19	
23	17E31A0426	GADIDALA SANJAY	1	2	3	4	5	6	7	8	9	10	11	12	13	14	15	16	17	18	19	20	20	
24	17E31A0427	GADIDAMAYOSHINA GATH SATISH KUMAR	A	1	2	3	4	A	5	6	7	8	9	10	A	11	12	13	A	14	15	16	17	17
25	17E31A0428	GADIDAMAYOSHINA GATH SATISH KUMAR	1	2	3	4	5	6	7	8	9	10	11	12	13	14	15	16	17	18	19	20	20	
26	17E31A0429	GAMPALA RAHUL	1	2	3	4	5	6	7	8	9	10	A	11	12	13	14	A	15	16	17	18	18	
27	17E31A0430	GIBINI RAJ KUMAR	1	2	3	4	5	6	7	8	9	10	11	12	13	14	15	16	17	18	19	20	20	
28	17E31A0431	JEDLA SRAYYA KALYANAM SHYAM SENDER KAO	1	2	3	4	A	5	6	7	8	9	10	11	12	13	A	14	15	16	17	18	17	
29	17E31A0434	KACHANI VIRAT SWAROOP	1	2	3	4	A	5	6	7	8	9	10	11	12	13	14	15	16	17	18	19	18	
30	17E31A0435	KACHANI VIRAT SWAROOP	1	2	3	4	5	6	7	8	9	10	11	12	13	14	15	16	17	18	19	20	20	

K. Srinivas

PRINCIPAL
 MAHAVEER
 INSTITUTE OF SCIENCE & TECHNOLOGY
 Bandlapada, Hyd-500 005.



DEPARTMENT OF ELECTRONICS & COMMUNICATION ENGG

31	17E31A0416	KAPATA MEGHANA	1 2 3 4 5 6 7 8 9 10 11 12 13 14 15 16 17 18 19 20
32	17E31A0437	KARNATI JEEVAN REDDY	1 2 3 4 5 6 7 8 9 10 11 12 13 14 15 16 17 18 19 20
33	17E31A0438	KATTAGURI SHIVANI	1 2 3 4 5 6 7 8 9 10 11 12 13 14 15 16 17 18 19
34	17E31A0439	KODATI VAMSHI	1 2 3 4 5 6 7 8 9 10 11 12 13 14 15 16 17 18 19 20
35	17E31A0440	KCHAPARTHI RANYASRI	1 2 3 4 5 6 7 8 9 10 11 12 13 14 15 16 17 18
36	17E31A0441	KONDI AKHILA	1 2 3 4 5 6 7 8 9 10 11 12 13 14 15 16 17 18 19 20
37	17E31A0447	KOTU PRASHANTH	1 2 3 4 5 6 7 8 9 10 11 12 13 14 15 16 17
38	17E31A0444	MADISHETTI AKASH CHANDRA	1 2 3 4 5 6 7 8 9 10 11 12 13 14 15 16 17 18 19 20
39	17E31A0445	MAHADEVI RENUKA	1 2 3 4 5 6 7 8 9 10 11 12 13 14 15 16 17 18 19 20
40	17E31A0446	MA. LUGARI SATHVIKA	1 2 3 4 5 6 7 8 9 10 11 12 13 14 15 16 17 18 19 20
41	17E31A0447	MEESA SUMITH CHANDRA	1 2 3 4 5 6 7 8 9 10 11 12 13 14 15 16 17
42	17E31A0448	MEYAGU DAYATHRI	1 2 3 4 5 6 7 8 9 10 11 12 13 14 15 16 17 18
43	17E31A0449	NAGAM VANDHANA	1 2 3 4 5 6 7 8 9 10 11 12 13 14 15 16 17 18 19
44	17E31A0450	NAGAPURI RAHUL	1 2 3 4 5 6 7 8 9 10 11 12 13 14 15 16 17 18 19 20
45	17E31A0451	NEONALA SRI-KAITEE	1 2 3 4 5 6 7 8 9 10 11 12 13 14 15 16 17 18 19
46	17E31A0452	PAVELURE NAGABHARGAV	1 2 3 4 5 6 7 8 9 10 11 12 13 14 15 16 17 18 19 20
47	17E31A0453	PULLULA MANOJ KUMAR	1 2 3 4 5 6 7 8 9 10 11 12 13 14 15 16 17 18
48	17E31A0454	RAPELLI KALYANI	1 2 3 4 5 6 7 8 9 10 11 12 13 14 15 16 17 18 19 20
49	17E31A0455	SANAD REDDY NAINI	1 2 3 4 5 6 7 8 9 10 11 12 13 14 15 16 17 18 19
50	17E31A0457	SANTHEEP KUMAR HOWDEKARY	1 2 3 4 5 6 7 8 9 10 11 12 13 14 15 16 17
51	17E31A0458	SANTOSHOMILA MANGHU PRIYA	1 2 3 4 5 6 7 8 9 10 11 12 13 14 15 16 17 18
52	17E31A0459	SHAIK HUSSAIN	1 2 3 4 5 6 7 8 9 10 11 12 13 14 15 16 17 18 19 20
53	17E31A0461	SHUKARI SRI VIDYA	1 2 3 4 5 6 7 8 9 10 11 12 13 14 15 16 17 18 19 20
54	17E31A0465	V. SAIJITH	1 2 3 4 5 6 7 8 9 10 11 12 13 14 15 16 17 18 19 20
55	17E31A0466	VENULA AVINASH VERRA	1 2 3 4 5 6 7 8 9 10 11 12 13 14 15 16 17 18 19 20
56	17E31A0467	GNANESHWAR VIJITHALA AMBA BHAVANI	1 2 3 4 5 6 7 8 9 10 11 12 13 14 15 16 17 18
57	17E31A0469	BIJAPAGALLA V PREETHAM	1 2 3 4 5 6 7 8 9 10 11 12 13 14 15 16 17 18 19 20
58	18E35A0401	NIRA TRAJASRI	1 2 3 4 5 6 7 8 9 10 11 12 13 14 15 16 17 18
59	18E35A0402	S. GOPI KISHAN	1 2 3 4 5 6 7 8 9 10 11 12 13 14 15 16 17 18 19 20
60	18E35A0403	SINGAM IYOTHI	1 2 3 4 5 6 7 8 9 10 11 12 13 14 15 16 17 18 19 20

[Signature]
Co-ordinator

[Signature]

[Signature]
HOD, ECE

PRINCIPAL
MAHAVEER
INSTITUTE OF SCIENCE & TECHNOLOGY
Hyderabad-500 005

Vysapuri, Bandlaguda Post, Keshavgiri,

Hyderabad-500 005, TELANGANA INDIA
Tel: 040-64596979, 8978380692 Fax: 040-24455003
E-mail: e3hod.it@gmail.com
Website: www.mist.ac.in

MAHAVEER

INSTITUTE OF SCIENCE & TECHNOLOGY
Approved by AICTE, Affiliated to JNTUH, Hyd.



DEPARTMENT OF ELECTRONICS AND COMMUNICATION ENGINEERING

Date: 01-12-2020

CIRCULAR

Technical Trainings on **PYTHON PROGRAMMING** is starting from **23-12-2020** onwards. All the students IV year II Semester, B.Tech should attend.

Design and development of curriculum for add-on courses :

Faculty Names: 1. Dr. Jaspal Kumar
2. Mr. Ch. Sandeep Kumar
3. Mrs. S Soujanya

HOD, ECE

Cc: Principal for information
Co-ordinator to inform the students
Notice board & department File.



PRINCIPAL
MAHAVEER
INSTITUTE OF SCIENCE & TECHNOLOGY
Bandlaguda, Hyd-500 005.

Vysapuri, Bandlaguda Post, Keshavgi, Hyderabad-500 005, TELANGANA INDIA

Tel: 040-64596979, 8978380692 Fax: 040-24455003

E-mail: ejhod_it@gmail.com

Website: www.mist.ac.in

MAHAVEER

INSTITUTE OF SCIENCE & TECHNOLOGY

Approved by AICTE, Affiliated to JNTUH, Hyd.



DEPARTMENT OF ELECTRONICS AND COMMUNICATION ENGINEERING

SYLLABUS FOR PYTHON PROGRAMMING

SN O	TOPIC COVERED	DURATIO N
1	Introduction	3
2	Functions	3
3	Modules	3
4	Sequences, iteration and string formatting	3
5	Dictionaries, sets and files	3
6	Exceptions, testing, comprehensions	3
7	Advanced argument passing	3
8	Lambda – functions as objects	3
9	Object oriented programming	3
10	Properties, special methods	3
11	Iterators, iterables and generators	3
12	Decorators, context managers	3
13	Regular expressions	3

HOD-ECE



PRINCIPAL
MAHAVEER
INSTITUTE OF SCIENCE & TECHNOLOGY
Bandlaguda, Hyd-500 005.

Vysapuri, Bandlaguda Post, Keshavgiri,

Hyderabad-500 005, TELANGANA INDIA

Tel: 040-64596979, 8978380692 Fax: 040-24455003

E-mail: e3hod_it@gmail.com,

Website: www.mist.ac.in,

MAHAVEER

INSTITUTE OF SCIENCE & TECHNOLOGY

Approved by AICTE, Affiliated to JNTUH, Hyd



DEPARTMENT OF ELECTRONICS AND COMMUNICATION ENGINEERING

LIST OF REGISTERED STUDENTS FOR PYTHON PROGRAMMING

S.NO.	H.F. NO.	NAME OF STUDENT
1	16E31A0401	ADABOINA AKSHAYA
2	16E31A0402	AENLUGULA SWATHI
3	16E31A0403	ANAGOONI SHIVANI GOUD
4	16E31A0405	ASHALA GANESH
5	16E31A0406	AVVARI BHARGAVI
6	16E31A0407	B NAVYA SRI
7	16E31A0408	BADAM SAI SHANKER
8	16E31A0410	BYREDDY SRIDEVI
9	16E31A0413	DESHAM PREETHIKA
10	16E31A0415	DHARAVATH THARUN
11	16E31A0416	ENJAMURI PAVAN SAI PREETAM
12	16E31A0419	G HARISH
13	16E31A0420	HASBI SHRUTHI
14	16E31A0421	JAGIDI VAMSHIKRISHNA
15	16E31A0422	KAKUSTAM PAVANI
16	16E31A0423	KALWA HARIKA
17	16E31A0426	KONAPARTHY ANJALITHARY
18	16E31A0427	KOTTALA VIKRAM
19	16E31A0428	KOVADA SWARNALATHA
20	16E31A0429	KULKARNI MANGI
21	16E31A0430	LAGISHETTY ADITHYA
22	16E31A0433	MOHAMMAD AMEER KHAN
23	16E31A0435	PAKEER GANESH
24	16E31A0436	PANYALA NAYYASREE
25	16E31A0437	PARIDULA SHIVA TEJA
26	16E31A0438	PETA SAI TEJA
27	16E31A0439	POKURI SHEKAR
28	16E31A0440	PRAVALIKA GADDAM
29	16E31A0442	RAPELLI HARIKA
30	16E31A0443	SHAIK RASHEEDA BEGUM

K. Srinivas

PRINCIPAL
MAHAVEER
INSTITUTE OF SCIENCE & TECHNOLOGY
Bandlaguda, Hyd-500 005.

Vysapuri, Bandlaguda Post: Keshavgi,

Hyderabad-500 005, TELANGANA INDIA
Tel: 040-64596970,8978380692, Fax: 040-24455003
E-mail: e3hod_it@gmail.com,
Website: www.mist.ac.in,

MAHAVEER

INSTITUTE OF SCIENCE & TECHNOLOGY

Approved by AICTE, Affiliated to JNTUH,Hyd.



DEPARTMENT OF ELECTRONICS AND COMMUNICATION ENGINEERING

31	16E31A0456	ABHILASH REDDY KODIGANTI
32	16E31A0457	AERUKALA SAT CHITRA
33	16E31A0459	ANANTHOJU SHIVANI
34	16E31A0460	ANKAM SRIVARSHA
35	16E31A0461	ANNABOINA SITALINI
36	16E31A0462	ANNAM SRAVAN
37	16E31A0463	ANUGONDA KIRAN KUMAR REDDY
38	16E31A0464	ANUMOLU NARENDRA SAI
39	16E31A0465	B PRADEEP
40	16E31A0466	BATTA SREE AMRUTH VAMSHI
41	16E31A0467	BUJALA SHRAYANI
42	16E31A0468	BODDUPALLI VAMSHIKRISHNA
43	16E31A0469	CH SUSHMITHA
43	16E31A0470	CHALLA VABUN REDDY
44	16E31A0471	CHEKKALA GANESH
45	16E31A0476	ELAGANDHALA VAMSHI PRANAV
46	16E31A0477	ELLENDULA VARSHITH
47	16E31A0479	GANGIREDDY MAHENDER

Kanthy

PRINCIPAL
MAHAVEER
INSTITUTE OF SCIENCE & TECHNOLOGY
Bandlaguda, Hyd-500 005.

Vysapuri, Bandlaguda Post, Keshavgi, Hyderabad-500 005, TELANGANA INDIA

Tel: 040-64596979, 8978380692, Fax: 040-24455003

E-mail: ajhod.ite@gmail.com

Website: www.mist.ac.in

MAHAVEER

INSTITUTE OF SCIENCE & TECHNOLOGY

Approved by AICTE, Affiliated to JNTUH, Hyd.



DEPARTMENT OF ELECTRONICS AND COMMUNICATION ENGINEERING

PYTHON PROGRAMMING QUESTION PAPER

Duration: 120 Minutes

4 X 5 = 20 Marks

Answer the following all questions. Each question carries 5 marks.

1. Write a python program to check whether the given string is palindrome or not?
2. Write a python program to interchange first and last element in list?
3. Write a python program to print all prime number in a given range?
4. Write a python program to sort first list using second list?

HOD-ECE

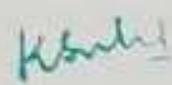
PRINCIPAL
MAHAVEER
INSTITUTE OF SCIENCE & TECHNOLOGY
Bandlaguda, Hyd-500 005

Vysapuri, Bandlaguda Post, Keshavgirl,

Hyderabad-500 005, TELANGANA INDIA
Tel: 040-64596979, 8978380692, Fax: 040-24455003
E-mail: e3hod.it@gmail.com
Website: www.mist.ac.in

MAHAVEER

INSTITUTE OF SCIENCE & TECHNOLOGY

Approved by AICTE, Affiliated to JNTUH, Hyd.



DEPARTMENT OF ELECTRONICS AND COMMUNICATION ENGINEERING

RESULT SHEET FOR PYTHON PROGRAMMING REGISTERED STUDENTS

S.NO.	H.T. NO.	NAME OF STUDENT	ATTENDACE 20)HRS	MARKS OBTAINED(30)
1	16E31A0401	ADABOINA AKSHAYA	17	26
2	16E31A0402	AENUGULA SWATHI	18	28
3	16E31A0403	ANAGOUNI SHIV ANI GOUD	18	22
4	16E31A0405	ASHALA GANESH	20	23
5	16E31A0406	AVVARI BHARGAVI	17	ABSENT
6	16E31A0407	B NAVYA SRI	20	26
7	16E31A0408	BADAM SAI SHANKER	18	10
8	16E31A0410	BYREDDY SRIDEVI	20	22
9	16E31A0413	DENHAM PREETHIKA	19	26
10	16E31A0415	DHAPAVATHI THARUN	20	23
11	16E31A0416	ENJAMURI PAVAN SAI PREETAM	18	26
12	16E31A0418	G HARISH	20	10
13	16E31A0420	RASBI SHRUTHI	19	22
14	16E31A0421	JAGIDI VAMSHUKRISHNA	17	23
15	16E31A0422	KAKUSTAMPAVANI	18	22
16	16E31A0423	KALWA HARIKA	20	25
17	16E31A0426	KONAPARTHY ANJA CHARY	20	28
18	16E31A0427	KOTTALA VIKRAM	20	23
19	16E31A0428	KOYADA SWARNALATHA	20	29
20	16E31A0429	KULKARNI MANOJ	18	23
21	16E31A0430	LAGISHETTY ADITHYA	18	20
22	16E31A0433	MOHAMMAD AMEER KHAN	20	27
23	16E31A0435	PAKTER GANESH	20	24
24	16E31A0436	PANYALA NAVYASREE	20	21
25	16E31A0437	PARIDULA SHIVA TEJA	20	25
26	16E31A0438	PETA SAI TEJA	18	25
27	16E31A0439	POKURI SHEKAR	19	20
28	16E31A0440	PRAVALIKA GADDAM	20	21
29	16E31A0442	RAPELLI HARIKA	18	23
30	16E31A0443	SHAIK RASHEEDA BEGUM	20	22

Rasheed
BRINGING
FEL
BANDLAGUDA, HYD-500 005.

Vysapuri, Bandlaguda Post:Keshavgiri,

Hyderabad-500 005, TELANGANA INDIA
Tel: 040-64596979,8978360692,Fax: 040-24455003
E-mail: eshod.h@gmail.com
Website: www.mist.ac.in

MAHAVEER

INSTITUTE OF SCIENCE & TECHNOLOGY

Approved by AICTE, Affiliated to JNTUH,Hyd.



DEPARTMENT OF ELECTRONICS AND COMMUNICATION ENGINEERING

31	16E31A0456	ABHILASH REDDY KODIGANTI	20	23
32	16E31A0457	AERUKALA SAI CHITRA	20	22
33	16E31A0459	ANANTHOJU SHIVANI	20	28
34	16E31A0460	ANKAM SRIVARSHA	20	20
35	16E31A0461	ANNABOINA SHALINI	18	23
36	16E31A0462	ANNAM SRAVAN	20	29
37	16E31A0463	ANUGONDA KIRAN KUMAR REDDY	18	23
38	16E31A0464	ANJIMOLU NARENDRA SAI	20	20
39	16E31A0465	B PRADEEP	19	27
40	16E31A0466	BATTA SREE AMRUTH VAMSHI	17	24
41	16E31A0467	BUJALA SHRAVANI	18	21
42	16E31A0468	BODDUPALLI VAMSHIKRISHNA	20	25
43	16E31A0469	CH SUSHMITHA	20	25
43	16E31A0470	CHALLA VARUN REDDY	19	20
44	16E31A0471	CHEKKALA GANESH	19	21
45	16E31A0476	ELAGANDHALA VAMSHI PRANAY	16	22
46	16E31A0477	ELLENDULA VARSHITH	19	25
47	16E31A0479	GANGIREDDY MAHENDER	17	28

No. of students Registered:47

No. of students Passed:47

No. of students failed:NIL

K. Srinivas

PRINCIPAL
MAHAVEER
INSTITUTE OF SCIENCE & TECHNOLOGY
Bandlaguda, Hyd-500 005

Vysapuri, Bandlaguda Post:Keshavgiri,

Hyderabad-500 005, TELANGANA INDIA
Tel: 040-64596979,8978380692, Fax: 040-24455003
E-mail: a3hod.it@gmail.com,
Website: www.mist.ac.in,

MAHAVEER

INSTITUTE OF SCIENCE & TECHNOLOGY

Approved by AICTE, Affiliated to JNTUH,Hyd.



DEPARTMENT OF ELECTRONICS AND COMMUNICATION ENGINEERING

SUMMARY REPORT OF PYTHON PROGRAMMING

- Python programming language is considered as simple language as it extracts most of the concepts of C and Java in terms of syntax.
- Python programming is used to learn how to design, program the python applications and explains how to use lists, tuples and dictionaries in python programs
- It explains how to identify python object types to use indexing and slicing to access data and also to define the structure and components of a python program
- It contains the concepts of loops and decision control statements and a parameter passing techniques
- It explains the concepts of packages and to read write into the python file, has beautiful concepts of inheriting a class and ability to handle the exceptions

COORDINATOR

Copy to:

1. Department Notice Board
2. Principal for Information
3. Committee Members (Academic)

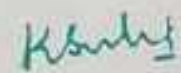
PRINCIPAL
MAHAVEER
INSTITUTE OF SCIENCE & TECHNOLOGY
Bandlaguda, Hyd-500 005

Attendance sheet for: PYTHON PROGRAMMING registered students:

Sno	Roll Ticket No	Name of the Candidate	1	2	3	4	5	6	7	8	9	10	11	12	13	14	15	16	17	18	19	20	ATTENDANCE (%) (20hrs)
1	16E31A0401	ADARSHINA AKSHAYA	1	2	3	4	5	6	7	8	9	10	11	12	13	14	15	16	17	18	19	20	17
2	16E31A0402	AENINGSULA SWATHI	1	2	3	4	5	6	7	8	9	10	11	12	13	14	15	16	17	18	19	20	18
3	16E31A0403	ANAGOLANISHIVANI OODU	1	2	3	4	5	6	7	8	9	10	11	12	13	14	15	16	17	18	19	20	18
4	16E31A0405	ASHALA GANESH	1	2	3	4	5	6	7	8	9	10	11	12	13	14	15	16	17	18	19	20	20
5	16E31A0406	AVVARI BHARGAVI	1	2	3	4	5	6	7	8	9	10	11	12	13	14	15	16	17	18	19	20	17
6	16E31A0407	B NAVYA SRI	1	2	3	4	5	6	7	8	9	10	11	12	13	14	15	16	17	18	19	20	20
7	16E31A0408	BADAM SAI SHANKAR	1	2	3	4	5	6	7	8	9	10	11	12	13	14	15	16	17	18	19	20	18
8	16E31A0410	BYREDDY SRIDEVI	1	2	3	4	5	6	7	8	9	10	11	12	13	14	15	16	17	18	19	20	20
9	16E31A0413	BESHAM PREETHIKA	1	2	3	4	5	6	7	8	9	10	11	12	13	14	15	16	17	18	19	20	19
10	16E31A0415	DEHARAVATH THARUN	1	2	3	4	5	6	7	8	9	10	11	12	13	14	15	16	17	18	19	20	20
11	16E31A0416	ENDAMURE PAVAN SAI PREETAM	1	2	3	4	5	6	7	8	9	10	11	12	13	14	15	16	17	18	19	20	18
12	16E31A0418	G HARISH	1	2	3	4	5	6	7	8	9	10	11	12	13	14	15	16	17	18	19	20	20
13	16E31A0420	HANSHI ABHUTHI	A	1	2	3	4	5	6	7	8	9	10	11	12	13	14	15	16	17	18	19	19
14	16E31A0421	JAGDEEVAMISHRAKRISHNA	1	2	3	4	5	6	7	8	9	10	11	12	13	14	15	16	17	18	19	20	17
15	16E31A0422	KARVISTAMI PAVANI	1	2	3	4	5	6	7	8	9	10	11	12	13	14	15	16	17	18	19	20	18
16	16E31A0423	KALWA HARIKA	1	2	3	4	5	6	7	8	9	10	11	12	13	14	15	16	17	18	19	20	20
17	16E31A0425	KONAPARTHY ANJALI CHARY	1	2	3	4	5	6	7	8	9	10	11	12	13	14	15	16	17	18	19	20	20
18	16E31A0437	KOTTALA VIKRAM	1	2	3	4	5	6	7	8	9	10	11	12	13	14	15	16	17	18	19	20	20
19	16E31A0428	KOVADA SWARNALATHA	1	2	3	4	5	6	7	8	9	10	11	12	13	14	15	16	17	18	19	20	20
20	16E31A0429	KULKARNI MANOJ	1	2	3	4	5	6	7	8	9	10	11	12	13	14	15	16	17	18	19	20	18
21	16E31A0430	LAKSHMETTY ADITHYAN	1	2	3	4	5	6	7	8	9	10	11	12	13	14	15	16	17	18	19	20	18
22	16E31A0433	MORAMMAD AMEER KHAN	1	2	3	4	5	6	7	8	9	10	11	12	13	14	15	16	17	18	19	20	20
23	16E31A0435	PAKEER GANESH	1	2	3	4	5	6	7	8	9	10	11	12	13	14	15	16	17	18	19	20	20
24	16E31A0436	PANVALA NAVYASHREE	1	2	3	4	5	6	7	8	9	10	11	12	13	14	15	16	17	18	19	20	20
25	16E31A0437	PARDOLA SHIVA TEJA	1	2	3	4	5	6	7	8	9	10	11	12	13	14	15	16	17	18	19	20	20
26	16E31A0438	PEYA SAI TEJA	1	2	3	4	5	6	7	8	9	10	11	12	13	14	15	16	17	18	19	20	18
27	16E31A0439	POKURI SHEKAR	1	2	3	4	5	6	7	8	9	10	11	12	13	14	15	16	17	18	19	20	19
28	16E31A0440	PRAVALIKA GADIDAM	1	2	3	4	5	6	7	8	9	10	11	12	13	14	15	16	17	18	19	20	20
29	16E31A0442	RAPILLI HARIKA	1	2	3	4	5	6	7	8	9	10	11	12	13	14	15	16	17	18	19	20	18
30	16E31A0443	SHAK RASHEEDA BEGUM	1	2	3	4	5	6	7	8	9	10	11	12	13	14	15	16	17	18	19	20	20
31	16E31A0450	ASHILASH REDDY KODIGANTI	1	2	3	4	5	6	7	8	9	10	11	12	13	14	15	16	17	18	19	20	20

INSTITUTE OF SCIENCE & TECHNOLOGY
Bansalagaruda, Hyd-500 545

32	16E31A0467	AERUKALA SAI CHITRA	1	2	3	4	5	6	7	8	9	10	11	12	13	14	15	16	17	18	19	20
33	16E31A0469	ANANTHODJ SHIVANI	1	2	3	4	5	6	7	8	9	10	11	12	13	14	15	16	17	18	19	20
34	16E31A0460	ANKAM SRIVARSHA	1	2	3	4	5	6	7	8	9	10	11	12	13	14	15	16	17	18	19	20
35	16E31A0461	ANNARDINA SHREINI	1	2	3	4	5	6	7	8	A	9	10	11	12	13	A	14	15	16	17	18
36	16E31A0462	ANNAM SRIVANI	1	2	3	4	5	6	7	8	9	10	11	12	13	14	15	16	17	18	19	20
37	16E31A0463	REDDY	1	2	3	4	5	6	7	8	A	9	10	11	A	12	13	14	15	16	17	18
38	16E31A0464	ANUMOLU NARENDRA SAI	1	2	3	4	5	6	7	8	9	10	11	12	13	14	15	16	17	18	19	20
39	16E31A0465	B PRADEEP	1	2	3	4	5	6	7	8	9	10	11	A	12	13	14	15	16	17	18	19
40	16E31A0466	BATTA SREE AMRUTH VAMSHI	1	2	3	A	4	5	6	7	8	9	10	A	11	12	13	14	15	A	16	17
41	16E31A0467	BIJULA SHRAVANI	1	2	3	4	5	6	7	8	9	10	11	12	13	14	15	A	16	17	18	19
42	16E31A0468	BODUPALLI VAMSHIKRISHNA	1	2	3	4	5	6	7	8	9	10	11	12	13	14	15	16	17	18	19	20
43	16E31A0460	CH SUSHMITHA	1	2	3	4	5	6	7	8	9	10	11	12	13	14	15	16	17	18	19	20
44	16E31A0470	CHALLA VARUN REDDY	1	2	3	4	5	6	7	8	9	10	A	11	12	13	14	15	16	17	18	19
45	16E31A0471	CHEKKALA GANESH	1	2	3	4	5	6	7	A	8	9	10	11	12	13	14	15	16	17	18	19
46	16E31A0476	PRANAY	1	2	3	A	4	5	6	7	A	8	9	10	11	A	12	13	14	A	15	16
47	16E31A0477	ELLENDELA VARSHITH	1	2	3	4	5	6	7	8	9	A	10	11	12	13	14	15	16	17	18	19
48	16E31A0479	GANGIREDDY MAHENDER	1	2	3	4	5	6	A	7	8	9	A	10	11	12	13	14	15	A	16	17

Co-ordinator

HOD, ECE Dept



PRINCIPAL
PAAVEER
INSTITUTE OF TECHNOLOGY
HYDARABAD

Vysapuri, Bandlaguda Post:Keshavgiri,

Hyderabad-500 005, TELANGANA INDIA
Tel: 040-64596979,8978380692,Fax: 040-24455003
E-mail: e3hod.cse@gmail.com,
Website: www.mist.ac.in,

MAHAVEER

INSTITUTE OF SCIENCE & TECHNOLOGY

Approved by AICTE, Affiliated to JNTUH,Hyd.



DEPARTMENT OF COMPUTER SCIENCE AND ENGINEERING

Date:01-06-2020

CIRCULAR

Technical Trainings for III & IV B. Tech students are starting from 07-06-2020 onwards. All HODs and placements coordinators have to manage the trainings and ensure 95% attendance all through the sessions.

All mentors need to send the compiled feedback report to HOD at e3hod.cse@gmail.com daily. Mentors are advised to take care of PNR (Students not participating in training).

Agenda: 3D Graphics

HOD-CSE

PRINCIPAL
MAHAVEER
INSTITUTE OF SCIENCE & TECHNOLOGY
Bandlaguda, Hyd-500 005.

Vysapuri, Bandlaguda Post:Keshavgiri,

Hyderabad-500 005, TELANGANA INDIA
Tel: 040-64596979,8978380692, Fax: 040-24455003
E-mail: e3hod.cse@gmail.com,
Website: www.mist.ac.in,

MAHAVEER

INSTITUTE OF SCIENCE & TECHNOLOGY

Approved by AICTE, Affiliated to JNTUH,Hyd.



DEPARTMENT OF COMPUTER SCIENCE AND ENGINEERING

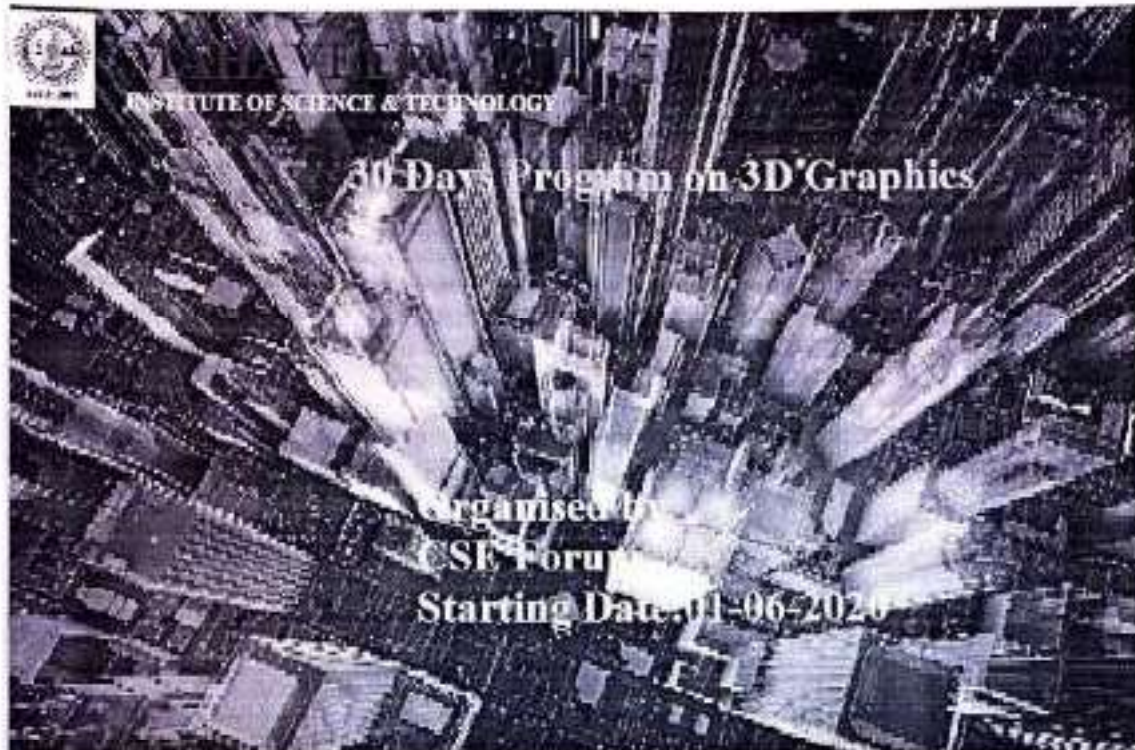

PRINCIPAL
MAHAVEER
INSTITUTE OF SCIENCE & TECHNOLOGY
BANDLAGUDA, HYD-500 005.

Vysapuri, Bandlaguda Post:Keshavgi,ri,

MAHAVEER

INSTITUTE OF SCIENCE & TECHNOLOGY

Approved by AICTE, Affiliated to JNTUH,Hyd.



Hyderabad-500 005, TELANGANA INDIA

Tel: 040-64596979,8978380692,Fax: 040-24455003

E-mail: e3hod.cse@gmail.com,

Website: www.mist.ac.in,

DEPARTMENT OF COMPUTER SCIENCE AND ENGINEERING

SYLLABUS FOR 3D GRAPHICS

SNO	TOPIC COVERED	DURATION
1	Introduction	3
2	Describe and apply the mathematical basics of 3D graphics	3
3	Describe the Fundamentals of digital representation and processing of color information	3
4	Describe and apply basic concepts of radiometry and light transport	3
5	Describe hardware architecture of GPUs	3
6	Describe the software architecture of 3D graphics programs	3
7	Describe and apply data structures for 3D graphics applications	3
8	Describe and apply special graphic programming techniques	3
9	Use 3D graphics programming interface	3

HOD-CSE 



PRINCIPAL
MAHAVEER

Vysapuri, Bandlaguda Post:Keshavgi,ri,

Hyderabad-500 005, TELANGANA INDIA
Tel: 040-64596979,8978380692, Fax: 040-24465003
E-mail: e3hod.cse@gmail.com,
Website: www.mist.ac.in,

MAHAVEER

INSTITUTE OF SCIENCE & TECHNOLOGY
Approved by AICTE, Affiliated to JNTUH,Hyd.



DEPARTMENT OF COMPUTER SCIENCE AND ENGINEERING

LIST OF REGISTERED STUDENTS FOR 3D GRAPHICS

SNO	HALL TICKET NO	NAME OF THE STUDENT
1	17E31A0501	A SHIRISHA
2	17E31A0502	BANDARI VARUN KUMAR
3	17E31A0504	BOGEE SUPRIYA
4	17E31A0507	CHEEMALA MAHESH
5	17E31A0508	CHELLOJU ANUSHA
6	17E31A0509	CHENCHU HARISH
7	17E31A0510	D GANESH
8	17E31A0512	G.HARIKA
9	17E31A0514	GANECHARY SHREYA
10	17E31A0515	GEETHIKA C
11	17E31A0516	GURRAM MANI RUPAK
12	17E31A0517	HUSNA HIBA
13	17E31A0519	JANUMPALLY GAYATHRI REDDY
14	17E31A0520	KANKATI ARAVIND
15	17E31A0521	KASULA VISHAKA
16	17E31A0522	KONGARI CHANDANA
17	17E31A0523	KOPPULA ANUSHRI
18	17E31A0525	KURA AKHILESH

PRINCIPAL
MAHAVEER
INSTITUTE OF SCIENCE & TECHNOLOGY
Bandlaguda, Hyd-500 005.

Vysapuri, Bandlaguda Post:Keshavgiri,

Hyderabad-500 005, TELANGANA INDIA

Tel: 040-64596979,8978380692,Fax: 040-24455003

E-mail: e3hod.cse@gmail.com,

Website: www.mist.ac.in,

MAHAVEER

INSTITUTE OF SCIENCE & TECHNOLOGY

Approved by AICTE, Affiliated to JNTUH,Hyd.



DEPARTMENT OF COMPUTER SCIENCE AND ENGINEERING

19	17E31A0526	L ANIKETH SINGH
20	17E31A0528	LONE HARISH
21	17E31A0551	ADDAGATLA HARINATH
22	17E31A0552	AKULA VARUN GOUD
23	17E31A0554	AMBATI POOJA
24	17E31A0555	ANUGU LAXMIKANTH REDDY
25	17E31A0556	BAIMUTHAKA TRIVENI
26	17E31A0558	BORRA SOMESHWAR REDDY
27	17E31A0559	CHIPPA SRI LAKSHMI
28	17E31A0560	CHOLLETI PRASANNA
29	17E31A0562	DORAGOLLA MADHU
30	17E31A0563	GOSANGARI VEENA
31	17E31A0564	GUBBA HARSHAVARDHAN GUPTA
32	17E31A0565	HARI SHANKER SHARMA
33	17E31A0567	KAREDDY VAMSHI
34	17E31A0568	KAVALI SRIKANTH
35	17E31A0570	KURMETI REVANTH
36	18E31A0501	A TARUN
37	18E31A0502	ABDUL AZIZ MASOOD
38	18E31A0503	ABDUL RAZZAQ
39	18E31A0505	AMBATI RADHIKA

PRINCIPAL
MAHAVEER
INSTITUTE OF SCIENCE & TECHNOLOGY
Bandlaguda, Hyd-500 005.

Vysapuri, Bandlaguda Post:Keshavgirl,

Hyderabad-500 005, TELANGANA INDIA

Tel: 040-64596979,8978380692,Fax: 040-24455003

E-mail: g3hod.cse@gmail.com

Website: www.mist.ac.in

MAHAVEER

INSTITUTE OF SCIENCE & TECHNOLOGY

Approved by AICTE, Affiliated to JNTUH,Hyd



DEPARTMENT OF COMPUTER SCIENCE AND ENGINEERING

40	18E31A0506	BIJJALA SUMA
41	18E31A0507	BUSIGAMPALA PRAVALLIKA
42	18E31A0508	C K NIKHIL SWAROOP
43	18E31A0509	CHALLA VISWATEJO KIRAN
44	18E31A0510	CHENNU VIVEK YADAV
45	18E31A0513	GANDLA PRATHYUSH KUMAR
46	18E31A0515	GUNDATI SANJANA
47	18E31A0516	GUNDRATHI SAI PAVAN GOUD
48	18E31A0517	JAGATHA SRIKRISHNA
49	18E31A0556	BALAI SRUJAN
50	18E31A0557	BASA HARSHA VARDHAN
51	18E31A0558	BOLLIKONDA AKHILA
52	18E31A0559	BUTTA BHARATH
53	18E31A0560	CHANDRACHARYA NITIN RAJU

PRINCIPAL
MAHAVEER
INSTITUTE OF SCIENCE & TECHNOLOGY
Bandlaguda, Hyd-500 005.

Vysapuri, Bandlaguda Post:Keshavgiri,

Hyderabad-500 005, TELANGANA INDIA
Tel: 040-64596979,8978380692 Fax: 040-24455003
E-mail: e3hod.cse@gmail.com,
Website: www.mist.ac.in,

MAHAVEER

INSTITUTE OF SCIENCE & TECHNOLOGY

Approved by AICTE, Affiliated to JNTUH,Hyd.



DEPARTMENT OF COMPUTER SCIENCE AND ENGINEERING

3D GRAPHICS QUESTION PAPER

Duration: 120 Minutes

8 X 5 = 40 Marks

Answer the following all questions. Each question carries 5 marks.

1. What is computer graphics?
2. Write the properties of video display devices?
3. Write the essential application of computer-graphics?
4. Write the difference between vector and raster graphics?
5. Define Aspect Ratio?
6. Differentiate between Raster and Vector Graphics?
7. Write the properties of video display devices?
8. What is scaling?

HOD-CSE

PRINCIPAL
MAHAVEER
INSTITUTE OF SCIENCE & TECHNOLOGY
Bandlaguda, Hyd-500 005.

Vysapuri, Bandlaguda Post:Keshavgirl,

Hyderabad-500 005, TELANGANA INDIA
Tel: 040-64596979,8978380692 Fax: 040-24455003
E-mail: e3hod.cse@gmail.com.
Website: www.mist.ac.in,

MAHAVEER

INSTITUTE OF SCIENCE & TECHNOLOGY

Approved by AICTE, Affiliated to JNTUH,Hyd



DEPARTMENT OF COMPUTER SCIENCE AND ENGINEERING

RESULT SHEET FOR 3D GRAPHICS REGISTERED STUDENTS

SNO	HALL TICKET NO	NAME OF THE STUDENT	MARKS (20)	RESULT
1	17E31A0501	A SHIRISHA	20	PASS
2	17E31A0502	BANDARI VARUN KUMAR	19	PASS
3	17E31A0504	BOGEE SUPRIYA	20	PASS
4	17E31A0507	CHEEMALA MAHESH	18	PASS
5	17E31A0508	CHELLOJU ANUSHA	20	PASS
6	17E31A0509	CHENCHU HARISH	20	PASS
7	17E31A0510	D GANESH	16	PASS
8	17E31A0512	G.HARIKA	20	PASS
9	17E31A0514	GANECHARY SHREYA	20	PASS
10	17E31A0515	GEETHIKA C	17	PASS
11	17E31A0516	GURRAM MANI RUPAK	20	PASS
12	17E31A0517	HUSNA HIBA	20	PASS
13	17E31A0519	JANUMPALLY GAYATHRI REDDY	16	PASS
14	17E31A0520	KANKATI ARAVIND	20	PASS
15	17E31A0521	KASULA VISHAKA	20	PASS
16	17E31A0522	KONGARI CHANDANA	18	PASS
17	17E31A0523	KOPPLA ANUSHRI	20	PASS
18	17E31A0525	KURA AKHILESH	19	PASS
19	17E31A0526	L ANIKETH SINGH	20	PASS

PRINCIPAL
MAHAVEER
INSTITUTE OF SCIENCE & TECHNOLOGY
Bandlaguda, Hyd-500 005

Vysapuri, Bandlaguda Post:Keshavgi,ri,

MAHAVEER



Hyderabad-500 005, TELANGANA INDIA
Tel: 040-64596979,8978380692, Fax: 040-24455003

E-mail: e3hod.cse@gmail.com,

Website: www.mist.ac.in,

Approved by AICTE, Affiliated to JNTUH,Hyd.

DEPARTMENT OF COMPUTER SCIENCE AND ENGINEERING

20	17E31A0528	LONE HARISH	18	PASS
21	17E31A0551	ADDAGATLA HARINATH	20	PASS
22	17E31A0552	AKULA VARUN GOUD	20	PASS
23	17E31A0554	AMBATI POOJA	16	PASS
24	17E31A0555	ANUGU LAXMIKANTH REDDY	20	PASS
25	17E31A0556	BAIMUTHAKA TRIVENI	20	PASS
26	17E31A0558	BORRA SOMESHWAR REDDY	20	PASS
27	17E31A0559	CHIPPA SRI LAKSHMI	18	PASS
28	17E31A0560	CHOLLETI PRASANNA	20	PASS
29	17E31A0562	DORAGOLLA MADHU	19	PASS
30	17E31A0563	GOSANGARI VEENA	20	PASS
31	17E31A0564	GUBBA HARSHAVARDHAN GUPTA	18	PASS
32	17E31A0565	HARI SHANKER SHARMA	20	PASS
33	17E31A0567	KAREDDY VAMSHI	20	PASS
34	17E31A0568	KAVALI SRIKANTH	16	PASS
35	17E31A0570	KURMETI REVANTH	20	PASS
36	18E31A0501	A TARUN	20	PASS
37	18E31A0502	ABDUL AZIZ MASOOD	17	PASS
38	18E31A0503	ADBDUL RAZZAQ	20	PASS
39	18E31A0505	AMBATI RADHIKA	20	PASS
40	18E31A0506	BIJALA SUMA	16	PASS

PRINCIPAL

MAHAVEER

INSTITUTE OF SCIENCE & TECHNOLOGY
BANDLAGUDA, HYD-500 005.

Vysapuri, Bandlaguda Post:Keshavglri,

Hyderabad-500 005, TELANGANA INDIA
Tel: 040-64596979,8978380692.Fax: 040-24455003
E-mail: e3hod.cse@gmail.com.
Website: www.mist.ac.in,

MAHAVEER

INSTITUTE OF SCIENCE & TECHNOLOGY
Approved by AICTE, Affiliated to JNTUH,Hyd.



DEPARTMENT OF COMPUTER SCIENCE AND ENGINEERING

41	18E31A0507	BUSIGAMPALA PRAVALLIKA	20	PASS
42	18E31A0508	C K NIKHIL SWAROOP	20	PASS
43	18E31A0509	CHALLA VISWATEJO KIRAN	18	PASS
44	18E31A0510	CHENNU VIVEK YADAV	20	PASS
45	18E31A0513	GANDLA PRATHYUSH KUMAR	19	PASS
46	18E31A0515	GUNDATI SANJANA	20	PASS
47	18E31A0516	GUNDRATHI SAI PAVAN GOUD	18	PASS
48	18E31A0517	JAGATHA SRIKRISHNA	20	PASS
49	18E31A0556	BALAI SRUJAN	20	PASS
50	18E31A0557	BASA HARSHA VARDHAN	16	PASS
51	18E31A0558	BOLLIKONDA AKHILA	20	PASS
52	18E31A0559	BUTTA BHARATH	20	PASS
53	18E31A0560	CHANDRACHARYA NITIN RAJU	16	PASS

No. of students Registered:53

No. of students Passed:53

No. of students failed:NIL

PRINCIPAL
MAHAVEER
INSTITUTE OF SCIENCE & TECHNOLOGY
Bandlaguda, Hyd-500 005.

Vysapuri, Bandlaguda Post:Keshavgiri,

Hyderabad-500 005, TELANGANA INDIA
Tel: 040-64596979,8978380692.Fax: 040-24455003
E-mail: g3hod.cse@gmail.com,
Website: www.mist.ac.in,

MAHAVEER

INSTITUTE OF SCIENCE & TECHNOLOGY

Approved by AICTE, Affiliated to JNTUH,Hyd.



DEPARTMENT OF COMPUTER SCIENCE AND ENGINEERING

SUMMARY REPORT OF 3D Graphics

- 3D computer graphics, or three-dimensional computer graphics (in contrast to 2D computer graphics), are **graphics that use a three-dimensional representation of geometric data** (often Cartesian) that is stored in the computer for the purposes of performing calculations and rendering 2D images.

COORDINATOR

Copy to:

1. Department Notice Board
2. Principal for Information
3. Committee Members (Academic)

PRINCIPAL
MAHAVEER
INSTITUTE OF SCIENCE & TECHNOLOGY
Bandlaguda, Hyderabad-500 005

Vysapuri, Bandlaguda Post:Keshavgiri,

Hyderabad-500 005, TELANGANA INDIA

Tel: 040-64596979,8978380692,Fax: 040-24455003

E-mail: e3hod.it@gmail.com,

Website: www.mist.ac.in,

MAHAVEER

INSTITUTE OF SCIENCE & TECHNOLOGY

Approved by AICTE, Affiliated to JNTUH,Hyd.



DEPARTMENT OF INFORMATION TECHNOLOGY

Date:25-11-2020

To,

The principal,
MIST,
Hyderabad.

Sub: Proposal for Add-on Course--Reg.

Dear Sir,

We are going to conduct two weeks workshop on PYTHON PROGRAMMING. We require your approval to go head for further proceeding and hope to get an opportunity to serve you the best.

With thanks and Regards

PRINCIPAL
MAHAVEER
INSTITUTE OF SCIENCE & TECHNOLOGY
Bandlaguda, Hyd-500 005.

HOD
Dr. A. Nanda Gopal Reddy
HOD, Dept. of Information Technology
Mahaveer Institute of Science & Tech
Vysapuri, Bandlaguda Post Keshavgiri
Hyderabad-500005.

Vysapuri, Bandlaguda Post:Kothavglri,

Hyderabad-500 005, TELANGANA INDIA
Tel: 040-84696979,0970380692.Fax: 040-24465003
E-mail: e3hod.it@gmail.com,
Website: www.mist.ac.in,

MAHAVEER

INSTITUTE OF SCIENCE & TECHNOLOGY
Approved by AICTE, Affiliated to JNTUH,Hyd.



DEPARTMENT OF INFORMATION TECHNOLOGY

Date:01-12-2020

CIRCULAR

Technical Trainings for III & IV B. Tech students are starting from 29-12-2020 onwards. All HODs and placements coordinators have to manage the trainings and ensure 95% attendance all through the sessions.

All mentors need to send the compiled feedback report to HOD at e3hod@gmail.com daily. Mentors are advised to take care of PNR (Students not participating in training).

Agenda: PYTHON PROGRAMMING

Design and Development of Curriculum for Add on Course:

Name of the Faculty: 1.Dr.A.NANDA GOPAL REDDY
2.K.B.V.K NAGASREE
3.V.NARESH KUMAR REDDY

PRINCIPAL
MAHAVEER
INSTITUTE OF SCIENCE & TECHNOLOGY
Vysapuri, Bandlaguda Post, Hyderabad-500 005.

HOD
Dr.A.Nanda Gopal Reddy
HOD, Dept.of Information Technology
Mahaveer Institute of Science & Technology
Vysapuri, Bandlaguda Post:Kothavglri
Hyderabad-500005.

Vysapuri, Bandlaguda Post:Keshavgiri,

Hyderabad-500 005, TELANGANA INDIA
Tel: 040-64596979,8978380692,Fax: 040-24455003
E-mail: a3hod.it@gmail.com,
Website: www.mist.ac.in,

MAHAVEER
INSTITUTE OF SCIENCE & TECHNOLOGY
Approved by AICTE. Affiliated to JNTUH,Hyd.



DEPARTMENT OF INFORMATION TECHNOLOGY

SYLLABUS FOR PYTHON PROGRAMMING

SNO	TOPIC COVERED	DURATION
1	Introduction	3
2	Functions	3
3	Modules	3
4	Sequences, iteration and string formatting	3
5	Dictionaries, sets and files	3
6	Exceptions, testing, comprehensions	3
7	Advanced argument passing	3
8	Lambda – functions as objects	3
9	Object oriented programming	3
10	Properties, special methods	3
11	Iterators, iterables and generators	3
12	Decorators, context managers	3
13	Regular expressions	3

PRINCIPAL
MAHAVEER
INSTITUTE OF SCIENCE & TECHNOLOGY
Bandlaguda, Hyd-500 005.

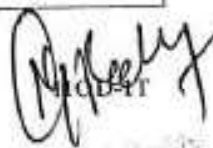
Dr. A. Srinivas Reddy
Head of Department
Department of Information Technology
Vysapuri, Post: Keshavgiri,
Bandlaguda, Hyd-500 005.

Vysapuri, Bandlaguda Post:Keshavgi,

Hyderabad-500 005, TELANGANA INDIA

Tel: 040-64596979,8978380692. Fax: 040-24455003

E-mail: e3hod.it@gmail.com,

Website: www.mist.ac.in,

MAHAVEER

INSTITUTE OF SCIENCE & TECHNOLOGY

Approved by AICTE, Affiliated to JNTUH,Hyd.



DEPARTMENT OF INFORMATION TECHNOLOGY

LIST OF REGISTERED STUDENTS FOR PHYTHON PROGRAMMING

SNO	HALL TICKET NO	NAME OF THE STUDENT
1	17E31A1201	AKULA SAI JAINAVI
2	17E31A1203	BAINGAR HARI PRASAD
3	17E31A1205	BHARADWAJ AJITH
4	17E31A1206	BOLLA KIRAN KUMAR
5	17E31A1207	C PRASHANSHA
6	17E31A1208	CEELA MAHESH
7	17E31A1209	GANDHAM SHYAMALA
8	17E31A1210	KAAVATI VINEETHA
9	17E31A1211	KAKANI JIJMA BINDU
10	17E31A1212	KANDUKURI VINITHA
11	17E31A1213	LAKSHIKA PAREEK
12	17E31A1214	LOKA SAMHITHA
13	17E31A1215	MADISHETTY BHAVYA SRI
14	17E31A1217	MARAM AKSHITHA
15	17E31A1218	MEKA SRIKRISHNA
16	17E31A1219	MIRYALA MOUNIKA
17	17E31A1220	MOHAMMED ABDUL RAZZAK
18	17E31A1221	MOHAMMED JAWAD
19	17E31A1222	MOHD HUSSAIN UDDIN
20	17E31A1223	MOHD MOIN UDDIN SIDDIQUI
21	17E31A1227	PATHA SAIKIRAN
22	17E31A1229	RAVUTLA PRANEETH
23	17E31A1230	SAMA NAVYA
24	17E31A1231	TUMMA NISHANTH KUMAR
25	17E31A1232	VIDHYADAR SHARMA P
26	17E31A1233	YASMEEN BEGUM
27	16E31A1215	MOHD SALMAN
28	18E31A1201	AFRAH MOHAMMADI
29	18E31A1202	AINDLA ABHISHEK
30	18E31A1203	AMUDALA SHRAVAN GOUD
31	18E31A1205	BEERAVOLU SHIRSHIKA
32	18E31A1206	BODEPUDI RISHINATH
33	18E31A1207	CHILAKAPATI SANJAY BHARADWAJ
34	18E31A1208	CHIMATA AKHILA
35	18E31A1209	DANDU SRINU
36	18E31A1210	DARA ANUJ
37	18E31A1211	FAREHIA MUZAFFAR
38	18E31A1212	GYADA MAMATHA
39	18E31A1213	J VAMSIH
40	18E31A1214	KIRAN KUMARI
41	18E31A1216	MAILARAM MAMATHA
42	18E31A1218	MOHAMMED ZAHED HUSSAIN
43	18E31A1219	MOURYA POOJA
44	18E31A1220	P BISHWAJITH

PRINCIPAL
MAHAVEER INSTITUTE OF SCIENCE & TECHNOLOGY
Bandlaguda, Hyderabad

Vysapuri, Bandlaguda Post:Keshavnagar,

Hyderabad-500 005, TELANGANA INDIA
Tel: 040-64596979,8978380692,Fax: 040-24455003
E-mail: c3hed.it@gmail.com,
Website: www.mist.ac.in,

MAHAVEER

INSTITUTE OF SCIENCE & TECHNOLOGY
Approved by AICTE, Affiliated to JNTUH,Hyd.



DEPARTMENT OF INFORMATION TECHNOLOGY

45	18E31A1221	POLKAM PUSHPALATHA
46	18E31A1222	VANAMALA SAI SANTHOSH CHARY
47	18E31A1223	RAGHAVENDAR REDDY B
48	18E31A1226	THIPPAREDDY MAHESHWAR REDDY
49	18E31A1227	THRUNAGARI JAYANTHI
50	19E35A1201	GUGULOTH MAHESH
51	19E35A1202	PENDYALA SHARATH CHANDRA
52	19E35A1204	SHAIK MOHAMMED NEYMATHI FURQAN MEHDI
53	17E31A1224	MOTHE NITHIN REDDY

(Handwritten signature)

(Handwritten signature)

PROVINCIAL
INSTITUTE OF SCIENCE & TECHNOLOGY
Bandlaguda, Hyd-500 005

Vysapuri, Bandlaguda Post:Keshavgiri,

Hyderabad-500 005, TELANGANA INDIA
Tel: 040-64596979,8978380692,Fax: 040-24455003
E-mail: a3hod.it@gmail.com,
Website: www.mist.ac.in,

MAHAVEER

INSTITUTE OF SCIENCE & TECHNOLOGY

Approved by AICTE, Affiliated to JNTUH,Hyd.



DEPARTMENT OF INFORMATION TECHNOLOGY

PYTHON PROGRAMMING QUESTION PAPER

Duration: 120 Minutes

4 X 5 = 20 Marks

Answer the following all questions. Each question carries 5 marks.

1. Write a python program to check whether the given string is palindrome or not?
2. Write a python program to interchange first and last element in list?
3. Write a python program to print all prime number in a given range?
4. Write a python program to sort first list using second list?

HOD-IT

Dr.A.Nanda Gopal Reddy
HOD, Dept.of Information Technology
Mahaveer Institute of Science & Technology
Vyasapuri, Bandlaguda Post:Keshavgiri
Hyderabad-500 005.

PRINCIPAL
MAHAVEER
INSTITUTE OF SCIENCE & TECHNOLOGY
Bandlaguda, Hyd-500 005.

Vysapuri, Bandlaguda Post:Keshavgiri,

Hyderabad-500 005, TELANGANA INDIA
Tel: 040-64596979,8978380692,Fax: 040-24455003
E-mail: e3hod.it@gmail.com,
Website: www.mist.ac.in,

MAHAVEER
INSTITUTE OF SCIENCE & TECHNOLOGY
Approved by AICTE, Affiliated to JNTUH,Hyd.



DEPARTMENT OF INFORMATION TECHNOLOGY

RESULT SHEET FOR PYTHON PROGRAMMING REGISTERED STUDENTS

SNO	HALL TICKET NO	NAME OF THE STUDENT	MARKS (20)	RESULT
1	17E31A1201	AKULA SAI JAHNAVI	20	PASS
2	17E31A1203	BAINGAR HARI PRASAD	19	PASS
3	17E31A1205	BHARADWAJ AJITH	20	PASS
4	17E31A1206	BOLLA KIRAN KUMAR	18	PASS
5	17E31A1207	C PRASHANSHA	20	PASS
6	17E31A1208	CEELA MAHESH	20	PASS
7	17E31A1209	GANDHAM SHYAMALA	16	PASS
8	17E31A1210	KAAVATI VINEETHA	20	PASS
9	17E31A1211	KAKANI HIMA BINDU	20	PASS
10	17E31A1212	KANDUKURI VINITHA	17	PASS
11	17E31A1213	LAKSHIKA PAREEK	20	PASS
12	17E31A1214	LOKA SAMIITHA	20	PASS
13	17E31A1215	MADISHETTY BHAVYA SRI	16	PASS
14	17E31A1217	MARAM AKSHITHA	20	PASS
15	17E31A1218	MEKA SRIKRISHNA	20	PASS
16	17E31A1219	MIRYALA MOUNIKA	18	PASS
17	17E31A1220	MOHAMMED ABDUL RAZZAK	20	PASS
18	17E31A1221	MOHAMMED JAWAD	19	PASS
19	17E31A1222	MOHD HUSSAIN UDDIN	20	PASS
20	17E31A1223	MOHD MOIN UDDIN SIDDIQUI	18	PASS
21	17E31A1227	PATHA SAJKIRAN	20	PASS
22	17E31A1229	RAVUTLA PRANEETH	20	PASS
23	17E31A1230	SAMA NAVYA	16	PASS
24	17E31A1231	TUMMA NISHANTH KUMAR	20	PASS
25	17E31A1232	VIDHYADAR SHARMA P	20	PASS
26	17E31A1233	YASMEEN BEGUM	20	PASS
27	16E31A1215	MOHD SALMAN	18	PASS
28	18E31A1201	AFRAH MOHAMMADI	20	PASS
29	18E31A1202	AINDLA AHUSHEK	19	PASS
30	18E31A1203	AMUDALA SHRAVAN GOUD	20	PASS
31	18E31A1205	BEERAVOLU SHIRSHIKA	18	PASS
32	18E31A1206	BODEPUDI RISHINATH	20	PASS
33	18E31A1207	CHILAKAPATI SANJAY BHARADWAJ	20	PASS
34	18E31A1208	CHIMATA AKHILA	16	PASS
35	18E31A1209	DANDU SRINU	20	PASS
36	18E31A1210	DARA ANUJ	20	PASS
37	18E31A1211	FAREEHA MUZAFFAR	17	PASS
38	18E31A1212	GYADA MAMATHA	20	PASS
39	18E31A1213	JVAMSHI	20	PASS
40	18E31A1214	KIRAN KUMARI	16	PASS
41	18E31A1216	MAILARAM MAMATHA	20	PASS
42	18E31A1218	MOHAMMED ZAHED HUSSAIN	20	PASS
43	18E31A1219	MOURYA POOJA	20	PASS
44	18E31A1220	P BISHWAJITH	18	PASS

PPINT-18-18
MAHAVEER INSTITUTE OF SCIENCE & TECHNOLOGY
Bandlaguda, Hyderabad

Vysavi, Bandlaguda Post: Keshavnagar,

Hyderabad-500 005, TELANGANA INDIA
Tel: 040-64599979, 6978380692 Fax: 040-24455003
E-mail: ashed.r@gmail.com
Website: www.mist.ac.in

MAHAVEER

INSTITUTE OF SCIENCE & TECHNOLOGY

Approved by AICTE, Affiliated to JNTU Hyd.



DEPARTMENT OF INFORMATION TECHNOLOGY

45	18E31A1221	PULKAMPUSHPALATHA	19	PASS
46	18E31A1222	VANAMALA SAI SANTHOSH CHARY	20	PASS
47	18E31A1223	RAGHAVENDAR REDDY B	18	PASS
48	18E31A1226	THIPPAREDDY MAHESHWAR REDDY	20	PASS
49	18E31A1227	THIRUNAGARI JAYANTHI	20	PASS
50	19E35A1201	GUGULOTH MAHESH	16	PASS
51	19E35A1202	PENDYALA SHARATH CHANDRA	20	PASS
52	19E35A1204	SILAK MOHAMMED NEYMATHI FURQAN MEHDI	20	PASS
53	17E31A1224	MOTHE NITHIN REDDY	16	PASS

No. of students Registered:53
No. of students Passed:53
No. of students failed:NIL

Dr. A. Manoj Kumar
HOD, Department of Information Technology
Mahaveer Institute of Science & Technology
Bandlaguda, Hyderabad-500 005

Dr. A. Manoj Kumar
Principal
MAHAVEER
INSTITUTE OF SCIENCE & TECHNOLOGY
Bandlaguda, Hyderabad-500 005.

Vysapuri, Bandlaguda Post:Keshavgi,ri,

Hyderabad-500 005, TELANGANA INDIA
Tel: 040-64596979,8978380692,Fax: 040-24455003
E-mail: a3hod.it@gmail.com,
Website: www.mist.ac.in,

MAHAVEER

INSTITUTE OF SCIENCE & TECHNOLOGY

Approved by AICTE, Affiliated to JNTUH,Hyd.



DEPARTMENT OF INFORMATION TECHNOLOGY

SUMMARY REPORT OF PYTHON PROGRAMMING

- Python programming language is considered as simple language as it extracts most of the concepts of C and Java in terms of syntax,
- Python programming is used to learn how to design, program the python applications and explains how to use lists, tuples and dictionaries in python programs
- It explains how to identify python objet types to use indexing and slicing to access data and also to define the structure and components of a python program
- It contains the concepts of loops and decision control statements and a parameter passing techniques
- It explains the concepts of packages and to read write into the python file, has beautiful concepts of inheriting a class and ability to handle the exceptions

COORDINATOR

Copy to:

1. Department Notice Board
2. Principal for Information
3. Committee Members (Academic)

PRINCIPAL
MAHAVEER
INSTITUTE OF SCIENCE & TECHNOLOGY
Bandlaguda, Hyd-500 005

MAHAVEER INSTITUTE OF SCIENCE & TECHNOLOGY
DEPARTMENT OF INFORMATION TECHNOLOGY
PYTHON PROGRAMMING ATTENDANCE SHEET

SNO	HALL TICKET	NAME OF THE STUDENT	Date															
			29/3	31	1	2	3	4	5	5	6	6	7	7	8			
1	17E31A1201	AKULA SAI JAHNAVI	P	P	P	P	P	P	P	P	P	P	P	P	P	P	P	P
2	17E31A1203	BAINGAR HARI PRASAD	A	P	A	P	A	P	A	P	A	P	A	P	A	P	A	P
3	17E31A1205	BHARADWAJ AJITH	P	P	P	P	P	P	P	P	P	P	P	P	P	P	P	P
4	17E31A1206	BOLLA KIRAN KUMAR	P	P	P	P	P	P	P	P	P	P	P	P	P	P	P	P
5	17E31A1207	C PRASHANSHA	A	P	A	P	A	P	A	P	A	P	A	P	A	P	A	P
6	17E31A1208	CEELA MAHESH	P	P	P	P	P	P	P	P	P	P	P	P	P	P	P	P
7	17E31A1209	GANDHAM SHYAMALA	P	P	P	P	P	P	P	P	P	P	P	P	P	P	P	P
8	17E31A1210	KAAVATI VINEETHA	P	P	P	P	P	P	P	P	P	P	P	P	P	P	P	P
9	17E31A1211	KAKANI HIMA BINDU	P	P	P	P	P	P	P	P	P	P	P	P	P	P	P	P
10	17E31A1212	KANDUKURI VINITHA	P	P	P	P	P	P	P	P	P	P	P	P	P	P	P	P
11	17E31A1213	LAKSHIKA PAREEK	P	P	P	P	P	P	P	P	P	P	P	P	P	P	P	P
12	17E31A1214	LOKA SAMHITHA	P	P	P	P	P	P	P	P	P	P	P	P	P	P	P	P
13	17E31A1215	MADISHETTY BRAAVYA SRI	P	P	P	P	P	P	P	P	P	P	P	P	P	P	P	P
14	17E31A1217	MARAM AKSHITHA	P	P	P	P	P	P	P	P	P	P	P	P	P	P	P	P
15	17E31A1218	MEKA SRIRUSHNA	P	P	P	P	P	P	P	P	P	P	P	P	P	P	P	P
16	17E31A1219	MIRYALA MOUNIKA	P	P	P	P	P	P	P	P	P	P	P	P	P	P	P	P
17	17E31A1220	MOHAMMED ABDUL RAZZAK	P	P	P	P	P	P	P	P	P	P	P	P	P	P	P	P
18	17E31A1221	MOHAMMED JAWAD	P	P	P	P	P	P	P	P	P	P	P	P	P	P	P	P
19	17E31A1222	MOHD HUSSAIN UDDIN	P	P	P	P	P	P	P	P	P	P	P	P	P	P	P	P
20	17E31A1223	MOHD MOIN UDDIN SIDDIQUI	A	P	A	P	A	P	A	P	A	P	A	P	A	P	A	P
21	17E31A1227	PATHA SAIKIRAN	P	P	P	P	P	P	P	P	P	P	P	P	P	P	P	P
22	17E31A1229	RAVUTLA PRANEETH	P	P	P	P	P	P	P	P	P	P	P	P	P	P	P	P
23	17E31A1230	SAMA NAVYA	P	P	P	P	P	P	P	P	P	P	P	P	P	P	P	P
24	17E31A1231	TUMMA NISHANTH KUMAR	P	P	P	P	P	P	P	P	P	P	P	P	P	P	P	P
25	17E31A1232	VIDHYADAR SHARMA P	P	P	P	P	P	P	P	P	P	P	P	P	P	P	P	P
26	17E31A1233	YASMEEN BEGUM	P	P	P	P	P	P	P	P	P	P	P	P	P	P	P	P
27	16E31A1215	MOHD SALMAN	P	P	P	P	P	P	P	P	P	P	P	P	P	P	P	P
28	18E31A1201	AFRAH MOHAMMADI	P	P	P	P	P	P	P	P	P	P	P	P	P	P	P	P
29	18E31A1202	AINDLA ABHISHEK	A	A	P	A	A	P	A	A	P	A	A	P	A	A	P	A



ESTD : 2001

MAA VAEEER INSTITUTE OF SCIENCE & TECHNOLOGY

Approved by AICTE, Affiliated to JNTU, Hyderabad.

Vysapuri, Bandlaguda, Post: Keshaugiri, Hyderabad-500 005

DEPARTMENT OF INFORMATION TECHNOLOGY



CERTIFICATE

This is to certify that **RAGHAVENDAR REDDY B** bearing Hall Ticket No **18E31A1223** of **B.Tech Third Year** has participated In **PYTHON PROGRAMMING** training Program From 29-12-2020 to 08-01-2021 organized by Dept. of **INFORMATION TECHNOLOGY**.

PRINCIPAL
MAA VAEEER
INSTITUTE OF SCIENCE & TECHNOLOGY
Vysapuri, Bandlaguda, Hyderabad-500 005.

Dr. Nanda Gopal Reddy
HOD

Puja Bhatia
Director/Webtek Labs. Pvt. Ltd.

Dr. K.S.S.S.N Reddy
PRINCIPAL

About the College

As an Institute committed in quality education, MAHVEER aims at providing learning with a Technology-edges. It endeavours to provide consistent training to the students to help them evolve as competent professionals in the highly competitive world. Right from its inception in 2004, it has been tuning itself to meet this objective. A new evolution is envisaging in our lives. This evolution begins with a new way of working. Millions are already tuning their lives to the rhythms of tomorrow.

About IT Dept.

The Department of IT was established in the year 2005 and carries the thrust of knowledge of students effectively which meets the highest level of competency required by the industry. With its experienced faculty members having excellent academic backgrounds, its trainers conduct supplementing classroom lectures with computer-aided demonstrations making their learning a rich, rewarding experience.

About the Course

Python is an extensive programming language that is majorly used for Rapid Application Development (RAD), prototyping, data analysis, artificial intelligence and scientific computing. It is one of the most simple and straightforward programming languages to learn with an easy syntax. Digital Nest, a Python training Institute in Hyderabad, has curated the best industry-oriented python training course structure, including practical learning and implementation methodology. The python course trainers hail from MAHVEER with immense knowledge, command over the programming language and hold years of

Organising committee

CHIEF PATRON

Smt. S. Jayalakshmi Reddy

Chairman

Sri.S.Surendar Reddy

Secretary

Sri S. Dhanunjay Reddy

Joint Secretary

DIRECTOR

Dr. H. S. N. Murthy

PATRON

Dr B. Nageshwar Rao,Principal

CONVENER

Dr.Nandagopal Reddy, Asso.Prof,

Dept. of IT

PROGRAM COORDINATORS

Mr.Siddi Srinivas

Mr.V.Narash Kumar Reddy



MAHAVEER

INSTITUTE OF SCIENCE & TECHNOLOGY

Approved by AICTE, Bangalore in 1999, for awarding
Bachelor's Degree in Computer Science, IT and Information
Technology.



Two week

Certification Course

on

PYTHON

PROGRAMMING

Organized by

Department of

Information Technology

Principal
Dr. H. S. N. Murthy
Dr. Nandagopal Reddy
Dr. B. Nageshwar Rao
Dr. S. S. Srinivas
Dr. V. Narash Kumar Reddy

MAHVEER
INSTITUTE OF SCIENCE & TECHNOLOGY
BANGALORE
1999

Schedule

- Day 1 : Introduction
- Day 2 : Functions
- Day 3 : Modules
- Day 4 : Sequences, iteration and string formatting
- Day 5: Dictionaries, sets and files
- Day 6 : Exceptions, testing, comprehensions
- Day 7 : Advanced argument passing
- Day 8: Lambda - functions as objects
- Day 9 : Object oriented programming
- Day 10 : Properties, special methods
- Day 11 : Iterators, iterables and generators
- Day 12 : Decorators, context managers
- Day 13 : Regular expressions

Contact details

KBVK Nagasree : 8179727092
K.Priyanka : 9121044296

Who can attend

3rd and Final Year IT students

Date: 29-12-2020 onwards

Time:

10am - 11:30am
12pm - 1:30pm

Place: MIST

NOTE : Participation Certificate will be given

Resource person

Dr .P. Srinivasa Rao

Ph.D
Professor,HOD
Department of CSE
JBIET

L.Raghu Kumar

M.Tech(Ph.D)
Associate Professor
Department of CSE
KG Reddy College of Engineering & Technology

K.Param Joshi

M.Tech
Assistant Professor
Department of CSE
Otam University

K.Bhaskar

M.Tech
Assistant Professor
Dept of CSE
JBIET

DR. P. SRINIVASA RAO
HOD, DEPARTMENT OF CSE
JBIET

JBIET
Jawahar Institute of Engineering & Technology
Bapatla, Andhra Pradesh - 522 202

Vysapuri, Bandlaguda Post: Keshavgiri,

Hyderabad-500 005, TELANGANA INDIA
Tel: 040-64596979,8978380692 Fax: 040-24465003
E-mail: ejhod.it@gmail.com,
Website: www.mist.ac.in,

MAHAVEER

INSTITUTE OF SCIENCE & TECHNOLOGY
Approved by AICTE. Affiliated to JNTUH,Hyd.



DEPARTMENT OF INFORMATION TECHNOLOGY

Date: 25-05-2021

To,

The principal,
MIST,
Hyderabad.

Sub: Proposal for Add-on Course-Reg.

Dear Sir,

We are going to conduct two weeks workshop on Advance Java and J2EE using Eclipse. We require your approval to go head for further proceeding and hope to get an opportunity to serve you the best.

With thanks and Regards

PRINCIPAL
MAHAVEER
INSTITUTE OF SCIENCE & TECHNOLOGY
Bandlaguda, Hyderabad-500 005.

Vysapuri, Bandlaguda Post: Keshavnagar,

Hyderabad-500 005, TELANGANA INDIA
Tel: 040-64596979, 8978380692, Fax: 040-24455003
E-mail: e3hod.it@gmail.com,
Website: www.mist.ac.in,

MAHAVEER

INSTITUTE OF SCIENCE & TECHNOLOGY

Approved by AICTE, Affiliated to JNTUH, Hyd.



DEPARTMENT OF INFORMATION TECHNOLOGY

Date: 01-06-2021

CIRCULAR

Technical Trainings for II & IV B. Tech students are starting from 07-06-2021 onwards. All HODs and placements coordinators have to manage the trainings and ensure 95% attendance all through the sessions.

All mentors need to send the compiled feedback report to HOD at e3hod@gmail.com daily. Mentors are advised to take care of PNR (Students not participating in training).

Agenda: **Advance Java and J2EE using Eclipse**

Design and Development of Curriculum for Add on Course:

Name of the Faculty: 1. Dr. A. NANDA GOPAL REDDY
2. S. SRINIVAS
3. B. MALLAIAH

Dr. A. Nanda Gopal Reddy
HOD, Dept. of IT
Mahaveer Institute of Science & Technology
Vysapuri, Bandlaguda Post, Keshavnagar
Hyderabad-500 005

PRINCIPAL
MAHAVEER
INSTITUTE OF SCIENCE & TECHNOLOGY
Bandlaguda Post, Hyderabad-500 005

Vysapuri, Bandlaguda Post:Keshavgi.

MAHAVEER



Hyderabad-500 005, TELANGANA INDIA
Tel: 040-64596979,8978380692 Fax: 040-24455003
E-mail: e3hod.it@gmail.com,
Website: www.mist.ac.in.

Approved by AICTE, Affiliated to JNTUH,Hyd.

DEPARTMENT OF INFORMATION TECHNOLOGY

SYLLABUS FOR Advance Java and J2EE using Eclipse

SNO	TOPIC COVERED	DURATION
1	Basics of a Web application	3
2	Web Container and Web Application Project Set up	3
3	Servlets	3
4	Session Management	3
5	JSPs	3
6	JSP Elements	3
7	JSP Tag library	3
8	Enterprise JavaBeans (EJB)	3
9	Java Message Service (JMS)	3
10	Java Naming and Directory Interface (JNDI)	3
11	Java Database Connectivity (JDBC)	3
12	Eclipse IDE	3

[Handwritten Signature]
HOD-IT

[Handwritten Signature]
MAHAVEER
INSTITUTE OF TECHNOLOGY & RESEARCH
BANDLAGUDA, HYD-500 005

Vysapuri, Bandlaguda Post, Kesabavgirl,

MAHAVEER



Hyderabad-500 005, TELANGANA INDIA

Tel: 040-64596979, 8978380692 Fax: 040-24455003

E-mail: e3hod.it@gmail.com.

Website: www.mist.ac.in.

Approved by AICTE, Affiliated to JNTUH, Hyd.

DEPARTMENT OF INFORMATION TECHNOLOGY

LIST OF REGISTERED STUDENTS FOR Advance Java and J2EE using Eclipse

SNO	HALL TICKET NO	NAME OF THE STUDENT
1	17E31A1201	AKULA SAI JAHNAVI
2	17E31A1203	KAINGAR HARI PRASAD
3	17E31A1205	DHARADWAJ AHHI
4	17E31A1206	BOLLA KIRAN KUMAR
5	17E31A1207	C PRASHANSHA
6	17E31A1208	CEELA MAHESH
7	17E31A1209	GANDHAM SITYAMALA
8	17E31A1210	KAAYATHI VINEETHA
9	17E31A1211	KAKANI HIMA BINDU
10	17E31A1212	KANDUKURI VINITHA
11	17E31A1213	LAKSHIKA PAREEK
12	17E31A1214	LOKA SAMITHA
13	17E31A1215	MADHSETTY BHAVYA SRI
14	17E31A1217	MARAM AKSHITHA
15	17E31A1218	MEKA SRIKRISHNA
16	17E31A1219	MIRYALA MOUNIKA
17	17E31A1220	MOHAMMED ABDUL RAZZAK
18	17E31A1221	MOHAMMED JAWAD
19	17E31A1222	MOHD HUSSAIN UDDIN
20	17E31A1223	MOHD MOIN UDDIN SIDDIQUI
21	17E31A1227	PATHA SAIKIRAN
22	17E31A1229	RAVUTLA PRANEETH
23	17E31A1230	SAMA NAVYA
24	17E31A1231	TUMMA NISHANTH KUMAR
25	17E31A1232	VIDHYADAR SHARMA P
26	17E31A1233	YASMEEN BEGUM
27	16E31A1215	MOHD SALMAN
28	19E31A1201	ANISHETTY VARSHITHA
29	19E31A1202	ANNARAPU NITHIN REDDY
30	19E31A1203	U KAIYAN
31	19E31A1204	BEDJAPU PAVANKALYAN
32	19E31A1205	BHEEM REDDY SHASHANK REDDY
33	19E31A1206	DONTHI MADHURI
34	19E31A1207	GANDLA SAI SIDDHARTHA
35	19E31A1208	GOPU AASHISH
36	19E31A1209	GOTTIPARTHI AKASH
37	19E31A1210	GOULLA RAJA RAGHAVENDAR REDDY
38	19E31A1211	KARNE MANIKANTA
39	19E31A1212	KATIPALLY SAMPATH REDDY
40	19E31A1213	LINGALA NAVEEN
41	19E31A1214	MANDA VAMSHIDHAR REDDY
42	19E31A1215	MUDUGANTI BHANU PRAKASH REDDY
43	19E31A1216	MULUGU SRI VEERABHADRA KARTHIK
44	19E31A1217	NALLA SATHVIK REDDY
45	19E31A1218	NALLANI SADVINI

PRINCIPAL
MAHAVEER
INSTITUTE OF TECHNOLOGY & MANAGEMENT
Bandlaguda Post, Kesabavgirl, Hyderabad-500 005

Vysapuri, Bandlaguda Post:Keshavgirl,

MAHAVEER



Hyderabad-500 005, TELANGANA INDIA
Tel: 040-64596979,8978380692 Fax: 040-24455003
E-mail: e3hod.it@gmail.com,
Website: www.mist.ac.in

Approved by AICTE, Affiliated to JNTUH,Hyd.

DEPARTMENT OF INFORMATION TECHNOLOGY

46	19E31A1219	PAHIRELLY DEEPOVATEJA
47	19E31A1220	RAVURI RAMYA SRI
48	19E31A1221	SAIRI LAXMI PRASANNA
49	19E31A1222	SANKU DEEKSHATHIMIKA
50	19E31A1223	SEELAM SAI CHARAN REDDY
51	19E31A1224	SHAGUFTA MAHMOOD
52	19E31A1225	SHAIKH MUHAMMED AMER
53	19E31A1226	TANGELLAMUDI SAITEJA
54	19E31A1227	TIGULLA SHIVA KUMAR
55	19E31A1228	VADLA VYSHNAVI
56	19E31A1229	VEMPATI NAVYA TEJ
57	19E31A1230	VENGALA ABHIRAM
58	19E31A1231	NABEELA KALEEM
59	18E31A1204	A HARSHITH REDDY
60	18E31A1217	MIR ZAKI UDDIN ALI KHAN
61	18E31A1224	SOHAIL FAHEEMILLAH SHAREEF
62	17E31A1202	ASETHU MADHAV
63	18E31A1225	SYED TURAB ALI
64	20E35A1201	CHEEMA RAMYA
65	20E35A1202	G SAI KIRAN
66	20E35A1203	MD MANSOOR
67	20E35A1204	SACHIN KUMAR

Handwritten signature

Handwritten signature

PRINCIPAL
MAHAVEER
INSTITUTE OF TECHNOLOGY & MANAGEMENT
Bandlaguda, Hyd-500 005.

Vysapuri, Bandlaguda Post:Keshavgiri.

MAHAVEER

INSTITUTE OF STUDIES & RESEARCH
Approved by AICTE, Affiliated to JNTUH,Hyd.



Hyderabad-500 005, TELANGANA INDIA
Tel: 040-64596979,8978380692,Fax: 040-24455003
E-mail: e3hod.it@gmail.com,
Website: www.mist.ac.in.

DEPARTMENT OF INFORMATION TECHNOLOGY

Advance Java and J2EE using Eclipse QUESTION PAPER

Duration: 120 Minutes

8 X 2.5 = 20 Marks

Answer the following all questions. Each question carries 2.5 marks.

1. How do client and server communicate?
2. How to set up a Servlets JSP project in Eclipse.
3. What are Servlets?
4. Explain Servlet Lifecycle
5. Describe Servlet Context and Servlet Config
6. Explain forwarding and Redirection of requests
7. What is a session?
8. Explain Session information passing mechanisms - Cookies, Rewriting

Dr. A. Anjan - Coord. Dept.
HOD, Dept. of Info. Tech. & Systems
Mahaveer Institute of Studies & Research
Vysapuri, Bandlaguda, Post: Keshavgiri,
Hyderabad-500 005.

PRINCIPAL
MAHAVEER
INSTITUTE OF STUDIES & RESEARCH
Bandlaguda, Hyd-500 005

Vysapuri, Bandlaguda Post, Keshavgi,

MAHAVEER



Hyderabad-500 005, TELANGANA INDIA
Tel: 040-64596979,8978386692 Fax: 040-24455003
E-mail: e3hod.it@gmail.com
Website: www.mist.ac.in

Approved by AICTE, Affiliated to JNTUH,Hyd.

DEPARTMENT OF INFORMATION TECHNOLOGY

RESULT SHEET FOR Advance Java and J2EE using Eclipse REGISTERED STUDENTS

SNO	HALL TICKET NO	NAME OF THE STUDENT	MARKS (20)	RESULT
1	17E31A1201	AKULA SAI JAHNAVI	20	PASS
2	17E31A1203	BAINGAR HARI PRASAD	19	PASS
3	17E31A1205	BIHARADWAJ AJITH	20	PASS
4	17E31A1206	BOLLA KIRAN KUMAR	18	PASS
5	17E31A1207	C PRASHANSHA	20	PASS
6	17E31A1208	CEELA MAHESH	20	PASS
7	17E31A1209	GANDHAM SHYAMALA	16	PASS
8	17E31A1210	KAAVATI VINEETHA	20	PASS
9	17E31A1211	KAKANI HIMA BINDU	20	PASS
10	17E31A1212	KANDUKURI VINITHA	17	PASS
11	17E31A1213	LAKSHIKA PAREEK	20	PASS
12	17E31A1214	LOKA SAMHITHA	20	PASS
13	17E31A1215	MADISHETTY BHAVYA SRI	16	PASS
14	17E31A1217	MARAM AKSHITHA	20	PASS
15	17E31A1218	MEKA SRIKRISHNA	20	PASS
16	17E31A1219	MIRYALA NOUNIKA	18	PASS
17	17E31A1220	MOHAMMED ABDUL RAZZAK	20	PASS
18	17E31A1221	MOHAMMED JAWAD	19	PASS
19	17E31A1222	MOHD HUSSAIN UDDIN	20	PASS
20	17E31A1223	MOHD MOIN UDDIN SIDDIQUI	18	PASS
21	17E31A1227	PATHA SAJKIRAN	20	PASS
22	17E31A1229	RAVUTLA PRANEETHI	20	PASS
23	17E31A1230	SAMA NAVYA	16	PASS
24	17E31A1231	TUMMA NISHANTH KUMAR	20	PASS
25	17E31A1232	VIDHYADAR SHARMA P	20	PASS
26	17E31A1233	YASMEEN BEGUM	20	PASS
27	16E31A1215	MOHD SALMAN	18	PASS
28	19E31A1201	ANISHETTY VARSHITHA	20	PASS
29	19E31A1202	ANNARAPU NITHIN REDDY	19	PASS
30	19E31A1203	B KALYAN	20	PASS
31	19E31A1204	BEJJARAPU BAWANKALYAN	18	PASS
32	19E31A1205	BHEEM REDDY SHASHANK REDDY	20	PASS
33	19E31A1206	DONTHI MADHURI	20	PASS
34	19E31A1207	GANDLA SAI SIDDHARTHA	16	PASS
35	19E31A1208	GOPU AASHISH	20	PASS
36	19E31A1209	GOTTIPARTHI AKASH	20	PASS
37	19E31A1210	GOULLA RAJA RAGHAVENDAR REDDY	17	PASS
38	19E31A1211	KARNE MANIKANTA	20	PASS
39	19E31A1212	KATIPALLY SAMPATH REDDY	20	PASS
40	19E31A1213	LINGALA NAVEEN	16	PASS
41	19E31A1214	MANDA VAMSHIDHAR REDDY	20	PASS
42	19E31A1215	MUDUGANTI BHANU PRAKASH REDDY	20	PASS
43	19E31A1216	MULLIGU SRI VEERABHADRA KARTHIK	18	PASS

MAHAVEER
INSTITUTE OF TECHNOLOGY
Bandlaguda, Hyd-500 005

Vysapuri, Bandlaguda Post-Keshavgiri,

MAHAVEER

INSTITUTE OF STUDIES & TECHNOLOGY

Approved by AICTE. Affiliated to JNTUH,Hyd.



Hyderabad-500 005, TELANGANA INDIA

Tel: 040-64596979,8978380692,Fax: 040-24455003

E-mail: eg3hod.it@gmail.com,

Website: www.mist.ac.in,

DEPARTMENT OF INFORMATION TECHNOLOGY

44	19E31A1217	NALLA SATHYK REDDY	20	PASS
45	19E31A1218	NALLANI SADVINI	19	PASS
46	19E31A1219	PAIDIPETLY DHIRUVALEJA	20	PASS
47	19E31A1220	RAVURI RAMYA SRI	18	PASS
48	19E31A1221	SAIRI LAXMI PRASANNA	20	PASS
49	19E31A1222	SANKU DFEKSHATHMIKA	20	PASS
50	19E31A1223	SEELAM SAI CHARAN REDDY	16	PASS
51	19E31A1224	SHAGUFTA MAHMOOD	20	PASS
52	19E31A1225	SHAIKH MUHAMMED AMER	20	PASS
53	19E31A1226	TANGELLAMUDI SAITEJA	20	PASS
54	19E31A1227	TIGULLA SHIVA KUMAR	18	PASS
55	19E31A1228	VADLA VYSHNAVI	19	PASS
56	19E31A1229	VEMPATI NAVYA TEJ	20	PASS
57	19E31A1230	VENGALA ABHIRAM	18	PASS
58	19E31A1231	NABEELA KALEEM	17	PASS
59	18E31A1204	A HARSHITH REDDY	16	PASS
60	18E31A1217	MIR ZAKI UDDIN ALI KHAN	20	PASS
61	18E31A1224	SOHAIL FAHEEMILLAH SHAREEF	20	PASS
62	17E31A1202	ASETHU MADHAV	20	PASS
63	18E31A1225	SYED TURAB ALI	18	PASS
64	20E35A1201	CHEEMA RAMYA	19	PASS
65	20E35A1202	G SAI KIRAN	20	PASS
66	20E35A1203	MD MANSOOR	18	PASS
67	20E35A1204	SACHIN KUMAR	17	PASS

No. of students Registered:67

No. of students Passed:67

No. of students failed:Nil.

PRINCIPAL
MAHAVEER
INSTITUTE OF STUDIES & TECHNOLOGY
Bandlaguda, Hyd-500 005.

Vysapuri, Bandlaguda Post:Keshavgiri,

Hyderabad-500 005, TELANGANA INDIA
Tel: 040-64596979,8978380692 Fax: 040-24455003
E-mail: a3hod.it@gmail.com,
Website: www.mist.ac.in,

MAHAVEER

INSTITUTE OF SCIENCE & TECHNOLOGY
Approved by AICTE, Affiliated to JNTUH,Hyd.



DEPARTMENT OF INFORMATION TECHNOLOGY

SUMMARY REPORT OF Advance Java and J2EE using Eclipse

- Java programming language is considered as single language as it extracts most of the concepts of C and C++ in terms of syntax.
- Java programming is used to learn how to design, program the web applications and explains how to use web applications.
- It explains how to identify java object types to use indexing and slicing to access data and also to define the structure and components of a java program
- It explains the concepts of packages and to read write into the java file, has beautiful concepts of inheriting a class and ability to handle the exceptions

COORDINATOR

Copy to:

1. Department Notice Board
2. Principal for Information
3. Committee Members (Academic)

PRINCIPAL
MAHAVEER
INSTITUTE OF SCIENCE & TECHNOLOGY
Bandlaguda, Hyd-500 005

MALAYALAM INSTITUTE OF SCIENCE & TECHNOLOGY
DEPARTMENT OF INFORMATION TECHNOLOGY
Advance Java and J2EE using Eclipse ATTENDANCE SHEET

SNO	HALL TICKET	NAME OF THE STUDENT	Date	7	8	9	10	11	12	13	14	15	16	17	18	19
1	17E31A1201	AKULA SAI JAINAVI		P	P	P	P	P	P	P	P	P	P	P	P	P
2	17E31A1203	BAINGAR HARI PRASAD		P	P	P	P	P	P	P	P	P	P	P	P	P
3	17E31A1205	BHARADWAJ AJITH		P	P	P	P	P	P	P	P	P	P	P	P	P
4	17E31A1206	BOLLA KIRAN KUMAR		P	P	P	P	P	P	P	P	P	P	P	P	P
5	17E31A1207	C PRASHANSHA		P	P	P	P	P	P	P	P	P	P	P	P	P
6	17E31A1208	CEELA MAHESH		P	P	P	P	P	P	P	P	P	P	P	P	P
7	17E31A1209	GANDHAM SHYAMALA		P	P	P	P	P	P	P	P	P	P	P	P	P
8	17E31A1210	KAAVATI VINEETHA		P	P	P	P	P	P	P	P	P	P	P	P	P
9	17E31A1211	KAKANI HIMA BINDU		P	P	P	P	P	P	P	P	P	P	P	P	P
10	17E31A1212	KANDUKURI VINITHA		P	P	P	P	P	P	P	P	P	P	P	P	P
11	17E31A1213	LAKSHIKA PAREEK		P	P	P	P	P	P	P	P	P	P	P	P	P
12	17E31A1214	LOKA SAMHITHA		P	P	P	P	P	P	P	P	P	P	P	P	P
13	17E31A1215	MADISHETTY BHAVYA SRI		P	P	P	P	P	P	P	P	P	P	P	P	P
14	17E31A1217	MARAM AKSHITHA		P	P	P	P	P	P	P	P	P	P	P	P	P
15	17E31A1218	MEKA SRIKRISHNA		P	P	P	P	P	P	P	P	P	P	P	P	P
16	17E31A1219	MIRYALA MOUNIKA		P	P	P	P	P	P	P	P	P	P	P	P	P
17	17E31A1220	MUHAMMED ABDUL KAZZAK		P	P	P	P	P	P	P	P	P	P	P	P	P
18	17E31A1221	MUHAMMED JAWAD		P	P	P	P	P	P	P	P	P	P	P	P	P
19	17E31A1222	MOHD HUSSAIN UDDIN		P	P	P	P	P	P	P	P	P	P	P	P	P
20	17E31A1223	MOHD MOIN UDDIN SIDDIQUI		P	P	P	P	P	P	P	P	P	P	P	P	P
21	17E31A1227	PATHA SAIKIRAN		P	P	P	P	P	P	P	P	P	P	P	P	P
22	17E31A1229	RAVUTHA PRANEETHI		P	P	P	P	P	P	P	P	P	P	P	P	P
23	17E31A1230	SAMA NAVYA		P	P	P	P	P	P	P	P	P	P	P	P	P
24	17E31A1231	TUMMA NISHANTH KUNJAR		P	P	P	P	P	P	P	P	P	P	P	P	P
25	17E31A1232	VIDHYADAR SHARMA P		P	P	P	P	P	P	P	P	P	P	P	P	P
26	17E31A1233	YASMEEN BEGUM		P	P	P	P	P	P	P	P	P	P	P	P	P
27	16E31A1215	MOHD SALMAN		P	P	P	P	P	P	P	P	P	P	P	P	P
28	19E31A1201	ANISHETTY VARSHITHA		P	P	P	P	P	P	P	P	P	P	P	P	P

 Head of Department
 Department of Information Technology
 Malayalam Institute of Science & Technology



ESTD : 2001

MAHAVEER INSTITUTE OF SCIENCE & TECHNOLOGY

Approved by AICTE, Affiliated to JNTU, Hyderabad.

Vyasapur, Bandlaguda, Post: Keshavnagar, Hyderabad - 500 005

DEPARTMENT OF INFORMATION TECHNOLOGY





CERTIFICATE

This is to certify that **MULUGU SRI VEERABHADRA KARTHIK** bearing Hall Ticket No **19E31A1216** of **B.Tech Second Year** has participated In **Advance Java and J2EE** using **Eclipse** training Program From **07-06-2021** to **19-06-2021** organized by

Dept. of INFORMATION TECHNOLOGY.

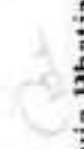
Dr. Nandya Gopal Reddy
HOD

Puja Bhunia
Director/Webtek Labs. Pvt. Ltd.

Dr. K. S. S. N. Reddy
PRINCIPAL



DEPARTMENT OF AERONAUTICAL ENGINEERING

PROPOSAL LETTER

Hyderabad,

16/09/2020.

To,
The principal,
MIST,
Hyderabad.

Sub: Proposal for two weeks workshop on **Micro Category Multirotor Drone Pilot course**—

Reg,

Dear Sir,

We are working as Asst professor in the department of AERONAUTICAL ENGINEERING.
Sir, we are going to conduct three weeks workshop **Micro Category Multirotor Drone Pilot course**. We require your approval to go head for further proceeding and hope to get an opportunity to serve you the best.

With thanks and Regards

PRINCIPAL
MAHAVEER
INSTITUTE OF SCIENCE & TECHNOLOGY
BANDLAGUDA, HYD-500 005.

From,
AERO Department
Mist,
Bandlaguda,





DEPARTMENT OF AERONAUTICAL ENGINEERING

Date: 23.09.2020

CIRCULAR

Technical Training for II B, Tech students are starting from 1st July, 2020 onwards. All HODs and Placements coordinators have to manage the trainings and ensure 95% attendance all through the sessions.

All Mentors need to send the compiled feedback report to A RANGA REDDY, HOD at e3hod.aero@gmail.com daily.

Agenda: Micro Category Multirotor Drone Pilot course

A RANGA REDDY
HOD

Course Designed By

Dr SR DHINESH KUMAR
N MAHESH

PRINCIPAL
MAHAVEER
INSTITUTE OF AERONAUTICAL & TECHNOLOGY
Bandlaguda, Hyderabad-500 005.



Course: Micro Category Multirotor Drone Pilot Course

SYLLABUS

1: Introduction to Multirotor Drones, DGCA Regulations

- Regulations of DGCA
- Basic Principles of Flight
- Multirotor Introduction
- Drone Equipment Maintenance

2: Introduction to Flight Simulator Training

- Introduction to Flight Simulator
- Flight Simulator Training

3: Important Parts and Components in a Multirotor

- Drone Assembling
- Identification of each component in a Multirotor Assembling and calibrating
- Practical flying with instructor

PRINCIPAL
MAHAVEER
INSTITUTE OF SCIENCE & TECHNOLOGY
BANDLAGUDA, HYD-500 006.

Vysapuri, Bandlaguda Post:Keshavgiri,
Hyderabad-500 005, Telangana INDIA
Tel: 040-64596979,20020773, Fax: 040-24455003
E-mail: principalmahaveer@gmail.com,
Website: www.mist.ac.in.

MAHAVEER

Approved by AICTE, Affiliated to JNTUH Hyd.



STUDENT LIST (2020-21)

S.No	Hall Ticket No	Name of the Candidate	YEAR
1	19E31A2101	ACHANTA KUMAR	II
2	19E31A2102	BANOTH GOPI KRISHNA	II
3	19E31A2103	CHILUKA VISHNU VARDHAN	II
4	19E31A2104	GATTU MANISH	II
5	19E31A2105	GATTU SANJEEV KUMAR	II
6	19E31A2106	GOLUSULA NAVEEN KUMAR	II
7	19E31A2107	GORANTALA SUPRABHATH DHANUSH	II
8	19E31A2108	GOSHA SHREEMANTH	II
9	19E31A2109	K KOUSHIK	II
10	19E31A2110	KALA BHAVANI	II
11	19E31A2111	KASARLA PRABHAS REDDY	II
12	19E31A2112	KOTAGIRI SRIJAN	II
13	19E31A2113	LANKA TEJA	II
14	19E31A2114	LINGALA ADI GOUD	II
15	19E31A2115	MACCHA TARUNTEJA	II
16	19E31A2116	MOHAMMED ABDUL QAWI	II
17	19E31A2117	MOHAMMED AHMED	IV
18	19E31A2118	MOHAMMED ASLAM MUSHTAQ	II

PRINCIPAL
MAHAVEER
INSTITUTE OF SCIENCE & TECHNOLOGY
BANDLAGUDA, HYD-500 005

S. Somashekhar
Hop

Vysapuri, Sandlaguda Post, Keshavgiri,
Hyderabad-500 005, Telangana INDIA
Tel: 040-64596979, 20020773, Fax: 040-24455003
E-mail: principal.mahaveer@gmail.com
Website: www.misl.ac.in

MAHAVEER

INSTITUTE OF SCIENCE & TECHNOLOGY
Approved by AICTE, Affiliated to JNTUH, Hyd.



19	19E31A2119	MOHAMMED IMRAN UDDIN	II
20	19E31A2120	MOHAMMED JAMAL UMAIR	II
21	19E31A2121	MOHAMMED KHADER AHMED	II
22	19E31A2122	MOHAMMED SULEMAN ULLAH KHAN	II
23	19E31A2123	MOHD SAIF UDDIN MERAJ	II
24	19E31A2124	MURIKINATI RAJESWARI	II
25	19E31A2126	NALLAM TANUSREE	II
26	19E31A2127	RUDRA AKANKSHA	II
27	19E31A2128	S SHALINI	II
28	19E31A2129	SRAVAN KUMAR SINGH	II
29	19E31A2132	KOYYADA SINDHUJA	II
30	20E35A2102	CHIRALA SAI KIRAN	II
31	20E35A2103	DARMAJI PAVAN KUMAR	II
32	20E35A2104	KOMALA SREYAS	II
33	20E35A2105	MADHUNALA REVANTH KIIMAR	II

PRINCIPAL
MAHAVEER
INSTITUTE OF SCIENCE & TECHNOLOGY
Sandlaguda, Hyderabad 500 005

HOD

Vysapuri, Bandlaguda Post:Keshavgiri,
Hyderabad-500 005, Telangana INDIA
Tel: 040-64596979,20020773, Fax: 040-24455003
E-mail: principal.mahaveer@gmail.com,
Website: www.mist.ac.in,

MAHAVEER

INSTITUTE OF SCIENCE & TECHNOLOGY
Approved by AICTE, Affiliated to JNTUH,Hyd.



Technical Training Exam on Multi rotor Drone Pilot course

(A.Y-2020-21)

4x5=20 Marks

Answer All the Questions Multirotor Drone Pilot Course

1. Basic Principles of Flight?
2. Multi rotor Introduction?
3. Drone Equipment Maintenance?
4. Drone Assembling?

PRINCIPAL
MAHAVEER
INSTITUTE OF SCIENCE & TECHNOLOGY
Bandlaguda, Hyd-500 005.

Vysavuri, Bandlaguda Post:Keshavgirl,
Hyderabad-500 005, Telangana INDIA
Tel: 040-64596979,20620773, Fax: 040-24456003
E-mail: principal_mahaveer@gmail.com,
Website: www.mist.ac.in,

MAHAVEER



Approved by AICTE. Affiliated to JNTUH,Hyd

Training student marks list 2020-21

S.No	Hall Ticket No	Name of the Candidate	MARKS	PASS/FAIL
1	19E31A2101	ACHANTA KUMAR	16	PASS
2	19E31A2102	BANOTH GOPI KRISHNA	16	PASS
3	19E31A2103	CHILUKA VISHNU VARDHAN	18	PASS
4	19E31A2104	GATTU MANISH	19	PASS
5	19E31A2105	GATTU SANJEEV KUMAR	18	PASS
6	19E31A2106	GOLUSULA NAVEEN KUMAR	18	PASS
7	19E31A2107	GORANTALA SUPRABHATH DHANUSH	17	PASS
8	19E31A2108	GOSHA SHREEMANTH	15	PASS
9	19E31A2109	K KOUSHIK	16	PASS
10	19E31A2110	KALA BHAVANI	14	PASS
11	19E31A2111	KASARLA PRABHAS REDDY	15	PASS
12	19E31A2112	KOTAGIRI SRIJAN	16	PASS
13	19E31A2113	LANKA TEJA	14	PASS
14	19E31A2114	LINGALA ADI GOUD	18	PASS
15	19E31A2115	MACCHA TARUNTEJA	19	PASS
16	19E31A2116	MOHAMMED ABDUL QAWI	16	PASS
17	19E31A2117	MOHAMMED AHMED	18	PASS

PRINCIPAL
MAHAVEER
INSTITUTE OF TECHNOLOGY
BANDLAGUDA, HYDRABAD-500005

S. D. D. D.
Hop

Vysapuri, Bandlaguda Post, Keshavgiri,
Hyderabad-500 005, Telangana INDIA
Tel: 040-84596979, 20020773, Fax: 040-24455003
E-mail: principal.mahaveer@gmail.com,
Website: www.mist.ac.in

MAHAVEER



Approved by AICTE, Affiliated to JNTUH Hyd

18	19E31A2118	MOHAMMED ASLAM MUSHTAQ	19	PASS
19	19E31A2119	MOHAMMED IMRAN UDDIN	15	PASS
20	19E31A2120	MOHAMMED JAMAL UMAIR	14	PASS
21	19E31A2121	MOHAMMED KHADER AHMED	18	PASS
22	19E31A2122	MOHAMMED SULEMAN ULLAH KHAN	15	PASS
23	19E31A2123	MOHD SAIF UDDIN MERAJ	15	PASS
24	19E31A2124	MURIKINATI RAJESWARI	15	PASS
25	19E31A2126	NALLAM TANUSREE	16	PASS
26	19E31A2127	RUDRA AKANKSHA	15	PASS
27	19E31A2128	S SHALINI	18	PASS
28	19E31A2129	SRAVAN KUMAR SINGH	16	PASS
29	19E31A2132	KOYYADA SINDHUJA	18	PASS
30	20E35A2102	CHIRALA SAI KIRAN	15	PASS
31	20E35A2103	DARMAJI PAVAN KUMAR	16	PASS
32	20E35A2104	KOMALA SREYAS	19	PASS
33	20E35A2105	MADHUNALA REVANTH KUMAR	15	PASS

PRINCIPAL
MAHAVEER
INSTITUTE OF SCIENCE & TECHNOLOGY
Bandlaguda, Hyd-500 005

HOD

MARAVEER INSTITUTE OF SCIENCE AND TECHNOLOGY
AERONAUTICAL ENGINEERING

COURSE ATTENDANCE LIST

S NO	H T NO	NAME	Date	23	24	25	26	27	28	29	30	1	2	3	4	5	6	7
1	19E31A2101	ACHANTA KUMAR		P	P	P	P	P	P	P	P	P	P	P	P	P	P	P
2	19E31A2102	BANOTH GOPI KRISHNA		P	P	P	P	P	P	P	P	P	P	P	P	P	P	P
3	19E31A2103	CHILUKA VISHNU VARDHAN		P	P	P	P	P	P	P	P	P	P	P	P	P	P	P
4	19E31A2104	GATTU MANISH		P	P	P	P	P	P	P	P	P	P	P	P	P	P	P
5	19E31A2105	GATTU SANEEV KUMAR		P	P	P	P	P	P	P	P	P	P	P	P	P	P	P
6	19E31A2106	GOLLISILA NAVEEN KUMAR		P	P	P	P	P	P	P	P	P	P	P	P	P	P	P
7	19E31A2107	SORANTALA SUPRABHATH DHANUSH		P	P	P	P	P	P	P	P	P	P	P	P	P	P	P
8	19E31A2108	GOSHA SHREEMANTH		P	P	P	P	P	P	P	P	P	P	P	P	P	P	P
9	19E31A2109	K KOUSHIK		P	P	P	P	P	P	P	P	P	P	P	P	P	P	P
10	19E31A2110	KALA BHAVANI		P	P	P	P	P	P	P	P	P	P	P	P	P	P	P
11	19E31A2111	KASARLA PRABHAS REDDY		P	P	P	P	P	P	P	P	P	P	P	P	P	P	P
12	19E31A2112	KOTAGIRI SRUJAN		P	P	P	P	P	P	P	P	P	P	P	P	P	P	P
13	19E31A2113	LANKA TEJA		P	P	P	P	P	P	P	P	P	P	P	P	P	P	P
14	19E31A2114	LINGALA ADI GOUD		P	P	P	P	P	P	P	P	P	P	P	P	P	P	P
15	19E31A2115	MAJCHA TANUJEJA		P	P	P	P	P	P	P	P	P	P	P	P	P	P	P
16	19E31A2116	MOHAMMED ABDUL QAWI		P	P	P	P	P	P	P	P	P	P	P	P	P	P	P
17	19E31A2117	MOHAMMED AL-IMED		P	P	P	P	P	P	P	P	P	P	P	P	P	P	P
18	19E31A2118	MOHAMMED ASLAM MUSHTAQ		P	P	P	P	P	P	P	P	P	P	P	P	P	P	P
19	19E31A2119	MOHAMMED IMRAN UDDIN		P	P	P	P	P	P	P	P	P	P	P	P	P	P	P
20	19E31A2120	MOHAMMED AMAL UMAIR		P	P	P	P	P	P	P	P	P	P	P	P	P	P	P
21	19E31A2121	MOHAMMED KHADER AHMED		P	P	P	P	P	P	P	P	P	P	P	P	P	P	P
22	19E31A2122	MOHAMMED SULEMAN ULLAH KHAN		P	P	P	P	P	P	P	P	P	P	P	P	P	P	P
23	19E31A2123	MOHD SAIF UDDIN MERAJ		P	P	P	P	P	P	P	P	P	P	P	P	P	P	P
24	19E31A2124	MURIKRATH NAGESWARI		P	P	P	P	P	P	P	P	P	P	P	P	P	P	P
25	19E31A2125	NALLANI TANUSREE		P	P	P	P	P	P	P	P	P	P	P	P	P	P	P
26	19E31A2127	RUDRA AKANKSHA		P	P	P	P	P	P	P	P	P	P	P	P	P	P	P
27	19E31A2128	S SHALINI		P	P	P	P	P	P	P	P	P	P	P	P	P	P	P
28	19E31A2129	SRAVAN KUMAR SINGH		P	P	P	P	P	P	P	P	P	P	P	P	P	P	P
29	19E31A2132	KOTYADA SINDHRIA		P	P	P	P	P	P	P	P	P	P	P	P	P	P	P
30	20E15A2102	CHIRALA SAIBORAN		P	P	P	P	P	P	P	P	P	P	P	P	P	P	P

(Signature)
HOD

Vysapuri, Bandlaguda Post:Keshavgiri,
Hyderabad-500 005, Telangana INDIA
Tel: 040-64596979,20020773, Fax: 040-24455003
E-mail: principal.mahaveer@gmail.com
Website: www.mist.ac.in,

MAHAVEER

INSTITUTE OF SCIENCE & TECHNOLOGY
Approved by AICTE, Affiliated to JNTUH,Hyd.



Course : Micro Category Multi rotor Drone Pilot Course

Report summary

A multirotor or multicopter is a rotorcraft with more than two lift-generating rotors. An advantage of multirotor aircraft is the simpler rotor mechanics required for flight control. Unlike single- and double-rotor helicopters which use complex variable pitch rotors whose pitch varies as the blade rotates for flight stability and control, multirotors often use fixed-pitch blades; control of vehicle motion is achieved by varying the relative speed of each rotor to change the thrust and torque produced by each.

There are four main physical types of professional drones: multi-rotor, fixed-wing, single-rotor helicopter, and fixed-wing hybrid VTOL. The different body styles of each type of drone contribute to the amount of weight they can carry (payload), efficiency and duration of the flight.

A. Dossuley
HOD

[Signature]
PRINCIPAL
MAHAVEER
INSTITUTE OF SCIENCE & TECHNOLOGY
Bandlaguda, Hyderabad-500 005

Vysaguri, Bandlaguda Post:Keshavgi,
Hyderabad-500 005, Telangana INDIA
Tel: 040-64596979,20020773, Fax: 040-24455003
E-mail: principal.mahaveer@gmail.com
Website: www.mist.ac.in

MAHAVEER



Approved by AICTE, Affiliated to JNTU(H)Hyd.

CERTIFICATE OF COURSE COMPLETION

This certificate is presented to KALA BHAVANI of MIST, who has
successfully completed technical training course on “Micro Category
Multirotor Drone Pilot Course” held from 23-09-2020 to 07-10-2020 and
found the student performance to be excellent.



ESTD : 2001

A. Ranga Reddy

A RANGA REDDY

HOD (AERO)

[Signature]
PRINCIPAL
MAHAVEER
INSTITUTE OF SCIENCE & TECHNOLOGY
Bandlaguda, Hyderabad-500 005.

Vysapuri, Bandlaguda Post:Keshavgiri,

Hyderabad-500 005, TELANGANA INDIA

Tel: 040-64596979,8978380692,Fax: 040-24455003

E-mail: e3hod.it@gmail.com,

Website: www.mist.ac.in,

MAHAVEER
INSTITUTE OF SCIENCE & TECHNOLOGY

Approved by AICTE, Affiliated to JNTUH,Hyd.

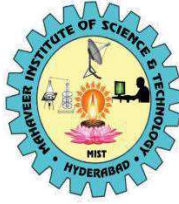

DEPARTMENT OF HUMANITIES AND SCIENCES

Date: 25-10-20

To,
The principal,
MIST ,
Hyderabad.

Sub: Proposal for Add-on-course-Reg

Dear sir,

We are going to conduct Add-On course on Ultrasonics. we require your approval to go head for further proceeding and hope to get an opportunity to serve you the best.

With thanks and Regards

PRINCIPAL
MAHAVEER
INSTITUTE OF SCIENCE & TECHNOLOGY
Bandlaguda, Hyd-500 005.

HOD
Department of Humanities & Sciences
Mahaveer Institute of Science & Technology,
HYDERABAD

Vysapuri, Bandlaguda Post:Keshavgi,

Hyderabad-500 005, TELANGANA INDIA
Tel: 040-64596979,8978380692,Fax: 040-24455003
E-mail: e3hod.it@gmail.com,
Website: www.mist.ac.in,

MAHAVEER
INSTITUTE OF SCIENCE & TECHNOLOGY
Approved by AICTE, Affiliated to JNTUH,Hyd.



DEPARTMENT OF HUMANITIES AND SCIENCES

Date: 25-10-20

CIRCULAR

CRASH COURSE FOR I B.Tech students are starting from 25-10-20 onwards. All HODs and placements coordinators have to manage the trainings and ensure 95% attendance all through the sessions.

All mentors need to send the compiled feedback report to HOD at e3hod@gmail.com daily. Mentors are advised to take care of PNR (Students not participating in training).

Agenda: **ULTRASONICS**

Design and Development of Curriculum for Add on Course

Name of Faculty: 1.Dr.K.MADHUSUDHANA
2.P.SRINIVAS KUMAR



PRINCIPAL
MAHAVEER
INSTITUTE OF SCIENCE & TECHNOLOGY
Bandlaguda, Hyd-500 005.



HOD
Department of Humanities & Sciences
Mahaveer Institute of Science & Technology,
HYDERABAD

Vysapuri, Bandlaguda Post:Keshavgi,

Hyderabad-500 005, TELANGANA INDIA
Tel: 040-64596979,8978380692,Fax: 040-24455003
E-mail: e3hod.it@gmail.com,
Website: www.mist.ac.in,

MAHAVEER
INSTITUTE OF SCIENCE & TECHNOLOGY

Approved by AICTE, Affiliated to JNTUH,Hyd.

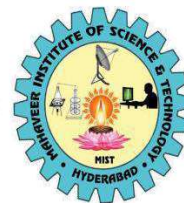

DEPARTMENT OF HUMANITIES AND SCIENCES

SYLLABUS FOR ULTRASONICS

SNO	TOPIC COVERED	DURATION
1	Introduction, Fundamentals of Ultrasonics	3
2	Features of Ultrasonic waves	3
3	Generation of Ultrasonics waves	3
4	Detection of Ultrasonic waves	3
5	Cavitations	3
6	Determination of velocity in a Liquid	3
7	Determination of velocity in Solids	3
8	Applications of Ultrasonics: Industrial, Medical, Marine	3

PRINCIPAL
MAHAVEER
INSTITUTE OF SCIENCE & TECHNOLOGY
Bandlaguda, Hyd-500 005.

HOD
Department of Humanities & Sciences
Mahaveer Institute of Science & Technology
HYDERABAD

Vysapuri, Bandlaguda Post:Keshavgi,ri,

Hyderabad-500 005, TELANGANA INDIA

Tel: 040-64596979,8978380692,Fax: 040-24455003

E-mail: e3hod.it@gmail.com,

Website: www.mist.ac.in,

MAHAVEER
INSTITUTE OF SCIENCE & TECHNOLOGY

Approved by AICTE, Affiliated to JNTUH,Hyd.

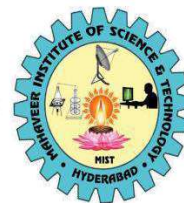

DEPARTMENT OF HUMANITIES AND SCIENCES

LIST OF REGISTERED STUDENTENS FOR ULTRASONICS

SNO	HOLL TICKET NO	NAME OF THE STUDENT
1	20E31A0402	A. AKSHAYA
2	20E31A0411	D. AKHILA
3	20E31A0424	J. SASHIDHAR
4	20E31A0456	Y. MAHESH REDDY
5	20E31A6610	L. HARI CHARAN
6	20E31A6611	MADDU AMEER SOHAIL
7	20E31A6625	P. SAI TEJASWINI
8	20E31A6628	SAHITH MANISANI
9	20E31A0203	B. SAI KRISHNA
10	20E31A0205	K.S. MOHAN TEJA
11	20E31A1215	M. SINDHUJA
12	20E31A1217	N. DHANALAXMI
13	20E31A0505	C. NANDINI
14	20E31A0509	G. VAISHNAVI
15	20E31A0546	SANA PUSHPANJALI
16	20E31A0559	MD. SARFARAZ
17	20E31A0105	DAIDA NAVEEN
18	20E31A0110	MD. BASHEER KHAN
19	20E31A0301	M. ARAVIND
20	20E31A0306	P. PAVAN
21	20E31A0308	SYED FARDEEN
22	20E31A0309	T. MITHUN KUMAR
23	20E31A2118	R. BHARATH
24	20E31A2127	Y. SAIKIRAN
25	20E31A2127	YALANGI SAI KIRAN

PRINCIPAL
MAHAVEER
INSTITUTE OF SCIENCE & TECHNOLOGY
Bandlaguda, Hyd-500 005.

HOD
Department of Humanities & Sciences
Mahaveer Institute of Science & Technology,
HYDERABAD

Vysapuri, Bandlaguda Post:Keshavgi,

Hyderabad-500 005, TELANGANA INDIA

Tel: 040-64596979,8978380692,Fax: 040-24455003

E-mail: e3hod.it@gmail.com,

Website: www.mist.ac.in,

MAHAVEER
INSTITUTE OF SCIENCE & TECHNOLOGY

Approved by AICTE, Affiliated to JNTUH,Hyd.

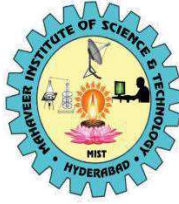

DEPARTMENT OF HUMANITIES AND SCIENCES

ULTRASONICS QUESTION PAPER

DURATION:120 MINUTES

MAX.MARKS 50

PART-A

ANSWER ANY TWO QUESTION.

2*15=30

- 1.Explain generation of ultrasonics?
- 2.Explain detection of ultra sonics?
- 3.Discuss different methods to find velocity of ultrasonics?

PART-B

ANSWER ANY TWO QUESTION.

2*10=20

- 4.Discuss applications of ultrasonics?
- 5.Explain pulse echo overlop technique?
- 6 Write the differences between ultrasonics and sound?

PRINCIPAL

MAHAVEER

INSTITUTE OF SCIENCE & TECHNOLOGY

Bandlaguda, Hyd-500 005.

Vysapuri, Bandlaguda Post:Keshavgi,

Hyderabad-500 005, TELANGANA INDIA

Tel: 040-64596979,8978380692,Fax: 040-24455003

E-mail: e3hod.it@gmail.com,

Website: www.mist.ac.in,

MAHAVEER
INSTITUTE OF SCIENCE & TECHNOLOGY

Approved by AICTE, Affiliated to JNTUH,Hyd.

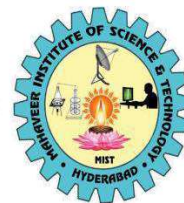

DEPARTMENT OF HUMANITIES AND SCIENCES

RESULT SHEET FOR ULTRASONICS REGISTERED STUDENTS

SNO	HOLL TICKET NO	NAME OF THE STUDENT	MARKS(20)	RESULT
1	20E31A0402	A. AKSHAYA	20	PASS
2	20E31A0411	D. AKHILA	19	PASS
3	20E31A0424	J. SASHIDHAR	20	PASS
4	20E31A0456	Y. MAHESH REDDY	18	PASS
5	20E31A6610	L. HARI CHARAN	20	PASS
6	20E31A6611	MADDU AMEER SOHAIL	19	PASS
7	20E31A6625	P. SAI TEJASWINI	18	PASS
8	20E31A6628	SAHITH MANISANI	20	PASS
9	20E31A0203	B. SAI KRISHNA	18	PASS
10	20E31A0205	K.S. MOHAN TEJA	18	PASS
11	20E31A1215	M. SINDHUJA	19	PASS
12	20E31A1217	N. DHANALAXMI	19	PASS
13	20E31A0505	C. NANDINI	20	PASS
14	20E31A0509	G. VAISHNAVI	20	PASS
15	20E31A0546	SANA PUSHPANJALI	20	PASS
16	20E31A0559	MD. SARFARAZ	19	PASS
17	20E31A0105	DAIDA NAVEEN	19	PASS
18	20E31A0110	MD. BASHEER KHAN	18	PASS
19	20E31A0301	M. ARAVIND	18	PASS
20	20E31A0306	P. PAVAN	20	PASS
21	20E31A0308	SYED FARDEEN	18	PASS
22	20E31A0309	T. MITHUN KUMAR	17	PASS
23	20E31A2118	R. BHARATH	16	PASS
24	20E31A2127	Y. SAIKIRAN	20	PASS
25	20E31A2127	YALANGI SAI KIRAN	19	PASS

No.of students registred:20

No.of students passed :20

No.of students failed :Nil

PRINCIPAL
MAHAVEER
INSTITUTE OF SCIENCE & TECHNOLOGY
Bandlaguda, Hyd-500 005.

Vysapuri, Bandlaguda Post:Keshavgiri,

Hyderabad-500 005, TELANGANA INDIA

Tel: 040-64596979,8978380692,Fax: 040-24455003

E-mail: e3hod.it@gmail.com,

Website: www.mist.ac.in,

MAHAVEER
INSTITUTE OF SCIENCE & TECHNOLOGY

Approved by AICTE, Affiliated to JNTUH,Hyd.



DEPARTMENT OF HUMANITIES AND SCIENCES

SUMMARY REPORT ON ADD ON COURSE(ULTRASONICS)

ultrasonics, Vibrational or stress waves in elastic media that have a frequency above 20 kilohertz, the highest frequency of sound waves that can be detected by the human ear. They can be generated or detected by piezoelectric transducers (*see* piezoelectricity). High-power ultrasonics produce distortion in a medium; applications include ultrasonic welding, drilling, irradiation of fluid suspensions (as in wine clarification), cleaning of surfaces (such as jewelry), and disruption of biological structures. Low-power ultrasonic waves do not cause distortions; uses include sonar, structure testing, and medical imaging and diagnosis. Some animals, including [bats](#), employ ultrasonic echolocation for navigation.

COPY TO:

- 1.Department notice board.
- 2.Principal for information
- 3.committee members (academic)

PRINCIPAL
MAHAVEER
INSTITUTE OF SCIENCE & TECHNOLOGY
Bandlaguda, Hyd-500 005.

**MAHAVEER INSTITUTE OF
SCIENCE AND TECHNOLOGY**
APPROVED BY AICTE AFFILIATED TO JNTUH - HYD.
DEPARTMENT OF
HUMANITIES AND SCIENCES



Certificate

This is to certify that Mr/Ms **P PAVAN** _____
bearing Hall Ticket No **20E31A0306** of B.Tech First Year
has participated In Certificate course on **ULTRASONICS**
From **20-09-20** to **12-10-20** organized by Dept. of
Humanities and Sciences

M. Ratika
HOD
Department of Humanities and Sciences
Mahaveer Institute of Science and Technology
Hyderabad

K. Srinivas
PRINCIPAL
MAHAVEER
INSTITUTE OF SCIENCE & TECHNOLOGY
Hyderabad, Telangana